

DUAL DIFFERENTIAL LINE DRIVER

1 Features

- Meets or exceeds the requirements of ANSI EIA/TIA-422-B and ITU recommendation V.11
- Single 5V supply
- Balanced-line operation
- TTL compatible
- High output impedance in power-off condition
- High-current active-pullup outputs
- Short-circuit protection
- Dual channels
- Input clamp diodes

2 Applications

- [Factory automation](#)
- ATM and cash counters
- [Smart grid](#)
- AC and [servo motor drives](#)

3 Description

The SN75158 is a dual differential line driver designed to satisfy the requirements set by the ANSI EIA/TIA-422-B and ITU V.11 interface specifications. The outputs provide signals with high-current capability for driving balanced lines, such as twisted pair, at normal line impedance without high power dissipation. The output stages are TTL totem-pole outputs, providing a high-impedance state in the power-off condition.

The SN75158 is characterized for operation from 0°C to 70°C.

Package Information

PART NUMBER	PACKAGE ⁽¹⁾	PACKAGE SIZE ⁽²⁾
SN75158	SOIC (D, 8)	4.9mm × 6mm
	PDIP (P, 8)	9.81mm × 9.43mm
	SOP (PS, 8)	6.2mm × 7.8mm

(1) For more information, see [Section 8](#).

(2) The package size (length × width) is a nominal value and includes pins, where applicable.

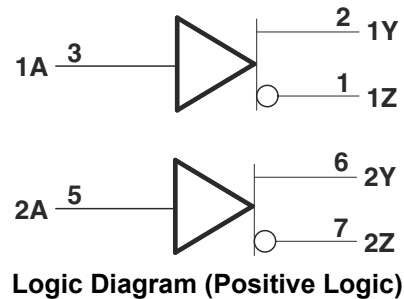
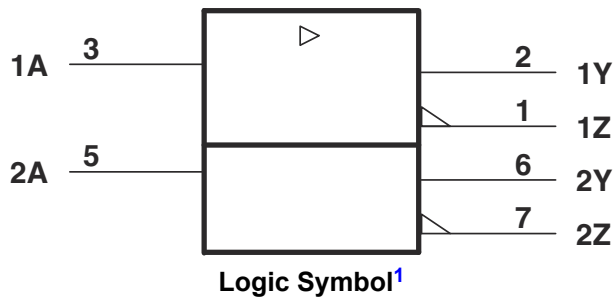

¹ This symbol is in accordance with ANSI/IEEE Std 91-1984 and IEC Publication 617-12.



Table of Contents

1 Features	1	5.7 Typical Characteristics.....	6
2 Applications	1	Parameter Measurement Information	9
3 Description	1	6 Device and Documentation Support	10
4 Pin Configuration and Functions	3	6.1 Receiving Notification of Documentation Updates....	10
5 Specifications	4	6.2 Support Resources.....	10
5.1 Absolute Maximum Ratings.....	4	6.3 Trademarks.....	10
5.2 Dissipation Ratings.....	4	6.4 Electrostatic Discharge Caution.....	10
5.3 Recommended Operating Conditions.....	4	6.5 Glossary.....	10
5.4 Thermal Information.....	4	7 Revision History	10
5.5 Electrical Characteristics.....	5	8 Mechanical, Packaging, and Orderable Information..	10
5.6 Switching Characteristics.....	5		

4 Pin Configuration and Functions

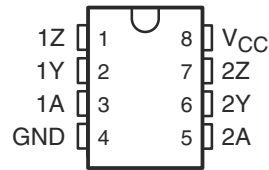

Figure 4-1. D, P, OR PS Package (Top View)

Table 4-1. Pin Functions

PIN		TYPE ⁽¹⁾	DESCRIPTION
NAME	NO.		
1Z	1	O	Inverting Output of Differential Driver on Channel 1
1Y	2	O	Non-Inverting Output for Differential Driver on Channel 1
1A	3	I	Single Ended Data Input for Channel 1
GND	4	GND	Device Ground
2A	5	I	Single Ended Data Input for Channel 2
2Y	6	O	Non-Inverting Output for Differential Driver on Channel 2
2Z	7	O	Inverting Output of Differential Driver on Channel 2
V _{CC}	8	P	5V Power Supply Positive Terminal Connection

(1) Signal Types: I = Input, O = Output, I/O = Input or Output, P = Power, GND = Ground.

5 Specifications

5.1 Absolute Maximum Ratings

over operating free-air temperature range (unless otherwise noted) ⁽¹⁾

		MIN	MAX	UNIT
V _{CC}	Supply voltage ⁽²⁾		7	V
V _I	Input voltage range		5.5	V
	Continuous total power dissipation	See Dissipation Ratings		
T _J	Operating free-air temperature range	0	70	°C
T _{stg}	Storage temperature range	–65	150	°C
	Lead temperature 1,6 mm (1/16 inch) from case for 10 s		260	°C

- (1) Stresses beyond those listed under "absolute maximum ratings" may cause permanent damage to the device. These are stress ratings only, and functional operation of the device at these or any other conditions beyond those indicated under "recommended operating conditions" is not implied. Exposure to absolute-maximum-rated conditions for extended periods may affect device reliability.
- (2) All voltage values, except differential input voltage, are with respect to the network ground terminal.
- (3) Differential input voltage is measured at the noninverting input with respect to the corresponding inverting input.

5.2 Dissipation Ratings

PACKAGE	TA ≤ 25°C POWER RATING	OPERATING FACTOR ABOVE TA = 25°C	TA ≤ 70°C POWER RATING
D	725 mW	5.8 mW/°C	464 mW
P	1000 mW	8.0 mW/°C	640 mW
PS	450 mW	3.6 mW/°C	288 mW

5.3 Recommended Operating Conditions

		MIN	NOM	MAX	UNIT
V _{CC}	Supply voltage	4.75	5	5.25	V
V _{IH}	High-level input voltage	2			V
V _{IL}	Low-level input voltage			0.8	V
I _{OH}	High-level output current			–40	mA
I _{OL}	Low-level output current			40	mA
T _A	Operating free-air temperature	0		70	°C

5.4 Thermal Information

THERMAL METRIC ⁽¹⁾		D	P	PS	UNIT
		8-Pins			
R _{θJA}	Junction-to-ambient thermal resistance	116.7	84.3	89.5	°C/W
R _{θJC(top)}	Junction-to-case (top) thermal resistance	56.3	65.4	46.2	°C/W
R _{θJB}	Junction-to-board thermal resistance	63.4	62.1	50.7	°C/W
ψ _{JT}	Junction-to-top characterization parameter	8.8	31.3	23.5	°C/W
ψ _{JB}	Junction-to-board characterization parameter	62.6	60.4	60.3	°C/W
R _{θJC(bot)}	Junction-to-case (bottom) thermal resistance	N/A	N/A	N/A	°C/W

- (1) For more information about traditional and new thermal metrics, see the [Semiconductor and IC package thermal metrics](#) application report.

5.5 Electrical Characteristics

over recommended ranges of supply voltage, common-mode input voltage, and operating free-air temperature (unless otherwise noted)

PARAMETER		TEST CONDITIONS ⁽¹⁾		MIN	TYP ⁽²⁾	MAX	UNIT	
V _{IK}	Input clamp voltage	V _{CC} = MIN,	I _I = -12mA		-0.9	-1.5	V	
V _{OH}	High-level output voltage	V _{CC} = MIN, V _{IH} = 2V,	V _{IL} = 0.8V, I _{OH} = -40mA	2.4	3		V	
V _{OL}	Low-level output voltage	V _{CC} = MIN, V _{IH} = 2V,	V _{IL} = 0.8V, I _{OH} = 40mA		0.2	0.4	V	
V _{OD1}	Differential output voltage	V _{CC} = MAX,	I _O = 0		3.5	2 × V _{OD2}	V	
V _{OD2}		V _{CC} = MIN,	R _L = 100Ω, See Figure 6-1		3	3	V	
ΔV _{OD}	Change in magnitude of differential output voltage ⁽³⁾	V _{CC} = MIN,	R _L = 100Ω, See Figure 6-1		±0.02	±0.4	V	
V _{OC}	Common-mode output voltage ⁽⁴⁾	V _{CC} = MAX,	R _L = 100Ω, See Figure 6-1		1.8	3	V	
		V _{CC} = MIN,				1.5		3
ΔV _{OC}	Change in magnitude of common-mode output voltage ⁽³⁾	V _{CC} = MIN or MAX,	R _L = 100Ω, See Figure 6-1		±0.02	±0.4	V	
I _O	Output current with power off	V _{CC} = 0,	V _O = 6V		0.1	100	μA	
			V _O = -0.25V		-0.1	-100		
			V _O = -0.25 to 6V			±100		
I _I	Input current at maximum input voltage	V _{CC} = MAX,	V _I = 5.5V				1	mA
I _{IH}	High-level input current	V _{CC} = MAX,	V _I = 2.4V				40	μA
I _{IL}	Low-level input current	V _{CC} = MAX,	V _I = 0.4V		-1	-1.6		mA
I _{OS}	Short-circuit output current ⁽⁵⁾	V _{CC} = MAX,		-40	-90	-150		mA
I _{CC}	Supply current (both drivers)	V _{CC} = MAX, T _A = 25°C,	Inputs grounded, No load		37	50		mA

- (1) For conditions shown as MIN or MAX, use the appropriate value specified under [Recommended Operating Conditions](#).
- (2) All typical values are at V_{CC} = 5 V and T_A = 25°C except for V_{OC}, for which V_{CC} is as stated under test conditions.
- (3) ΔV_{OD} and Δ|V_{OC}| are the changes in magnitudes of V_{OD} and V_{OC}, respectively, that occur when the input is changed from a high level to a low level.
- (4) In ANSI Standard EIA/TIA-422-B, V_{OC}, which is the average of the two output voltages with respect to ground, is called output offset voltage, V_{OS}.
- (5) Only one output should be shorted at a time, and duration of the short circuit should not exceed one second.

5.6 Switching Characteristics

V_{CC} = 5V, T_A = 25°C

PARAMETER		TEST CONDITIONS		MIN	TYP	MAX	UNIT
t _{PLH}	Propagation delay time, low- to high-level output	See Figure 6-2	Termination A		16	25	ns
			Termination B		13	20	
t _{PHL}	Propagation delay time, high- to low-level output	See Figure 6-2	Termination A		10	20	ns
			Termination B		9	15	
t _{TLH}	Transition time, low-to-high-level output	See Figure 6-2	Termination A		4	20	ns
t _{THL}	Transition time, high- to low-level output	See Figure 6-2	Termination A		4	20	ns
	Overshoot factor	See Figure 6-2	Termination C			10	%

5.7 Typical Characteristics

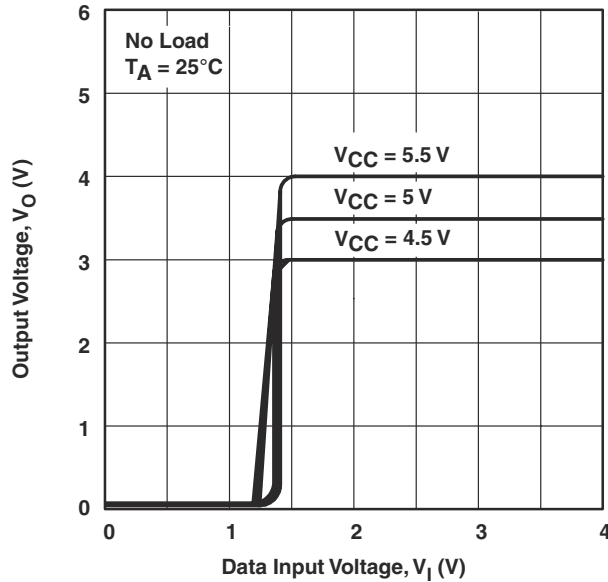

Figure 5-1. Output Voltage vs Data Input Voltage

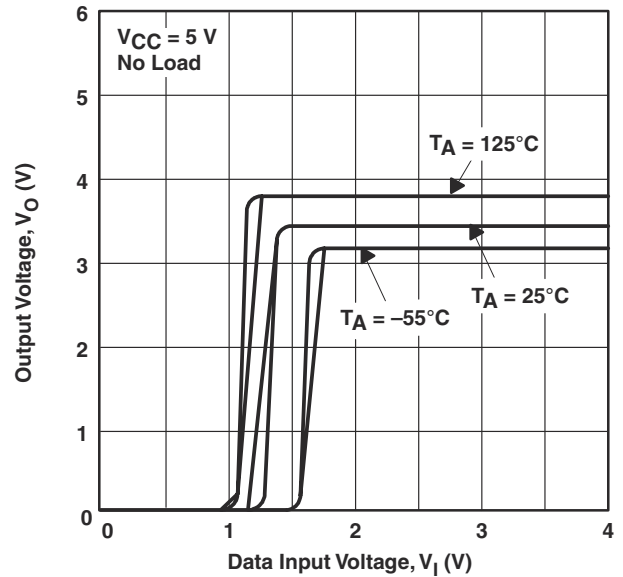

Figure 5-2. Output Voltage vs DATA Input Voltage

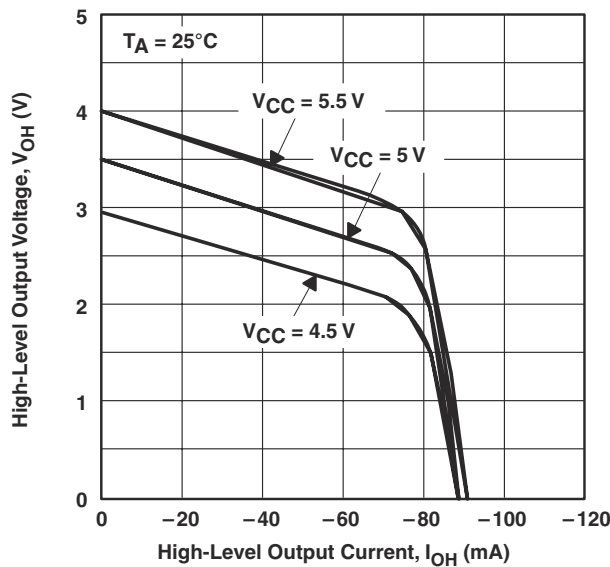

Figure 5-3. High-Level Output Voltage vs High-Level Output Current

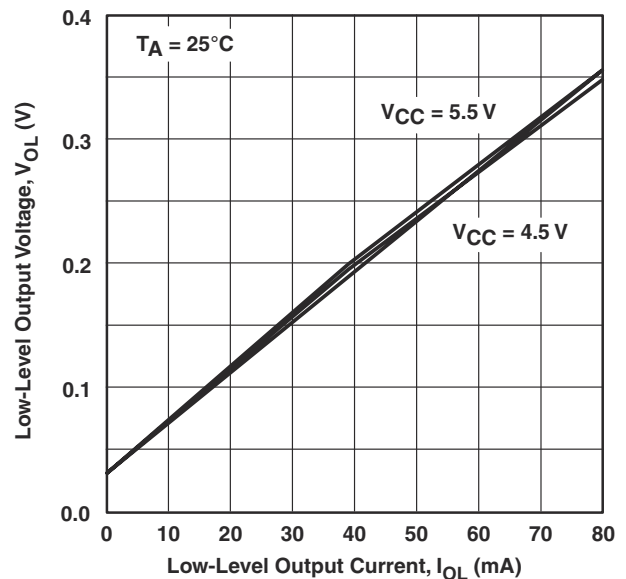

Figure 5-4. Low-Level Output Voltage vs Low-Level Output Current

5.7 Typical Characteristics (continued)

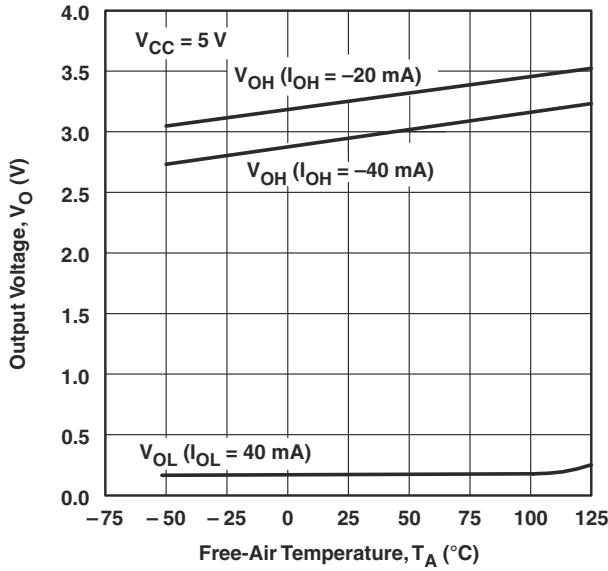

Figure 5-5. Output Voltage vs Free-Air Temperature

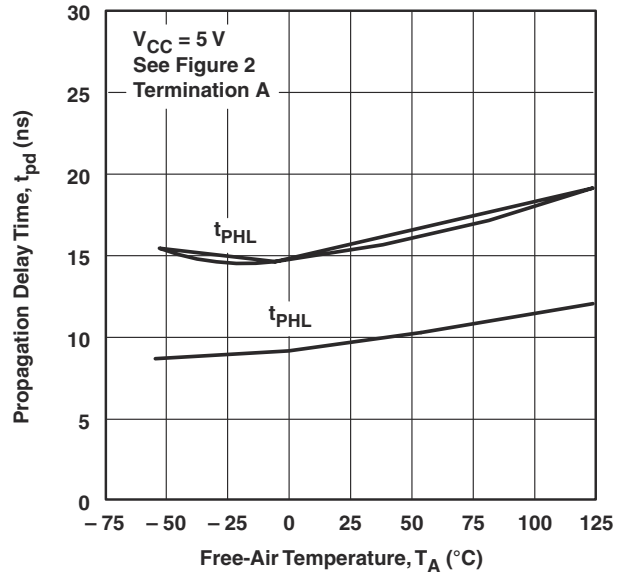

Figure 5-6. Propagation Delay Times vs Free-Air Temperature

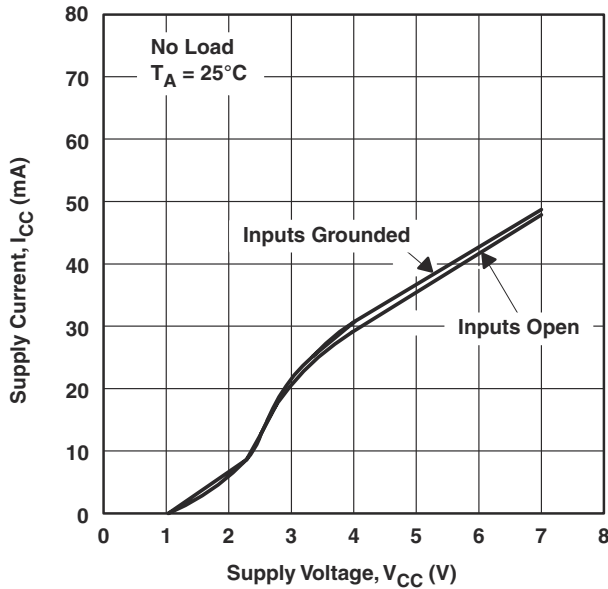

Figure 5-7. Supply Current(Both Drivers) vs Supply Voltage

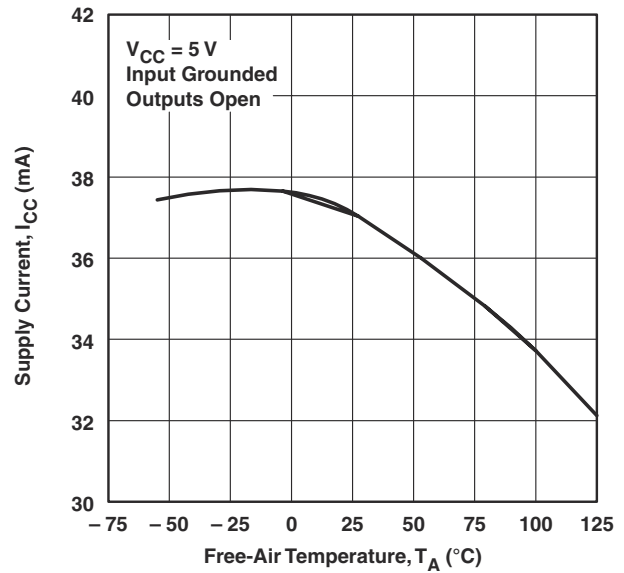

Figure 5-8. Supply Current(Both Drivers) vs Free-Air Temperature

5.7 Typical Characteristics (continued)

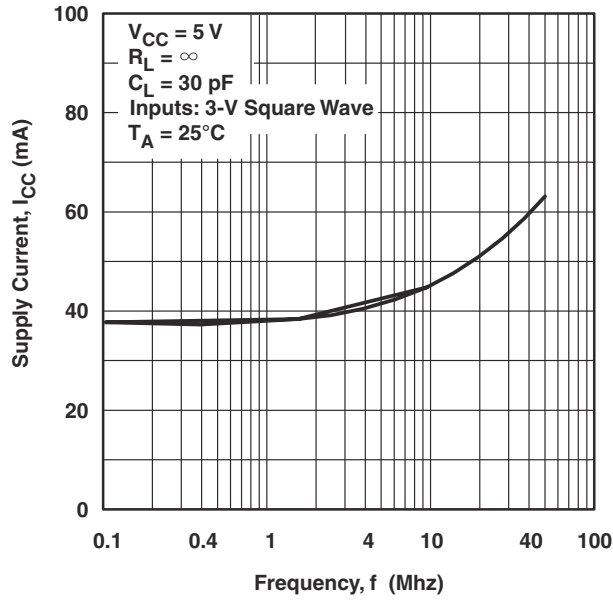

Figure 5-9. Supply Current(Both Drivers) vs Frequency

Parameter Measurement Information

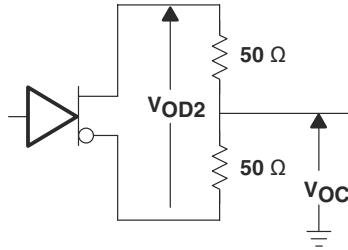
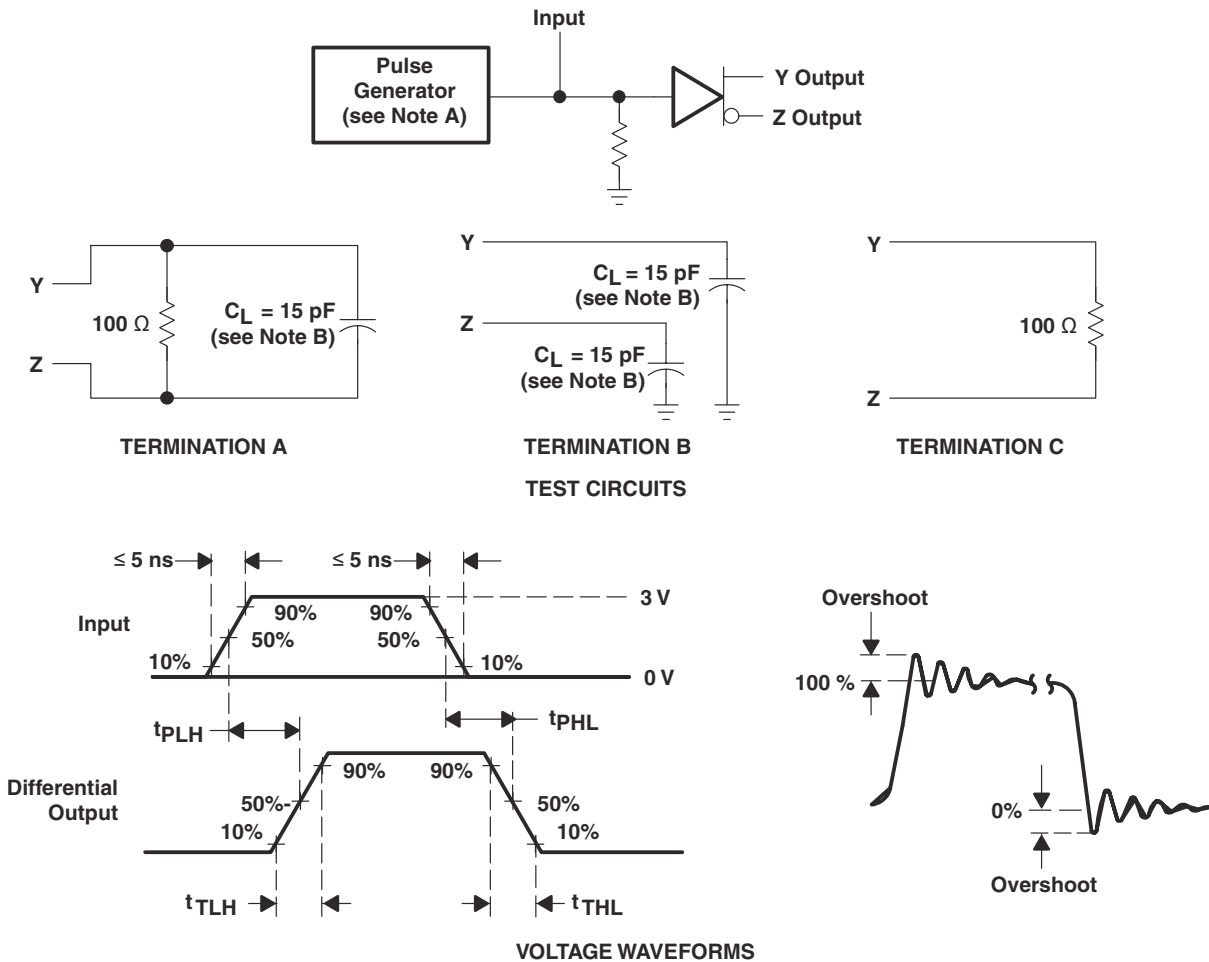

Figure 6-1. Differential and Common-Mode Output Voltages



- A. The input pulse is supplied by a generator having the following characteristics: $Z_O = 50\Omega$, $t_w = 25\text{ns}$, $\text{PRR} \leq 10\text{MHz}$.
- B. C_L includes probe and jig capacitance.

Figure 6-2. Test Circuit and Voltage Waveforms

6 Device and Documentation Support

TI offers an extensive line of development tools. Tools and software to evaluate the performance of the device, generate code, and develop solutions are listed below.

6.1 Receiving Notification of Documentation Updates

To receive notification of documentation updates, navigate to the device product folder on ti.com. Click on *Notifications* to register and receive a weekly digest of any product information that has changed. For change details, review the revision history included in any revised document.

6.2 Support Resources

[TI E2E™ support forums](#) are an engineer's go-to source for fast, verified answers and design help — straight from the experts. Search existing answers or ask your own question to get the quick design help you need.

Linked content is provided "AS IS" by the respective contributors. They do not constitute TI specifications and do not necessarily reflect TI's views; see TI's [Terms of Use](#).

6.3 Trademarks

TI E2E™ is a trademark of Texas Instruments.

All trademarks are the property of their respective owners.

6.4 Electrostatic Discharge Caution



This integrated circuit can be damaged by ESD. Texas Instruments recommends that all integrated circuits be handled with appropriate precautions. Failure to observe proper handling and installation procedures can cause damage.

ESD damage can range from subtle performance degradation to complete device failure. Precision integrated circuits may be more susceptible to damage because very small parametric changes could cause the device not to meet its published specifications.

6.5 Glossary

[TI Glossary](#) This glossary lists and explains terms, acronyms, and definitions.

7 Revision History

NOTE: Page numbers for previous revisions may differ from page numbers in the current version.

Changes from Revision B (May 1995) to Revision C (March 2024)	Page
• Changed the numbering format for tables, figures, and cross-references throughout the document.....	1

8 Mechanical, Packaging, and Orderable Information

The following pages include mechanical, packaging, and orderable information. This information is the most current data available for the designated devices. This data is subject to change without notice and revision of this document. For browser-based versions of this data sheet, refer to the left-hand navigation.

PACKAGING INFORMATION

Orderable part number	Status (1)	Material type (2)	Package Pins	Package qty Carrier	RoHS (3)	Lead finish/ Ball material (4)	MSL rating/ Peak reflow (5)	Op temp (°C)	Part marking (6)
SN75158D	Obsolete	Production	SOIC (D) 8	-	-	Call TI	Call TI	0 to 70	75158
SN75158DR	Active	Production	SOIC (D) 8	2500 LARGE T&R	Yes	NIPDAU	Level-1-260C-UNLIM	0 to 70	75158
SN75158DR.A	Active	Production	SOIC (D) 8	2500 LARGE T&R	Yes	NIPDAU	Level-1-260C-UNLIM	0 to 70	75158
SN75158P	Active	Production	PDIP (P) 8	50 TUBE	Yes	NIPDAU	N/A for Pkg Type	0 to 70	SN75158P
SN75158P.A	Active	Production	PDIP (P) 8	50 TUBE	Yes	NIPDAU	N/A for Pkg Type	0 to 70	SN75158P
SN75158PSR	Active	Production	SO (PS) 8	2000 LARGE T&R	Yes	NIPDAU NIPDAU	Level-1-260C-UNLIM	0 to 70	A158
SN75158PSR.A	Active	Production	SO (PS) 8	2000 LARGE T&R	Yes	NIPDAU	Level-1-260C-UNLIM	0 to 70	A158

(1) **Status:** For more details on status, see our [product life cycle](#).

(2) **Material type:** When designated, preproduction parts are prototypes/experimental devices, and are not yet approved or released for full production. Testing and final process, including without limitation quality assurance, reliability performance testing, and/or process qualification, may not yet be complete, and this item is subject to further changes or possible discontinuation. If available for ordering, purchases will be subject to an additional waiver at checkout, and are intended for early internal evaluation purposes only. These items are sold without warranties of any kind.

(3) **RoHS values:** Yes, No, RoHS Exempt. See the [TI RoHS Statement](#) for additional information and value definition.

(4) **Lead finish/Ball material:** Parts may have multiple material finish options. Finish options are separated by a vertical ruled line. Lead finish/Ball material values may wrap to two lines if the finish value exceeds the maximum column width.

(5) **MSL rating/Peak reflow:** The moisture sensitivity level ratings and peak solder (reflow) temperatures. In the event that a part has multiple moisture sensitivity ratings, only the lowest level per JEDEC standards is shown. Refer to the shipping label for the actual reflow temperature that will be used to mount the part to the printed circuit board.

(6) **Part marking:** There may be an additional marking, which relates to the logo, the lot trace code information, or the environmental category of the part.

Multiple part markings will be inside parentheses. Only one part marking contained in parentheses and separated by a "-" will appear on a part. If a line is indented then it is a continuation of the previous line and the two combined represent the entire part marking for that device.

Important Information and Disclaimer: The information provided on this page represents TI's knowledge and belief as of the date that it is provided. TI bases its knowledge and belief on information provided by third parties, and makes no representation or warranty as to the accuracy of such information. Efforts are underway to better integrate information from third parties. TI has taken and continues to take reasonable steps to provide representative and accurate information but may not have conducted destructive testing or chemical analysis on incoming materials and chemicals. TI and TI suppliers consider certain information to be proprietary, and thus CAS numbers and other limited information may not be available for release.

In no event shall TI's liability arising out of such information exceed the total purchase price of the TI part(s) at issue in this document sold by TI to Customer on an annual basis.

TAPE AND REEL INFORMATION

QUADRANT ASSIGNMENTS FOR PIN 1 ORIENTATION IN TAPE

*All dimensions are nominal

Device	Package Type	Package Drawing	Pins	SPQ	Reel Diameter (mm)	Reel Width W1 (mm)	A0 (mm)	B0 (mm)	K0 (mm)	P1 (mm)	W (mm)	Pin1 Quadrant
SN75158DR	SOIC	D	8	2500	330.0	12.4	6.4	5.2	2.1	8.0	12.0	Q1
SN75158DR	SOIC	D	8	2500	330.0	12.4	6.4	5.2	2.1	8.0	12.0	Q1
SN75158PSR	SO	PS	8	2000	330.0	16.4	8.35	6.6	2.4	12.0	16.0	Q1
SN75158PSR	SO	PS	8	2000	330.0	16.4	8.35	6.6	2.4	12.0	16.0	Q1

TAPE AND REEL BOX DIMENSIONS



*All dimensions are nominal

Device	Package Type	Package Drawing	Pins	SPQ	Length (mm)	Width (mm)	Height (mm)
SN75158DR	SOIC	D	8	2500	340.5	336.1	25.0
SN75158DR	SOIC	D	8	2500	353.0	353.0	32.0
SN75158PSR	SO	PS	8	2000	353.0	353.0	32.0
SN75158PSR	SO	PS	8	2000	356.0	356.0	35.0

TUBE

*All dimensions are nominal

Device	Package Name	Package Type	Pins	SPQ	L (mm)	W (mm)	T (μm)	B (mm)
SN75158P	P	PDIP	8	50	506	13.97	11230	4.32
SN75158P.A	P	PDIP	8	50	506	13.97	11230	4.32



D0008A

PACKAGE OUTLINE

SOIC - 1.75 mm max height

SMALL OUTLINE INTEGRATED CIRCUIT



4214825/C 02/2019

NOTES:

1. Linear dimensions are in inches [millimeters]. Dimensions in parenthesis are for reference only. Controlling dimensions are in inches. Dimensioning and tolerancing per ASME Y14.5M.
2. This drawing is subject to change without notice.
3. This dimension does not include mold flash, protrusions, or gate burrs. Mold flash, protrusions, or gate burrs shall not exceed $.006$ [0.15] per side.
4. This dimension does not include interlead flash.
5. Reference JEDEC registration MS-012, variation AA.

EXAMPLE BOARD LAYOUT

D0008A

SOIC - 1.75 mm max height

SMALL OUTLINE INTEGRATED CIRCUIT



LAND PATTERN EXAMPLE
 EXPOSED METAL SHOWN
 SCALE:8X



SOLDER MASK DETAILS

4214825/C 02/2019

NOTES: (continued)

- 6. Publication IPC-7351 may have alternate designs.
- 7. Solder mask tolerances between and around signal pads can vary based on board fabrication site.

EXAMPLE STENCIL DESIGN

D0008A

SOIC - 1.75 mm max height

SMALL OUTLINE INTEGRATED CIRCUIT



SOLDER PASTE EXAMPLE
BASED ON .005 INCH [0.125 MM] THICK STENCIL
SCALE:8X

4214825/C 02/2019

NOTES: (continued)

8. Laser cutting apertures with trapezoidal walls and rounded corners may offer better paste release. IPC-7525 may have alternate design recommendations.
9. Board assembly site may have different recommendations for stencil design.

MECHANICAL DATA

PS (R-PDSO-G8)

PLASTIC SMALL-OUTLINE PACKAGE

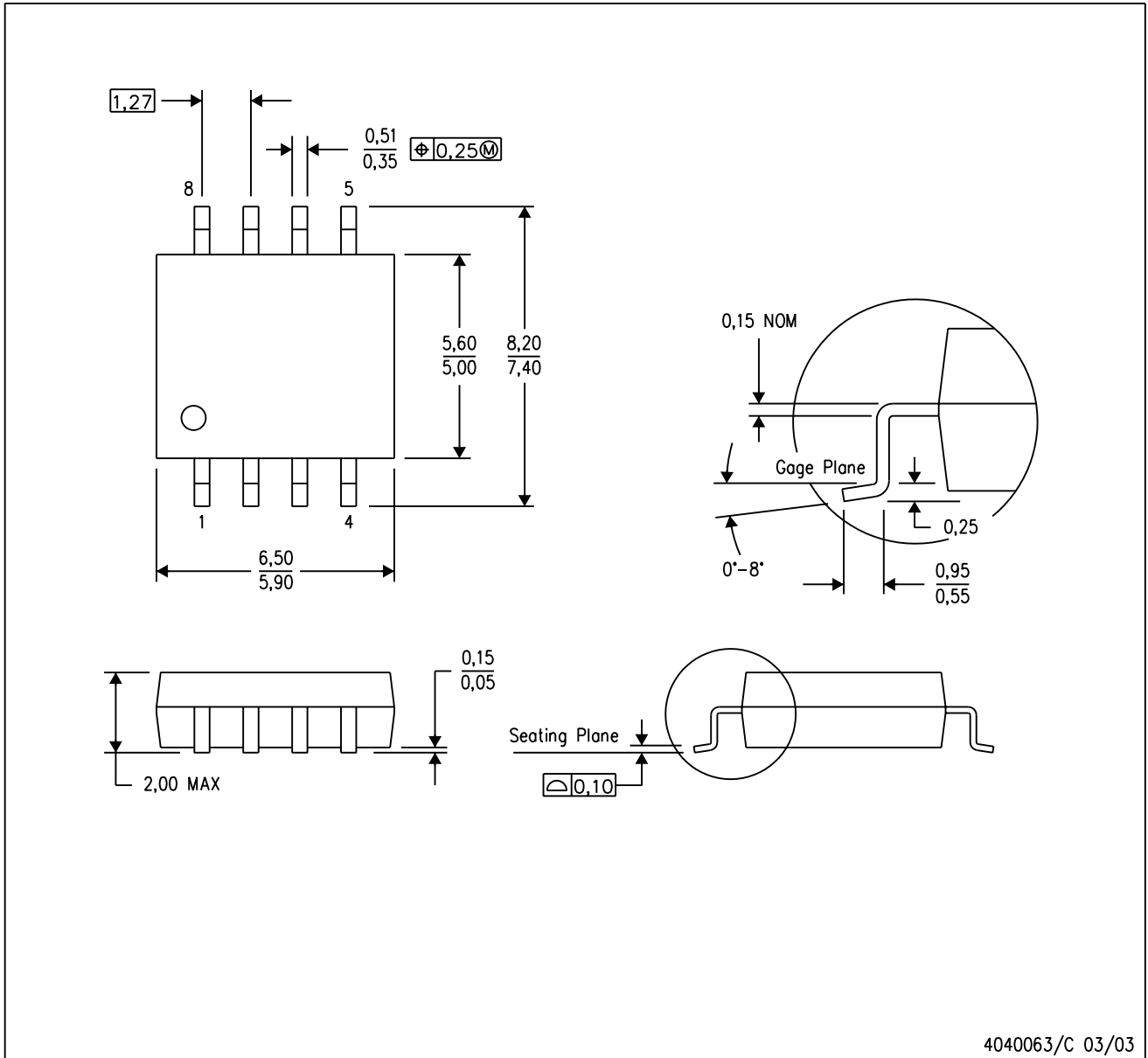

- NOTES:
- A. All linear dimensions are in millimeters.
 - B. This drawing is subject to change without notice.
 - C. Body dimensions do not include mold flash or protrusion, not to exceed 0,15.

PS (R-PDSO-G8)

PLASTIC SMALL OUTLINE

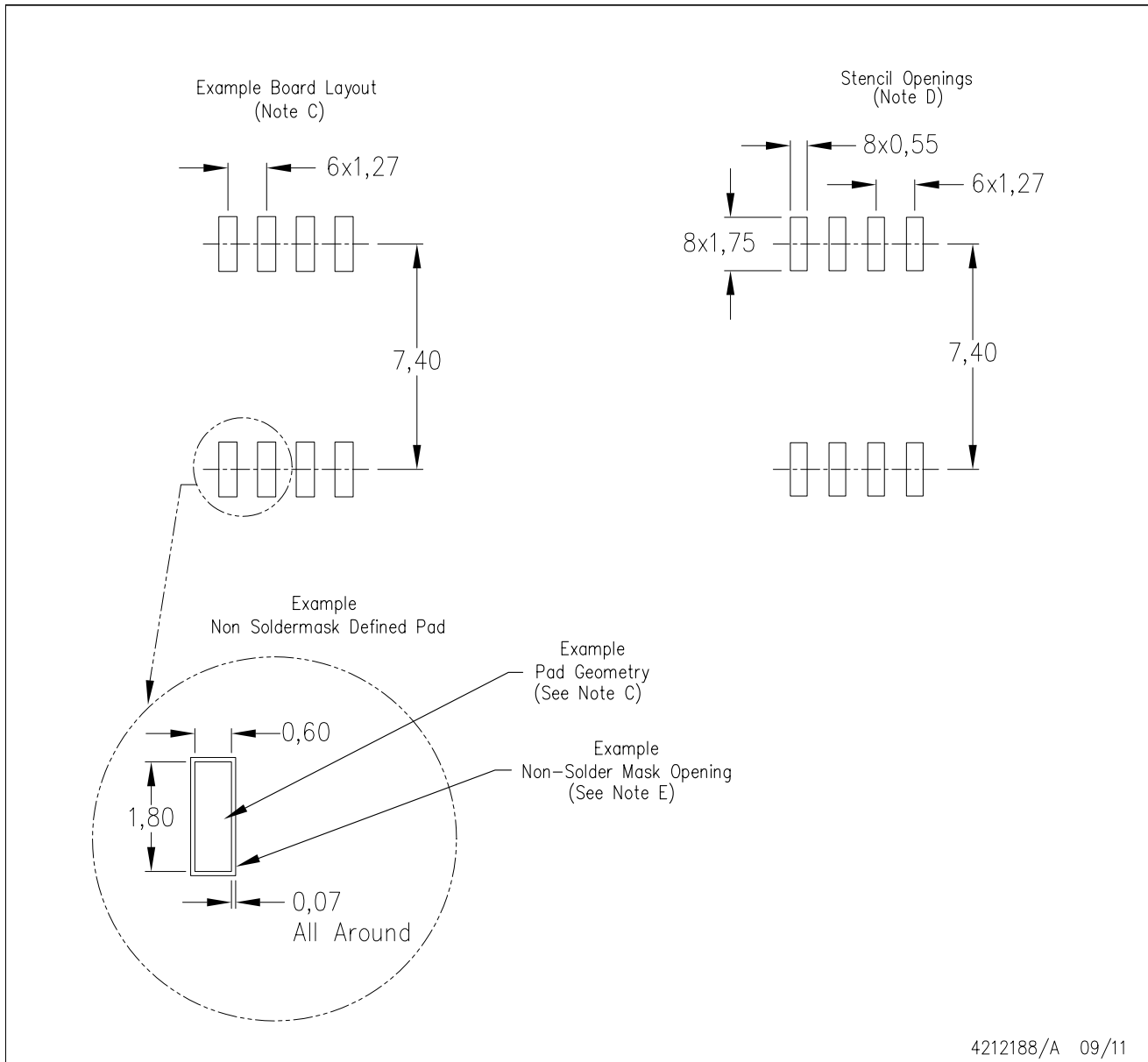

- NOTES:
- All linear dimensions are in millimeters.
 - This drawing is subject to change without notice.
 - Publication IPC-7351 is recommended for alternate designs.
 - Laser cutting apertures with trapezoidal walls and also rounding corners will offer better paste release. Customers should contact their board assembly site for stencil design recommendations. Refer to IPC-7525 for other stencil recommendations.
 - Customers should contact their board fabrication site for solder mask tolerances between and around signal pads.

P (R-PDIP-T8)

PLASTIC DUAL-IN-LINE PACKAGE



- NOTES:
- A. All linear dimensions are in inches (millimeters).
 - B. This drawing is subject to change without notice.
 - C. Falls within JEDEC MS-001 variation BA.

IMPORTANT NOTICE AND DISCLAIMER

TI PROVIDES TECHNICAL AND RELIABILITY DATA (INCLUDING DATA SHEETS), DESIGN RESOURCES (INCLUDING REFERENCE DESIGNS), APPLICATION OR OTHER DESIGN ADVICE, WEB TOOLS, SAFETY INFORMATION, AND OTHER RESOURCES "AS IS" AND WITH ALL FAULTS, AND DISCLAIMS ALL WARRANTIES, EXPRESS AND IMPLIED, INCLUDING WITHOUT LIMITATION ANY IMPLIED WARRANTIES OF MERCHANTABILITY, FITNESS FOR A PARTICULAR PURPOSE OR NON-INFRINGEMENT OF THIRD PARTY INTELLECTUAL PROPERTY RIGHTS.

These resources are intended for skilled developers designing with TI products. You are solely responsible for (1) selecting the appropriate TI products for your application, (2) designing, validating and testing your application, and (3) ensuring your application meets applicable standards, and any other safety, security, regulatory or other requirements.

These resources are subject to change without notice. TI grants you permission to use these resources only for development of an application that uses the TI products described in the resource. Other reproduction and display of these resources is prohibited. No license is granted to any other TI intellectual property right or to any third party intellectual property right. TI disclaims responsibility for, and you will fully indemnify TI and its representatives against, any claims, damages, costs, losses, and liabilities arising out of your use of these resources.

TI's products are provided subject to [TI's Terms of Sale](#) or other applicable terms available either on [ti.com](https://www.ti.com) or provided in conjunction with such TI products. TI's provision of these resources does not expand or otherwise alter TI's applicable warranties or warranty disclaimers for TI products.

TI objects to and rejects any additional or different terms you may have proposed.

Mailing Address: Texas Instruments, Post Office Box 655303, Dallas, Texas 75265

Copyright © 2025, Texas Instruments Incorporated