

TLV743P 300-mA, Low-Dropout Regulator

1 Features

- Input Voltage Range: 1.4 V to 5.5 V
- Stable Operation With 1- μ F Ceramic Output Capacitor
- Foldback Overcurrent Protection
- Packages:
 - SOT-23 (5)
 - X2SON (4)
- Very Low Dropout: 125 mV at 300 mA (3.3 V_{OUT})
- Accuracy: 1% (Typical), 1.4% (Maximum)
- Low I_Q: 34 μ A
- Available in Fixed-Output Voltages: 1 V to 3.3 V
- High PSRR: 50 dB at 1 kHz
- Active Output Discharge

2 Applications

- Tablets
- Smartphones
- Notebook and Desktop Computers
- Portable Industrial and Consumer Products
- WLAN and Other PC Add-On Cards
- Camera Modules

3 Description

The TLV743P low-dropout linear regulator (LDO) is an ultra-small, low quiescent current LDO that sources 300 mA with good line and load transient performance. The device provides a typical accuracy of 1%.

The TLV743P is designed to be stable with a small output capacitor with a value of 1 μ F. The TLV743P device provides foldback current control during device power up and enabling. This functionality is especially important in battery-operated devices.

The TLV743P provides an active pulldown circuit to quickly discharge output loads when the device is disabled.

The TLV743P is available in standard DBV (SOT-23) and DQN (X2SON) packages.

Device Information⁽¹⁾

PART NUMBER	PACKAGE	BODY SIZE (NOM)
TLV743P	SOT-23 (5)	2.90 mm x 1.60 mm
	X2SON (4)	1.00 mm x 1.00 mm

(1) For all available packages, see the package option addendum at the end of the data sheet.

Typical Application Circuit

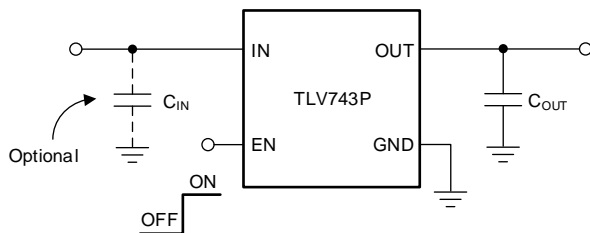

Dropout Voltage vs Output Current

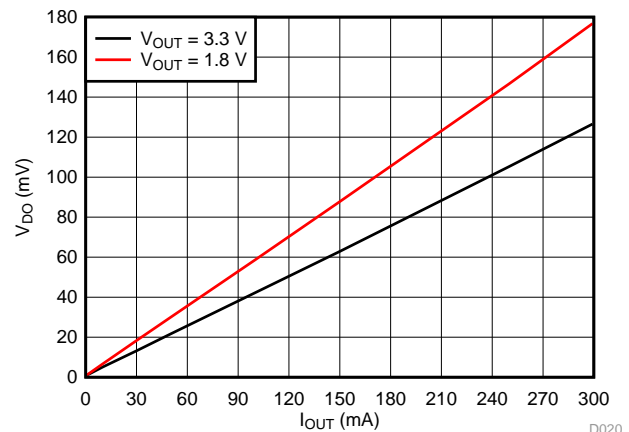

D020



Table of Contents

1 Features	1	8 Application and Implementation	16
2 Applications	1	8.1 Application Information.....	16
3 Description	1	8.2 Typical Application	18
4 Revision History	2	9 Power Supply Recommendations	19
5 Pin Configuration and Functions	4	10 Layout	19
6 Specifications	5	10.1 Layout Guidelines	19
6.1 Absolute Maximum Ratings	5	10.2 Layout Examples.....	19
6.2 ESD Ratings.....	5	11 Device and Documentation Support	20
6.3 Recommended Operating Conditions.....	5	11.1 Device Support	20
6.4 Thermal Information	5	11.2 Documentation Support	20
6.5 Electrical Characteristics.....	6	11.3 Receiving Notification of Documentation Updates	20
6.6 Typical Characteristics	8	11.4 Community Resources.....	20
7 Detailed Description	13	11.5 Trademarks	21
7.1 Overview	13	11.6 Electrostatic Discharge Caution.....	21
7.2 Functional Block Diagram	13	11.7 Glossary	21
7.3 Feature Description.....	14	12 Mechanical, Packaging, and Orderable	21
7.4 Device Functional Modes.....	15	Information	21

4 Revision History

Changes from Revision B (March 2018) to Revision C	Page
• Changed description of EN pin in <i>Pin Functions</i> table	4
• Deleted typical specification from $V_{EN(HI)}$ and $V_{EN(LO)}$ parameters	6
• Added maximum specification to I_{LIM} parameter	7
• Added condition to <i>1-V Load Regulation vs I_{OUT} and Temperature</i> figure	8
• Added condition to <i>1.8-V Load Regulation vs I_{OUT} and Temperature</i> figure	8
• Added condition to <i>3.3-V Load Regulation vs I_{OUT} and Temperature</i> figure	8
• Added condition to <i>1.2-V Dropout Voltage vs I_{OUT} and Temperature</i> figure	9
• Added condition to <i>1.8-V Dropout Voltage vs I_{OUT} and Temperature</i> figure	9
• Added condition to <i>3.3-V Dropout Voltage vs I_{OUT} and Temperature</i> figure	9
• Added <i>and Output Enable</i> to title and changed first paragraph of <i>Shutdown and Output Enable</i> section	14
• Added DBV package to <i>Maximum Ambient Temperature vs Device Power Dissipation</i> figure and text reference.....	17
• Added (3) to <i>Device Nomenclature</i> table	20

Changes from Revision A (January 2018) to Revision B	Page
• Changed X2SON package from preview to production data (active)	1

Changes from Original (July 2017) to Revision A	Page
• Added X2SON package to <i>Features</i> list	1
• Added DQN (X2SON) package to <i>Description</i> section	1
• Added X2SON package to <i>Device Information</i> table	1
• Added DQN (X2SON) package pinout drawing and pin functions table to <i>Pin Configuration and Functions</i> section	4
• Deleted thermal pad from DBV pinout drawing and <i>Pin Functions</i> table	4
• Changed format of I/O column contents and order of packages in <i>Pin Functions</i> table	4
• Added DQN (X2SON) thermal information to <i>Thermal Information</i> table	5
• Changed condition text for Figure 31	17

-
- Added X2SON layout example image to *Layout Examples* section 19
-

5 Pin Configuration and Functions

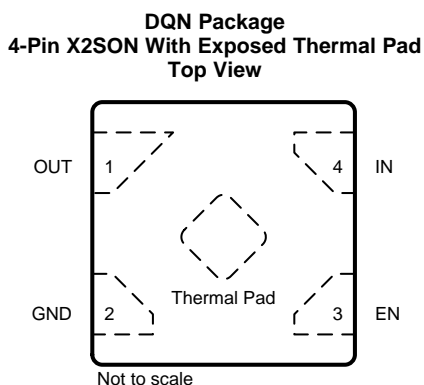
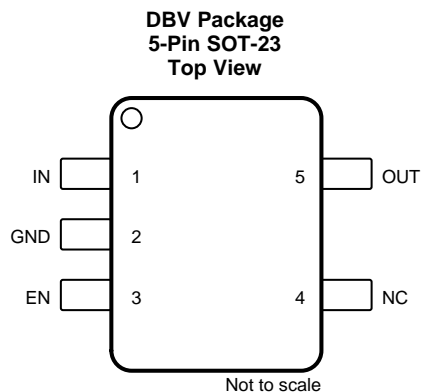

Pin Functions

NAME	PIN		I/O	DESCRIPTION
	SOT-23	X2SON		
EN	3	3	I	Enable pin. Drive EN greater than $V_{EN(LO)}$ to turn on the regulator. Drive EN less than $V_{EN(LO)}$ to put the LDO into shutdown mode.
GND	2	2	—	Ground pin
IN	1	4	I	Input pin. A small capacitor is recommended from this pin to ground. See Input and Output Capacitor Selection for more details.
NC	4		—	No internal connection
OUT	5	1	O	Regulated output voltage pin. For best transient response, use a small 1- μ F ceramic capacitor from this pin to ground. See Input and Output Capacitor Selection for more details.
Thermal pad	—	Thermal pad	—	The thermal pad is electrically connected to the GND node. Connect to the GND plane for improved thermal performance.

6 Specifications

6.1 Absolute Maximum Ratings

over operating junction temperature range (unless otherwise noted); all voltages are with respect to GND⁽¹⁾

		MIN	MAX	UNIT
Voltage	V _{IN}	-0.3	6	V
	V _{EN}	-0.3	V _{IN} + 0.3	
	V _{OUT}	-0.3	3.6	
Current	I _{OUT}	Internally limited		A
Output short-circuit duration		Indefinite		
Temperature	Operating junction, T _J	-40	150	°C
	Storage, T _{stg}	-65	160	

(1) Stresses beyond those listed under *Absolute Maximum Ratings* may cause permanent damage to the device. These are stress ratings only, which do not imply functional operation of the device at these or any other conditions beyond those indicated under *Recommended Operating Conditions*. Exposure to absolute-maximum-rated conditions for extended periods may affect device reliability.

6.2 ESD Ratings

			VALUE	UNIT
V _(ESD)	Electrostatic discharge	Human-body model (HBM), per ANSI/ESDA/JEDEC JS-001 ⁽¹⁾	±2000	V
		Charged-device model (CDM), per JEDEC specification JESD22-C101 ⁽²⁾	±500	

(1) JEDEC document JEP155 states that 500-V HBM allows safe manufacturing with a standard ESD control process.

(2) JEDEC document JEP157 states that 250-V CDM allows safe manufacturing with a standard ESD control process.

6.3 Recommended Operating Conditions

over operating free-air temperature range (unless otherwise noted)

		MIN	NOM	MAX	UNIT
V _{IN}	Input range	1.4		5.5	V
V _{OUT}	Output range	1		3.3	V
I _{OUT}	Output current	0		300	mA
V _{EN}	Enable range	0		V _{IN}	V
T _J	Junction temperature	-40		125	°C

6.4 Thermal Information

THERMAL METRIC ⁽¹⁾		TLV743P		UNIT
		DBV (SOT-23)	DQN (X2SON)	
		5 PINS	4 PINS	
R _{θJA}	Junction-to-ambient thermal resistance	228.4	218.6	°C/W
R _{θJC(top)}	Junction-to-case (top) thermal resistance	151.5	164.8	°C/W
R _{θJB}	Junction-to-board thermal resistance	55.8	164.9	°C/W
ψ _{JT}	Junction-to-top characterization parameter	31.4	5.6	°C/W
ψ _{JB}	Junction-to-board characterization parameter	54.8	163.9	°C/W
R _{θJC(bot)}	Junction-to-case (bottom) thermal resistance	N/A	131.4	°C/W

(1) For more information about traditional and new thermal metrics, see the [Semiconductor and IC Package Thermal Metrics](#) application report.

6.5 Electrical Characteristics

at operating temperature range ($T_J = -40^\circ\text{C}$ to $+125^\circ\text{C}$), $V_{IN} = V_{OUT(nom)} + 0.5\text{ V}$ or 2 V (whichever is greater), $I_{OUT} = 1\text{ mA}$, $V_{EN} = V_{IN}$, and $C_{IN} = C_{OUT} = 1\text{ }\mu\text{F}$ (unless otherwise noted). All typical values at $T_J = 25^\circ\text{C}$.

PARAMETER		TEST CONDITIONS		MIN	TYP	MAX	UNIT
V_{IN}	Input voltage			1.4		5.5	V
	DC output accuracy	$T_J = 25^\circ\text{C}$		-1%		1%	
		$-40^\circ\text{C} \leq T_J \leq 125^\circ\text{C}$		-1.4%		1.4%	
UVLO	Undervoltage lockout	V_{IN} rising			1.3	1.4	V
		V_{IN} falling			1.25		
$\Delta V_{O(\Delta V)}$	Line regulation	$\Delta V_I = V_{IN(nom)}$ to $V_{IN(nom)} + 1$			1		mV
$\Delta V_{O(\Delta I)}$	Load regulation	$\Delta I_O = 1\text{ mA}$ to 300 mA	DBV package		16		mV
					25		
V_{DO}	Dropout voltage ⁽¹⁾	$V_{OUT} = 0.98 \times V_{OUT(nom)}$ $I_{OUT} = 300\text{ mA}$	$V_{OUT} = 1.1\text{ V}$ $-40^\circ\text{C} \leq T_J \leq 85^\circ\text{C}$			480	mV
			$1.2\text{ V} \leq V_{OUT} < 1.5\text{ V}$ $-40^\circ\text{C} \leq T_J \leq 85^\circ\text{C}$			420	
			$1.5\text{ V} \leq V_{OUT} < 1.8\text{ V}$ $-40^\circ\text{C} \leq T_J \leq 85^\circ\text{C}$			370	
			$1.8\text{ V} \leq V_{OUT} < 2.5\text{ V}$ $-40^\circ\text{C} \leq T_J \leq 85^\circ\text{C}$			270	
			$2.5\text{ V} \leq V_{OUT} < 3.3\text{ V}$ $-40^\circ\text{C} \leq T_J \leq 85^\circ\text{C}$			260	
			$V_{OUT} = 3.3\text{ V}$ $-40^\circ\text{C} \leq T_J \leq 85^\circ\text{C}$	125	220		
			$1.2\text{ V} \leq V_{OUT} < 1.5\text{ V}$ $-40^\circ\text{C} \leq T_J \leq 125^\circ\text{C}$		450		
			$1.5\text{ V} \leq V_{OUT} < 1.8\text{ V}$ $-40^\circ\text{C} \leq T_J \leq 125^\circ\text{C}$		400		
			$1.8\text{ V} \leq V_{OUT} < 2.5\text{ V}$ $-40^\circ\text{C} \leq T_J \leq 125^\circ\text{C}$		300		
			$2.5\text{ V} \leq V_{OUT} < 3.3\text{ V}$ $-40^\circ\text{C} \leq T_J \leq 125^\circ\text{C}$		290		
			$V_{OUT} = 3.3\text{ V}$ $-40^\circ\text{C} \leq T_J \leq 125^\circ\text{C}$	125	270		
I_{GND}	Ground pin current	$I_{OUT} = 0\text{ mA}$			34	60	μA
I_{SHDN}	Shutdown current	$V_{EN} \leq 0.35\text{ V}$ $2\text{ V} \leq V_{IN} \leq 5.5\text{ V}$ $T_J = 25^\circ\text{C}$			0.1	1	μA
PSRR	Power-supply rejection ratio	$V_{OUT} = 1.8\text{ V}$ $I_{OUT} = 300\text{ mA}$	$f = 100\text{ Hz}$		68		dB
			$f = 10\text{ kHz}$		35		
			$f = 100\text{ kHz}$		28		
V_n	Output noise voltage	Bandwidth = 10 Hz to 100 kHz $V_{OUT} = 1.8\text{ V}$ $I_{OUT} = 10\text{ mA}$			120		μV_{RMS}
$V_{EN(HI)}$	EN pin high voltage (enabled)			0.9			V
$V_{EN(LO)}$	EN pin low voltage (disabled)					0.35	V
I_{EN}	EN pin current	$V_{EN} = 5.5\text{ V}$			0.01		μA

(1) Dropout voltage for the TLV743P is not valid at room temperature. The device engages undervoltage lockout ($V_{IN} < UVLO_{FALL}$) before the dropout condition is met.

Electrical Characteristics (continued)

at operating temperature range ($T_J = -40^{\circ}\text{C}$ to $+125^{\circ}\text{C}$), $V_{IN} = V_{OUT}(\text{nom}) + 0.5\text{ V}$ or 2 V (whichever is greater), $I_{OUT} = 1\text{ mA}$, $V_{EN} = V_{IN}$, and $C_{IN} = C_{OUT} = 1\text{ }\mu\text{F}$ (unless otherwise noted). All typical values at $T_J = 25^{\circ}\text{C}$.

PARAMETER		TEST CONDITIONS	MIN	TYP	MAX	UNIT
t_{STR}	Startup time	Time from EN assertion to $98\% \times V_{OUT}(\text{nom})$ $V_{OUT} = 1\text{ V}$ $I_{OUT} = 0\text{ mA}$		250		μs
		Time from EN assertion to $98\% \times V_{OUT}(\text{nom})$ $V_{OUT} = 3.3\text{ V}$ $I_{OUT} = 0\text{ mA}$		800		
	Pulldown resistor	$V_{IN} = 2.3\text{ V}$		120		Ω
I_{LIM}	Output current limit		360		700	mA
I_{OS}	Short-circuit current limit	V_{OUT} shorted to GND $V_{OUT} = 1\text{ V}$		150		mA
		V_{OUT} shorted to GND $V_{OUT} = 3.3\text{ V}$		170		
T_{sd}	Thermal shutdown	Shutdown, temperature increasing		160		$^{\circ}\text{C}$
		Reset, temperature decreasing		140		

6.6 Typical Characteristics

at operating temperature range ($T_J = -40^\circ\text{C}$ to $+125^\circ\text{C}$), $V_{IN} = V_{OUT(nom)} + 0.5\text{ V}$ or 2 V (whichever is greater), $I_{OUT} = 1\text{ mA}$, $V_{EN} = V_{IN}$, and $C_{IN} = C_{OUT} = 1\text{ }\mu\text{F}$ (unless otherwise noted)

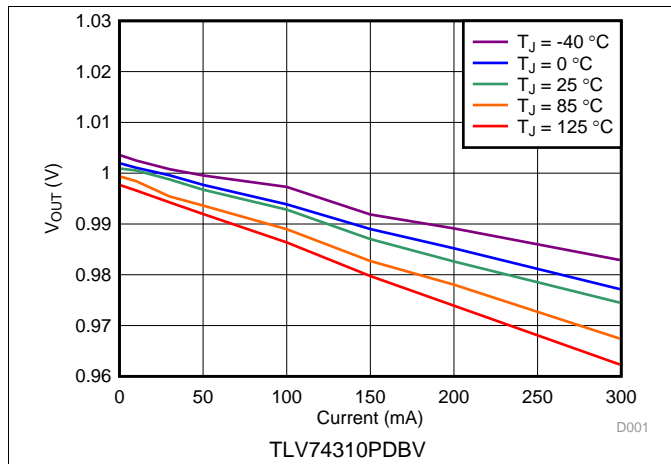

Figure 1. 1-V Load Regulation vs I_{OUT} and Temperature

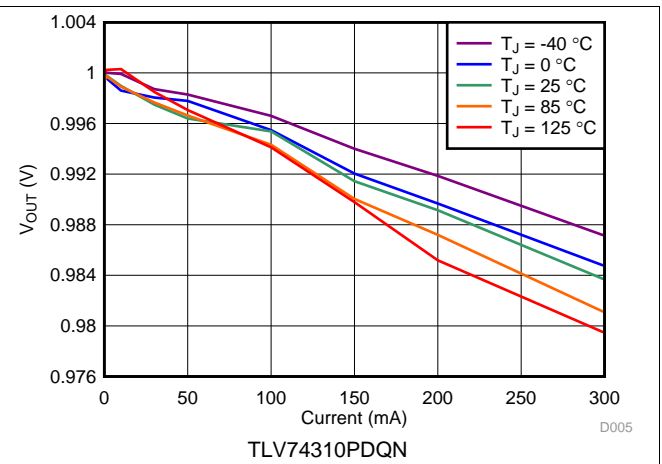

Figure 2. 1-V Load Regulation vs I_{OUT} and Temperature

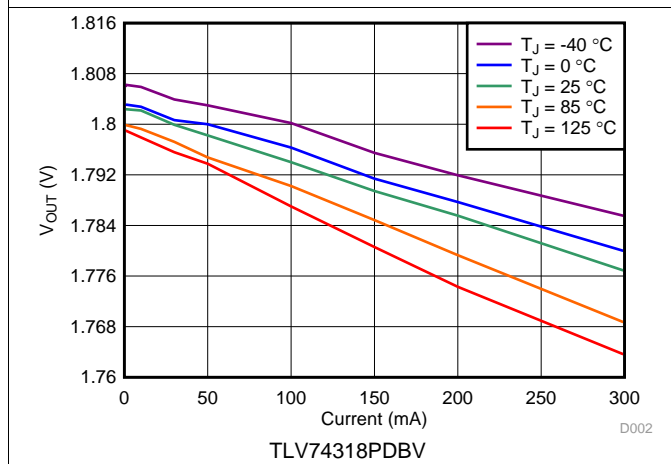

Figure 3. 1.8-V Load Regulation vs I_{OUT} and Temperature

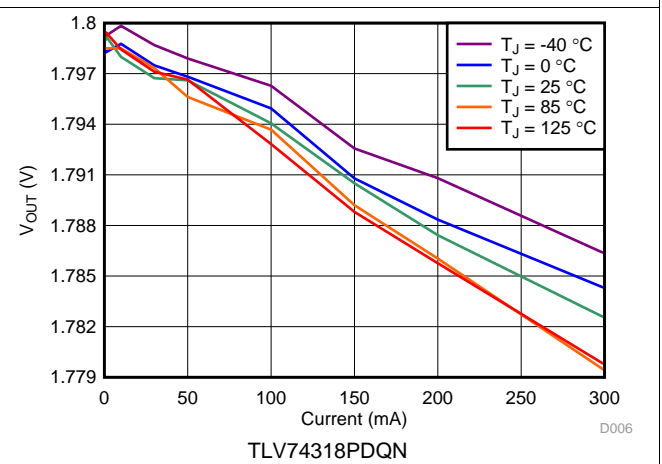

Figure 4. 1.8-V Load Regulation vs I_{OUT} and Temperature

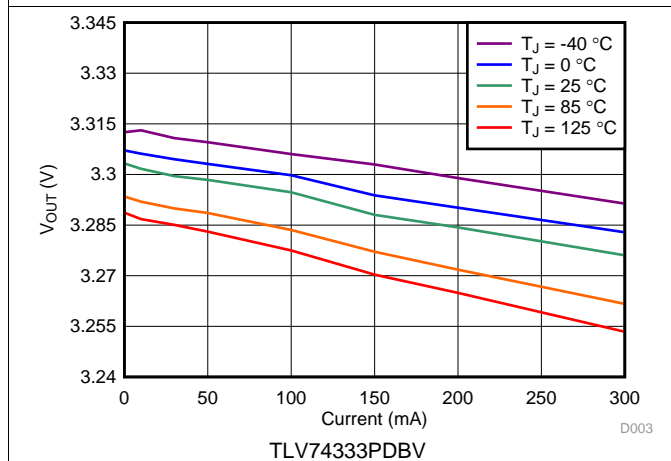

Figure 5. 3.3-V Load Regulation vs I_{OUT} and Temperature

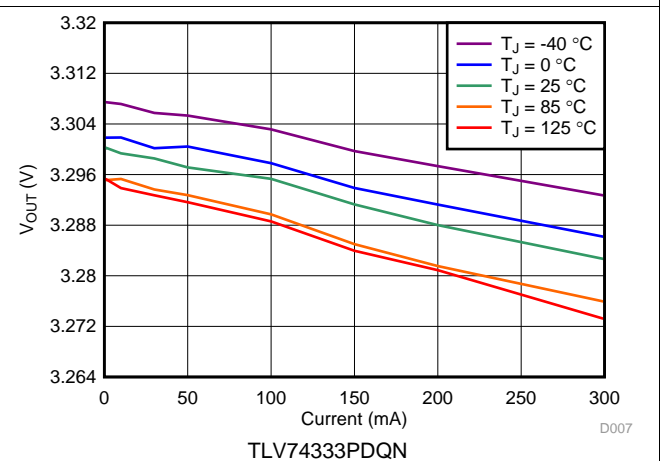

Figure 6. 3.3-V Load Regulation vs I_{OUT} and Temperature

Typical Characteristics (continued)

at operating temperature range ($T_J = -40^{\circ}\text{C}$ to $+125^{\circ}\text{C}$), $V_{IN} = V_{OUT}(\text{nom}) + 0.5\text{ V}$ or 2 V (whichever is greater), $I_{OUT} = 1\text{ mA}$, $V_{EN} = V_{IN}$, and $C_{IN} = C_{OUT} = 1\ \mu\text{F}$ (unless otherwise noted)

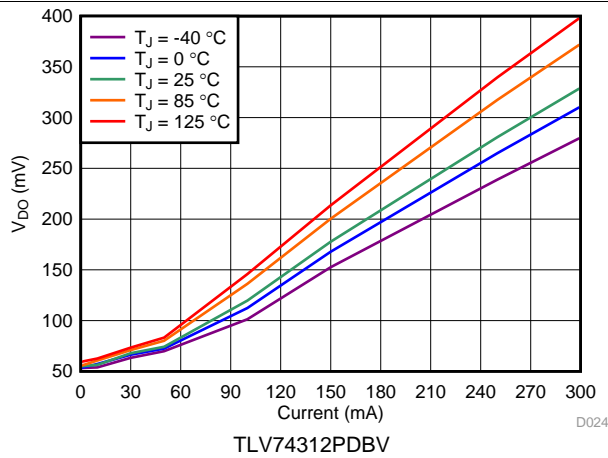

Figure 7. 1.2-V Dropout Voltage vs I_{OUT} and Temperature

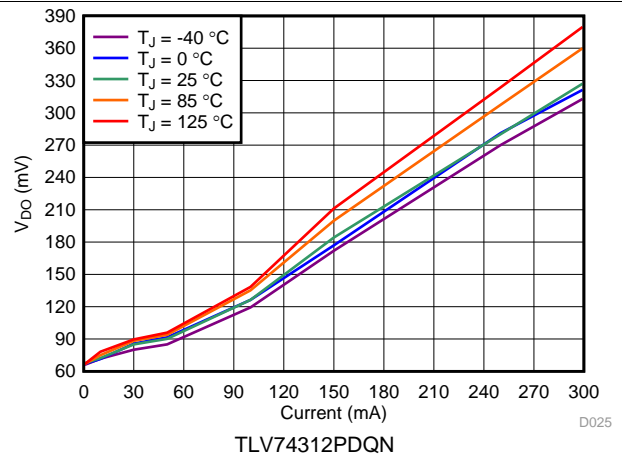

Figure 8. 1.2-V Dropout Voltage vs I_{OUT} and Temperature

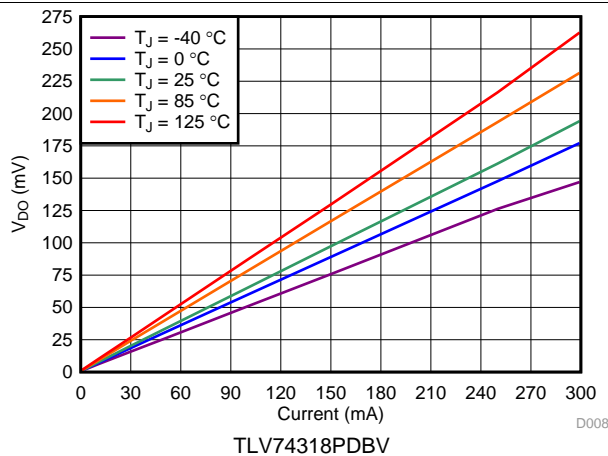

Figure 9. 1.8-V Dropout Voltage vs I_{OUT} and Temperature

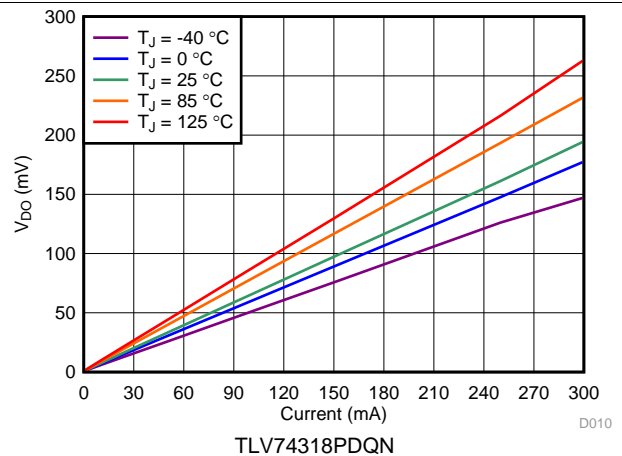

Figure 10. 1.8-V Dropout Voltage vs I_{OUT} and Temperature

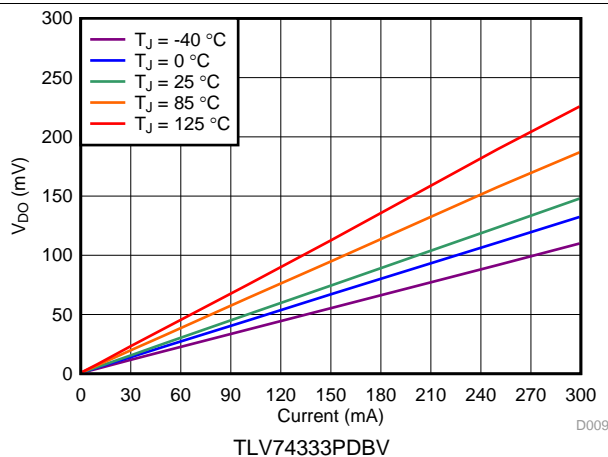

Figure 11. 3.3-V Dropout Voltage vs I_{OUT} and Temperature

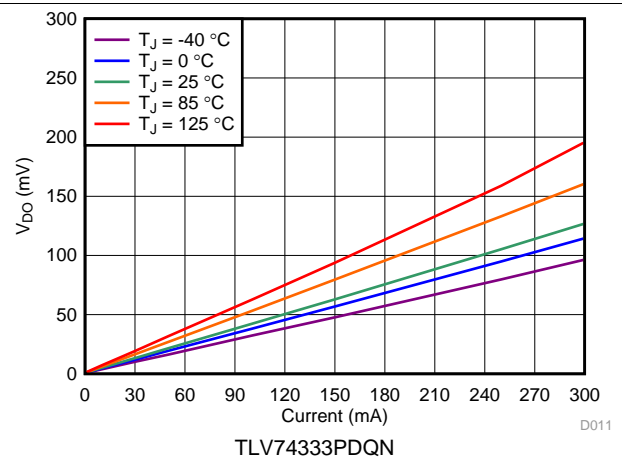

Figure 12. 3.3-V Dropout Voltage vs I_{OUT} and Temperature

Typical Characteristics (continued)

at operating temperature range ($T_J = -40^{\circ}\text{C}$ to $+125^{\circ}\text{C}$), $V_{IN} = V_{OUT(nom)} + 0.5\text{ V}$ or 2 V (whichever is greater), $I_{OUT} = 1\text{ mA}$, $V_{EN} = V_{IN}$, and $C_{IN} = C_{OUT} = 1\text{ }\mu\text{F}$ (unless otherwise noted)

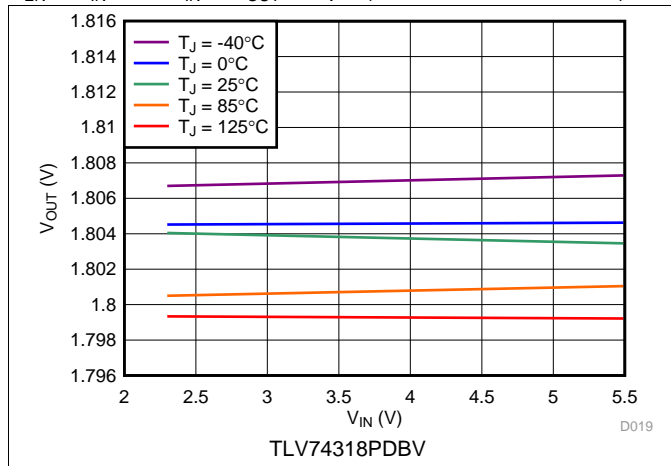

Figure 13. 1.8-V Regulation vs V_{IN} (Line Regulation) and Temperature

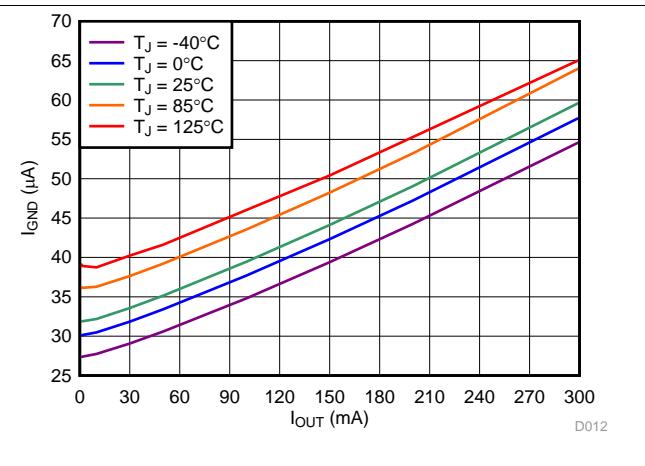

Figure 14. Ground Pin Current vs I_{OUT} and Temperature

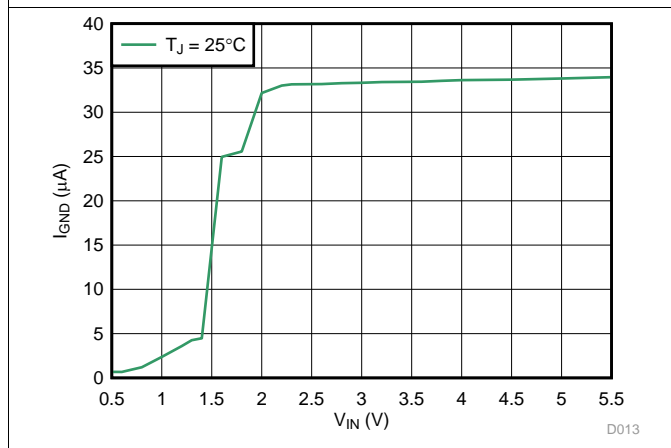

Figure 15. Ground Pin Current vs V_{IN}

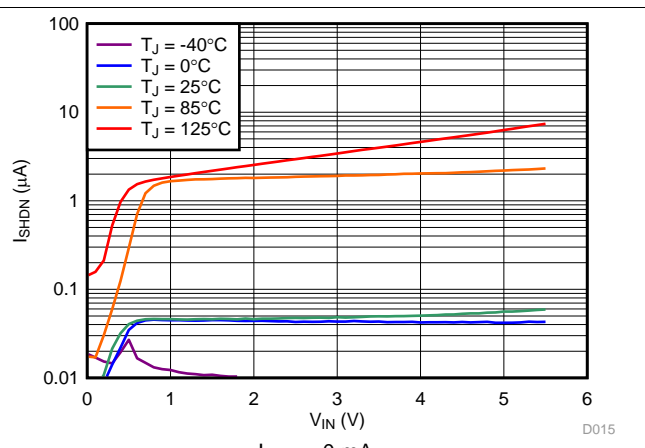

Figure 16. Shutdown Current vs V_{IN} and Temperature

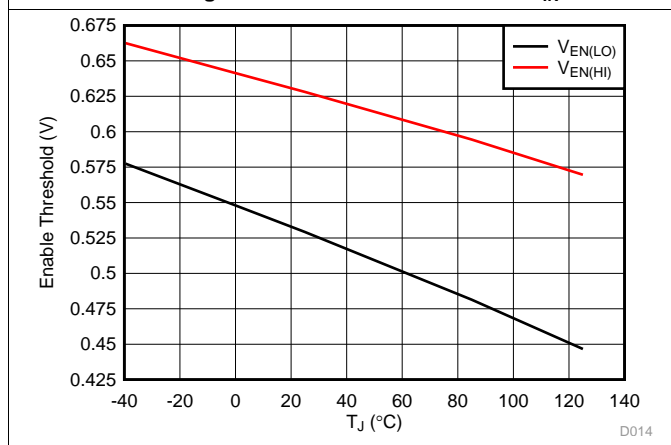

Figure 17. Enable Threshold vs Temperature

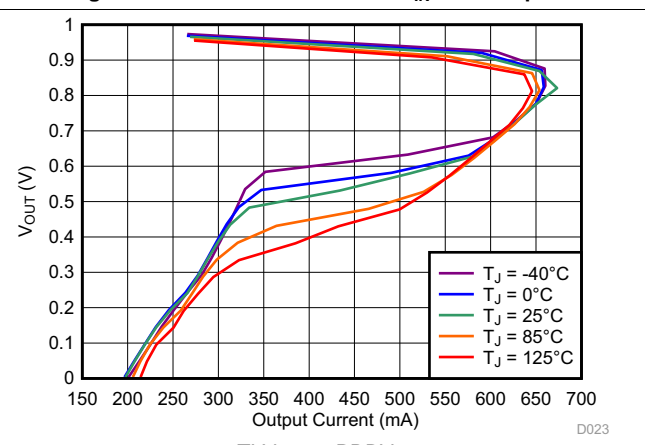

Figure 18. 1-V Foldback Current Limit vs I_{OUT} and Temperature

Typical Characteristics (continued)

at operating temperature range ($T_J = -40^{\circ}\text{C}$ to $+125^{\circ}\text{C}$), $V_{IN} = V_{OUT}(\text{nom}) + 0.5\text{ V}$ or 2 V (whichever is greater), $I_{OUT} = 1\text{ mA}$, $V_{EN} = V_{IN}$, and $C_{IN} = C_{OUT} = 1\ \mu\text{F}$ (unless otherwise noted)

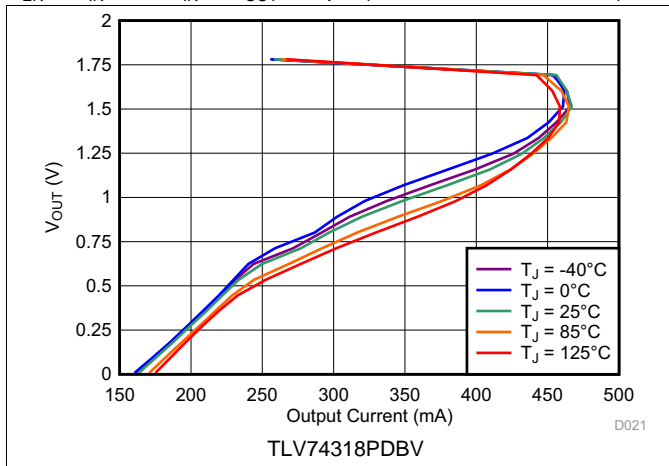

Figure 19. 1.8-V Foldback Current Limit vs I_{OUT} and Temperature

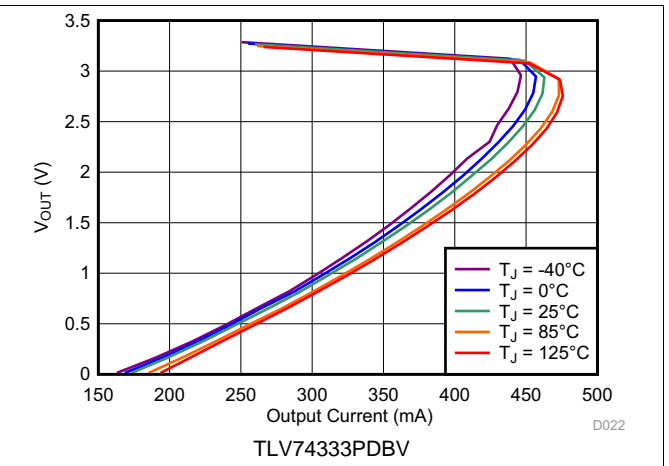

Figure 20. 3.3-V Foldback Current Limit vs I_{OUT} and Temperature

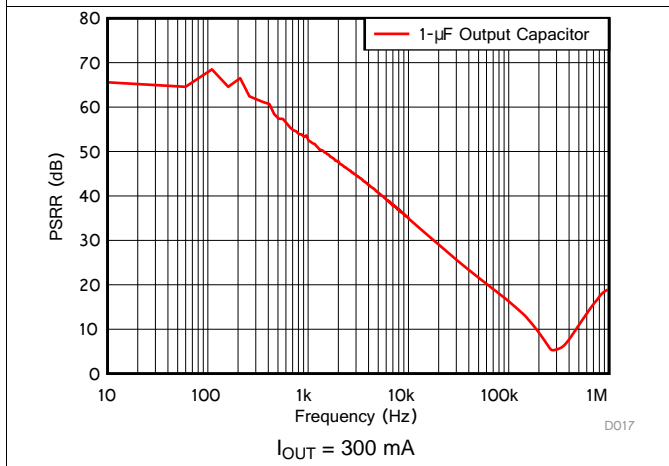

Figure 21. Power-Supply Rejection Ratio vs Frequency

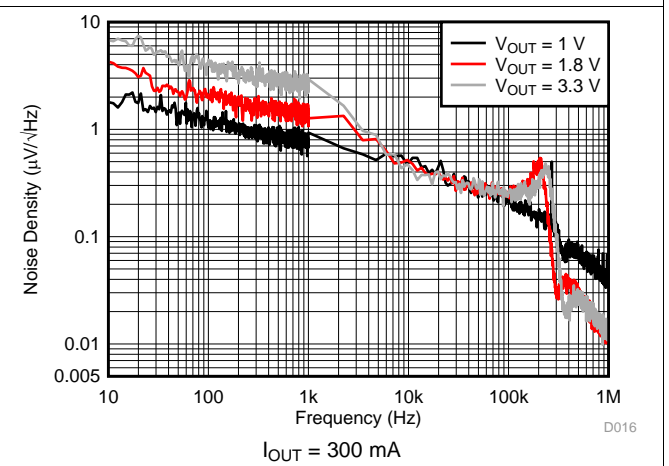

Figure 22. Output Spectral Noise Density

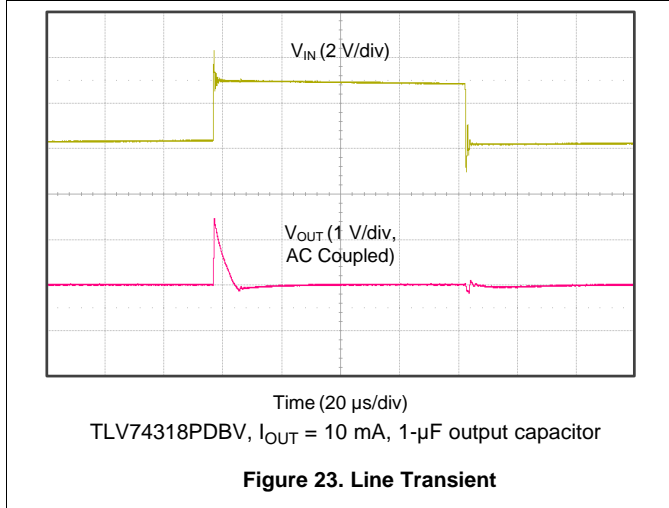

Figure 23. Line Transient

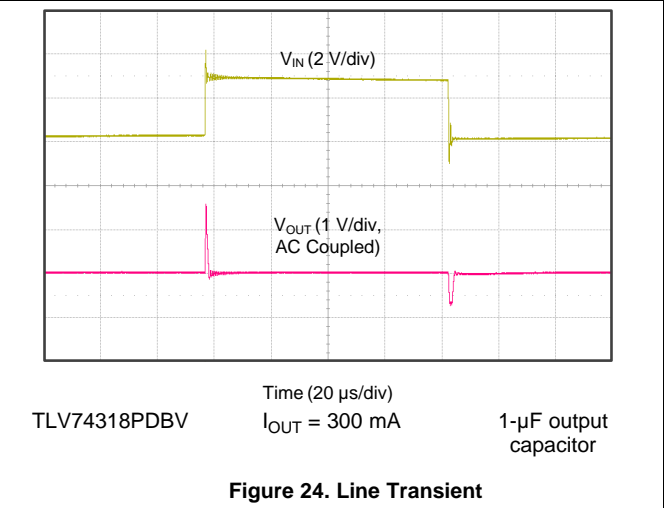
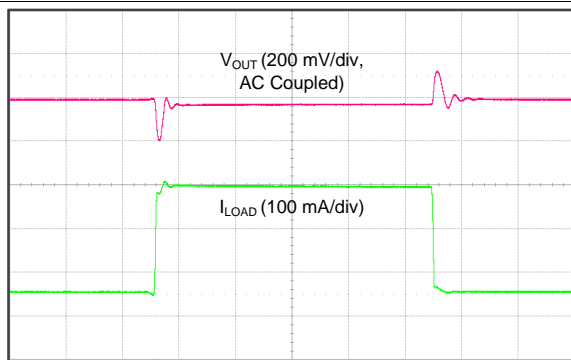

Figure 24. Line Transient

Typical Characteristics (continued)

at operating temperature range ($T_J = -40^{\circ}\text{C}$ to $+125^{\circ}\text{C}$), $V_{IN} = V_{OUT}(\text{nom}) + 0.5\text{ V}$ or 2 V (whichever is greater), $I_{OUT} = 1\text{ mA}$, $V_{EN} = V_{IN}$, and $C_{IN} = C_{OUT} = 1\text{ }\mu\text{F}$ (unless otherwise noted)



Time (20 $\mu\text{s}/\text{div}$)
 TLV74310 $V_{IN} = 2\text{ V}$, $1\text{-}\mu\text{F}$ output capacitor,
 PDBV output current slew rate = $0.25\text{ A}/\mu\text{s}$

Figure 25. 1-V, 50-mA to 300-mA Load Transient

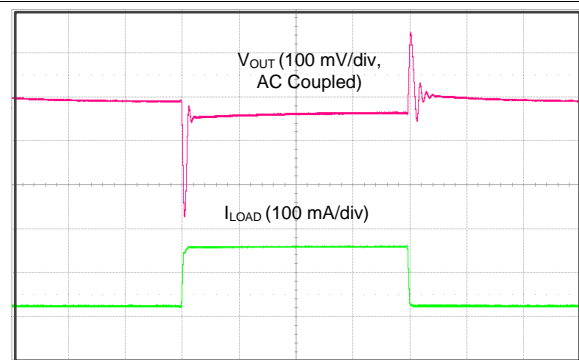

Time (20 $\mu\text{s}/\text{div}$)
 TLV74333PDBV, $V_{IN} = 3.8\text{ V}$, $1\text{-}\mu\text{F}$ output capacitor, output current
 slew rate = $0.25\text{ A}/\mu\text{s}$

Figure 26. 3.3 V, 50-mA to 300-mA Load Transient

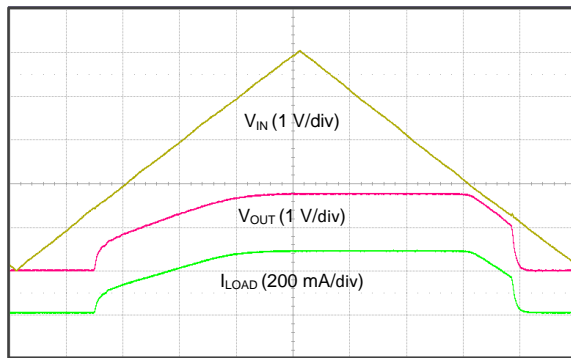

Time (100 $\mu\text{s}/\text{div}$)
 TLV74318PDBV, $R_L = 6.2\text{ }\Omega$, $V_{EN} = V_{IN}$, $1\text{-}\mu\text{F}$ output capacitor

Figure 27. V_{IN} Power-Up and Power-Down

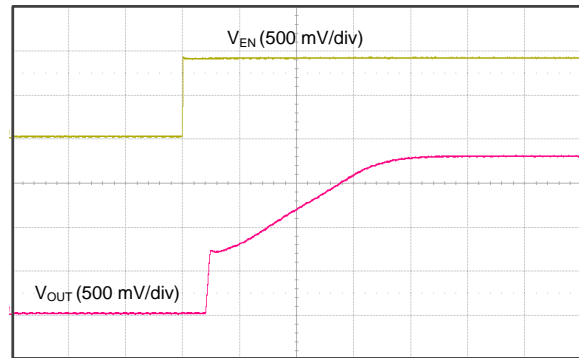

Time (100 $\mu\text{s}/\text{div}$)
 TLV74318PDBV, $R_L = 6.2\text{ }\Omega$, $1\text{-}\mu\text{F}$ output capacitor

Figure 28. Startup with EN

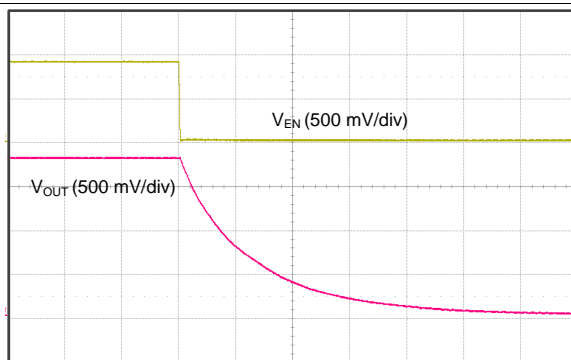

Time (100 $\mu\text{s}/\text{div}$)
 TLV74318PDBV, $I_{OUT} = 300\text{ mA}$, $1\text{-}\mu\text{F}$ output capacitor

Figure 29. Shutdown Response With Enable

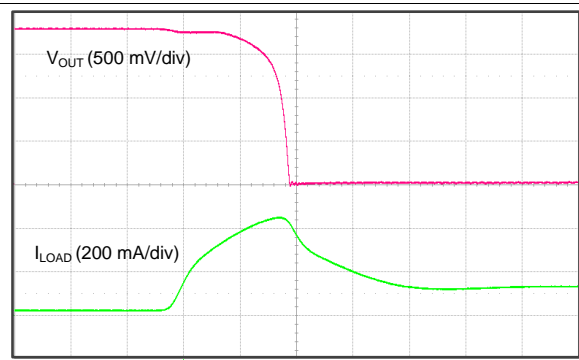

Time (100 $\mu\text{s}/\text{div}$)
 TLV74318PDBV, $1\text{-}\mu\text{F}$ output capacitor

Figure 30. Foldback Current Limit Response

7 Detailed Description

7.1 Overview

The TLV743P device belongs to a new family of next-generation, low-dropout regulators (LDOs). This device consumes low quiescent current and delivers excellent line and load transient performance. These characteristics, combined with low noise, good PSRR with low-dropout voltage, make this device well-suited for portable consumer applications.

This regulator offers foldback current limit, shutdown, and thermal protection. The operating junction temperature for this device is -40°C to $+125^{\circ}\text{C}$.

7.2 Functional Block Diagram

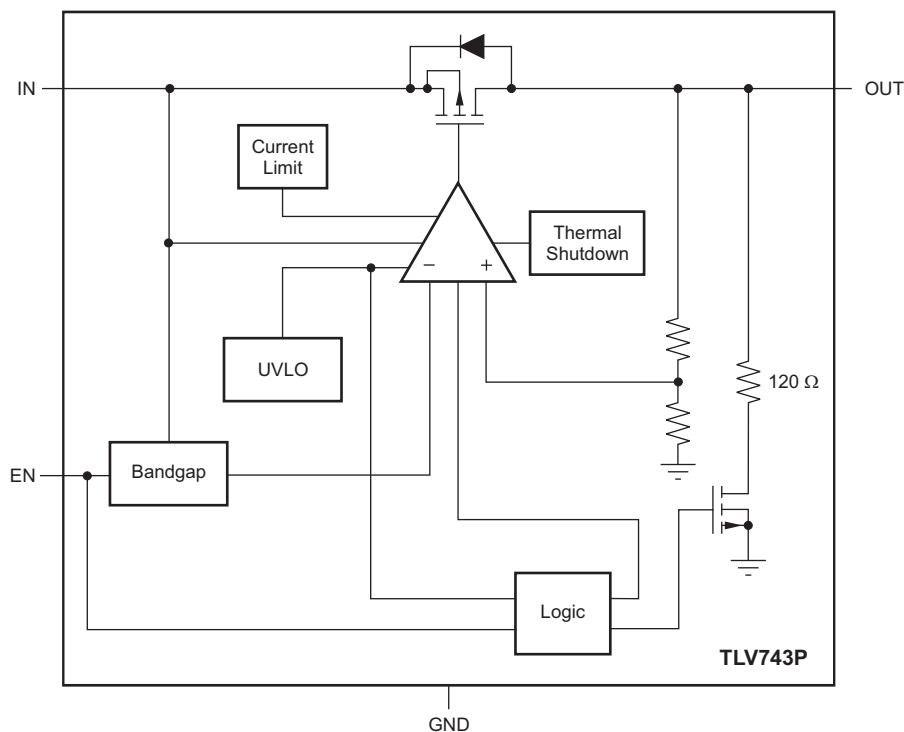

7.3 Feature Description

7.3.1 Undervoltage Lockout (UVLO)

The TLV743P device uses an undervoltage lockout (UVLO) circuit that disables the output until the input voltage is greater than the rising UVLO voltage, $UVLO_{RISE}$. This circuit makes certain that the device does not exhibit any unpredictable behavior when the supply voltage is lower than the operational range of the internal circuitry. During UVLO disable, the output connects to ground with a 120- Ω pulldown resistor.

7.3.2 Shutdown and Output Enable

The enable pin (EN) is active high. Enable the device by forcing the EN pin to exceed $V_{EN(HI)}$. Turn off the device by forcing the EN pin to drop below $V_{EN(LO)}$. If shutdown capability is not required, connect EN to IN. There is no internal pulldown resistor connected to the EN pin.

The TLV743P device has an internal pulldown MOSFET that connects a 120- Ω resistor to ground when the device is disabled. The discharge time after disabling depends on the output capacitance (C_{OUT}) and the load resistance (R_L) in parallel with the 120- Ω pulldown resistor. The time constant is calculated in [Equation 1](#):

$$t = \frac{120 \times R_L}{120 + R_L} \times C_{OUT} \quad (1)$$

7.3.3 Internal Foldback Current Limit

The TLV743P device has an internal foldback current limit that protects the regulator during fault conditions. The current allowed through the device is reduced as the output voltage falls. When the output is shorted, the LDO supplies a typical current of 150 mA. The output voltage is not regulated when the device is in current limit. In this condition, the output voltage is the product of the regulated current and the load resistance. When the device output is shorted, the PMOS pass transistor dissipates power $[(V_{IN} - V_{OUT}) \times I_{OS}]$ until thermal shutdown is triggered and the device turns off. After the device cools down, the internal thermal shutdown circuit turns the device back on. If the fault condition continues, the device cycles between current limit and thermal shutdown. See [Thermal Information](#) for more details.

The foldback current limit circuit limits the current allowed through the device to current levels lower than the minimum current limit at nominal V_{OUT} current limit (I_{LIM}) during startup. See [Figure 18](#) to [Figure 20](#) for typical foldback current limit values. If the output is loaded by a constant-current load during startup, or if the output voltage is negative when the device is enabled, then the required load current by the load may exceed the foldback current limit and the device may not rise to the full output voltage. For constant current loads, disable the output load until the TLV743P has risen to the nominal output voltage.

The TLV743P PMOS pass element has an intrinsic body diode that conducts current when the voltage at the OUT pin exceeds the voltage at the IN pin. Do not force the output voltage to exceed the input voltage because excessively high current may flow through the body diode.

7.3.4 Thermal Shutdown

Thermal shutdown protection disables the output when the junction temperature rises to approximately 160°C. Disabling the device eliminates power dissipated by the device, which allows the device to cool. When the junction temperature cools to approximately 140°C, the output circuitry is enabled again. Depending on power dissipation, thermal resistance, and ambient temperature, the thermal protection circuit may cycle on and off. This cycling limits regulator dissipation, which protects the device from damage as a result of overheating.

Activating the thermal shutdown feature usually indicates excessive power dissipation as a result of the product of the $(V_{IN} - V_{OUT})$ voltage and the load current. For reliable operation, limit junction temperature to 125°C maximum. To estimate the margin of safety in a complete design, increase the ambient temperature until the thermal protection is triggered; use worst-case loads and signal conditions.

The TLV743P internal protection circuitry protects against overload conditions, but is not intended to be active in normal operation. Continuously running the TLV743P device into thermal shutdown degrades device reliability.

7.4 Device Functional Modes

7.4.1 Normal Operation

The device regulates to the nominal output voltage under the following conditions:

- The input voltage has previously exceeded the UVLO rising voltage and has not decreased below the UVLO falling threshold.
- The input voltage is greater than the nominal output voltage added to the dropout voltage.
- The enable voltage has previously exceeded the enable rising threshold voltage and not decreased below the enable falling threshold.
- The output current is less than the current limit.
- The device junction temperature is less than the thermal shutdown temperature.

7.4.2 Dropout Operation

If the input voltage is lower than the nominal output voltage plus the specified dropout voltage, but all other conditions are met for normal operation, the device operates in dropout mode. In this condition, the output voltage is the same the input voltage minus the dropout voltage. The transient performance of the device is significantly degraded because the pass device is in a triode state and no longer controls the current through the LDO. Line or load transients in dropout may result in large output voltage deviations.

7.4.3 Disabled

The device is disabled under the following conditions:

- The input voltage is less than the UVLO falling voltage, or has not yet exceeded the UVLO rising threshold.
- The enable voltage is less than the enable falling threshold voltage or has not yet exceeded the enable rising threshold.
- The device junction temperature is greater than the thermal shutdown temperature.

When the device is disabled, the active pulldown resistor discharges the output.

[Table 1](#) lists the conditions that result in different operating modes.

Table 1. Device Functional Mode Comparison

OPERATING MODE	PARAMETER			
	V_{IN}	V_{EN}	I_{OUT}	T_J
Normal mode	$V_{IN} > V_{OUT(nom)} + V_{DO}$ and $V_{IN} > UVLO_{RISE}$	$V_{EN} > V_{EN(HI)}$	$I_{OUT} < I_{LIM}$	$T_J < 160^{\circ}C$
Dropout mode	$UVLO_{RISE} < V_{IN} < V_{OUT(nom)} + V_{DO}$	$V_{EN} > V_{EN(HI)}$	$I_{OUT} < I_{LIM}$	$T_J < 160^{\circ}C$
Disabled mode (any true condition disables the device)	$V_{IN} < UVLO_{FALL}$	$V_{EN} < V_{EN(LO)}$	—	$T_J > 160^{\circ}C$

8 Application and Implementation

NOTE

Information in the following applications sections is not part of the TI component specification, and TI does not warrant its accuracy or completeness. TI's customers are responsible for determining suitability of components for their purposes. Customers should validate and test their design implementation to confirm system functionality.

8.1 Application Information

8.1.1 Input and Output Capacitor Selection

The TLV743P device uses an advanced internal control loop to obtain stable operation with the use of input or output capacitors. An output capacitance of 1 μF or larger generally provides good dynamic response. Use X5R- and X7R-type ceramic capacitors because these capacitors have minimal variation in value and equivalent series resistance (ESR) over temperature.

Although an input capacitor is not required for stability, increased output impedance from the input supply may compromise the performance of the TLV743P. Good analog design practice is to connect a 0.1- μF to 1- μF capacitor from IN to GND. This capacitor counteracts reactive input sources and improves transient response, input ripple, and PSRR. Use an input capacitor if the source impedance is greater than 0.5 Ω . Use a higher-value capacitor if large, fast, rise-time load transients are expected, or if the device is located several inches from the input power source.

8.1.2 Dropout Voltage

The TLV743P device uses a PMOS pass transistor to achieve low dropout. When $(V_{\text{IN}} - V_{\text{OUT}})$ is less than the dropout voltage (V_{DO}), the PMOS pass device is in the linear region of operation and the input-to-output resistance is the $R_{\text{DS(ON)}}$ of the PMOS pass element. V_{DO} scales approximately with output current because the PMOS device behaves like a resistor in dropout mode. As with any linear regulator, PSRR and transient response degrade as $(V_{\text{IN}} - V_{\text{OUT}})$ approaches dropout operation. See [Figure 7](#) to [Figure 12](#) for typical dropout values.

Application Information (continued)

8.1.3 Power Dissipation

The ability to remove heat from the die is different for each package type and presents different considerations in the printed circuit board (PCB) layout. The PCB area around the device that is free of other components moves the heat from the device to ambient air. Performance data for JEDEC high-K boards are shown in [Thermal Information](#). Using heavier copper increases the effectiveness in removing heat from the device. The addition of plated through-holes to heat-dissipating layers also improves heat sink effectiveness.

Power dissipation (P_D) depends on input voltage and load conditions. P_D is equal to the product of the output current and voltage drop across the output pass element, as shown in [Equation 2](#).

$$P_D = (V_{IN} - V_{OUT}) \times I_{OUT} \quad (2)$$

[Figure 31](#) shows the maximum ambient temperature versus the power dissipation of the TLV743P device in the DQN and DBV packages. This figure assumes the device is soldered on JEDEC standard high-K layout with no airflow over the board. Actual board thermal impedances vary widely. If the application requires high power dissipation, it is helpful to have a thorough understanding of the board temperature and thermal impedances to make certain that the TLV743P device does not operate continuously above a junction temperature of 125°C.

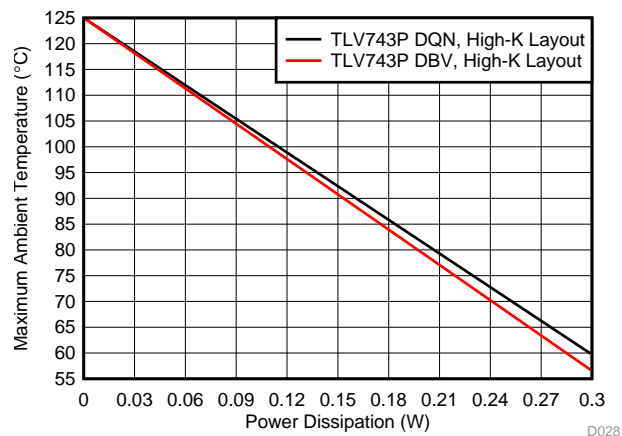

TLV743P, high-K layout

Figure 31. Maximum Ambient Temperature vs Device Power Dissipation

8.2 Typical Application



Figure 32. DC/DC Converter Post Regulation

8.2.1 Design Requirements

Table 2. Design Parameters

PARAMETER	DESIGN REQUIREMENT
Input voltage	1.8 V, $\pm 5\%$
Output voltage	1.5 V, $\pm 1\%$
Output current	200-mA DC, 300-mA peak
Output voltage transient deviation	< 10%, 1-A/ μ s load step from 50 mA to 200 mA
Maximum ambient temperature	85°C

8.2.2 Detailed Design Procedure

Input and output capacitors are required to achieve the output voltage transient requirements. Capacitance values of 1 μ F are selected to give the maximum output capacitance in a small, low-cost package.

Figure 7 shows the 1.2-V option dropout voltage. Given that dropout voltages are higher for lower output-voltage options, and given that the 1.2-V option dropout voltage is typically less than 300 mV at 125°C, then the 1.5-V option dropout voltage is typically less than 300 mV at 125°C.

See Figure 31 to verify that the maximum junction temperature is not exceeded.

8.2.3 Application Curve

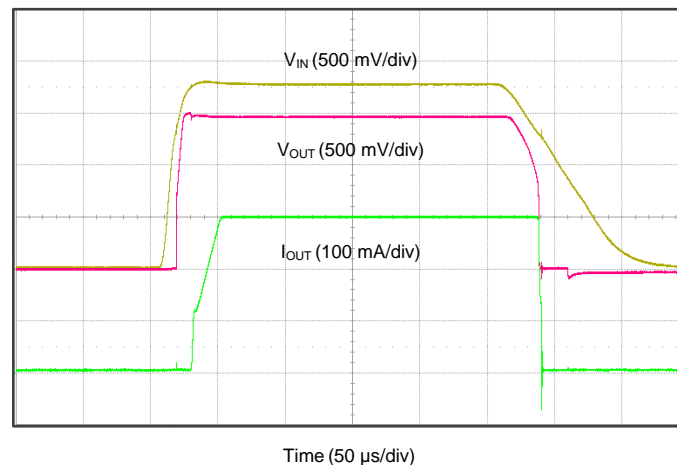

Figure 33. 1.8-V to 1.5-V Regulation at 300 mA

9 Power Supply Recommendations

Connect a low-output impedance power supply directly to the IN pin of the TLV743P device. Inductive impedances between the input supply and the IN pin can create significant voltage excursions at the IN pin during startup or load transient events. If inductive impedances are unavoidable, use an input capacitor.

10 Layout

10.1 Layout Guidelines

- Place input and output capacitors as close as possible to the device.
- Use copper planes for device connections to optimize thermal performance.
- Place thermal vias around the device to distribute heat.

10.2 Layout Examples



Figure 34. Layout Example: DBV Package



(1) Not required.

Figure 35. X2SON Layout Example

11 Device and Documentation Support

11.1 Device Support

11.1.1 Development Support

11.1.1.1 Evaluation Module

An evaluation module (EVM) is available to assist in the initial circuit performance evaluation using the TLV743P device. The [TLV73312PEVM-643 evaluation module](#) (and [related user guide](#)) can be requested at the Texas Instruments website through the product folders or purchased directly from the [TI eStore](#).

11.1.2 Device Nomenclature

Table 3. Device Nomenclature⁽¹⁾⁽²⁾

PRODUCT	V _{OUT}
TLV743Pxx(x)Pyyyz(3)	<p>xx(x) is the nominal output voltage. For output voltages with a resolution of 100 mV, two digits are used in the ordering number; otherwise, three digits are used (for example, 28 = 2.8 V; 125 = 1.25 V).</p> <p>P indicates an active output discharge feature. All members of the TLV743 family will actively discharge the output when the device is disabled.</p> <p>yyy is the package designator.</p> <p>z is the package quantity. R is for reel (3000 pieces), T is for tape (250 pieces).</p> <p>(3) indicates an alternative tape and reel orientation. 3 indicates that pin 1 is in quadrant 3. See the <i>Package Materials Information</i> addendum for more information.</p>

- (1) For the most current package and ordering information see the Package Option Addendum at the end of this document, or visit the device product folder on www.ti.com.
- (2) Output voltages from 1 V to 3.3 V in 50-mV increments are available. Contact the factory for details and availability.

11.2 Documentation Support

11.2.1 Related Documentation

[TLV73312PDQN-643 Evaluation Module User Guide](#) (SBVU024)

11.3 Receiving Notification of Documentation Updates

To receive notification of documentation updates, navigate to the device product folder on ti.com. In the upper right corner, click on *Alert me* to register and receive a weekly digest of any product information that has changed. For change details, review the revision history included in any revised document.

11.4 Community Resources

The following links connect to TI community resources. Linked contents are provided "AS IS" by the respective contributors. They do not constitute TI specifications and do not necessarily reflect TI's views; see TI's [Terms of Use](#).

TI E2E™ Online Community *TI's Engineer-to-Engineer (E2E) Community*. Created to foster collaboration among engineers. At e2e.ti.com, you can ask questions, share knowledge, explore ideas and help solve problems with fellow engineers.

Design Support *TI's Design Support* Quickly find helpful E2E forums along with design support tools and contact information for technical support.

11.5 Trademarks

E2E is a trademark of Texas Instruments.
All other trademarks are the property of their respective owners.

11.6 Electrostatic Discharge Caution



This integrated circuit can be damaged by ESD. Texas Instruments recommends that all integrated circuits be handled with appropriate precautions. Failure to observe proper handling and installation procedures can cause damage.

ESD damage can range from subtle performance degradation to complete device failure. Precision integrated circuits may be more susceptible to damage because very small parametric changes could cause the device not to meet its published specifications.

11.7 Glossary

[SLYZ022](#) — *TI Glossary*.

This glossary lists and explains terms, acronyms, and definitions.

12 Mechanical, Packaging, and Orderable Information

The following pages include mechanical, packaging, and orderable information. This information is the most current data available for the designated devices. This data is subject to change without notice and revision of this document. For browser-based versions of this data sheet, refer to the left-hand navigation.

EXAMPLE BOARD LAYOUT

DQN0004A

X2SON - 0.4 mm max height

PLASTIC SMALL OUTLINE - NO LEAD



LAND PATTERN EXAMPLE
SCALE: 40X

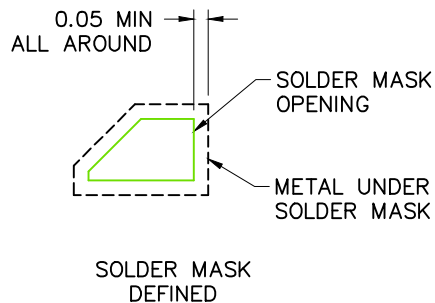

SOLDER MASK DEFINED
SOLDER MASK DETAIL

4215302/D 06/2016

NOTES: (continued)

5. This package is designed to be soldered to a thermal pad on the board. For more information, see Texas Instruments literature number SLUA271 (www.ti.com/lit/sluea271).
6. If any vias are implemented, it is recommended that vias under paste be filled, plugged or tented.

EXAMPLE STENCIL DESIGN

DQN0004A

X2SON - 0.4 mm max height

PLASTIC SMALL OUTLINE - NO LEAD



SOLDER PASTE EXAMPLE
 BASED ON 0.075 – 0.1mm THICK STENCIL

EXPOSED PAD
 88% PRINTED SOLDER COVERAGE BY AREA
 SCALE: 60X

4215302/D 06/2016

NOTES: (continued)

- 7. Laser cutting apertures with trapezoidal walls and rounded corners may offer better paste release. IPC-7525 may have alternate design recommendations.

PACKAGING INFORMATION

Orderable part number	Status (1)	Material type (2)	Package Pins	Package qty Carrier	RoHS (3)	Lead finish/ Ball material (4)	MSL rating/ Peak reflow (5)	Op temp (°C)	Part marking (6)
TLV743105PDBVR	Active	Production	SOT-23 (DBV) 5	3000 LARGE T&R	Yes	Call TI Sn Nipdau	Level-1-260C-UNLIM	-40 to 125	1NGT
TLV743105PDBVR.A	Active	Production	SOT-23 (DBV) 5	3000 LARGE T&R	Yes	NIPDAU	Level-1-260C-UNLIM	-40 to 125	1NGT
TLV74310PDBVR	Active	Production	SOT-23 (DBV) 5	3000 LARGE T&R	Yes	Call TI Sn Nipdau	Level-1-260C-UNLIM	-40 to 125	1CCT
TLV74310PDBVR.A	Active	Production	SOT-23 (DBV) 5	3000 LARGE T&R	Yes	NIPDAU	Level-1-260C-UNLIM	-40 to 125	1CCT
TLV74310PDQNR	Active	Production	X2SON (DQN) 4	3000 LARGE T&R	Yes	NIPDAU	Level-1-260C-UNLIM	-40 to 125	8U
TLV74310PDQNR.B	Active	Production	X2SON (DQN) 4	3000 LARGE T&R	Yes	NIPDAU	Level-1-260C-UNLIM	-40 to 125	8U
TLV74311PDBVR	Active	Production	SOT-23 (DBV) 5	3000 LARGE T&R	Yes	Call TI Sn Nipdau	Level-1-260C-UNLIM	-40 to 125	1DAT
TLV74311PDBVR.A	Active	Production	SOT-23 (DBV) 5	3000 LARGE T&R	Yes	NIPDAU	Level-1-260C-UNLIM	-40 to 125	1DAT
TLV74311PDQNR	Active	Production	X2SON (DQN) 4	3000 LARGE T&R	Yes	NIPDAU	Level-1-260C-UNLIM	-40 to 125	8W
TLV74311PDQNR.B	Active	Production	X2SON (DQN) 4	3000 LARGE T&R	Yes	NIPDAU	Level-1-260C-UNLIM	-40 to 125	8W
TLV74312PDBVR	Active	Production	SOT-23 (DBV) 5	3000 LARGE T&R	Yes	Call TI Sn Nipdau	Level-1-260C-UNLIM	-40 to 125	1DBT
TLV74312PDBVR.A	Active	Production	SOT-23 (DBV) 5	3000 LARGE T&R	Yes	NIPDAU	Level-1-260C-UNLIM	-40 to 125	1DBT
TLV74312PDQNR	Active	Production	X2SON (DQN) 4	3000 LARGE T&R	Yes	NIPDAU	Level-1-260C-UNLIM	-40 to 125	8X
TLV74312PDQNR.B	Active	Production	X2SON (DQN) 4	3000 LARGE T&R	Yes	NIPDAU	Level-1-260C-UNLIM	-40 to 125	8X
TLV74312PDQNR3	Active	Production	X2SON (DQN) 4	3000 LARGE T&R	Yes	NIPDAU	Level-1-260C-UNLIM	-40 to 125	8X
TLV74312PDQNR3.B	Active	Production	X2SON (DQN) 4	3000 LARGE T&R	Yes	NIPDAU	Level-1-260C-UNLIM	-40 to 125	8X
TLV74315PDBVR	Active	Production	SOT-23 (DBV) 5	3000 LARGE T&R	Yes	Call TI Sn Nipdau	Level-1-260C-UNLIM	-40 to 125	1DCT
TLV74315PDBVR.A	Active	Production	SOT-23 (DBV) 5	3000 LARGE T&R	Yes	NIPDAU	Level-1-260C-UNLIM	-40 to 125	1DCT
TLV74315PDQNR	Active	Production	X2SON (DQN) 4	3000 LARGE T&R	Yes	NIPDAU	Level-1-260C-UNLIM	-40 to 125	8Z
TLV74315PDQNR.B	Active	Production	X2SON (DQN) 4	3000 LARGE T&R	Yes	NIPDAU	Level-1-260C-UNLIM	-40 to 125	8Z
TLV74318PDBVR	Active	Production	SOT-23 (DBV) 5	3000 LARGE T&R	Yes	NIPDAU SN	Level-1-260C-UNLIM	-40 to 125	1D7T
TLV74318PDBVR.A	Active	Production	SOT-23 (DBV) 5	3000 LARGE T&R	Yes	NIPDAU	Level-1-260C-UNLIM	-40 to 125	1D7T
TLV74318PDQNR	Active	Production	X2SON (DQN) 4	3000 LARGE T&R	Yes	NIPDAU	Level-1-260C-UNLIM	-40 to 125	9A
TLV74318PDQNR.B	Active	Production	X2SON (DQN) 4	3000 LARGE T&R	Yes	NIPDAU	Level-1-260C-UNLIM	-40 to 125	9A
TLV74318PDQNR3	Active	Production	X2SON (DQN) 4	3000 LARGE T&R	Yes	NIPDAU NIPDAU	Level-1-260C-UNLIM	-40 to 125	9A
TLV74318PDQNR3.A	Active	Production	X2SON (DQN) 4	3000 LARGE T&R	Yes	NIPDAU	Level-1-260C-UNLIM	-40 to 125	9A
TLV74325PDBVR	Active	Production	SOT-23 (DBV) 5	3000 LARGE T&R	Yes	Call TI Sn Nipdau	Level-1-260C-UNLIM	-40 to 125	1DDT
TLV74325PDBVR.A	Active	Production	SOT-23 (DBV) 5	3000 LARGE T&R	Yes	NIPDAU	Level-1-260C-UNLIM	-40 to 125	1DDT
TLV74325PDQNR	Active	Production	X2SON (DQN) 4	3000 LARGE T&R	Yes	NIPDAU	Level-1-260C-UNLIM	-40 to 125	9B

Orderable part number	Status (1)	Material type (2)	Package Pins	Package qty Carrier	RoHS (3)	Lead finish/ Ball material (4)	MSL rating/ Peak reflow (5)	Op temp (°C)	Part marking (6)
TLV74325PDQNR.B	Active	Production	X2SON (DQN) 4	3000 LARGE T&R	Yes	NIPDAU	Level-1-260C-UNLIM	-40 to 125	9B
TLV743285PDBVR	Active	Production	SOT-23 (DBV) 5	3000 LARGE T&R	Yes	Call TI Sn Nipdau	Level-1-260C-UNLIM	-40 to 125	1DET
TLV743285PDBVR.A	Active	Production	SOT-23 (DBV) 5	3000 LARGE T&R	Yes	NIPDAU	Level-1-260C-UNLIM	-40 to 125	1DET
TLV743285PDQNR	Active	Production	X2SON (DQN) 4	3000 LARGE T&R	Yes	NIPDAU	Level-1-260C-UNLIM	-40 to 125	9C
TLV743285PDQNR.B	Active	Production	X2SON (DQN) 4	3000 LARGE T&R	Yes	NIPDAU	Level-1-260C-UNLIM	-40 to 125	9C
TLV74328PDBVR	Active	Production	SOT-23 (DBV) 5	3000 LARGE T&R	Yes	Call TI Sn Nipdau	Level-1-260C-UNLIM	-40 to 125	1DFT
TLV74328PDBVR.A	Active	Production	SOT-23 (DBV) 5	3000 LARGE T&R	Yes	NIPDAU	Level-1-260C-UNLIM	-40 to 125	1DFT
TLV74328PDQNR	Active	Production	X2SON (DQN) 4	3000 LARGE T&R	Yes	NIPDAU	Level-1-260C-UNLIM	-40 to 125	9D
TLV74328PDQNR.B	Active	Production	X2SON (DQN) 4	3000 LARGE T&R	Yes	NIPDAU	Level-1-260C-UNLIM	-40 to 125	9D
TLV74328PDQNR1	Active	Production	X2SON (DQN) 4	3000 LARGE T&R	Yes	NIPDAU NIPDAU	Level-1-260C-UNLIM	-40 to 125	9D
TLV74328PDQNR1.A	Active	Production	X2SON (DQN) 4	3000 LARGE T&R	Yes	NIPDAU	Level-1-260C-UNLIM	-40 to 125	9D
TLV74330PDBVR	Active	Production	SOT-23 (DBV) 5	3000 LARGE T&R	Yes	Call TI Sn Nipdau	Level-1-260C-UNLIM	-40 to 125	1DGT
TLV74330PDBVR.A	Active	Production	SOT-23 (DBV) 5	3000 LARGE T&R	Yes	Call TI	Level-1-260C-UNLIM	-40 to 125	1DGT
TLV74330PDQNR	Active	Production	X2SON (DQN) 4	3000 LARGE T&R	Yes	NIPDAU	Level-1-260C-UNLIM	-40 to 125	9E
TLV74330PDQNR.B	Active	Production	X2SON (DQN) 4	3000 LARGE T&R	Yes	NIPDAU	Level-1-260C-UNLIM	-40 to 125	9E
TLV74333PDBVR	Active	Production	SOT-23 (DBV) 5	3000 LARGE T&R	Yes	Call TI Sn Nipdau	Level-1-260C-UNLIM	-40 to 125	1CBT
TLV74333PDBVR.A	Active	Production	SOT-23 (DBV) 5	3000 LARGE T&R	Yes	Call TI	Level-1-260C-UNLIM	-40 to 125	1CBT
TLV74333PDQNR	Active	Production	X2SON (DQN) 4	3000 LARGE T&R	Yes	NIPDAU	Level-1-260C-UNLIM	-40 to 125	9F
TLV74333PDQNR.B	Active	Production	X2SON (DQN) 4	3000 LARGE T&R	Yes	NIPDAU	Level-1-260C-UNLIM	-40 to 125	9F
TLV74333PDQNR3	Active	Production	X2SON (DQN) 4	3000 LARGE T&R	Yes	NIPDAU	Level-1-260C-UNLIM	-40 to 125	9F
TLV74333PDQNR3.B	Active	Production	X2SON (DQN) 4	3000 LARGE T&R	Yes	NIPDAU	Level-1-260C-UNLIM	-40 to 125	9F
TLV74333PDQNRG4	Active	Production	X2SON (DQN) 4	3000 LARGE T&R	Yes	NIPDAU	Level-1-260C-UNLIM	-40 to 125	9F
TLV74333PDQNRG4.B	Active	Production	X2SON (DQN) 4	3000 LARGE T&R	Yes	NIPDAU	Level-1-260C-UNLIM	-40 to 125	9F

⁽¹⁾ **Status:** For more details on status, see our [product life cycle](#).

⁽²⁾ **Material type:** When designated, preproduction parts are prototypes/experimental devices, and are not yet approved or released for full production. Testing and final process, including without limitation quality assurance, reliability performance testing, and/or process qualification, may not yet be complete, and this item is subject to further changes or possible discontinuation. If available for ordering, purchases will be subject to an additional waiver at checkout, and are intended for early internal evaluation purposes only. These items are sold without warranties of any kind.

⁽³⁾ **RoHS values:** Yes, No, RoHS Exempt. See the [TI RoHS Statement](#) for additional information and value definition.

- (4) **Lead finish/Ball material:** Parts may have multiple material finish options. Finish options are separated by a vertical ruled line. Lead finish/Ball material values may wrap to two lines if the finish value exceeds the maximum column width.
- (5) **MSL rating/Peak reflow:** The moisture sensitivity level ratings and peak solder (reflow) temperatures. In the event that a part has multiple moisture sensitivity ratings, only the lowest level per JEDEC standards is shown. Refer to the shipping label for the actual reflow temperature that will be used to mount the part to the printed circuit board.
- (6) **Part marking:** There may be an additional marking, which relates to the logo, the lot trace code information, or the environmental category of the part.

Multiple part markings will be inside parentheses. Only one part marking contained in parentheses and separated by a "~" will appear on a part. If a line is indented then it is a continuation of the previous line and the two combined represent the entire part marking for that device.

Important Information and Disclaimer: The information provided on this page represents TI's knowledge and belief as of the date that it is provided. TI bases its knowledge and belief on information provided by third parties, and makes no representation or warranty as to the accuracy of such information. Efforts are underway to better integrate information from third parties. TI has taken and continues to take reasonable steps to provide representative and accurate information but may not have conducted destructive testing or chemical analysis on incoming materials and chemicals. TI and TI suppliers consider certain information to be proprietary, and thus CAS numbers and other limited information may not be available for release.

In no event shall TI's liability arising out of such information exceed the total purchase price of the TI part(s) at issue in this document sold by TI to Customer on an annual basis.

TAPE AND REEL INFORMATION



QUADRANT ASSIGNMENTS FOR PIN 1 ORIENTATION IN TAPE



*All dimensions are nominal

Device	Package Type	Package Drawing	Pins	SPQ	Reel Diameter (mm)	Reel Width W1 (mm)	A0 (mm)	B0 (mm)	K0 (mm)	P1 (mm)	W (mm)	Pin1 Quadrant
TLV743105PDBVR	SOT-23	DBV	5	3000	180.0	8.4	3.2	3.2	1.4	4.0	8.0	Q3
TLV74310PDBVR	SOT-23	DBV	5	3000	180.0	8.4	3.2	3.2	1.4	4.0	8.0	Q3
TLV74310PDQNR	X2SON	DQN	4	3000	180.0	8.4	1.16	1.16	0.5	4.0	8.0	Q2
TLV74311PDBVR	SOT-23	DBV	5	3000	180.0	8.4	3.2	3.2	1.4	4.0	8.0	Q3
TLV74311PDQNR	X2SON	DQN	4	3000	180.0	8.4	1.16	1.16	0.5	4.0	8.0	Q2
TLV74312PDBVR	SOT-23	DBV	5	3000	180.0	8.4	3.2	3.2	1.4	4.0	8.0	Q3
TLV74312PDQNR	X2SON	DQN	4	3000	180.0	8.4	1.16	1.16	0.5	4.0	8.0	Q2
TLV74312PDQNR3	X2SON	DQN	4	3000	180.0	8.4	1.16	1.16	0.5	4.0	8.0	Q3
TLV74315PDBVR	SOT-23	DBV	5	3000	178.0	9.0	3.3	3.2	1.4	4.0	8.0	Q3
TLV74315PDBVR	SOT-23	DBV	5	3000	180.0	8.4	3.2	3.2	1.4	4.0	8.0	Q3
TLV74315PDQNR	X2SON	DQN	4	3000	180.0	8.4	1.16	1.16	0.5	4.0	8.0	Q2
TLV74318PDBVR	SOT-23	DBV	5	3000	180.0	8.4	3.2	3.2	1.4	4.0	8.0	Q3
TLV74318PDQNR	X2SON	DQN	4	3000	180.0	8.4	1.16	1.16	0.5	4.0	8.0	Q2
TLV74318PDQNR3	X2SON	DQN	4	3000	180.0	8.4	1.16	1.16	0.5	4.0	8.0	Q3
TLV74325PDBVR	SOT-23	DBV	5	3000	180.0	8.4	3.2	3.2	1.4	4.0	8.0	Q3
TLV74325PDQNR	X2SON	DQN	4	3000	180.0	8.4	1.16	1.16	0.5	4.0	8.0	Q2

Device	Package Type	Package Drawing	Pins	SPQ	Reel Diameter (mm)	Reel Width W1 (mm)	A0 (mm)	B0 (mm)	K0 (mm)	P1 (mm)	W (mm)	Pin1 Quadrant
TLV743285PDBVR	SOT-23	DBV	5	3000	180.0	8.4	3.2	3.2	1.4	4.0	8.0	Q3
TLV743285PDQNR	X2SON	DQN	4	3000	180.0	8.4	1.16	1.16	0.5	4.0	8.0	Q2
TLV74328PDBVR	SOT-23	DBV	5	3000	180.0	8.4	3.2	3.2	1.4	4.0	8.0	Q3
TLV74328PDQNR	X2SON	DQN	4	3000	180.0	8.4	1.16	1.16	0.5	4.0	8.0	Q2
TLV74328PDQNR1	X2SON	DQN	4	3000	180.0	8.4	1.16	1.16	0.5	4.0	8.0	Q1
TLV74330PDBVR	SOT-23	DBV	5	3000	180.0	8.4	3.2	3.2	1.4	4.0	8.0	Q3
TLV74330PDQNR	X2SON	DQN	4	3000	180.0	8.4	1.16	1.16	0.5	4.0	8.0	Q2
TLV74333PDBVR	SOT-23	DBV	5	3000	180.0	8.4	3.2	3.2	1.4	4.0	8.0	Q3
TLV74333PDQNR	X2SON	DQN	4	3000	180.0	8.4	1.16	1.16	0.5	4.0	8.0	Q2
TLV74333PDQNR3	X2SON	DQN	4	3000	180.0	8.4	1.16	1.16	0.5	4.0	8.0	Q3
TLV74333PDQNRG4	X2SON	DQN	4	3000	180.0	8.4	1.16	1.16	0.5	4.0	8.0	Q2

TAPE AND REEL BOX DIMENSIONS

*All dimensions are nominal

Device	Package Type	Package Drawing	Pins	SPQ	Length (mm)	Width (mm)	Height (mm)
TLV743105PDBVR	SOT-23	DBV	5	3000	210.0	185.0	35.0
TLV74310PDBVR	SOT-23	DBV	5	3000	210.0	185.0	35.0
TLV74310PDQNR	X2SON	DQN	4	3000	210.0	185.0	35.0
TLV74311PDBVR	SOT-23	DBV	5	3000	210.0	185.0	35.0
TLV74311PDQNR	X2SON	DQN	4	3000	210.0	185.0	35.0
TLV74312PDBVR	SOT-23	DBV	5	3000	210.0	185.0	35.0
TLV74312PDQNR	X2SON	DQN	4	3000	210.0	185.0	35.0
TLV74312PDQNR3	X2SON	DQN	4	3000	210.0	185.0	35.0
TLV74315PDBVR	SOT-23	DBV	5	3000	180.0	180.0	18.0
TLV74315PDBVR	SOT-23	DBV	5	3000	210.0	185.0	35.0
TLV74315PDQNR	X2SON	DQN	4	3000	210.0	185.0	35.0
TLV74318PDBVR	SOT-23	DBV	5	3000	210.0	185.0	35.0
TLV74318PDQNR	X2SON	DQN	4	3000	210.0	185.0	35.0
TLV74318PDQNR3	X2SON	DQN	4	3000	210.0	185.0	35.0
TLV74325PDBVR	SOT-23	DBV	5	3000	210.0	185.0	35.0
TLV74325PDQNR	X2SON	DQN	4	3000	210.0	185.0	35.0
TLV743285PDBVR	SOT-23	DBV	5	3000	210.0	185.0	35.0
TLV743285PDQNR	X2SON	DQN	4	3000	210.0	185.0	35.0

Device	Package Type	Package Drawing	Pins	SPQ	Length (mm)	Width (mm)	Height (mm)
TLV74328PDBVR	SOT-23	DBV	5	3000	210.0	185.0	35.0
TLV74328PDQNR	X2SON	DQN	4	3000	210.0	185.0	35.0
TLV74328PDQNR1	X2SON	DQN	4	3000	210.0	185.0	35.0
TLV74330PDBVR	SOT-23	DBV	5	3000	210.0	185.0	35.0
TLV74330PDQNR	X2SON	DQN	4	3000	210.0	185.0	35.0
TLV74333PDBVR	SOT-23	DBV	5	3000	210.0	185.0	35.0
TLV74333PDQNR	X2SON	DQN	4	3000	210.0	185.0	35.0
TLV74333PDQNR3	X2SON	DQN	4	3000	210.0	185.0	35.0
TLV74333PDQNRG4	X2SON	DQN	4	3000	210.0	185.0	35.0

GENERIC PACKAGE VIEW

DQN 4

X2SON - 0.4 mm max height

PLASTIC SMALL OUTLINE - NO LEAD



Images above are just a representation of the package family, actual package may vary.
Refer to the product data sheet for package details.

4210367/F



LAND PATTERN EXAMPLE
SCALE: 40X



SOLDER MASK DETAIL

4215302/E 12/2016

NOTES: (continued)

7. This package is designed to be soldered to a thermal pad on the board. For more information, see Texas Instruments literature number SLUA271 (www.ti.com/lit/sluea271).
8. If any vias are implemented, it is recommended that vias under paste be filled, plugged or tented.



SOLDER PASTE EXAMPLE
 BASED ON 0.075 - 0.1mm THICK STENCIL
 EXPOSED PAD
 88% PRINTED SOLDER COVERAGE BY AREA
 SCALE: 60X

4215302/E 12/2016

NOTES: (continued)

9. Laser cutting apertures with trapezoidal walls and rounded corners may offer better paste release. IPC-7525 may have alternate design recommendations.

EXAMPLE BOARD LAYOUT

DBV0005A

SOT-23 - 1.45 mm max height

SMALL OUTLINE TRANSISTOR



LAND PATTERN EXAMPLE
EXPOSED METAL SHOWN
SCALE:15X



SOLDER MASK DETAILS

4214839/K 08/2024

NOTES: (continued)

- 6. Publication IPC-7351 may have alternate designs.
- 7. Solder mask tolerances between and around signal pads can vary based on board fabrication site.

EXAMPLE STENCIL DESIGN

DBV0005A

SOT-23 - 1.45 mm max height

SMALL OUTLINE TRANSISTOR



SOLDER PASTE EXAMPLE
BASED ON 0.125 mm THICK STENCIL
SCALE:15X

4214839/K 08/2024

NOTES: (continued)

8. Laser cutting apertures with trapezoidal walls and rounded corners may offer better paste release. IPC-7525 may have alternate design recommendations.
9. Board assembly site may have different recommendations for stencil design.

IMPORTANT NOTICE AND DISCLAIMER

TI PROVIDES TECHNICAL AND RELIABILITY DATA (INCLUDING DATA SHEETS), DESIGN RESOURCES (INCLUDING REFERENCE DESIGNS), APPLICATION OR OTHER DESIGN ADVICE, WEB TOOLS, SAFETY INFORMATION, AND OTHER RESOURCES "AS IS" AND WITH ALL FAULTS, AND DISCLAIMS ALL WARRANTIES, EXPRESS AND IMPLIED, INCLUDING WITHOUT LIMITATION ANY IMPLIED WARRANTIES OF MERCHANTABILITY, FITNESS FOR A PARTICULAR PURPOSE OR NON-INFRINGEMENT OF THIRD PARTY INTELLECTUAL PROPERTY RIGHTS.

These resources are intended for skilled developers designing with TI products. You are solely responsible for (1) selecting the appropriate TI products for your application, (2) designing, validating and testing your application, and (3) ensuring your application meets applicable standards, and any other safety, security, regulatory or other requirements.

These resources are subject to change without notice. TI grants you permission to use these resources only for development of an application that uses the TI products described in the resource. Other reproduction and display of these resources is prohibited. No license is granted to any other TI intellectual property right or to any third party intellectual property right. TI disclaims responsibility for, and you will fully indemnify TI and its representatives against, any claims, damages, costs, losses, and liabilities arising out of your use of these resources.

TI's products are provided subject to [TI's Terms of Sale](#) or other applicable terms available either on [ti.com](https://www.ti.com) or provided in conjunction with such TI products. TI's provision of these resources does not expand or otherwise alter TI's applicable warranties or warranty disclaimers for TI products.

TI objects to and rejects any additional or different terms you may have proposed.

Mailing Address: Texas Instruments, Post Office Box 655303, Dallas, Texas 75265

Copyright © 2025, Texas Instruments Incorporated