



# Crystal Unit

## ■ NX2016SA Data Sheet (for Short-Range Wireless and OA / AV)

### Application

Communications equipment  
Short-range wireless equipment  
Consumer equipment

### Features

Ultra-compact and thin surface-mount crystal unit,  
especially suitable for applications requiring miniaturization

- Ultra-compact and thin (Typ. :  $2.0 \times 1.6 \times 0.45$  mm)
- Excellent environmental resistance performance such as heat and shock resistance
- Excellent electrical performance optimum for OA (Office automation), AV (audiovisual), Bluetooth and Wireless LAN applications
- Reflow temperature profile (Available for lead free soldering)

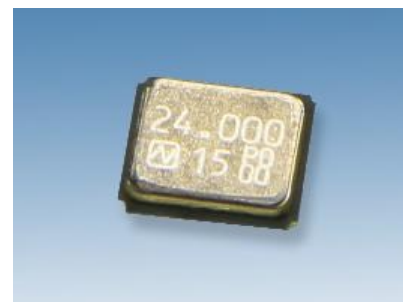

RoHS Compliant  
Directive 2011/65/EU  
Directive (EU) 2015/863

Pb free

1. Item : Crystal Unit  
 2. Type : NX2016SA  
 3. Nominal Frequency : 50 MHz  
 4. NDK Spec. No. : EXS00A-CS08483  
 5. NDK Parts No. : CS08483-50M  
 6. Electrical Specifications

	Electrical Characteristics Items	Symbol	Electrical Characteristics Spec.				Notes
			MIN	TYP	MAX	Unit	
1	Nominal frequency	$f_{nom}$	50.000			MHz	
2	Overtone order	-	Fundamental			-	
3	Frequency tolerance	-	-10	-	+10	$\times 10^{-6}$	at +25°C
4	Frequency versus temperature characteristics	-	-12	-	+12	$\times 10^{-6}$	at -30~+85°C The reference temperature shall be +25°C
		-	-35	-	+35	$\times 10^{-6}$	at -40~+105°C The reference temperature shall be +25°C
5	Frequency Aging(at +25°C)	-	-3	-	+3	$\times 10^{-6}$	1 <sup>st</sup> year
			-5	-	+5	$\times 10^{-6}$	5years
			-10	-	+10	$\times 10^{-6}$	10years
			-13	-	+13	$\times 10^{-6}$	15years
6	Equivalent resistance	-	-	-	50	$\Omega$	IEC PI-network/Series
7	Shunt capacitance	$C_0$	-30%	0.78	+30%	pF	Not grounded
8	Motional capacitance	$C_1$	-30%	2.22	+30%	fF	Not grounded
9	Motional inductance	$L_1$	-30%	4.57	+30%	mH	Not grounded
10	Pulling Sensitivity	S	-30%	14.40	+30%	$\times 10^{-6}/pF$	at $C_L=8pF$ /Not grounded $S(\times 10^{-6}/pF)=C_1/\{2*(C_0+C_L)^2\}$
11	Load capacitance	$C_L$	-	8	-	pF	IEC PI-network
12	Level of drive	-	-	10	200	$\mu W$	
13	Operating temperature range	$T_{opr}$	-40	-	+105	°C	
14	Storage temperature range	$T_{str}$	-40	-	+105	°C	
15	Insulation resistance	-	500	-	-	M $\Omega$	When terminal to terminal and terminal to cover were applied at DC100V $\pm$ 15V.
16	Air-tightness	-	-	-	$1.1 \times 10^{-9}$	Pa m <sup>3</sup> /s	

## Mounted conditions

Be sure to use the product under the following conditions. Otherwise, the characteristics deterioration or destruction of the product may result.

(1) Reflow soldering heat resistance

Peak Temp. : 265°C, 10sec.

Heating : 230°C or higher, 40sec.

Preheating : 150~180°C, 120sec.

Reflow passage times : twice

(2) Manual soldering heat resistance

Pressing a soldering iron of 400°C on the terminal electrode for four seconds (twice).

### Recommendation reflow condition

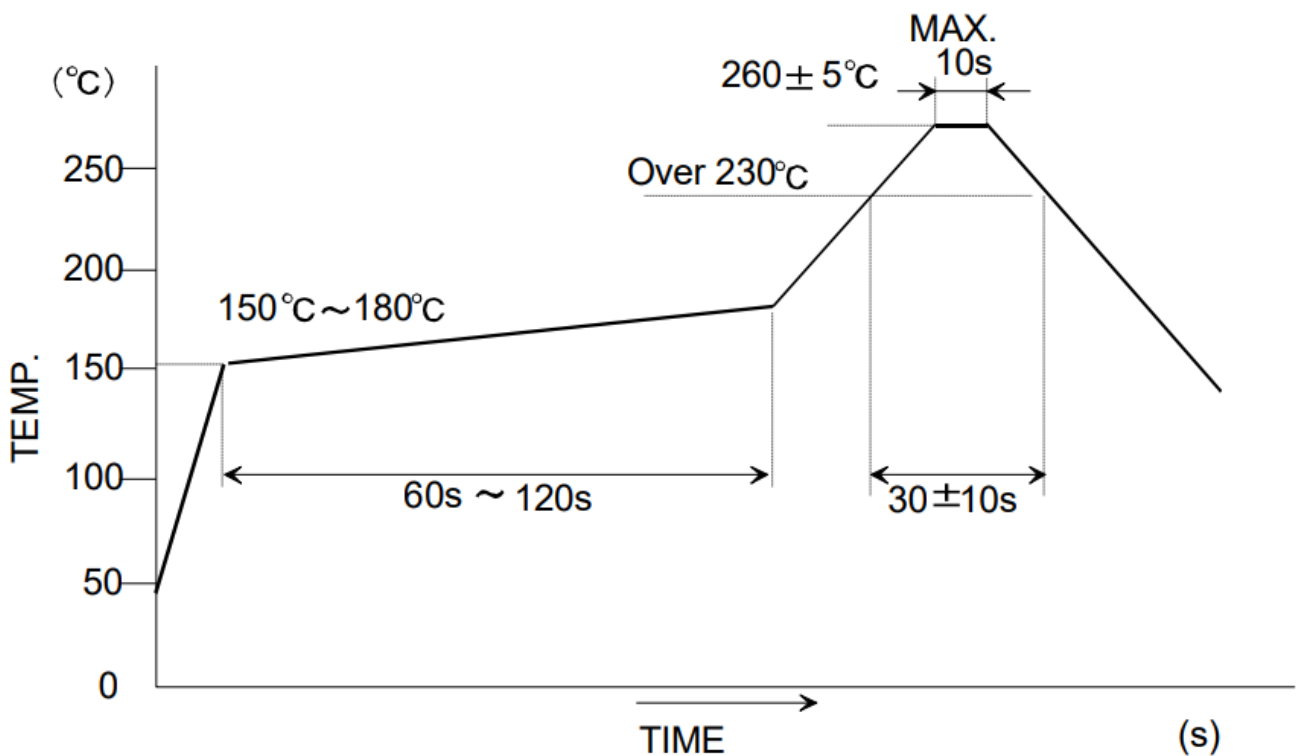

# Dimension drawing

Unit : mm

Tolerance : +/-0.1mm

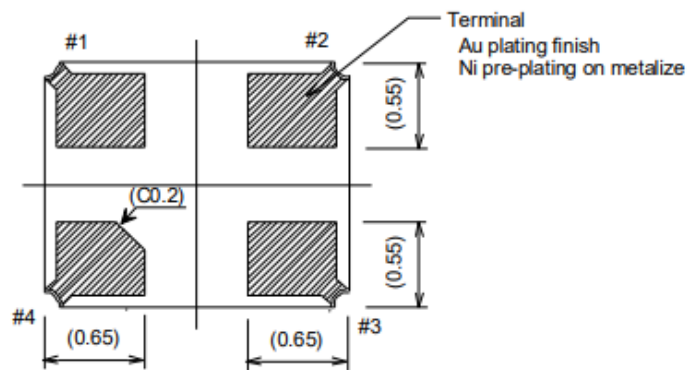
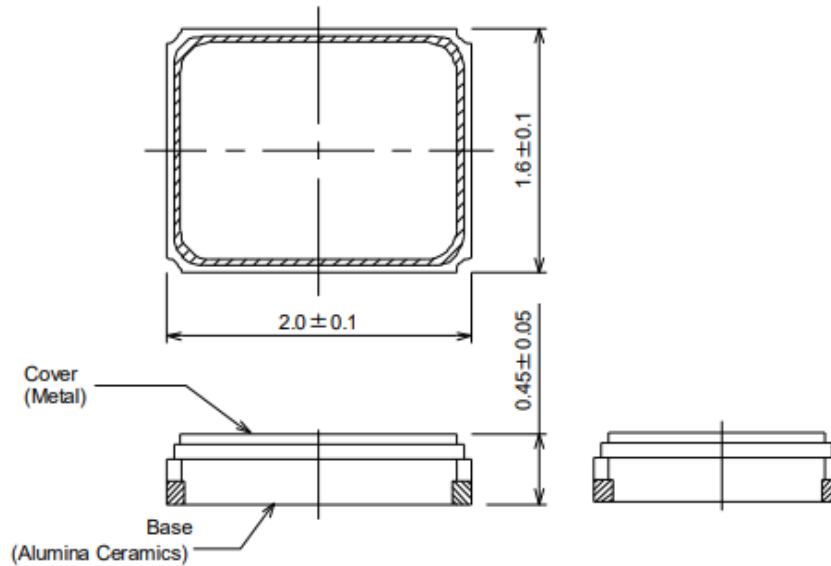

LAND PATTERN (Recommended)

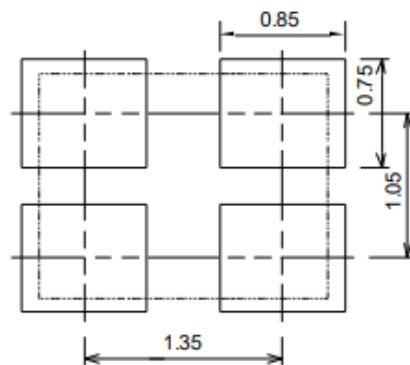

PIN CONNECTION (TOP VIEW)

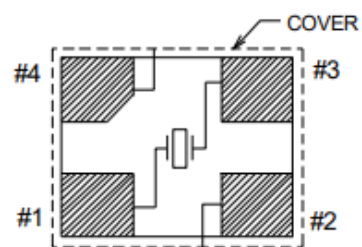

TERMINAL  
 #1, #3 : XTAL  
 #2, #4 : GND (CONNECTION WITH COVER)

### Taping and reel spec.

3,000pcs / reel (Reel dimension :  $\phi 180$  mm)

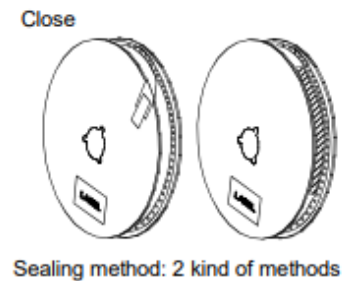
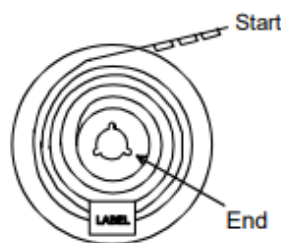
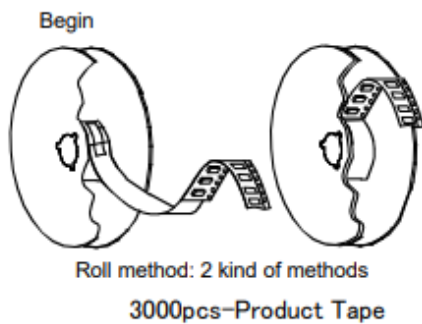
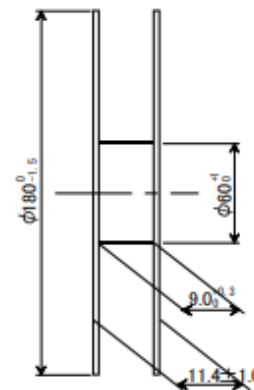
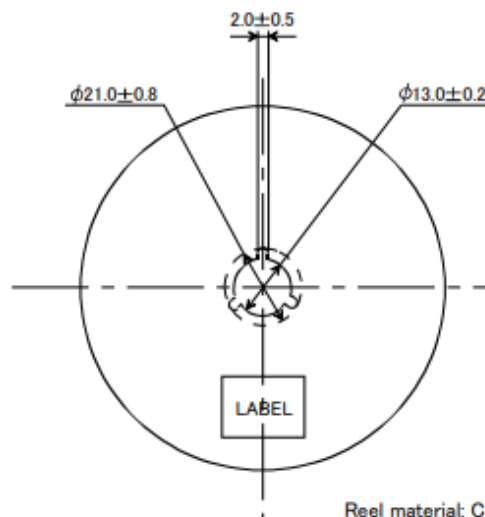
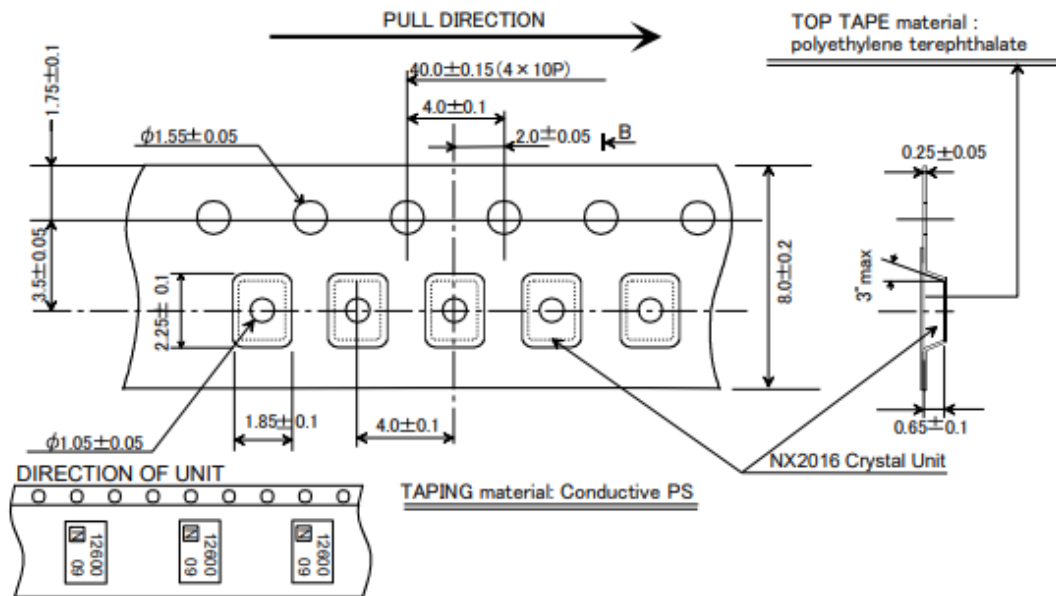

Marking spec.

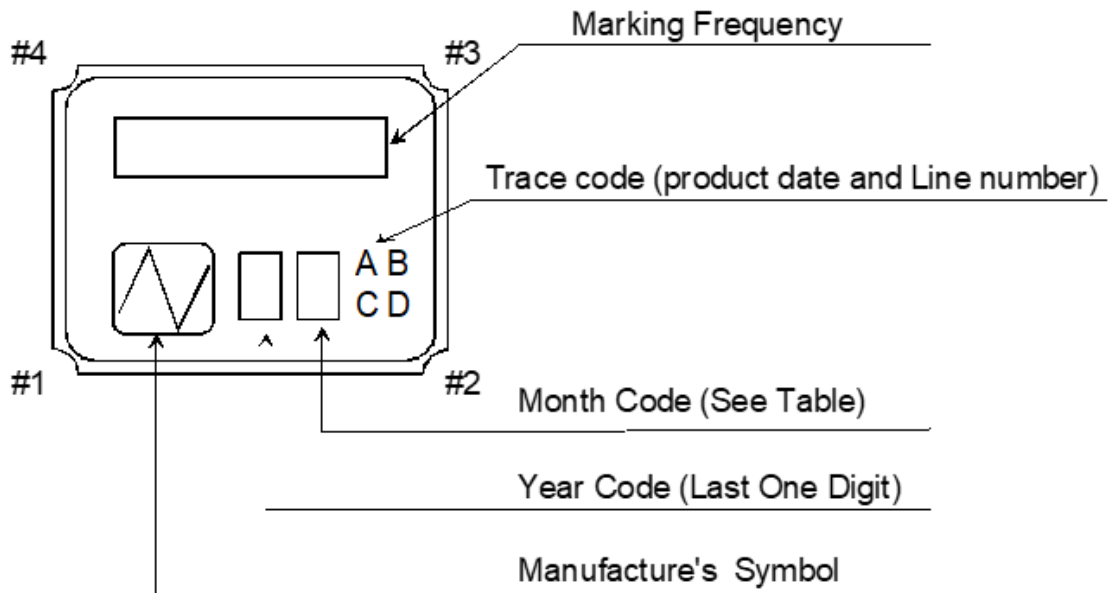

NOTE

1. Frequency Code

Marking Frequency is consist of five digits, first five digits of Nominal Frequency

Example

Nominal Frequency	28.636363 MHz
Frequency Code	28.636

2. Month Code Table

Month	1 Jan.	2 Feb.	3 Mar.	4 Apr.	5 May.	6 Jun.	7 Jul.	8 Aug.	9 Sep.	10 Oct.	11 Nov.	12 Dec.
Month Code	1	2	3	4	5	6	7	8	9	X	Y	Z

\*Marking digits are not include a decimal point and dot mark.

**Reliability assurance item**

(page: 1/1)

No.	Test Item	Test Methods	Specific ation Code
1	High Temperature Storage	+85±3°C 720h	A
2	Low Temperature Storage	-40±3°C 500h	A
3	Temperature Humidity	+85±3°C 80~85%RH 500h	A
4	Temperature Cycling	-40±3°C / +85±3°C It is 1000 cycles using 30 minutes each as 1 cycle.	A
5	Vibration	Frequency Range : 10~2000Hz Amplitude or Acceleration : 1.52mm or 196m/s <sup>2</sup> 1 cycle : 20 minutes Test time : Three mutually perpendicular axes each 4 hours.	A
6	Shock	Devices are shocked to half sine wave (29418m/s <sup>2</sup> , 0.3msec) six mutually perpendicular axis each 1 times.	A
7	Drop	Preparation : Test pieces should be fixed on the dummy load with 200g weight. Condition : Height 1.5m onto concrete Drop times : 10 times in 6 mutually perpendicular axes	A
8	Solderability	Pre-heat temperature : +150±10°C Pre-heat time : 60~120s When the temperature of the specimen is reached at +215±3°C, it shall be left for 30±1sec. Peak temperature 240±5°C Material: Pb-free (Sn-3.0Ag-0.5Cu) Flux : Rosin resin methyl alcohol solvent ( 1 : 4 )	B
9	Reflow resistance	Pre-heat temperature : +150~180°C Pre-heat time : 90±30s Heat temperature : more than +230°C Heat time : 30s ±10s Peak temperature : +260±5°C Peak time : less than 10s	A

Specification code	Specification
A	$\Delta f/f \leq \pm 3$ ppm $\Delta CI/CI \leq \pm 15$ % or 5 $\Omega$ make use larger value
B	The electrodes should be covered by a new solder at least 90% of immersed area.

## Notes on use

1. Even if the appearance color etc. of the product differs by purchasing the component parts by more than two companies, there is no influence on the characteristics and reliability.
2. Since the crystal unit is a passive component, it is important to have appropriate circuit conditions. Please be sure to check the circuit conditions before using the crystal units, and ensure the necessary circuit margin, and confirm that the desired frequency is output. Moreover, please check the circuit conditions when using an existing crystal unit for another model or board. If the circuit conditions are not appropriate, there is a risk of oscillation stop or frequency deviation.
3. IN THE CASE OF THE FOLLOWING ITEMS, WE ARE NOT RESPONSIBLE FOR WARRANTY / COMPENSATION.
  - (1) WHEN PRODUCTS OF THIS SPECIFICATION ARE USED FOR EQUIPMENT RELATED TO HUMAN LIFE OR PROPERTY, IT IS THE RESPONSIBILITY OF THE CUSTOMER TO CONFIRM THE INFLUENCE ON THIS PRODUCT AND EQUIPMENT TO BE USED BEFOREHAND, CONDUCT NECESSARY SAFETY DESIGN (INCLUDING REDUNDANT DESIGN, MALFUNCTION PREVENTION DESIGN, etc.), AND PLEASE USE IT AFTER SECURING SUFFICIENT SAFETY OF EQUIPMENT.
    1. SAFETY-RELATED EQUIPMENT SUCH AS AUTOMOBILES, TRAINS, SHIPS, etc., OR EQUIPMENT DIRECTLY INVOLVED IN OPERATION
    2. AIRCRAFT EQUIPMENT
    3. SPACE EQUIPMENT
    4. MEDICAL EQUIPMENT
    5. MILITARY EQUIPMENT
    6. DISASTER PREVENTION / CRIME PREVENTION EQUIPMENT
    7. TRAFFIC LIGHT
    8. OTHER EQUIPMENT REQUIRING THE SAME PERFORMANCE AS THE ABOVE-MENTIONED EQUIPMENT
  - (2) IN CASES WHERE IT IS NOT INDICATED IN THE REQUESTED STANDARD AND IS USED UNDER CONDITIONS OF USE (INCLUDING CIRCUIT MARGIN etc.) THAT CAN NOT BE PREDICTED AT THE PRODUCTION STAGE.
  - (3) WHEN USING ULTRASONIC WELDING MACHINE. (THERE IS A POSSIBILITY THAT THE CHARACTERISTIC DEGRADATION IS CAUSED BY THE RESONANCE PHENOMENON OF THE PIEZOELECTRIC MATERIAL.(EXAMPLE; CRYSTAL PIECE))  
WE WILL NOT TAKE ANY RESPONSIBILITY FOR THE INFLUENCE OF THE CUSTOMERS' PROCESS.SO, PLEASE SUFFICIENTLY EVALUATE AT A SAMPLE STEP WHEN YOU USE ULTRASONIC WELDING MACHINE.
  - (4) USING RESIN MOLD MAY AFFECT THE PRODUCT CHARACTERISTIC.  
PLEASE MAKE SURE TO TELL OUR SALES CONTACT WHEN YOU USE RESIN MOLD. WE WILL PERFORM INDIVIDUAL CORRESPONDENCE ABOUT A DELIVERY SPECIFICATION AND AN EVALUATION METHOD. IN ADDITION, IF YOU USE RESIN MOLD WITHOUT CONTACTING US, AND CAUSES DAMAGES AGAINST A CUSTOMER OR A THIRD PARTY, WE WILL NOT BE LIABLE FOR THE DAMAGES AND OTHER RESPONSIBILITIES BECAUSE WE CONSIDER IT IS UNDER SELF-RESPONSIBILITY USING RESIN MOLD. WE WILL NOT TAKE ANY RESPONSIBILITY FOR THE INFLUENCE OF THE CUSTOMERS' PROCESS. PLEASE SUFFICIENTLY EVALUATE AT A SAMPLE STEP WHEN YOU USE RESIN MOLD.
  - (5) WHEN PERFORMING IMPROPER HANDLING THAT EXCEEDS THE GUARANTEED RANGE.

4. This product cannot be used for equipment related to the safety of automobiles or equipment directly involved in operation.(example: air bag, TPMS, engine control, steering control, brake control etc.)

## Notes on storage

1. When storing the product in high temperature and high humidity condition for a long time, product characteristics (solderability etc.) and packaging condition may be deteriorated. Please store product at temperature + 5°C ~ + 35°C, humidity 85% RH or less. The product is an electronic component, so please do not storage and use, under a dewing state.
2. The product storage deadline is 12 months after delivery in unopened state. Please use within storage deadline. If you exceed storage deadline, please check the product characteristics etc, please use.

## Handling of this document and other requests

Please refer to the " Site Guidance" on our website for the handling of information contained in this document. (<https://www.ndk.com/en/terms/>)