

Crystal Unit

■ NX2016SA Data Sheet (for Short-range Wireless and OA / AV)

Application

Telecommunications equipment
Short-range Wireless equipment
Consumer equipment

Features

- Ultra-compact and thin surface-mount crystal unit,
especially suitable for applications requiring miniaturization
- Ultra-compact and thin (Typ. : 2.0×1.6×0.45 mm)
 - Excellent environmental resistance performance such as heat and shock resistance
 - Excellent electrical performance optimum for OA (Office automation), AV (audiovisual), Bluetooth and Wireless LAN applications
 - Reflow temperature profile (Available for lead free soldering)

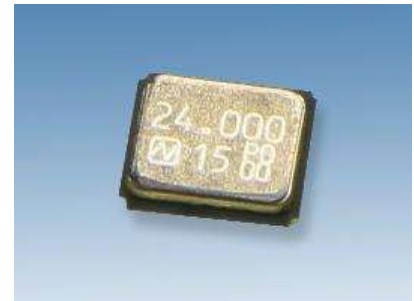

RoHS Compliant
Directive 2011/65/EU
Directive (EU) 2015/863

Pb free

1. Item : Crystal Unit
 2. Type : NX2016SA
 3. Nominal Frequency : 32 MHz
 4. NDK Spec. No. : EXS00A-CS10925
 5. NDK Parts No. : CS10925-32M

6. Electrical Specifications

7.

	Parameters	SYM.	Electrical Spec.				Notes
			min	typ	max	Units	
1	Nominal frequency	f_{nom}	32			MHz	
2	Overtone order	-	Fundamental			-	
3	Frequency tolerance	-	-20	-	+20	$\times 10^{-6}$	at +25°C
4	Frequency versus temperature characteristics	-	-30	-	+30	$\times 10^{-6}$	at -40~+85°C The reference temperature shall be +25°C
			-40	-	+40	$\times 10^{-6}$	at +85~+105 °C The reference temperature shall be +25°C
5	Frequency Aging(at +25°C)	-	-3	-	+3	$\times 10^{-6}$	1year
6	Equivalent resistance	-	-	-	80	Ω	IEC PI-network/Series
7	Shunt capacitance	C_0	-30%	0.62	+30%	pF	Not grounded
8	Motional capacitance	C_1	-30%	2.03	+30%	fF	Not grounded
9	Motional inductance	L_1	-30%	12.2	+30%	mH	Not grounded
10	Pulling Sensitivity	S	-30%	23.2	+30%	$\times 10^{-6}/pF$	at $C_L=6pF$ /Not grounded $S(\times 10^{-6}/pF)=C_1/\{2*(C_0+C_L)^2\}$
11	Load capacitance	C_L	-	6	-	pF	IEC PI-network
12	Level of drive	-	-	10	200	μW	
13	Operating temperature range	T_{opr}	-40	-	+105	°C	
14	Storage temperature range	T_{str}	-40	-	+105	°C	
15	Insulation resistance	-	500	-	-	M Ω	When terminal to terminal and terminal to cover were applied at DC100V $\pm 15V$.
16	Air-tightness	-	-	-	1.1×10^{-9}	Pa m ³ /s	

Mounted conditions

Be sure to use the product under the following conditions. Otherwise, the characteristics deterioration or destruction of the product may result.

(1) Reflow soldering heat resistance

- Peak Temp. : 265°C, 10sec.
- Heating : 230°C or higher, 40sec.
- Preheating : 150~180°C, 120sec.
- Reflow passage times : twice

(2) Manual soldering heat resistance

Pressing a soldering iron of 400°C on the terminal electrode for four seconds (twice).

Recommendation reflow condition

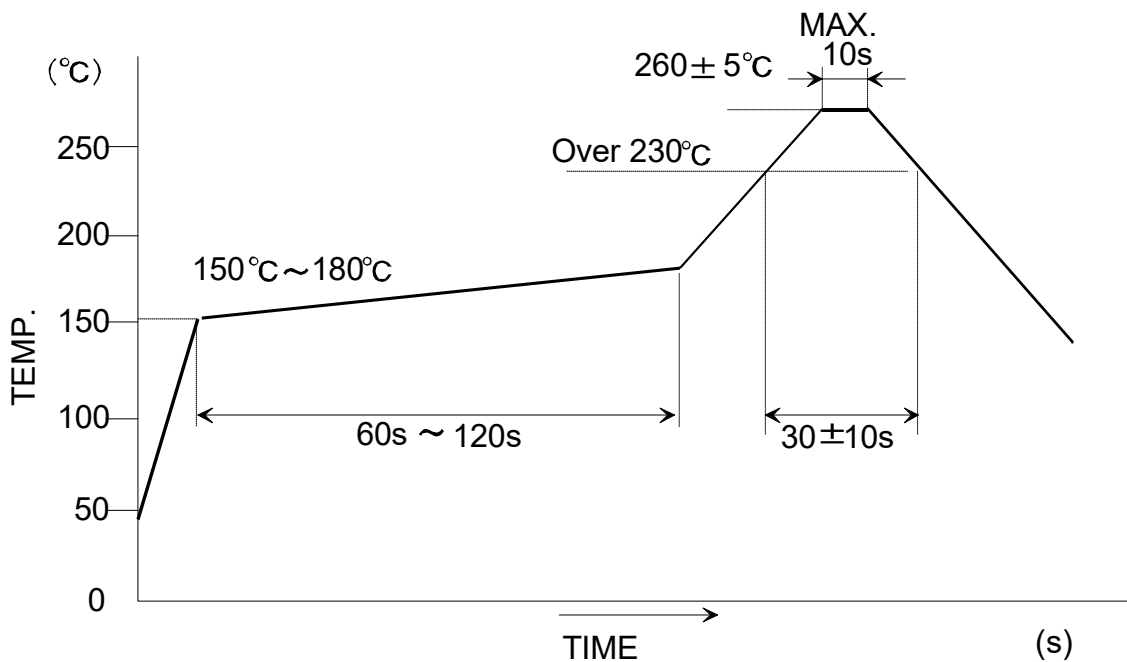

Dimension drawing

Unit : mm

Tolerance : +/-0.1mm

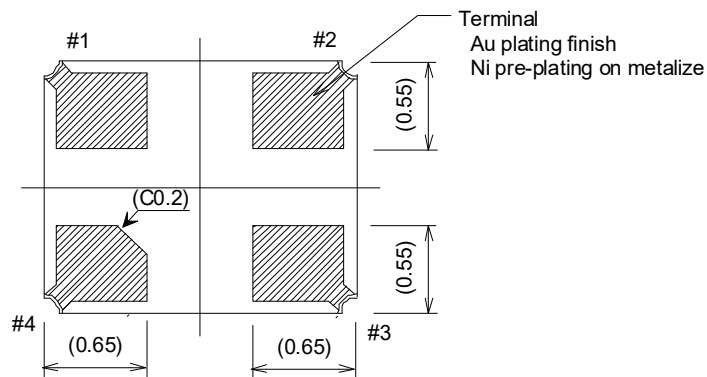
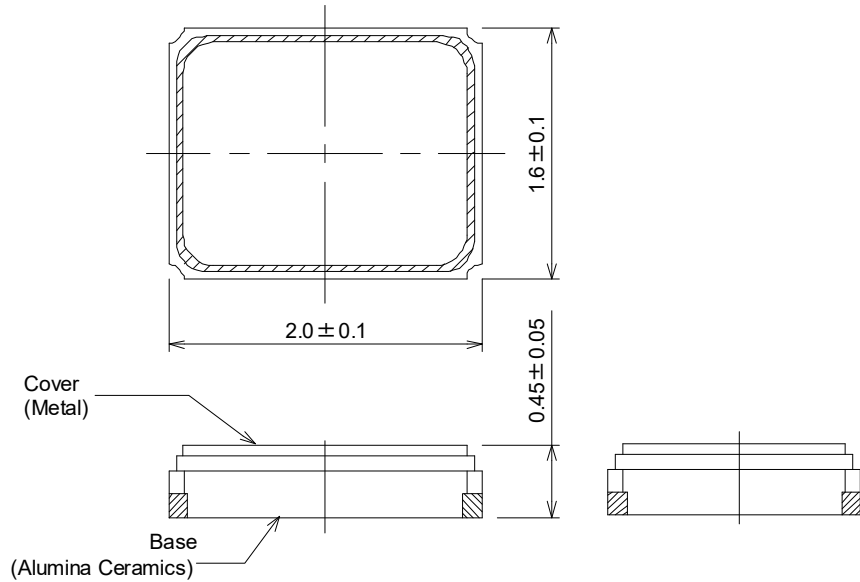

LAND PATTERN (Recommended)

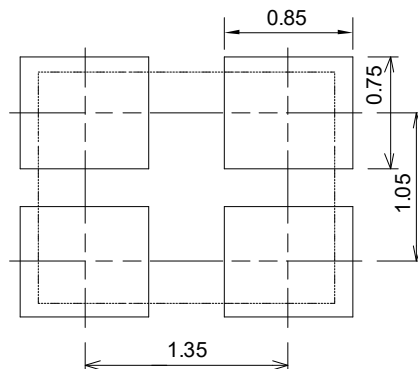

PIN CONNECTION (TOP VIEW)

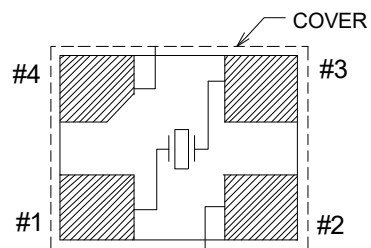

TERMINAL

#1,#3 : XTAL

#2,#4 : GND(CONNECTION WITH COVER)

Taping and reel spec. ①

3,000pcs / reel (Reel dimension : $\phi 180$ mm)

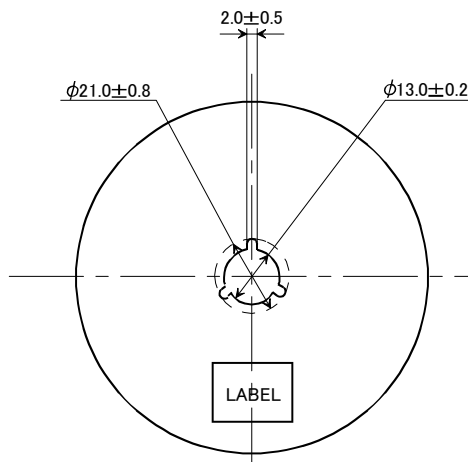
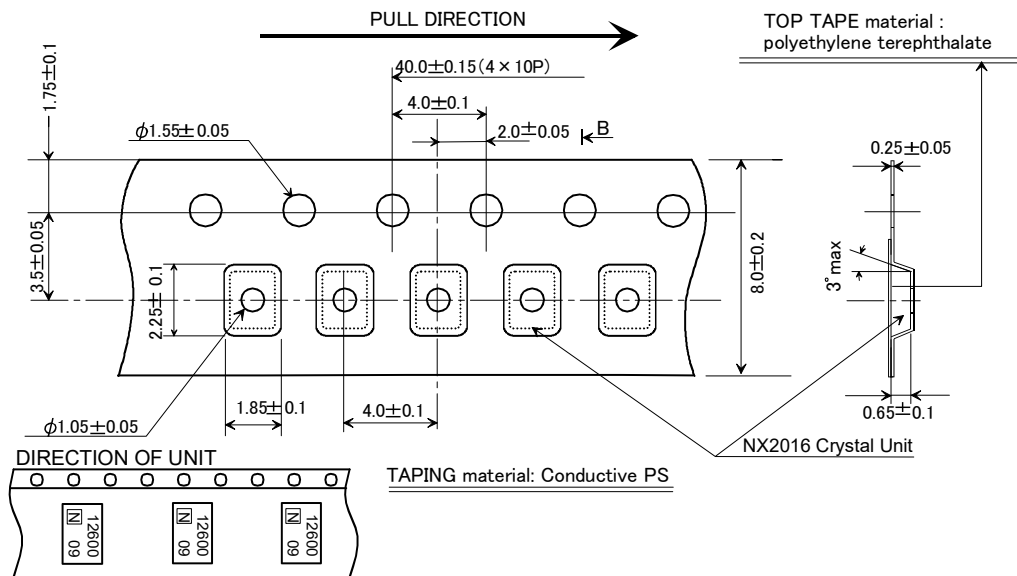

Reel material: Conductive PS
EIAJ standard reel

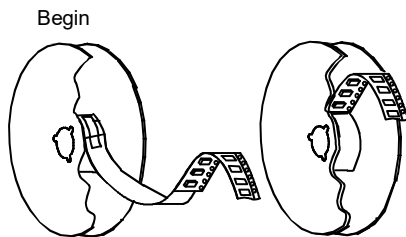
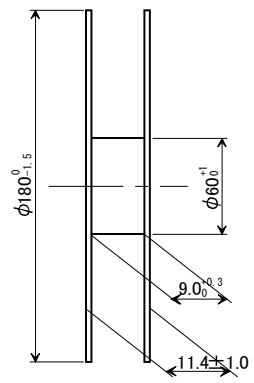

Roll method: 2 kind of methods
3000pcs-Product Tape

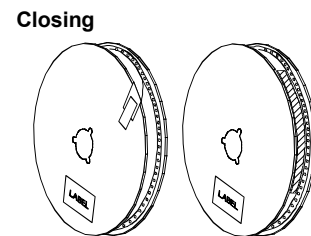
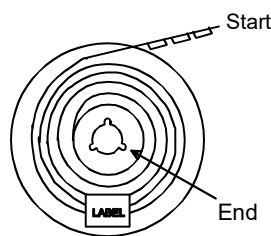

Sealing method: 2 kind of methods

Taping and reel spec.②

15,000pcs / reel (Reel dimension : $\phi 330$ mm)

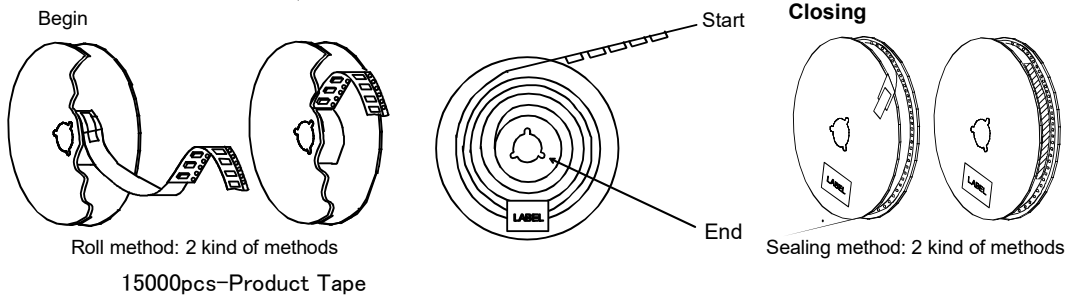
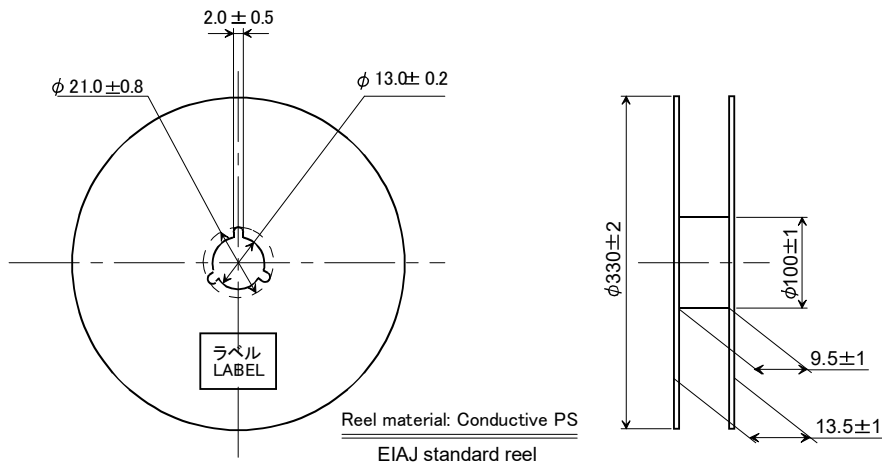
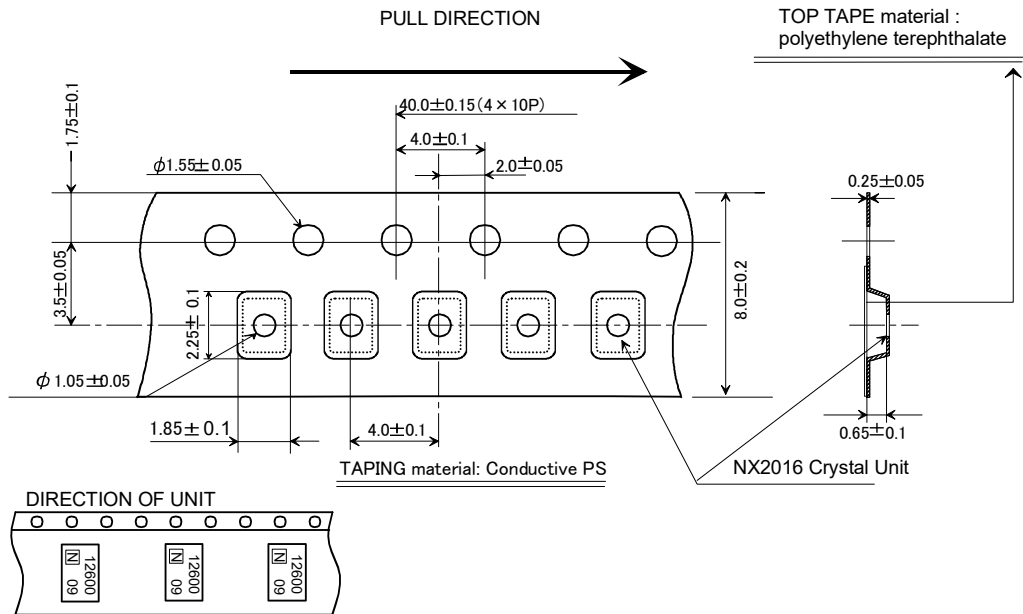

Marking spec.

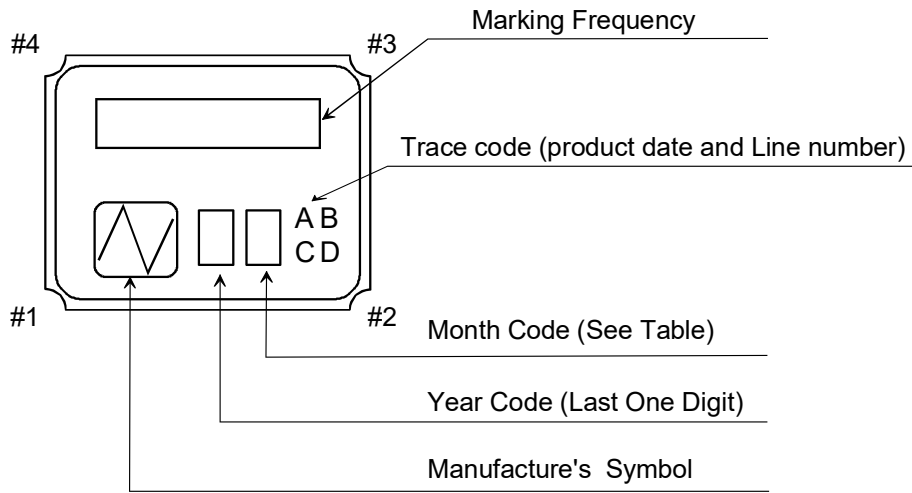

NOTE

1. Frequency Code

Marking Frequency is consist of five digits, first five digits of Nominal Frequency

Example

Nominal Frequency	28.636363 MHz
Frequency Code	28.636

2. Month Code Table

Month	1 Jan.	2 Feb.	3 Mar.	4 Apr.	5 May.	6 Jun.	7 Jul.	8 Aug.	9 Sep.	10 Oct.	11 Nov.	12 Dec.
Month Code	1	2	3	4	5	6	7	8	9	X	Y	Z

*Marking digits are not include a decimal point and dot mark.

Notes on use

1. Even if the appearance color etc. of the product differs by purchasing the component parts by more than two companies, there is no influence on the characteristics and reliability.
2. Since the crystal unit is a passive component, it is important to have appropriate circuit conditions. Please be sure to check the circuit conditions before using the crystal units, and ensure the necessary circuit margin, and confirm that the desired frequency is output. Moreover, please check the circuit conditions when using an existing crystal unit for another model or board. If the circuit conditions are not appropriate, there is a risk of oscillation stop or frequency deviation.
3. IN THE CASE OF THE FOLLOWING ITEMS, WE ARE NOT RESPONSIBLE FOR WARRANTY / COMPENSATION.
 - (1) WHEN PRODUCTS OF THIS SPECIFICATION ARE USED FOR EQUIPMENT RELATED TO HUMAN LIFE OR PROPERTY, IT IS THE RESPONSIBILITY OF THE CUSTOMER TO CONFIRM THE INFLUENCE ON THIS PRODUCT AND EQUIPMENT TO BE USED BEFOREHAND, CONDUCT NECESSARY SAFETY DESIGN (INCLUDING REDUNDANT DESIGN, MALFUNCTION PREVENTION DESIGN, etc.), AND PLEASE USE IT AFTER SECURING SUFFICIENT SAFETY OF EQUIPMENT.
 1. SAFETY-RELATED EQUIPMENT SUCH AS AUTOMOBILES, TRAINS, SHIPS, etc., OR EQUIPMENT DIRECTLY INVOLVED IN OPERATION
 2. AIRCRAFT EQUIPMENT
 3. SPACE EQUIPMENT
 4. MEDICAL EQUIPMENT
 5. MILITARY EQUIPMENT
 6. DISASTER PREVENTION / CRIME PREVENTION EQUIPMENT
 7. TRAFFIC LIGHT
 8. OTHER EQUIPMENT REQUIRING THE SAME PERFORMANCE AS THE ABOVE-MENTIONED EQUIPMENT
 - (2) IN CASES WHERE IT IS NOT INDICATED IN THE REQUESTED STANDARD AND IS USED UNDER CONDITIONS OF USE (INCLUDING CIRCUIT MARGIN etc.) THAT CAN NOT BE PREDICTED AT THE PRODUCTION STAGE.
 - (3) WHEN USING ULTRASONIC WELDING MACHINE. (THERE IS A POSSIBILITY THAT THE CHARACTERISTIC DEGRADATION IS CAUSED BY THE RESONANCE PHENOMENON OF THE PIEZOELECTRIC MATERIAL. (EXAMPLE; CRYSTAL PIECE))
WE WILL NOT TAKE ANY RESPONSIBILITY FOR THE INFLUENCE OF THE CUSTOMERS' PROCESS. SO, PLEASE SUFFICIENTLY EVALUATE AT A SAMPLE STEP WHEN YOU USE ULTRASONIC WELDING MACHINE.
 - (4) USING RESIN MOLD MAY AFFECT THE PRODUCT CHARACTERISTIC.
PLEASE MAKE SURE TO TELL OUR SALES CONTACT WHEN YOU USE RESIN MOLD. WE WILL PERFORM INDIVIDUAL CORRESPONDENCE ABOUT A DELIVERY SPECIFICATION AND AN EVALUATION METHOD. IN ADDITION, IF YOU USE RESIN MOLD WITHOUT CONTACTING US, AND CAUSES DAMAGES AGAINST A CUSTOMER OR A THIRD PARTY, WE WILL NOT BE LIABLE FOR THE DAMAGES AND OTHER RESPONSIBILITIES BECAUSE WE CONSIDER IT IS UNDER SELF-RESPONSIBILITY USING RESIN MOLD. WE WILL NOT TAKE ANY RESPONSIBILITY FOR THE INFLUENCE OF THE CUSTOMERS' PROCESS. PLEASE SUFFICIENTLY EVALUATE AT A SAMPLE STEP WHEN YOU USE RESIN MOLD.
 - (5) WHEN PERFORMING IMPROPER HANDLING THAT EXCEEDS THE GUARANTEED RANGE.

4. This product cannot be used for equipment related to the safety of automobiles or equipment directly involved in operation. (example: air bag, TPMS, engine control, steering control, brake control etc.)

Notes on storage

1. When storing the product in high temperature and high humidity condition for a long time, product characteristics (solderability etc.) and packaging condition may be deteriorated. Please store product at temperature + 5°C ~ + 35°C, humidity 85% RH or less. The product is an electronic component, so please do not storage and use, under a dewing state.
2. The product storage deadline is 12 months after delivery in unopened state. Please use within storage deadline. If you exceed storage deadline, please check the product characteristics before use.

Handling of this document and other requests

Please refer to the " Site Guidance" on our website for the handling of information contained in this document. (<https://www.ndk.com/en/terms/>)