

## 5A, 150V Trench Schottky Surface Mount Rectifier

### FEATURES

- AEC-Q101 qualified
- Excellent high temperature stability
- Low forward voltage
- Lower power loss/ high efficiency
- High forward surge capability
- Ideal for automated placement
- Moisture sensitivity level: level 1, per J-STD-020
- RoHS Compliant
- Halogen-free

### APPLICATIONS

- Switching mode power supply (SMPS)
- Adapters
- DC to DC converter

### MECHANICAL DATA

- Case: TO-277A (SMPC4.6U)
- Molding compound meets UL 94V-0 flammability rating
- Terminal: Matte tin plated leads, solderable per J-STD-002
- Meet JESD 201 class 2 whisker test
- Polarity: Indicated by cathode band
- Weight: 0.11g (approximately)

KEY PARAMETERS		
PARAMETER	VALUE	UNIT
$I_F$	5	A
$V_{RRM}$	150	V
$I_{FSM}$	125	A
$T_{J\ MAX}$	150	°C
Package	TO-277A (SMPC4.6U)	
Configuration	Single die	



**TO-277A (SMPC4.6U)**

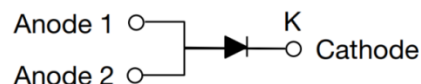

ABSOLUTE MAXIMUM RATINGS ( $T_A = 25^\circ\text{C}$ unless otherwise noted)			
PARAMETER	SYMBOL	VALUE	UNIT
Repetitive peak reverse voltage	$V_{RRM}$	150	V
Reverse voltage, total rms value	$V_{R(RMS)}$	105	V
Forward current	$I_F$	5	A
Peak forward surge current, 8.3ms single half sine-wave superimposed on rated load	$I_{FSM}$	125	A
Junction temperature	$T_J$	- 55 to +150	°C
Storage temperature	$T_{STG}$	- 55 to +150	°C

<b>THERMAL PERFORMANCE</b>			
<b>PARAMETER</b>	<b>SYMBOL</b>	<b>TYP</b>	<b>UNIT</b>
Junction-to-lead thermal resistance <sup>(1)</sup>	R <sub>θJL</sub>	2.2	°C/W
Junction-to-ambient thermal resistance <sup>(2)</sup>	R <sub>θJA</sub>	53.2	°C/W
Junction-to-case thermal resistance <sup>(2)</sup>	R <sub>θJC</sub>	11.8	°C/W

**Thermal Performance Notes:**

1. With ideal heat sink
2. Units mounted on PCB (16mm x 16mm Cu pad test board)

<b>ELECTRICAL SPECIFICATIONS</b> (T <sub>A</sub> = 25°C unless otherwise noted)					
<b>PARAMETER</b>	<b>CONDITIONS</b>	<b>SYMBOL</b>	<b>TYP</b>	<b>MAX</b>	<b>UNIT</b>
Forward voltage <sup>(1)</sup>	I <sub>F</sub> = 2.5A, T <sub>J</sub> = 25°C	V <sub>F</sub>	0.71	-	V
	I <sub>F</sub> = 5.0A, T <sub>J</sub> = 25°C		0.78	0.85	V
	I <sub>F</sub> = 2.5A, T <sub>J</sub> = 125°C		0.56	-	V
	I <sub>F</sub> = 5.0A, T <sub>J</sub> = 125°C		0.63	0.69	V
Reverse current @ rated V <sub>R</sub> <sup>(2)</sup>	T <sub>J</sub> = 25°C	I <sub>R</sub>	-	10	μA
	T <sub>J</sub> = 125°C		-	5	mA
Junction capacitance	1MHz, V <sub>R</sub> = 4.0V	C <sub>J</sub>	248	-	pF

**Notes:**

1. Pulse test with PW = 0.3ms
2. Pulse test with PW = 30ms

<b>ORDERING INFORMATION</b>		
<b>ORDERING CODE</b>	<b>PACKAGE</b>	<b>PACKING</b>
TSUP5150H	TO-277A (SMPC4.6U)	6,000 / Tape & Reel

**CHARACTERISTICS CURVES**

( $T_A = 25^\circ\text{C}$  unless otherwise noted)

**Fig.1 Forward Current Derating Curve**

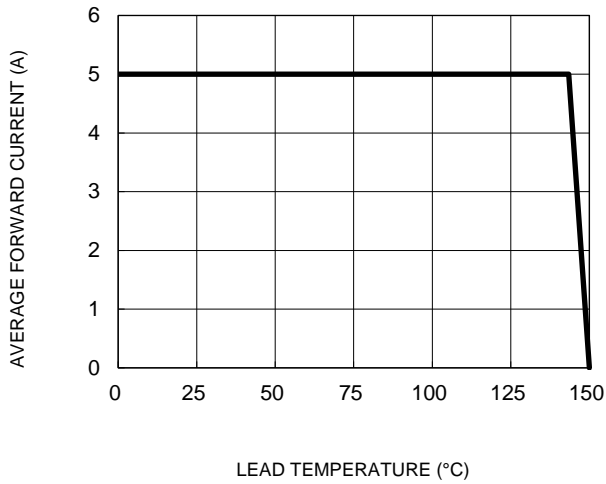

**Fig.2 Typical Junction Capacitance**

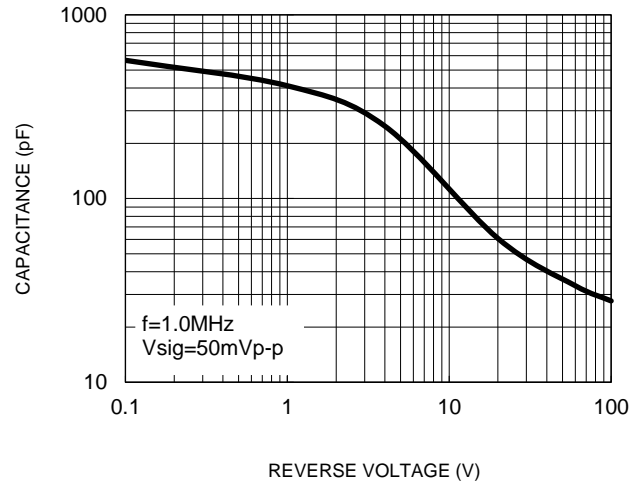

**Fig.3 Typical Reverse Characteristics**

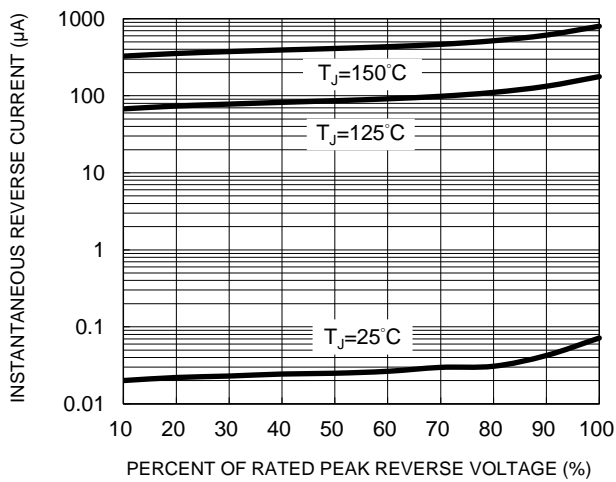

**Fig.4 Typical Forward Characteristics**

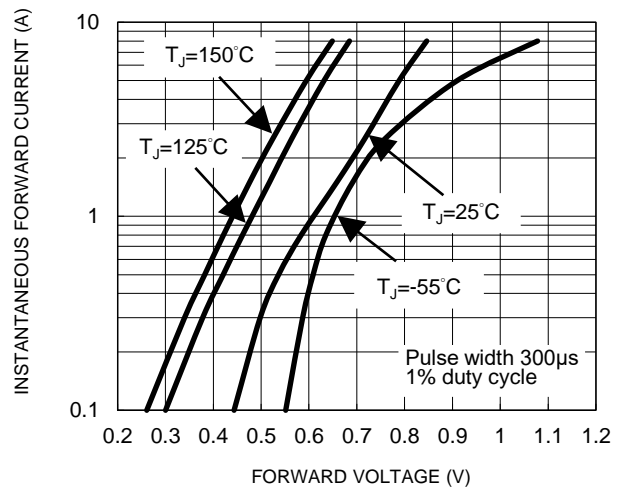

**Fig.5 Typical Forward Power Dissipation vs. Forward Current**

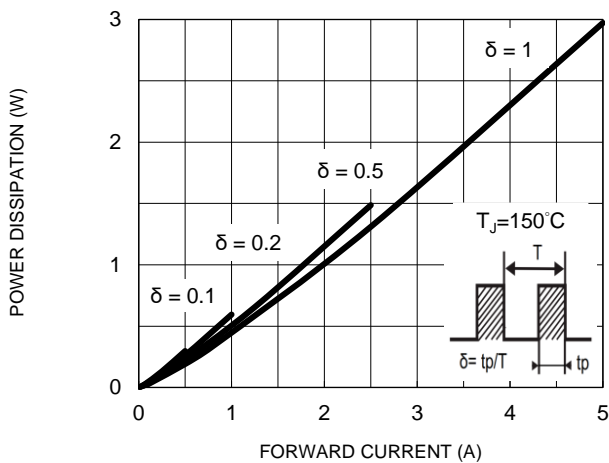

**CHARACTERISTICS CURVES**

(T<sub>A</sub> = 25°C unless otherwise noted)

**Fig.6 Typical Transient Thermal Characteristics**

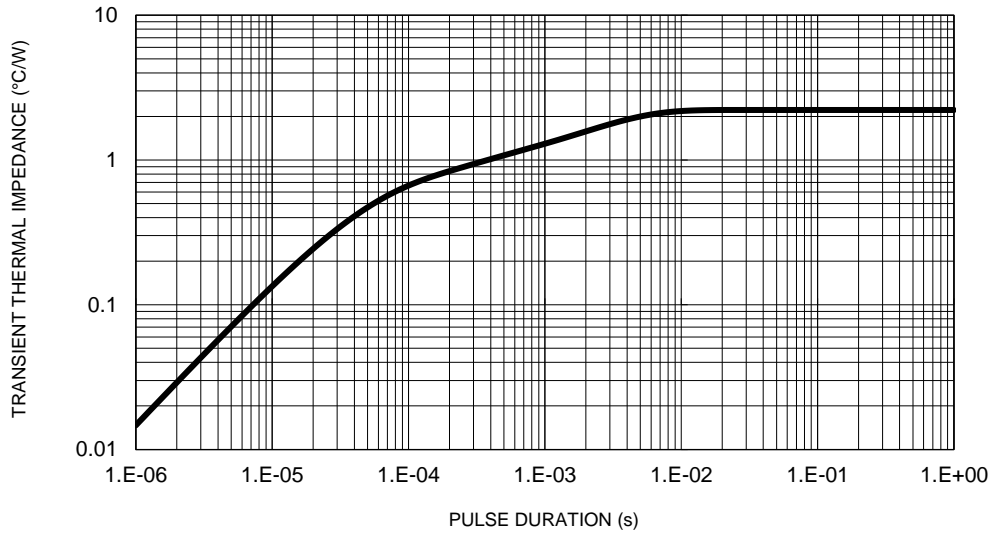

**PACKAGE OUTLINE DIMENSIONS**

**TO-277A(SMPC4.6U)**

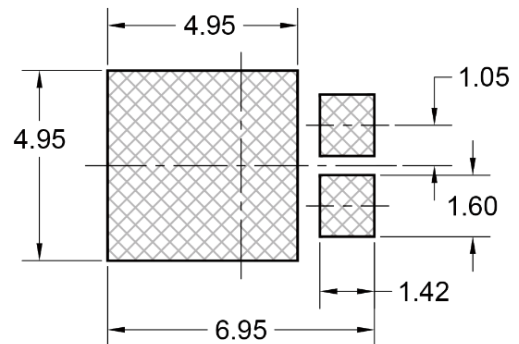
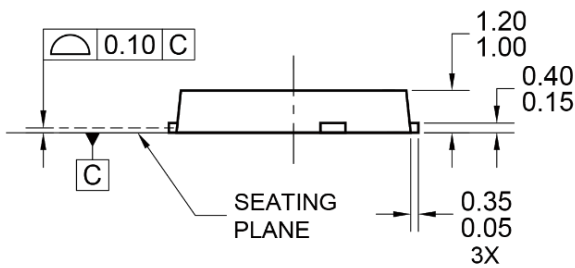
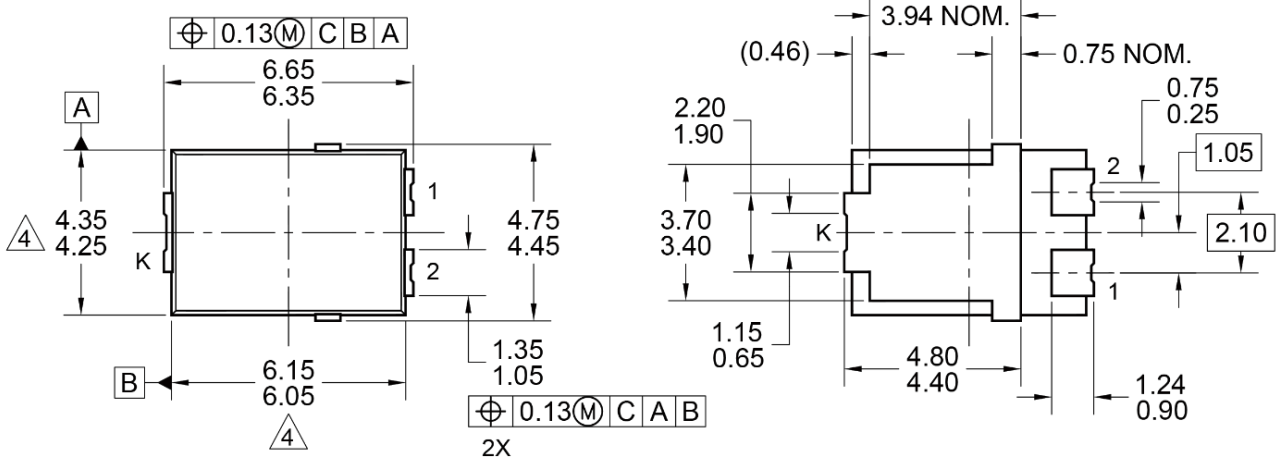

SUGGESTED PAD LAYOUT  
(REFERENCE ONLY)

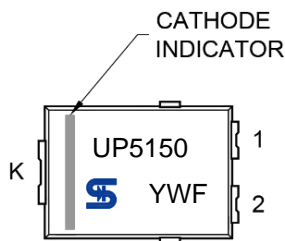

MARKING DIAGRAM

YW = Date code  
F = Factory code

NOTES: UNLESS OTHERWISE SPECIFIED

1. ALL DIMENSIONS ARE IN MILLIMETERS.
2. DIMENSIONING AND TOLERANCING PER ASME Y14.5M-1994.
3. PACKAGE OUTLINE REFERENCE: JEDEC TO-277 ISSUE A.
4. MOLDED PLASTIC BODY DIMENSIONS DO NOT INCLUDE MOLD LASH, PROTRUSIONS OR GATE BURRS.
5. DWG NO. REF: HQ2SD07-SMPC4.6U-031 REV A.

## **Notice**

Specifications of the products displayed herein are subject to change without notice. TSC or anyone on its behalf assumes no responsibility or liability for any errors or inaccuracies.

Purchasers are solely responsible for the choice, selection, and use of TSC products and TSC assumes no liability for application assistance or the design of Purchasers' products.

Information contained herein is intended to provide a product description only. No license, express or implied, to any intellectual property rights is granted by this document. Except as provided in TSC's terms and conditions of sale for such products, TSC assumes no liability whatsoever, and disclaims any express or implied warranty, relating to sale and/or use of TSC products including liability or warranties relating to fitness for a particular purpose, merchantability, or infringement of any patent, copyright, or other intellectual property right.

The products shown herein are not designed for use in medical, life-saving, or life-sustaining applications. Customers using or selling these products for use in such applications do so at their own risk and agree to fully indemnify TSC for any damages resulting from such improper use or sale.