

Common mode filters/Chokes

Automotive power line (for power train/safety)

ACM-V series



AEC-Q200

ACM55V type



FEATURES

- Exclusive square type closed magnetic core designed as an exclusive core is used, so it can be small while maintaining the same features.
- Low profile design makes it optimal for surface mounting.
- Excellent impedance characteristics, making it great for suppressing common mode noise.
- It can handle up to a maximum of 4.7A, including temperature derating.
- Operating temperature range: -40 to +125°C (Does not include self-heating.)
-40 to +155°C if self-heating is included.
- Compliant with AEC-Q200

APPLICATION

- Measures against common mode noise in power lines for various DC power lines, multimedia devices, and various electronic devices, including automotive power trains and safety applications.

PART NUMBER CONSTRUCTION

ACM	55V	-	701	-	2PL	-	TL	00
Series name	LxWxH dimensions 5.5x5.5x3.5 mm		Impedance (Ω) at 100MHz		Number of lines		Packaging style	Internal code

CHARACTERISTICS SPECIFICATION TABLE

Common mode impedance [at 100MHz]		DC resistance	Rated current Operating environment temperature			Rated voltage	Insulation resistance	Part No.
(Ω)min.	(Ω)typ.	(mΩ)max.	-40~85°C (A)max.	105°C (A)max.	125°C (A)max.	(V)max.	(MΩ)min.	
500	700	17	4.7	4.0	3.1	80	10	ACM55V-701-2PL-TL00

* Please refer to the derating curve for the rated current.

Derating

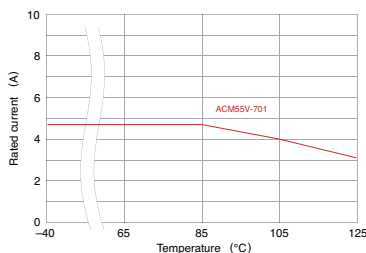

Measurement equipment

Measurement item	Product No. *	Manufacturer
Common mode impedance	4991B	Keysight Technologies
DC resistance	RM3545	HIOKI E.E. CORPORATION
Insulation resistance	4339B	Keysight Technologies

* Equivalent measurement equipment may be used.

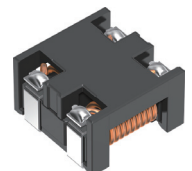

ACM55V type

■ IMPEDANCE VS. FREQUENCY CHARACTERISTICS

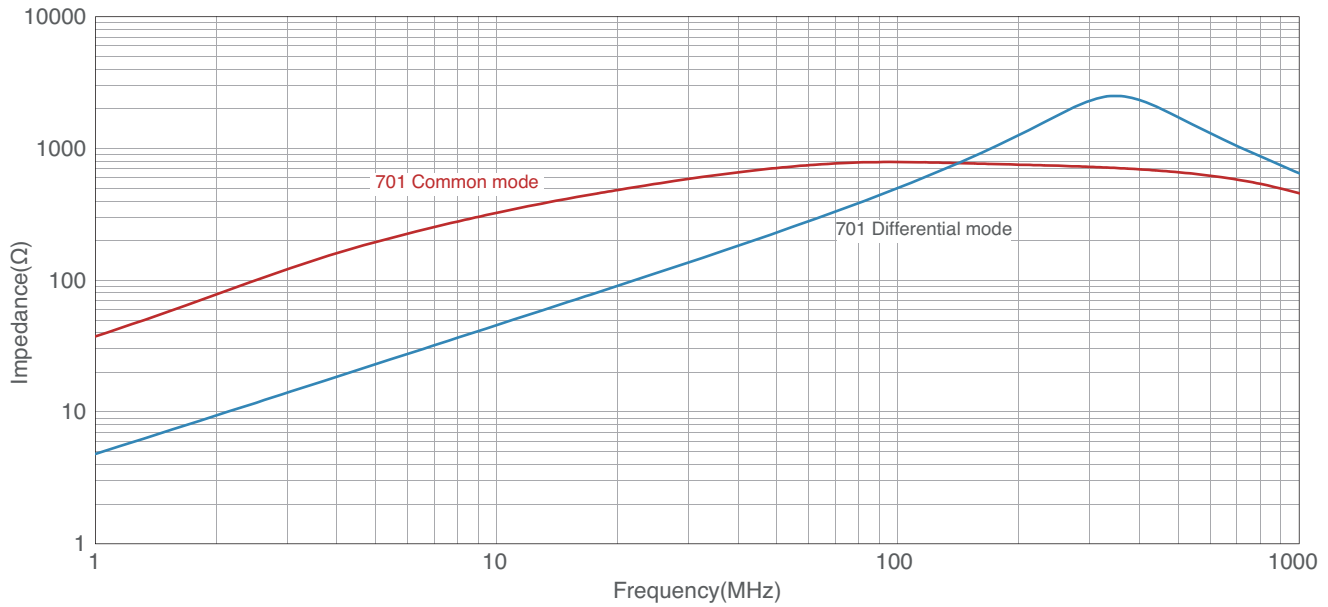

Measurement equipment

Product No. *	Manufacturer
4991B	Keysight Technologies

* Equivalent measurement equipment may be used.

■ TEMPERATURE RANGE, INDIVIDUAL WEIGHT

Operating temperature range *	Storage temperature range **	Individual weight
-40 to +125 °C	-40 to +125 °C	0.25 g

* The operating temperature range of this product does not include self-heating.
If self-heating is included, the product can be used at -40 to +155°C.

For use at 125°C, please use within the current range shown in the table on page (1/4) of this catalog.

**The storage temperature range is for after the assembly.

ACM55V type

SHAPE & DIMENSIONS

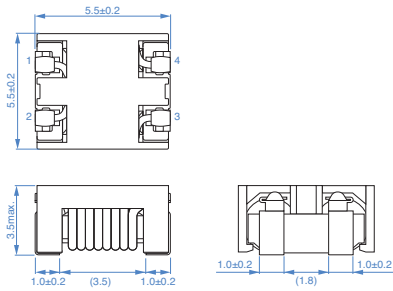

Dimensions in mm

RECOMMENDED LAND PATTERN

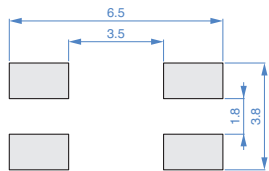

Dimensions in mm

CIRCUIT DIAGRAM

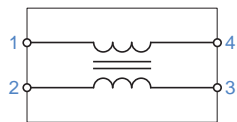

• No polarity

RECOMMENDED REFLOW PROFILE

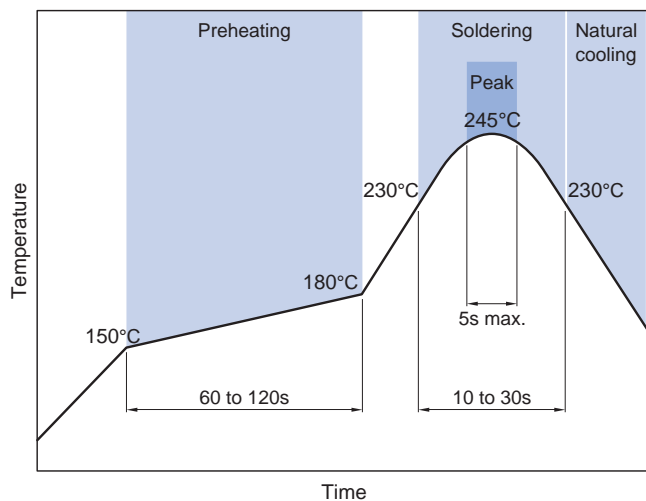

PACKAGING STYLE

REEL DIMENSIONS

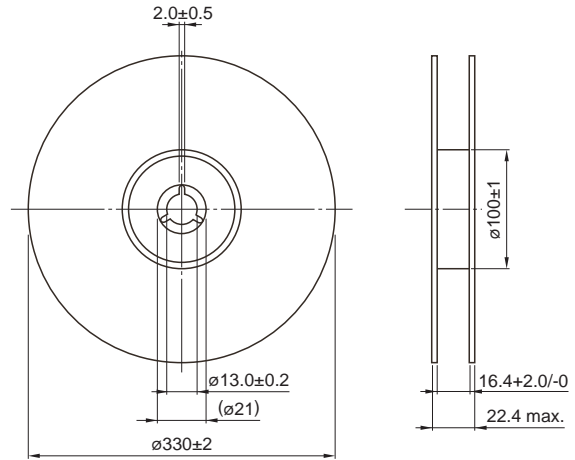

Dimensions in mm

TAPE DIMENSIONS

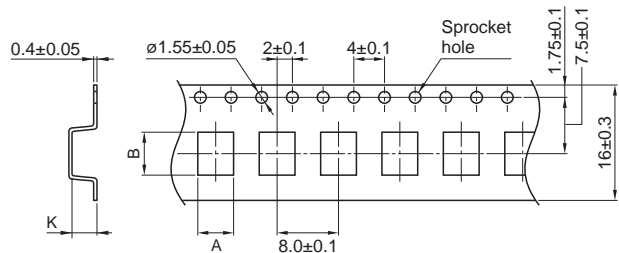

Dimensions in mm

Type	A	B	K
ACM55V	(5.9)	(5.9)	(3.7)

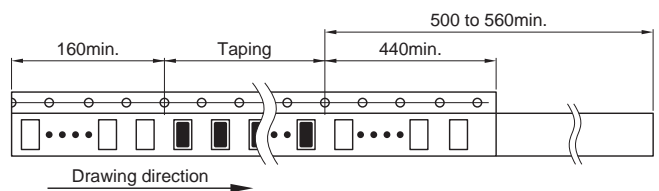

Dimensions in mm

PACKAGE QUANTITY

Package quantity	1,500 pcs/reel
------------------	----------------

REMINDERS FOR USING THESE PRODUCTS

Before using these products, be sure to request the delivery specifications.

SAFETY REMINDERS

Please pay sufficient attention to the warnings for safe designing when using this products

REMINDERS

- The storage period is within 12 months. Be sure to follow the storage conditions (temperature: 5 to 40°C, humidity: 10 to 75% RH or less).
If the storage period elapses, the soldering of the terminal electrodes may deteriorate.
- Do not use or store in locations where there are conditions such as gas corrosion (salt, acid, alkali, etc.).
- Soldering corrections after mounting should be within the range of the conditions determined in the specifications.
If overheated, a short circuit, performance deterioration, or lifespan shortening may occur.
- When embedding a printed circuit board where a chip is mounted to a set, be sure that residual stress is not given to the chip due to the overall distortion of the printed circuit board and partial distortion such as at screw tightening portions.
- Self heating (temperature increase) occurs when the power is turned ON, so the tolerance should be sufficient for the set thermal design.
- Carefully lay out the coil for the circuit board design of the non-magnetic shield type.
A malfunction may occur due to magnetic interference.
- Use a wrist band to discharge static electricity in your body through the grounding wire.
- Do not expose the products to magnets or magnetic fields.
- Do not use for a purpose outside of the contents regulated in the delivery specifications.
- The products described in this catalog are intended to be installed in automobiles or automotive electronic equipment (AV equipment, telecommunications equipment, home appliances, amusement equipment, computer equipment, personal equipment, office equipment, measurement equipment, industrial robots) and to be used in automobiles (including the case where the said automotive product is mounted in a vehicle) or standard applications as general electronic equipment in automotive applications or standard applications as general electronic equipment in automotive applications in accordance with the scope and conditions described in this specification, while the said automotive or general electronic equipment including the said product is intended to be used in the usual operation and usage methods, respectively. Other than automotive or automotive products are not designed or warranted to meet the requirements of the applications listed below, whose performance and/or quality requires a more stringent level of safety or reliability, or whose failure, malfunction or defect could cause serious damage to society, person or property.
Please understand that we are not responsible for any damage or liability caused by use of the products in any of the applications below or for any other use exceeding the range or conditions set forth in this specification sheet.
If you intend to use the products in the applications listed below or if you have special requirements exceeding the range or conditions set forth in this specification, please contact us.

- | | |
|---|--|
| (1) Aerospace/aviation equipment | (7) Transportation control equipment |
| (2) Transportation equipment (electric trains, ships, etc.) | (8) Public information-processing equipment |
| (3) Medical equipment | (9) Military equipment |
| (4) Power-generation control equipment | (10) Electric heating apparatus, burning equipment |
| (5) Atomic energy-related equipment | (11) Disaster prevention/crime prevention equipment |
| (6) Seabed equipment | (12) Safety equipment |
| | (13) Other applications that are not considered general-purpose applications |

When designing your equipment even for general-purpose applications, you are kindly requested to take into consideration securing protection circuit/device or providing backup circuits in your equipment.