

ESF21G-ESF28G SUPER FAST RECTIFIER

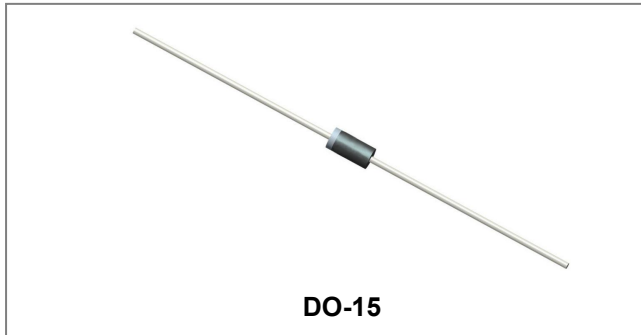

Features

- Super fast switching for high efficiency
- Low leakage current
- High forward surge capability
- Solder dip 260 ° C, 40 s
- Component in accordance to RoHS 2002/95/EC and WEEE 2002/96/EC
- This is a Pb – Free Device
- All SMC parts are traceable to the wafer lot
- Additional testing can be offered upon request

Circuit Diagram



Mechanical Data

- Case: JEDEC DO-15 molded plastic body
- Terminals: Plated axial leads, solderable per MIL-STD-750, Method 2026
- Polarity: Color band denotes cathode end
- Mounting Position: Any
- Weight: 0.014 ounce, 0.40 grams

Maximum Ratings and Electrical Characteristics @ $T_A=25^{\circ}\text{C}$ unless otherwise specified

Characteristic	Symbol	ESF 21G	ESF 22G	ESF 23G	ESF 24G	ESF 25G	ESF 26G	ESF 28G	Units
Maximum repetitive peak reverse voltage	V_{RRM}	50	100	150	200	300	400	600	V
Maximum RMS voltage	V_{RMS}	35	70	105	140	210	280	420	V
Maximum DC blocking voltage	V_{DC}	50	100	150	200	300	400	600	V
Maximum average forward rectified current 0.375"(9.5mm) lead length at $T_A=55^{\circ}\text{C}$	$I_{(AV)}$	2.0							A
Peak forward surge current 8.3ms single half sine-wave superimposed on rated load (JEDEC Method)	I_{FSM}	50							A
Maximum instantaneous forward voltage at 2.0A	V_F	0.95			1.25		1.7		V
Maximum DC reverse current $T_A=25^{\circ}\text{C}$ at rated DC blocking voltage $T_A=100^{\circ}\text{C}$	I_R	5.0			50.0				μA
Maximum Reverse Recovery Time (Note 1)	T_{rr}	35							ns
Typical Junction Capacitance (Note 2)	C_J	26.0			13.0				pF
Typical Thermal Resistance (Note 3)	$R_{\theta JA}$	50.0							$^{\circ}\text{C}/\text{W}$
Junction Temperature	T_J	-65 to +175							$^{\circ}\text{C}$
Storage Temperature Range	T_{STG}	-65 to +175							$^{\circ}\text{C}$

Note: 1. Reverse recovery condition $I_F=0.5\text{A}$, $I_R=1.0\text{A}$. $I_{rr}=0.25\text{A}$

2. Measured at 1MHz and applied reverse voltage of 4.0V D.C.

3. Thermal resistance from junction to ambient at 0.375"(9.5mm) lead length, P.C.B mounted.

- China - Germany - Korea - Singapore - United States •
- <http://www.smc-diodes.com> - sales@smc-diodes.com •

Ratings and Characteristics Curves

FIG. 1- FORWARD CURRENT DERATING CURVE

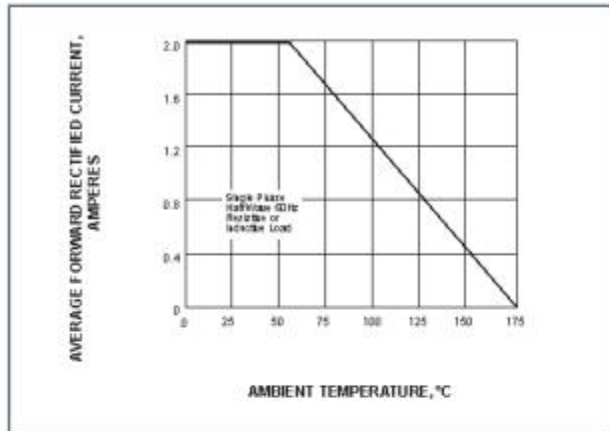

FIG. 2-MAXIMUM NON-REPETITIVE PEAK FORWARD SURGE CURRENT

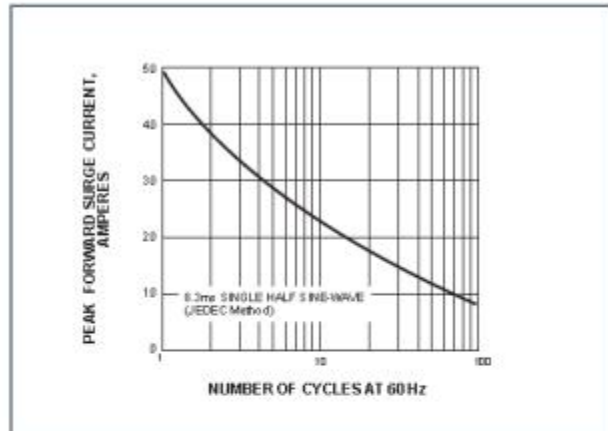

FIG. 3-TYPICAL INSTANTANEOUS FORWARD CHARACTERISTICS

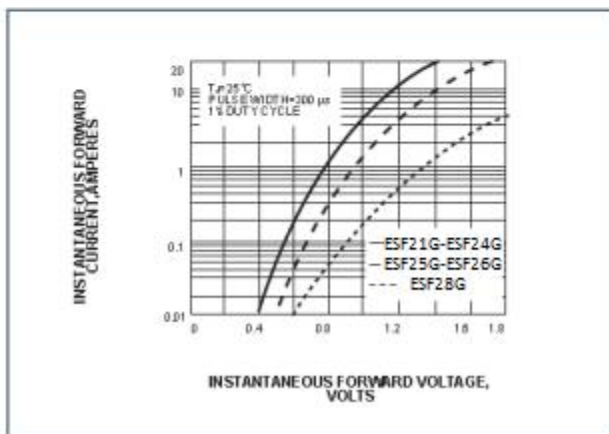

FIG. 4-TYPICAL REVERSE CHARACTERISTICS

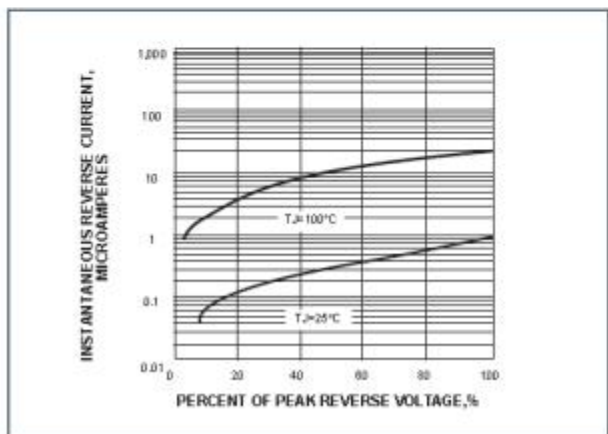
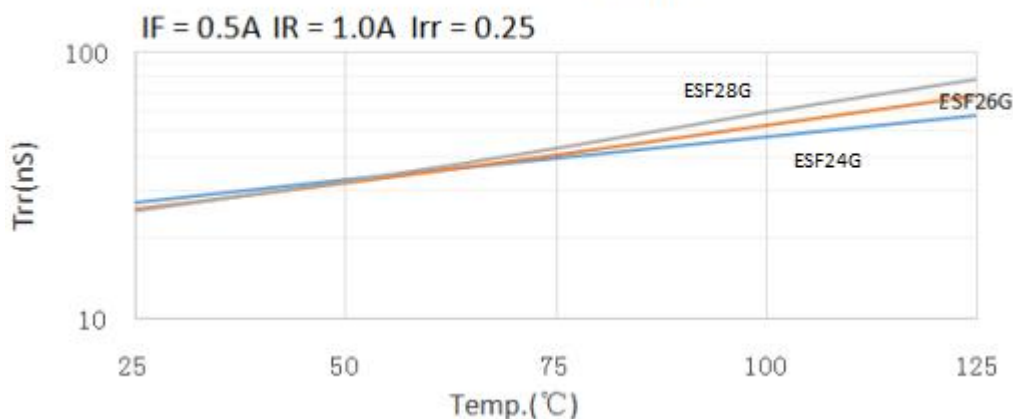
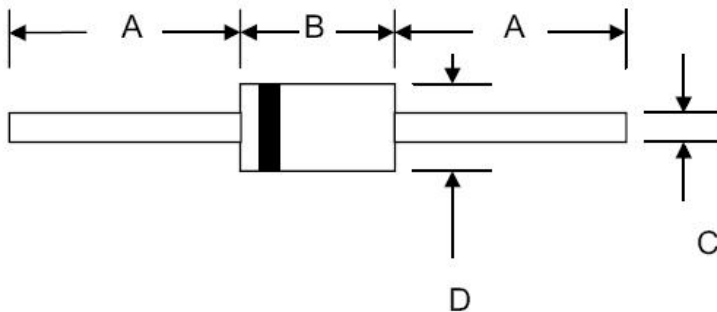

Fig.5 Trr & Temp.



Mechanical Dimensions DO-15



SYMBOL	Millimeters		Inches	
	Min.	Max.	Min.	Max.
A	25.4	-	1.000	-
B	5.5	7.62	0.217	0.300
C	0.7	0.9	0.028	0.034
D	2.6	3.6	0.104	0.140

Ordering Information

Device	Package	Shipping
ESF21G THRU ESF28G	DO-15 (Pb-Free)	3000pcs /tape

For information on tape and reel specifications, including part orientation and tape sizes, please refer to our tape and reel packaging specification.

Marking Diagram



Where XXXXX is YYWWL

ESF21G = Part Name
SSG = SSG
YY = Year
WW = Week
L = Lot Number

Cautions: Molding resin
Epoxy resin UL:94V-0

Carrier Tape Specification DO-15

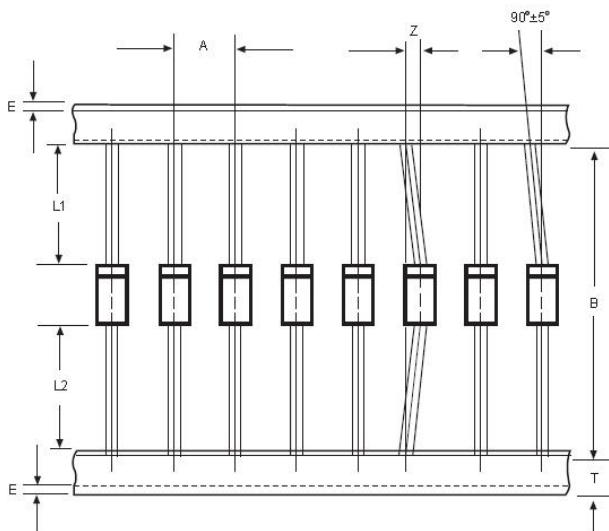

SYMBOL	Millimeters	
	Min.	Max.
A	4.50	5.50
B	50.9	53.9
Z	-	1.20
T	5.60	6.40
E	-	0.80
IL1-L2I	-	1.0

DISCLAIMER:

- 1- The information given herein, including the specifications and dimensions, is subject to change without prior notice to improve product characteristics. Before ordering, purchasers are advised to contact the SMC Diode Solutions sales department for the latest version of the datasheet(s).
- 2- In cases where extremely high reliability is required (such as use in nuclear power control, aerospace and aviation, traffic equipment, medical equipment, and safety equipment), safety should be ensured by using semiconductor devices that feature assured safety or by means of users' fail-safe precautions or other arrangement.
- 3- In no event shall SMC Diode Solutions be liable for any damages that may result from an accident or any other cause during operation of the user's units according to the datasheet(s). SMC Diode Solution assumes no responsibility for any intellectual property claims or any other problems that may result from applications of information, products or circuits described in the datasheets.
- 4- In no event shall SMC Diode Solutions be liable for any failure in a semiconductor device or any secondary damage resulting from use at a value exceeding the absolute maximum rating.
- 5- No license is granted by the datasheet(s) under any patents or other rights of any third party or SMC Diode Solutions.
- 6- The datasheet(s) may not be reproduced or duplicated, in any form, in whole or part, without the expressed written permission of SMC Diode Solutions.
- 7- The products (technologies) described in the datasheet(s) are not to be provided to any party whose purpose in their application will hinder maintenance of international peace and safety nor are they to be applied to that purpose by their direct purchasers or any third party. When exporting these products (technologies), the necessary procedures are to be taken in accordance with related laws and regulations..