

Data Sheet | Item Number: 2052-323

2-conductor miniature through terminal block; with operating slots; 2.5 mm²; Center terminal block without snap-in mounting foot, without mounting flange; side and center marking; with test port; Push-in CAGE CLAMP®; 2,50 mm²; red

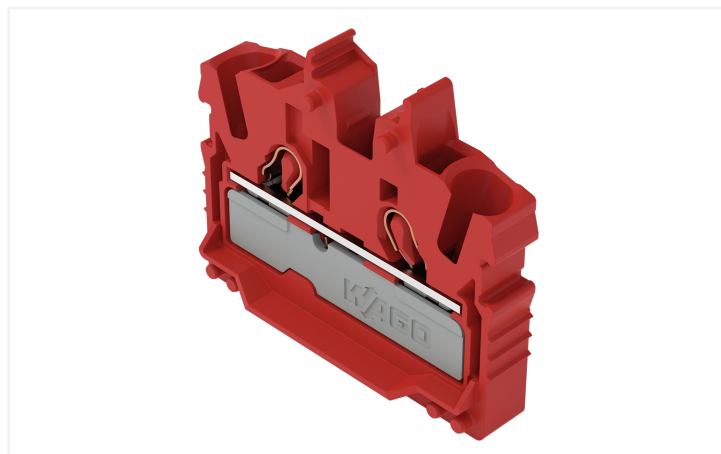

<https://www.wago.com/2052-323>

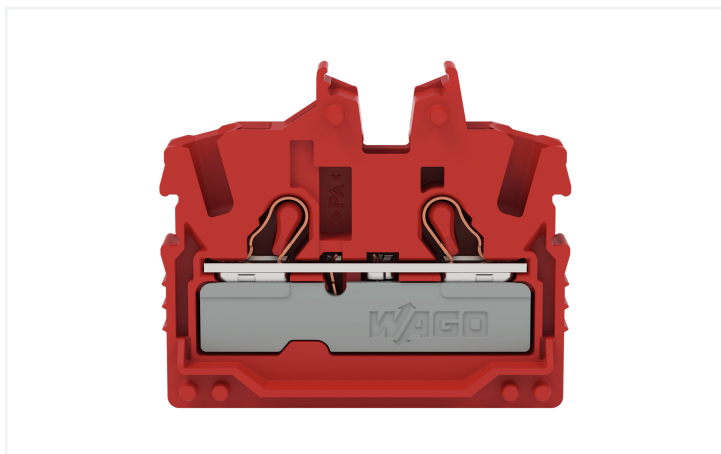

Color: ■ red

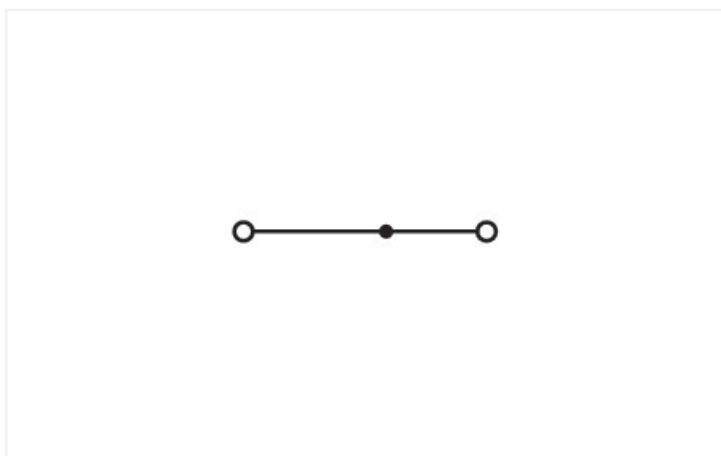

Similar to illustration

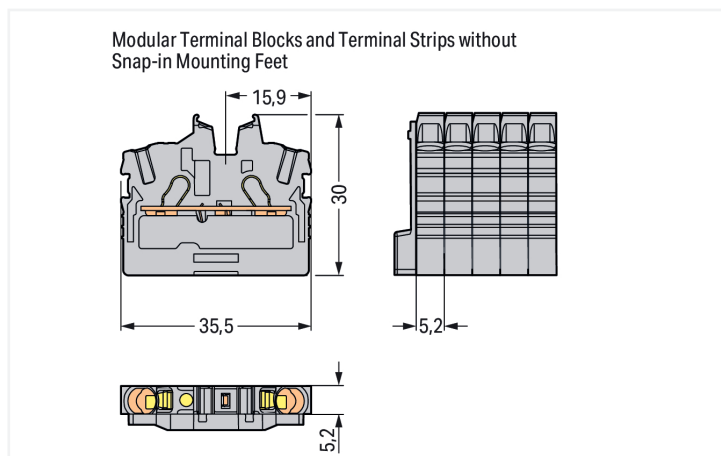

Through terminal block, 2052 Series, Push-in CAGE CLAMP®

Quick and easy connections are guaranteed with this through terminal block (item number 2052-323). Whether for use in industry or building installations, our rail-mount through terminal blocks make it easy to quickly and securely connect electrical conductors. They're perfect for either classic through-wiring or distributing potential, depending on the variant. Our mini rail-mount terminal block is rated for 800 V and is designed to handle a rated current of up to 24 A. Conductors can only be connected to this through terminal block if their strip length is between 10 mm and 12 mm. This product features conductor terminals and utilizes Push-in CAGE CLAMP®. Push-in CAGE CLAMP® technology provides a universal connection solution for all conductor types. It allows both solid and fine-stranded conductors with ferrules to be inserted directly into the clamping point without the need for tools. Depending on the type of conductor, this through terminal block is designed for conductor cross sections ranging from 0.25 mm² to 4 mm². It has one level. The single potential can connect using the two clamping points. The red housing is made of polyamide (PA66) for insulation. This mini rail-mount terminal block is operated with an operating tool. Our TOPJOB® S rail-mount terminal blocks are perfect for a wide range of industrial applications and modern building installations thanks to the secure electrical connections they provide. You can work anywhere in the world and on any application with just a single rail-mount terminal block system. Conductors made of copper can be connected via front-entry wiring. The one jumper slot enables potential distribution to other clamping points. This product is designed for specific Ex applications (please refer to the product datasheet).

Electrical data

| Ratings per | IEC/EN 60998-2-2 | | |
|---|------------------|-----|----|
| Overvoltage category | III | III | II |
| Pollution degree | 3 | 2 | 2 |
| Nominal voltage | 800 V | - | - |
| Rated impulse withstand voltage | 8 kV | - | - |
| Rated current | 24 A | - | - |
| Current at conductor cross-section (max.) mm ² | 32 A | - | - |

| Approvals per | UL 1059 | | |
|---------------|---------|-------|---|
| Use group | B | C | D |
| Rated voltage | 600 V | 600 V | - |
| Rated current | 20 A | 20 A | - |

| Approvals per | CSA 22.2 No 158 | | |
|---------------|-----------------|-------|---|
| Use group | B | C | D |
| Rated voltage | 600 V | 600 V | - |
| Rated current | 20 A | 20 A | - |

| Ex information | |
|-------------------------------------|---|
| Reference to hazardous areas | See "Downloads – Documentation – Additional Information: Technical Section; Technical Explanations" |
| Ratings per | ATEX: PTB 20 ATEX 1013 U / IECEx: PTB 20.0029U (Ex eb IIC Gb) |
| Rated voltage EN (Ex e II) | 550 V |
| Rated current (Ex e II) | 22 A |
| Rated current (Ex e II) with jumper | 20 A |

| Power Loss | |
|--|------------------|
| Power loss, per pole (potential) | 0.7661 W |
| Rated current I_N for power loss specification | 24 A |
| Resistance value for specified, current-dependent power loss | 0.00133 Ω |

Connection data

| | |
|----------------------------|---|
| Clamping units | 2 |
| Total number of potentials | 1 |
| Number of levels | 1 |
| Number of jumper slots | 1 |

| Connection 1 | |
|--|---|
| Connection technology | Push-in CAGE CLAMP® |
| Actuation type | Operating tool |
| Connectable conductor materials | Copper |
| Nominal cross-section | 2.5 mm ² |
| Solid conductor | 0.25 ... 4 mm ² / 22 ... 12 AWG |
| Solid conductor; push-in termination | 1 ... 4 mm ² / 18 ... 12 AWG |
| Fine-stranded conductor | 0.25 ... 4 mm ² / 22 ... 12 AWG |
| Fine-stranded conductor; with insulated ferrule | 0.25 ... 2.5 mm ² / 22 ... 14 AWG |
| Fine-stranded conductor; with ferrule; push-in termination | 1 ... 2.5 mm ² / 18 ... 14 AWG |
| Note (conductor cross-section) | Depending on the conductor characteristic, a conductor with a smaller cross-section can also be inserted via push-in termination. |
| Strip length | 10 ... 12 mm / 0.39 ... 0.47 inches |
| Wiring direction | Front-entry wiring |

Physical data

| | |
|-------------------------|------------------------|
| Width | 5.2 mm / 0.205 inches |
| Height from the surface | 30 mm / 1.181 inches |
| Depth | 35.5 mm / 1.398 inches |

Mechanical data

| | |
|---------------|-------------------------------|
| Mounting type | without snap-in mounting feet |
| Marking level | Center/side marking |

Material data

| | |
|------------------------------------|--|
| Note (material data) | Information on material specifications can be found here |
| Color | red |
| Material group | I |
| Insulation material (main housing) | Polyamide (PA66) |
| Flammability class per UL94 | V0 |
| Fire load | 0.085 MJ |
| Weight | 4 g |

Environmental requirements

| | |
|----------------------------------|-----------------|
| Processing temperature | -35 ... +85 °C |
| Continuous operating temperature | -60 ... +105 °C |

Commercial data

| | |
|-----------------------|---------------|
| PU (SPU) | 100 pcs |
| Packaging type | Box |
| Country of origin | IN |
| GTIN | 4066966312195 |
| Customs tariff number | 85369010000 |

Product Classification

| | |
|----------|----------------------|
| UNSPSC | 39121410 |
| ETIM 9.0 | EC001284 |
| ETIM 8.0 | EC001284 |
| ECCN | NO US CLASSIFICATION |

Environmental Product Compliance

| | |
|------------------------|-------------------------|
| RoHS Compliance Status | Compliant, No Exemption |
|------------------------|-------------------------|

Approvals / Certificates

Approvals for hazardous areas



| Approval | Standard | Certificate Name |
|---|-------------|--------------------|
| ATEX Physikalisch Technische Bundesanstalt | EN 60079 | PTB 20 ATEX 1013 U |
| CCC CQST/CNEx | GB/T 3836.1 | 2022312313000512 |
| IECEX Physikalisch Technische Bundesanstalt | IEC 60079 | IECEX PTB 20.0029U |
| INMETRO TÜV Rheinland do Brasil Ltda. | IEC 60079 | TÜV 22.0015 U |

Downloads

Environmental Product Compliance

Compliance Search

Environmental Product Compliance 2052-323



CAD/CAE-Data

CAD data

2D/3D Models
2052-323



1 Compatible Products

1.1 Required Accessories

1.1.1 End plate

1.1.1.1 End plate



[Item No.: 2052-381](#)
End plate; gray

1.2 Optional Accessories

1.2.1 Ferrule

1.2.1.1 Ferrule



[Item No.: 216-241](#)
Ferrule; Sleeve for 0.5 mm² / 20 AWG; insulated; electro-tin plated; electrolytic copper; gastight crimped; acc. to DIN 46228, Part 4/09.90; white



[Item No.: 216-242](#)
Ferrule; Sleeve for 0.75 mm² / 18 AWG; insulated; electro-tin plated; electrolytic copper; gastight crimped; acc. to DIN 46228, Part 4/09.90; gray



[Item No.: 216-262](#)
Ferrule; Sleeve for 0.75 mm² / 18 AWG; insulated; electro-tin plated; electrolytic copper; gastight crimped; acc. to DIN 46228, Part 4/09.90; gray



[Item No.: 216-243](#)
Ferrule; Sleeve for 1 mm² / AWG 18; insulated; electro-tin plated; electrolytic copper; gastight crimped; acc. to DIN 46228, Part 4/09.90; red



[Item No.: 216-263](#)
Ferrule; Sleeve for 1 mm² / AWG 18; insulated; electro-tin plated; electrolytic copper; gastight crimped; acc. to DIN 46228, Part 4/09.90; red



[Item No.: 216-244](#)
Ferrule; Sleeve for 1.5 mm² / AWG 16; insulated; electro-tin plated; electrolytic copper; gastight crimped; acc. to DIN 46228, Part 4/09.90; black



[Item No.: 216-264](#)
Ferrule; Sleeve for 1.5 mm² / AWG 16; insulated; electro-tin plated; electrolytic copper; gastight crimped; acc. to DIN 46228, Part 4/09.90; black



[Item No.: 216-246](#)
Ferrule; Sleeve for 2.5 mm² / AWG 14; insulated; electro-tin plated; electrolytic copper; gastight crimped; acc. to DIN 46228, Part 4/09.90; blue



[Item No.: 216-266](#)
Ferrule; Sleeve for 2.5 mm² / AWG 14; insulated; electro-tin plated; electrolytic copper; gastight crimped; acc. to DIN 46228, Part 4/09.90; blue

1.2.2 Insulation stop

1.2.2.1 Insulation stop



Item No.: [2002-171](#)

Insulation stop; 0.25 - 0.5 mm²; 5 pieces/strip; light gray



Item No.: [2002-172](#)

Insulation stop; 0.75 - 1 mm²; 5 pieces/strip; dark gray

1.2.3 Jumper

1.2.3.1 Jumper



Item No.: [2002-400](#)

Continuous jumper; 2-way; insulated; light gray



Item No.: [2002-413](#)

Continuous jumper; 3-way; insulated; light gray



Item No.: [2002-415](#)

Continuous jumper; 5-way; insulated; light gray



Item No.: [2002-423/000-006](#)

Continuous jumper; from 1 to 3; insulated; blue



Item No.: [2002-423](#)

Continuous jumper; from 1 to 3; insulated; light gray



Item No.: [2002-423/000-005](#)

Continuous jumper; from 1 to 3; insulated; red



Item No.: [2002-424/000-006](#)

Continuous jumper; from 1 to 4; insulated; blue



Item No.: [2002-424](#)

Continuous jumper; from 1 to 4; insulated; light gray



Item No.: [2002-424/000-005](#)

Continuous jumper; from 1 to 4; insulated; red



Item No.: [2002-406/020-000](#)

Delta jumper; insulated; light gray



Item No.: [2002-410/000-006](#)

Jumper; 10-way; insulated; blue



Item No.: [2002-410](#)

Jumper; 10-way; insulated; light gray



Item No.: [2002-410/000-005](#)

Jumper; 10-way; insulated; red



Item No.: [2002-402/000-006](#)

Jumper; 2-way; insulated; blue



Item No.: [2002-402](#)

Jumper; 2-way; insulated; light gray



Item No.: [2002-402/000-005](#)

Jumper; 2-way; insulated; red



Item No.: [2002-403/000-006](#)

Jumper; 3-way; insulated; blue



Item No.: [2002-403](#)

Jumper; 3-way; insulated; light gray



Item No.: [2002-403/000-005](#)

Jumper; 3-way; insulated; red



Item No.: [2002-404/000-006](#)

Jumper; 4-way; insulated; blue



Item No.: [2002-404](#)

Jumper; 4-way; insulated; light gray



Item No.: [2002-404/000-005](#)

Jumper; 4-way; insulated; red



Item No.: [2002-405/000-006](#)

Jumper; 5-way; insulated; blue



Item No.: [2002-405](#)

Jumper; 5-way; insulated; light gray



Item No.: [2002-405/000-005](#)

Jumper; 5-way; insulated; red



Item No.: [2002-406/000-006](#)

Jumper; 6-way; insulated; blue



Item No.: [2002-406](#)

Jumper; 6-way; insulated; light gray



Item No.: [2002-406/000-005](#)

Jumper; 6-way; insulated; red



Item No.: [2002-407/000-006](#)

Jumper; 7-way; insulated; blue



Item No.: [2002-407](#)

Jumper; 7-way; insulated; light gray



Item No.: [2002-407/000-005](#)

Jumper; 7-way; insulated; red



Item No.: [2002-408/000-006](#)

Jumper; 8-way; insulated; blue



Item No.: [2002-408](#)

Jumper; 8-way; insulated; light gray



Item No.: [2002-408/000-005](#)

Jumper; 8-way; insulated; red



Item No.: [2002-409/000-006](#)

Jumper; 9-way; insulated; blue



Item No.: [2002-409](#)

Jumper; 9-way; insulated; light gray



Item No.: [2002-409/000-005](#)

Jumper; 9-way; insulated; red



Item No.: [2002-440](#)

Jumper; from 1 to 10; insulated; light gray



Item No.: [2002-433](#)

Jumper; from 1 to 3; insulated; light gray



Item No.: [2002-434](#)

Jumper; from 1 to 4; insulated; light gray



Item No.: [2002-435](#)

Jumper; from 1 to 5; insulated; light gray



Item No.: [2002-436](#)

Jumper; from 1 to 6; insulated; light gray



Item No.: [2002-437](#)

Jumper; from 1 to 7; insulated; light gray



Item No.: [2002-438](#)



Jumper; from 1 to 8; insulated; light gray

1.2.3.1 Jumper





















| | | | |
|---|---|--|--|
|  Item No.: 2002-439 Jumper; from 1 to 9; insulated; light gray |  Item No.: 2002-480 Staggered jumper; 10-way; insulated; light gray |  Item No.: 2002-481 Staggered jumper; 11-way; insulated; light gray |  Item No.: 2002-482 Staggered jumper; 12-way; insulated; light gray |
|  Item No.: 2002-473/011-000 Staggered jumper; 2-way; from 1 to 3; insulated; light gray |  Item No.: 2002-472 Staggered jumper; 2-way; insulated; light gray |  Item No.: 2002-473 Staggered jumper; 3-way; insulated; light gray |  Item No.: 2002-475/011-000 Staggered jumper; 3-way; insulated; light gray |
|  Item No.: 2002-474 Staggered jumper; 4-way; insulated; light gray |  Item No.: 2002-475 Staggered jumper; 5-way; insulated; light gray |  Item No.: 2002-476 Staggered jumper; 6-way; insulated; light gray |  Item No.: 2002-477 Staggered jumper; 7-way; insulated; light gray |
|  Item No.: 2002-478 Staggered jumper; 8-way; insulated; light gray |  Item No.: 2002-479 Staggered jumper; 9-way; insulated; light gray |  Item No.: 2002-477/011-000 Staggered jumper; insulated; light gray |  Item No.: 2002-479/011-000 Staggered jumper; insulated; light gray |
|  Item No.: 2002-481/011-000 Staggered jumper; insulated; light gray |  Item No.: 2002-405/011-000 Star point jumper; 3-way; insulated; light gray |  Item No.: 210-103 Wire commoning chain; insulated; black |  Item No.: 210-123 Wire commoning chain; insulated; blue |

1.2.4 Marking

1.2.4.1 Group marker carrier

| | | |
|--|--|--|
|  Item No.: 2009-191 Group marker carrier; gray |  Item No.: 2009-192 Group marker carrier; gray |  Item No.: 2009-193 Group marker carrier; gray |
|--|--|--|

1.2.4.2 Marker

| | | | |
|--|--|--|--|
|  Item No.: 2009-145/000-006 Mini-WSB Inline; for Smart Printer; 1700 pieces on roll; stretchable 5 - 5.2 mm; plain; snap-on type; blue |  Item No.: 2009-145/000-007 Mini-WSB Inline; for Smart Printer; 1700 pieces on roll; stretchable 5 - 5.2 mm; plain; snap-on type; gray |  Item No.: 2009-145/000-023 Mini-WSB Inline; for Smart Printer; 1700 pieces on roll; stretchable 5 - 5.2 mm; plain; snap-on type; green |  Item No.: 2009-145/000-012 Mini-WSB Inline; for Smart Printer; 1700 pieces on roll; stretchable 5 - 5.2 mm; plain; snap-on type; orange |
|  Item No.: 2009-145/000-005 Mini-WSB Inline; for Smart Printer; 1700 pieces on roll; stretchable 5 - 5.2 mm; plain; snap-on type; red |  Item No.: 2009-145/000-024 Mini-WSB Inline; for Smart Printer; 1700 pieces on roll; stretchable 5 - 5.2 mm; plain; snap-on type; violet |  Item No.: 2009-145 Mini-WSB Inline; for Smart Printer; 1700 pieces on roll; stretchable 5 - 5.2 mm; plain; snap-on type; white |  Item No.: 2009-145/000-002 Mini-WSB Inline; for Smart Printer; 1700 pieces on roll; stretchable 5 - 5.2 mm; plain; snap-on type; yellow |
|  Item No.: 248-501/000-006 Mini-WSB marking card; as card; not stretchable; plain; snap-on type; blue |  Item No.: 248-501/000-007 Mini-WSB marking card; as card; not stretchable; plain; snap-on type; gray |  Item No.: 248-501/000-023 Mini-WSB marking card; as card; not stretchable; plain; snap-on type; green |  Item No.: 248-501/000-017 Mini-WSB marking card; as card; not stretchable; plain; snap-on type; light green |
|  Item No.: 248-501/000-012 Mini-WSB marking card; as card; not stretchable; plain; snap-on type; orange |  Item No.: 248-501/000-005 Mini-WSB marking card; as card; not stretchable; plain; snap-on type; red |  Item No.: 248-501/000-024 Mini-WSB marking card; as card; not stretchable; plain; snap-on type; violet |  Item No.: 248-501 Mini-WSB marking card; as card; not stretchable; plain; snap-on type; white |
|  Item No.: 248-501/000-002 Mini-WSB marking card; as card; not stretchable; plain; snap-on type; yellow |  Item No.: 793-5501/000-006 WMB marking card; as card; for terminal block width 5 - 17.5 mm; stretchable 5 - 5.2 mm; plain; snap-on type; blue |  Item No.: 793-5501/000-014 WMB marking card; as card; for terminal block width 5 - 17.5 mm; stretchable 5 - 5.2 mm; plain; snap-on type; brown |  Item No.: 793-5501/000-007 WMB marking card; as card; for terminal block width 5 - 17.5 mm; stretchable 5 - 5.2 mm; plain; snap-on type; gray |

1.2.4.2 Marker



Item No.: 793-5501/000-023
WMB marking card; as card; for terminal block width 5 - 17.5 mm; stretchable 5 - 5.2 mm; plain; snap-on type; green



Item No.: 793-5501/000-017
WMB marking card; as card; for terminal block width 5 - 17.5 mm; stretchable 5 - 5.2 mm; plain; snap-on type; light green



Item No.: 793-5501/000-012
WMB marking card; as card; for terminal block width 5 - 17.5 mm; stretchable 5 - 5.2 mm; plain; snap-on type; orange



Item No.: 793-5501/000-005
WMB marking card; as card; for terminal block width 5 - 17.5 mm; stretchable 5 - 5.2 mm; plain; snap-on type; red



Item No.: 793-5501/000-024
WMB marking card; as card; for terminal block width 5 - 17.5 mm; stretchable 5 - 5.2 mm; plain; snap-on type; violet



Item No.: 793-5501
WMB marking card; as card; for terminal block width 5 - 17.5 mm; stretchable 5 - 5.2 mm; plain; snap-on type; white



Item No.: 793-5501/000-002
WMB marking card; as card; for terminal block width 5 - 17.5 mm; stretchable 5 - 5.2 mm; plain; snap-on type; yellow



Item No.: 2009-115/000-006
WMB-Inline; for Smart Printer; 1500 pieces on roll; stretchable 5 - 5.2 mm; plain; snap-on type; blue



Item No.: 2009-115/000-007
WMB-Inline; for Smart Printer; 1500 pieces on roll; stretchable 5 - 5.2 mm; plain; snap-on type; gray



Item No.: 2009-115/000-023
WMB-Inline; for Smart Printer; 1500 pieces on roll; stretchable 5 - 5.2 mm; plain; snap-on type; green



Item No.: 2009-115/000-017
WMB-Inline; for Smart Printer; 1500 pieces on roll; stretchable 5 - 5.2 mm; plain; snap-on type; light green



Item No.: 2009-115/000-012
WMB-Inline; for Smart Printer; 1500 pieces on roll; stretchable 5 - 5.2 mm; plain; snap-on type; orange



Item No.: 2009-115/000-005
WMB-Inline; for Smart Printer; 1500 pieces on roll; stretchable 5 - 5.2 mm; plain; snap-on type; red



Item No.: 2009-115/000-024
WMB-Inline; for Smart Printer; 1500 pieces on roll; stretchable 5 - 5.2 mm; plain; snap-on type; violet



Item No.: 2009-115
WMB-Inline; for Smart Printer; 1500 pieces on roll; stretchable 5 - 5.2 mm; plain; snap-on type; white



Item No.: 2009-115/000-002
WMB-Inline; for Smart Printer; 1500 pieces on roll; stretchable 5 - 5.2 mm; plain; snap-on type; yellow

1.2.4.3 Marker carrier



Item No.: 2002-161
Adaptor; gray



Item No.: 2009-198
Adaptor; gray

1.2.4.4 Marking strip



Item No.: 2009-110
Marking strips; for Smart Printer; on reel; not stretchable; plain; snap-on type; white

1.2.5 Protective warning marker

1.2.5.1 Cover



Item No.: 2002-115
Protective warning marker; for 5 terminal blocks; with high-voltage symbol, black; yellow

1.2.6 Push-in type wire jumper

1.2.6.1 Jumper



Item No.: 2009-414

Push-in type wire jumper; 1.5 mm²; insulated; 110 mm long; black



Item No.: 2009-414/000-005

Push-in type wire jumper; 1.5 mm²; insulated; 110 mm long; black



Item No.: 2009-416

Push-in type wire jumper; 1.5 mm²; insulated; 250 mm long; black



Item No.: 2009-414/000-006

Push-in type wire jumper; insulated; 110 mm long; black



Item No.: 2009-412

Push-in type wire jumper; insulated; 60 mm long; black

1.2.7 Test and measurement

1.2.7.1 Testing accessories



Item No.: 2009-174

Test plug adapter; for 4 mm Ø test plugs; for testing TOPJOB®S rail-mounted terminal blocks; gray



Item No.: 210-136

Test plug; 2 mm Ø; with 500 mm cable; red



Item No.: 2009-182

Testing tap; for max. 2.5 mm²; tool-free connection for individual test wires 0.08 - 2.5 mm; gray



Item No.: 2002-649

TOPJOB®S L-type spacer module; modular; e.g., for bridging commoned terminal blocks; gray



Item No.: 2002-611

TOPJOB®S L-type test plug module; modular; 1-pole; gray

1.2.8 Tool

1.2.8.1 Operating tool



Item No.: 210-658

Operating tool; Blade: 3.5 x 0.5 mm; with a partially insulated shaft; angled; short; multicoloured



Item No.: 210-720

Operating tool; Blade: 3.5 x 0.5 mm; with a partially insulated shaft; multicoloured

Installation Notes

Installation

Example of a 4-pole terminal strip; with operating slot; with mounting flange

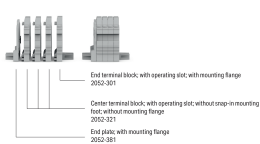

Example of a 2-pole terminal strip; with operating slot; with snap-in mounting foot
Pole number = 2

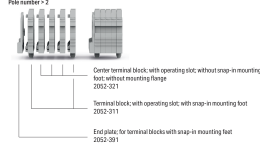

Conductor termination

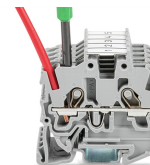
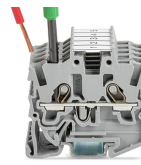

Insert solid conductors via push-in termination.

Insert ferruled conductors via push-in termination.

Insert fine-stranded conductors via operating tool.

Remove all conductors via operating tool.

Commoning

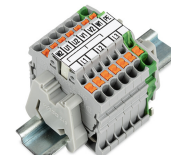
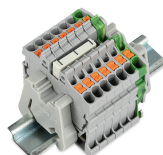
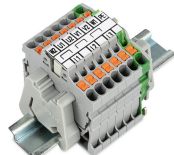

Insert a delta jumper and push down until it hits the backstop (example shows terminal blocks with push-buttons).

Marking strip (2009-110) inserted in the marking slot with jumper symbols of the inserted jumper (delta jumper) (example shows terminal blocks with push-buttons)

Insert a star point jumper and push down until it hits the backstop (example shows terminal blocks with push-buttons).

Marking strip (2009-110) inserted in the marking slot with jumper symbols of the inserted jumper (2000-405/011-000 Delta Jumper) (example shows terminal blocks with push-buttons)

Testing



Testing with a 2 mm Ø 210-136 Test Plug (max. 42 V).

Installation

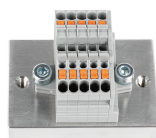
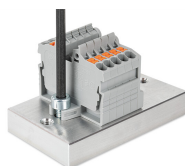

Installation

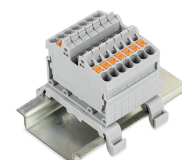
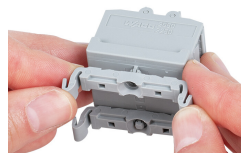

Marking



Snapping a marking strip into the marker slot.



Snapping a marking strip (2009-110) into a marker slot.