



Descriptions

The SN74LVC1G3157DCKR is a single SPDT low on-resistance analog switch. It can operate from a single 1.5V to 5.5V power supply. The device offers low ON-state resistance and excellent ON-state resistance matching with break-before-make feature, to prevent signal distortion during the transferring of a signal from one channel to another. The device is capable of truly isolation. Even when A overrides VCC, very little current will flow back to the supply.

Order Information

Package		Part Number	Quantity per Reel	Top-Side Marking
SOT-363	Tape and Reel	SN74LVC1G3157DCKR	3,000PCS	A57

Features

- Low On-resistance, $R_{on}=1.5\Omega$ when $A=5V$
- 1.8V Logic Compatible Control Pin
- A Overrides VCC to Achieve True Isolation Even When Supply Is Dead
- High Off-Isolation: $-100dB @ 100KHz$
- Low Channel-to-Channel Crosstalk: $-97dB @ 100KHz$
- High Bandwidth ($-3dB @ 700MHz$) Suitable for USB2.0 High-Speed Routing
- Low Quiescent Current ($<2\mu A$) With Very Wide Supply Range (1.5V ~ 5.5V)
- ESD HBM: $\pm 5500V$

Applications

- Audio, Video, UART, USB2.0 Signal and Supply Routing
- Cell phones and TWS headset

Pin Configuration

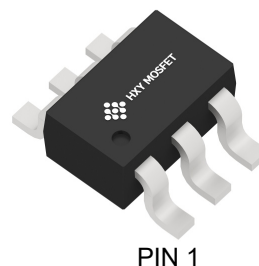
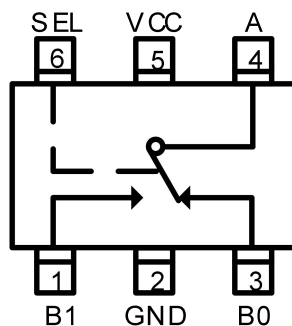

Pin configuration (Top view)
SOT-363



Functions and Pin Configuration

Pin Number	Symbol	Descriptions
1	B1	Analog/Digital Signal Port (Normally open)
2	GND	Ground
3	B0	Analog/Digital Signal Port (Normally closed)
4	A	Common Signal Port
5	VCC	Single Power Supply
6	SEL	Logic Input Control

Function Descriptions

Logic Input	Function
S=0	B0=A
S=1	B1=A

Absolute Maximum Ratings ⁽¹⁾

Parameter	Symbol	Value	Unit
Supply Voltage	V _{CC}	-0.3 ~ 6.5	V
Control Input Voltage	V _S	-0.3 ~ 6.5	V
Continuous Current Through A, B0, B1		±100	mA
Peak Current Through A, B0, B1 (pulsed at 1ms 50% duty cycle)		±200	mA
Storage Temperature Range	T _{STG}	-55 ~ 150	°C
Junction Temperature under Bias	T _J	150	°C
Lead Temperature (Soldering, 10 seconds)	T _L	260	°C
Thermal resistance	R _{θJA}	350	°C/W

Recommend operating ratings ⁽²⁾

Parameter	Symbol	Value	Unit
Supply Voltage Operating	V _{CC}	1.5 ~ 5.5	V
Control Input Voltage	V _S	-0.3 ~ 5.5	V
Input Signal Voltage	V _A	-0.3 ~ 5.5	V
Operating Temperature	T _A	-40 ~ 85	°C

Note:

1. "Absolute Maximum Ratings" may cause permanent damage to the device. This is a stress only rating and operation of the device at these or any other conditions beyond those indicated in the operational sections of this specification is not implied.



DC Electronics Characteristics (Ta=25°C, VCC=3.3V, unless otherwise noted)

Parameter	Symbol	Conditions	Min.	Typ.	Max.	Unit
Input logic high level	V _{IH}	VCC: 3.3 ~ 5.5V	1.6			V
		VCC: 1.5 ~ 3.3V	1.4			V
Input logic low level	V _{IL}	VCC: 3.3 ~ 5.5V			0.6	V
		VCC: 1.5 ~ 3.3V			0.4	V
Supply quiescent current	I _{CC}	I _A =0, V _S =0 or V _S =VCC			1.0	uA
Increase in I _{CC} per input	I _{CCT}	I _A =0, VCC=4.5V V _S >1.8 or V _S <0.5			1.0	uA
Off state leakage from A to B0 (or B1)	I _A	V _A = 5.5V , V _{B0(or B1)} = 0V			±2.0	uA
On-Resistance	R _{ON1}	V _A =0 ~ 0.5V, I _A =30mA		3.0	3.5	Ω
	R _{ON2}	V _A =0.5 ~ 2.0V, I _A =30mA		3.6	3.9	Ω
	R _{ON3}	V _A =2.0 ~ 4.0V, I _A =30mA		2.5	3.5	Ω
	R _{ON4}	V _A =4.0 ~ 5.5V, I _A =30mA		1.5	1.8	Ω
On-Resistance Flatness	R _{FLAT1}	V _A =0 ~ 0.5V, I _A =30mA		0.7		Ω
	R _{FLAT2}	V _A =0.5 ~ 2.0V, I _A =30mA		0.5		Ω
	R _{FLAT3}	V _A =2.0 ~ 4.0V, I _A =30mA		1.6		Ω
	R _{FLAT4}	V _A =4.0 ~ 5.5V, I _A =30mA		0.3		Ω
On-Resistance Matching Between Channels	Δ R _{ON}	V _A =0~5.5V, I _A =30mA,		0.1	0.2	Ω

AC Electronics Characteristics (Ta=25°C, VCC=3.3V, unless otherwise noted)

Parameter	Symbol	Conditions	Min.	Typ.	Max.	Unit
Turn-On Time	T _{ON}	V _A =1.5V, C _L =35pF, R _L =50Ω		200		ns
Turn-Off Time	T _{OFF}	V _A =1.5V, C _L =35pF, R _L =50Ω		200		ns
Break-Before-Make time	T _{BBM}	V _A =1.5V, C _L =35pF, R _L =50Ω		500		ns
-3dB Bandwidth	BW	R _L =50Ω, C _L =0pF		700		MHz
Off isolation	OIRR	F=1KHz, R _L =50Ω		-81		dB
		F=10KHz, R _L =50Ω		-80		dB
Crosstalk	Xtalk	F=1KHz, R _L =50Ω		-83		dB
		F=10KHz, R _L =50Ω		-82		dB
Total Harmonic Distortion	THD	F=20Hz to 20KHz V _A =600mVp-p @R _L =32Ω,		-80		dB

Capacitance (Ta=25°C unless otherwise noted)

Parameter	Symbol	Conditions	Min.	Typ.	Max.	Unit
Off capacitance	C _{OFF}	F=100KHz, VCC=3.3		5		pF
On capacitance	C _{ON}	F=100KHz, VCC=3.3		7		pF



Typical Characteristics (Ta=25°C, VCC=3.3V, unless otherwise noted)

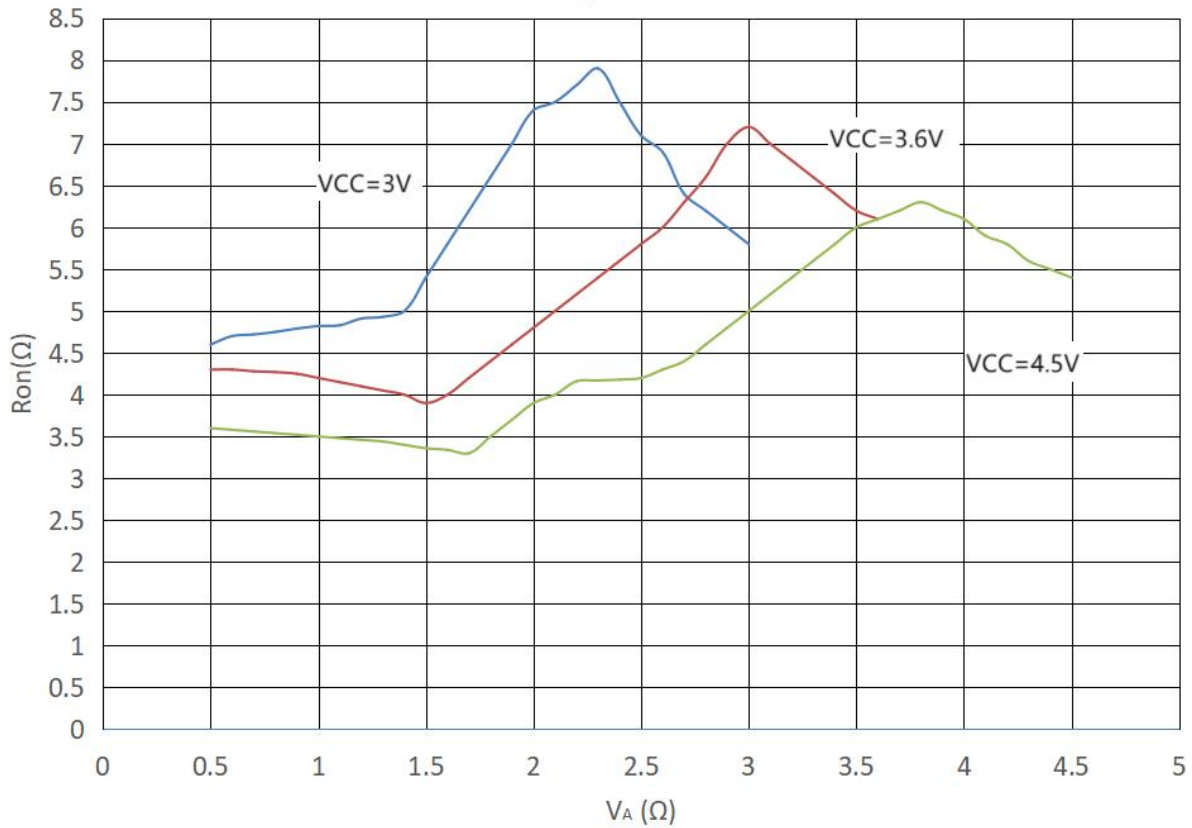

Ron vs. VCC and VA voltage

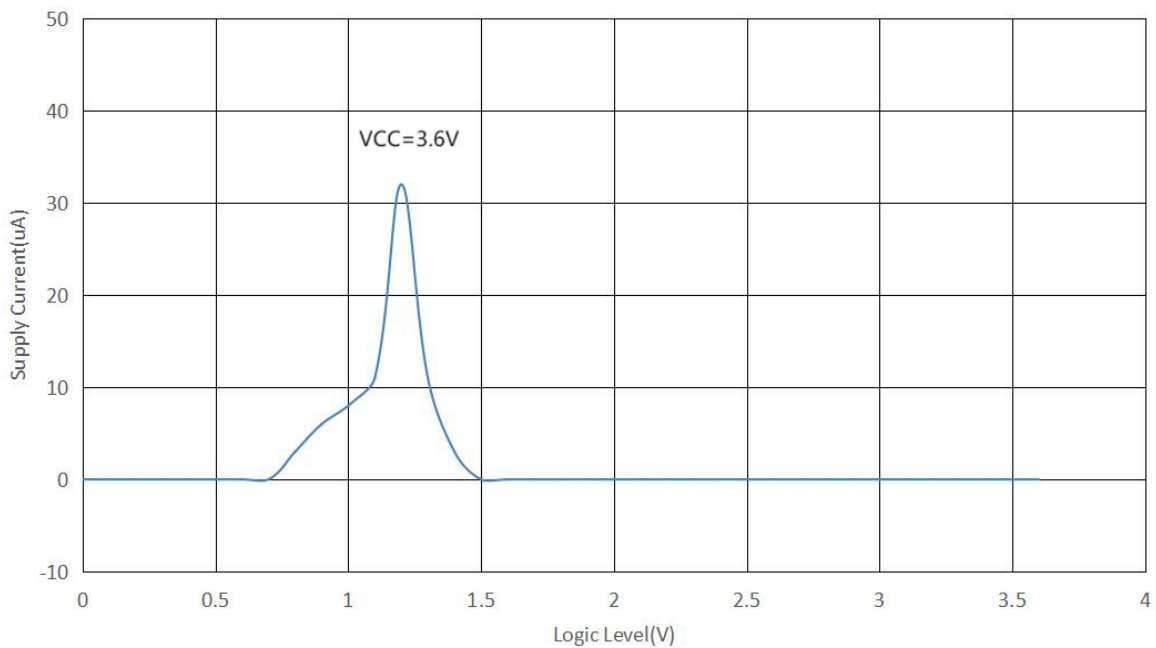

Supply Current vs. Logic Input

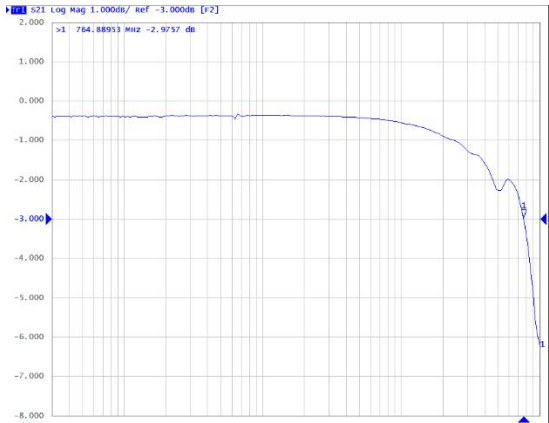

Insertion Loss (-3dB Bandwidth)

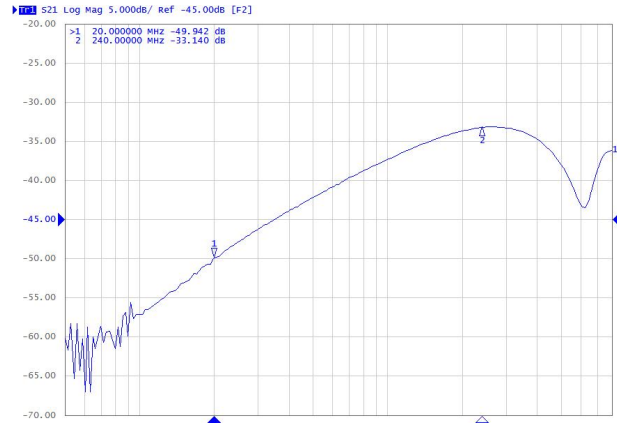

Off Isolation

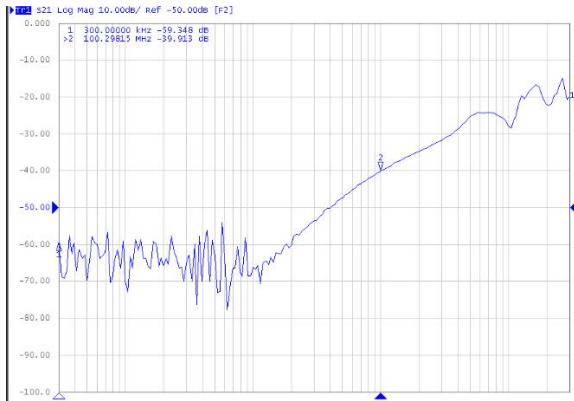

Cross-talk

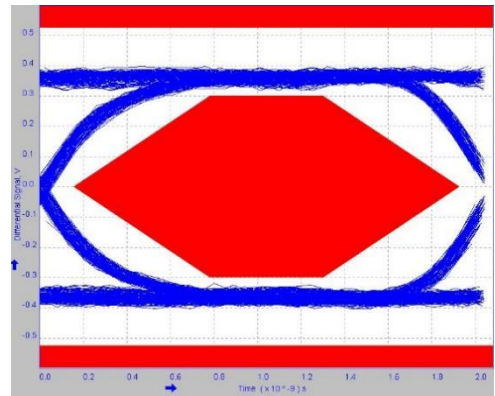

Eye Diagram (480Mbps)



Package Outline Dimensions

SOT-363(MicroPak-6)

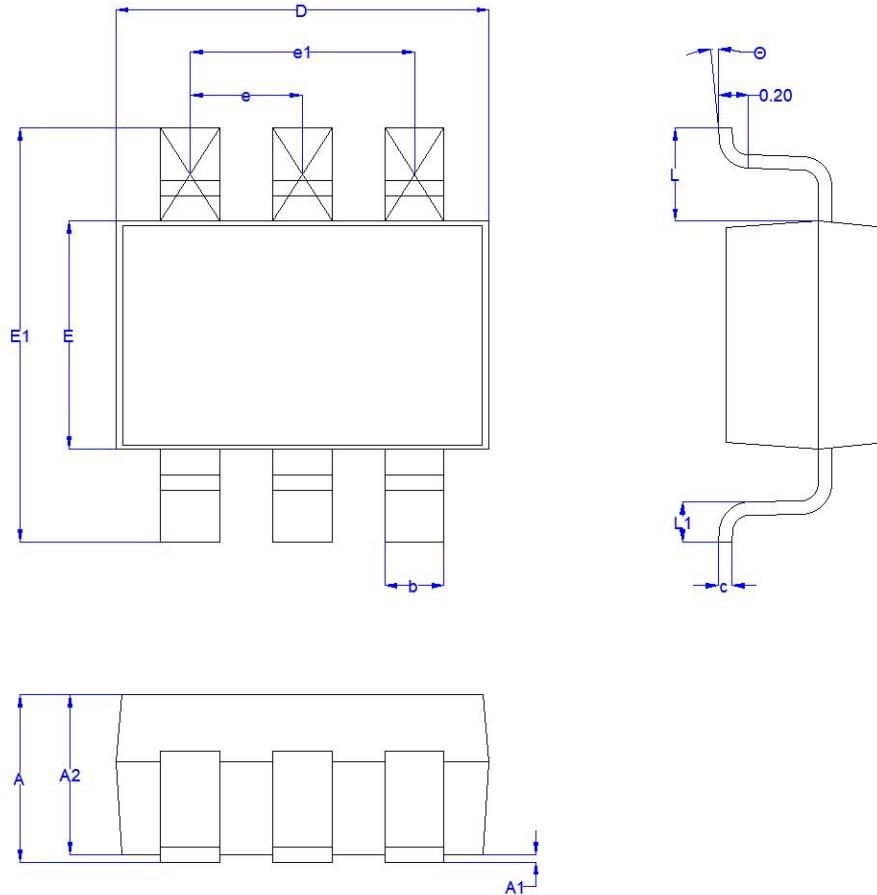

Symbol	Dimensions In Millimeters	
	Min.	Max.
A	0.900	1.100
A1	0.000	0.100
A2	0.900	1.000
b	0.150	0.350
c	0.080	0.150
D	2.000	2.200
E	1.150	1.350
E1	2.150	2.450
e	0.650Typ	
e1	1.300BSC	
L	0.525REF	
L1	0.260	0.460
Θ	0°	8°



Tape And Reel Information

Reel Dimensions

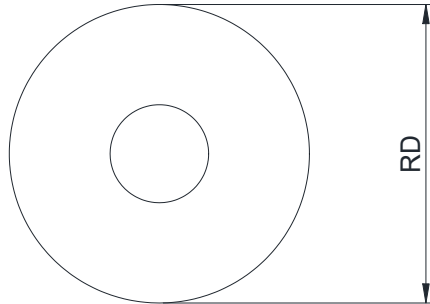

Tape Dimensions

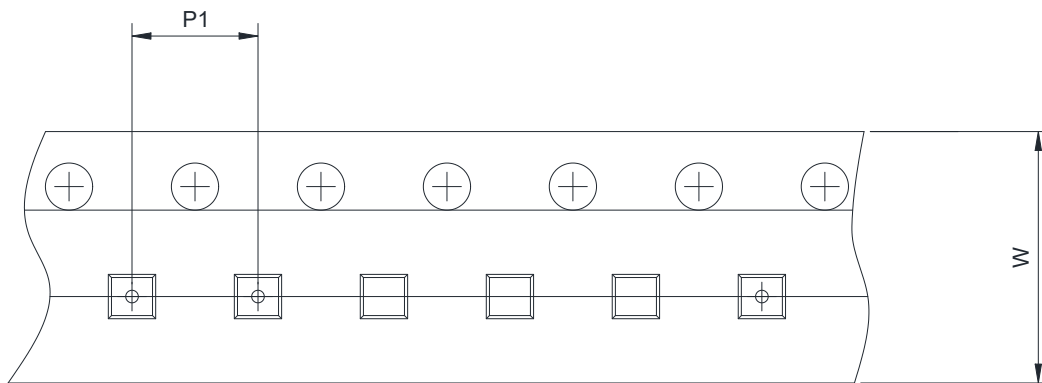

Quadrant Assignments For PIN1 Orientation In Tape

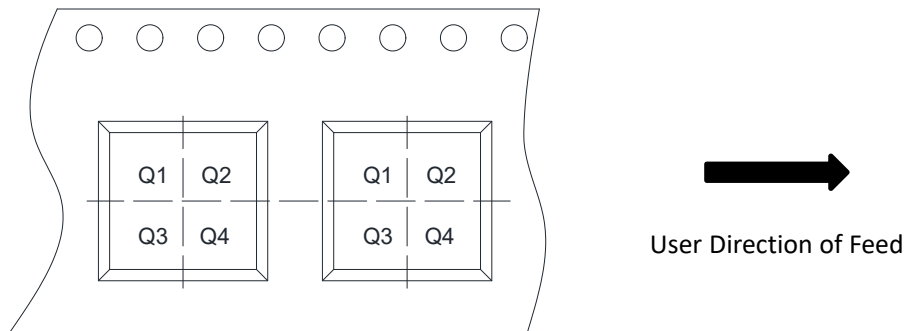

R	Reel Dimension	<input checked="" type="checkbox"/> 7inch <input type="checkbox"/> 13inch
W	Overall width of the carrier tape	<input checked="" type="checkbox"/> 8mm <input type="checkbox"/> 12mm <input type="checkbox"/> 16mm
P1	Pitch between successive cavity centers	<input type="checkbox"/> 2mm <input checked="" type="checkbox"/> 4mm <input type="checkbox"/> 8mm
Pin1	Pin1 Quadrant	<input checked="" type="checkbox"/> Q1 <input type="checkbox"/> Q2 <input type="checkbox"/> Q3 <input type="checkbox"/> Q4



Attention

- Any and all HUA XUAN YANG ELECTRONICS products described or contained herein do not have specifications that can handle applications that require extremely high levels of reliability, such as life-support systems, aircraft's control systems, or other applications whose failure can be reasonably expected to result in serious physical and/or material damage. Consult with your HUA XUAN YANG ELECTRONICS representative nearest you before using any HUA XUAN YANG ELECTRONICS products described or contained herein in such applications.
- HUA XUAN YANG ELECTRONICS assumes no responsibility for equipment failures that result from using products at values that exceed, even momentarily, rated values (such as maximum ratings, operating condition ranges, or other parameters) listed in products specifications of any and all HUA XUAN YANG ELECTRONICS products described or contained herein.
- Specifications of any and all HUA XUAN YANG ELECTRONICS products described or contained herein stipulate the performance, characteristics, and functions of the described products in the independent state, and are not guarantees of the performance, characteristics, and functions of the described products as mounted in the customer's products or equipment. To verify symptoms and states that cannot be evaluated in an independent device, the customer should always evaluate and test devices mounted in the customer's products or equipment.
- HUA XUAN YANG ELECTRONICS CO.,LTD. strives to supply high-quality high-reliability products. However, any and all semiconductor products fail with some probability. It is possible that these probabilistic failures could give rise to accidents or events that could endanger human lives, that could give rise to smoke or fire, or that could cause damage to other property. When designing equipment, adopt safety measures so that these kinds of accidents or events cannot occur. Such measures include but are not limited to protective circuits and error prevention circuits for safe design, redundant design, and structural design.
- In the event that any or all HUA XUAN YANG ELECTRONICS products(including technical data, services) described or contained herein are controlled under any of applicable local export control laws and regulations, such products must not be exported without obtaining the export license from the authorities concerned in accordance with the above law.
- No part of this publication may be reproduced or transmitted in any form or by any means, electronic or mechanical, including photocopying and recording, or any information storage or retrieval system, or otherwise, without the prior written permission of HUA XUAN YANG ELECTRONICS CO.,LTD.
- Information (including circuit diagrams and circuit parameters) herein is for example only ; it is not guaranteed for volume production. HUA XUAN YANG ELECTRONICS believes information herein is accurate and reliable, but no guarantees are made or implied regarding its use or any infringements of intellectual property rights or other rights of third parties.
- Any and all information described or contained herein are subject to change without notice due to product/technology improvement, etc. When designing equipment, refer to the "Delivery Specification" for the HUA XUAN YANG ELECTRONICS product that you intend to use.