

Ø1.00
Pick Up Area

Contact Area

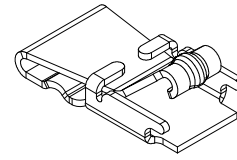

3D View

NOTES:

1:MATERIAL

1-1: SUS-304 THICKNE=0.10MM

2:SPECIFICATIONS

2-1: RATED CURRENT: 1.0A

2-2: VOLTAGE RATING: 1.5V

2-3: CONTACT RESISTANCE: 80mΩ/MAX

2-4: WELDING THRUST: ≥3KG

2-5: OPERATING TEMPERATURE: -40°C~+85°C

3:DURABILITY: 1500 CYCLES

4:SALT SPRAY TIME: 24H

5:ELECTROPLATE: THE NICKEL-PLATED SUBSTRATE IS 50u" MIN

6:REQUIREMENTS

6-1:TERMINAL TO EAT FULL TIN,NOTPEELING,
WELDING OBVIOUS COLOR AND OTHER ADVERSE
6-2:ROHS, REACH, HF HALOGER ADVERSE OF DOMESTIC
AND INTERNATIONAL ENVIRONMNTAL REQUIREMENTS

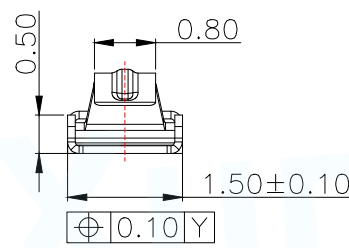
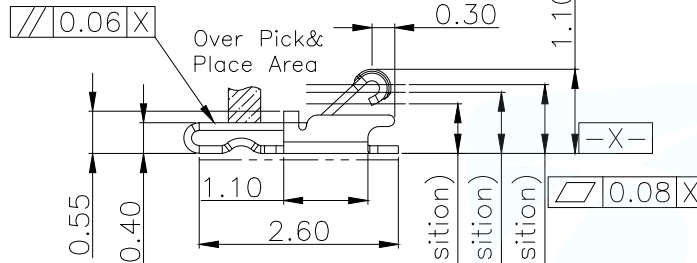
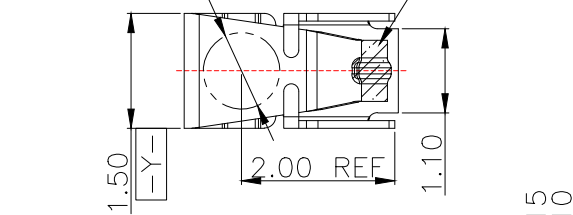

Solder Area

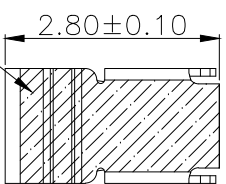

0.65(Max.Working Position)
0.80(Working Position)
0.90(Min.Working Position)

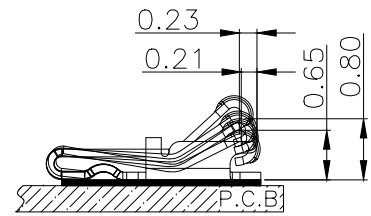

(For Reference Only)
Stated At Compression

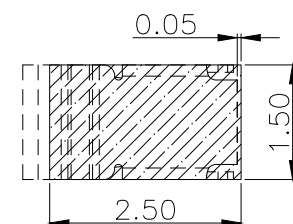

RECOMMENDED PCB LAYOUT

TOLERANCE:±0.05MM
(FOR REFERENCE ONLY)

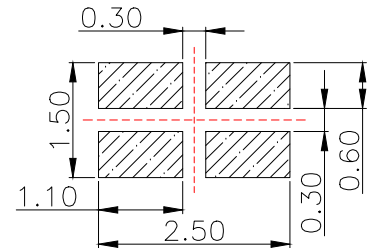

METAL MASK T=0.08

TOLERANCE:±0.05MM
(FOR REFERENCE ONLY)

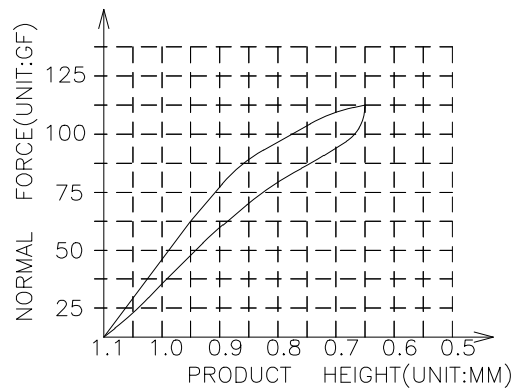

MANUFACTURE DWG		东莞市讯普电子科技有限公司 DongGuan XunPu Electronics Co.,Ltd	
UNLESS OTHERWISE SPECIFIED TOLERANCES			TITLE: 天线弹片 L2.80*W1.50*H1.10
			PAR: ASP-D1101-B01
DECIMALS:	ANGLES:	DWN	
X. ±0.30	X. ° ±0.20	CHKD	
.X ±0.20	.X ° ±0.10	APVD	
.XX ±0.15	.XX ° ±0.5	SCALE N:A	UNIT:MM
		SIZE:A4	SHEET:1F1
		CUSTOMER COPY	REV:A

12	13	14	15
MAPX	MODIFICATION	DATE	APPROVE

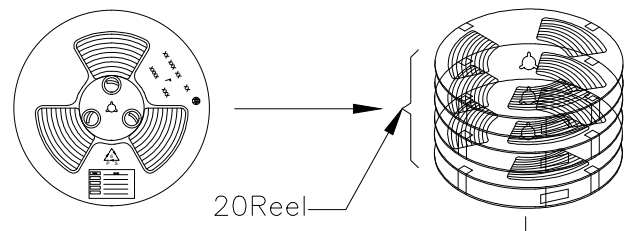
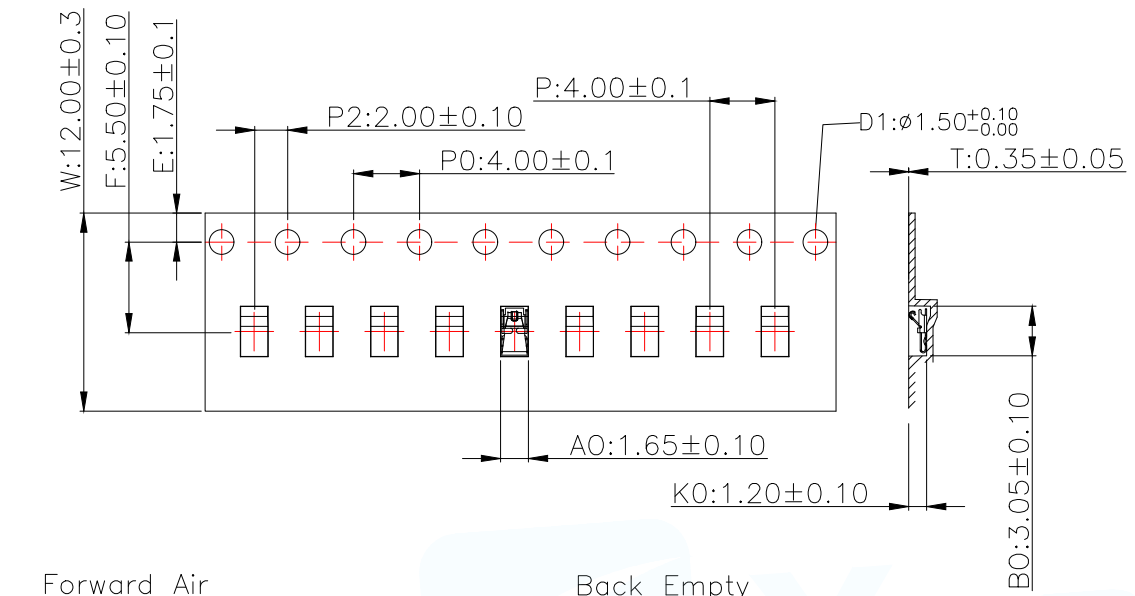

Carton Size
290*330*4 K3K

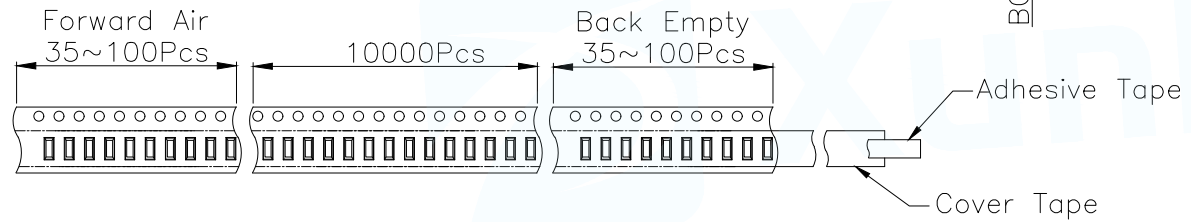

Carton Size
345*345*360 K=K

The Carrier Tape Is Heat-Sealed
Packaging The Peeling Angle Of The
Heat-Sealing Cover Tape Is 165°~180°
And The Peeling Force Is 30~120g.

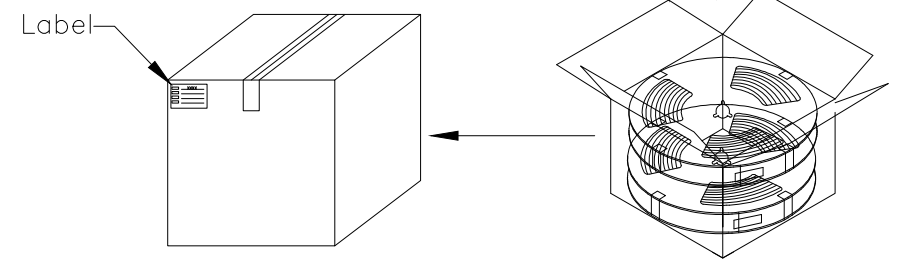
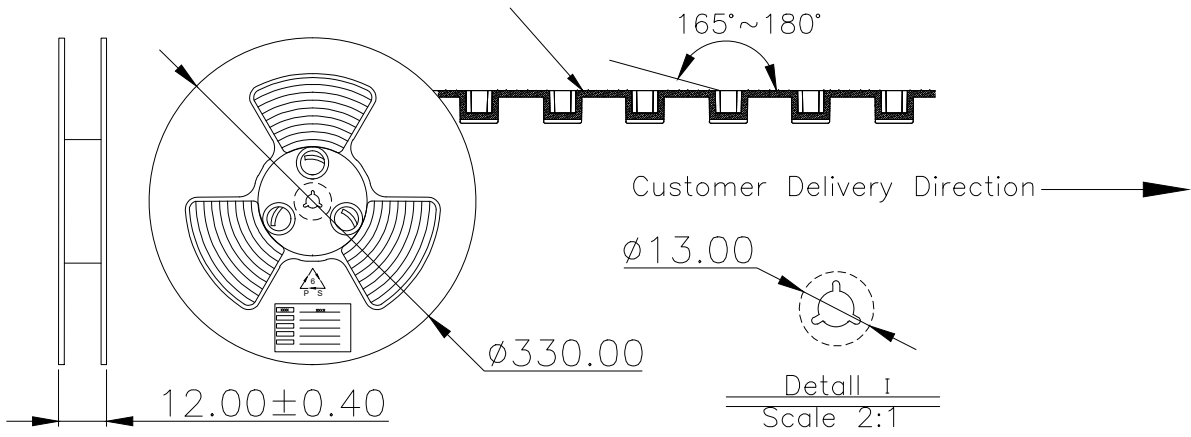

MANUFACTURE DWG		东莞市讯普电子科技有限公司 DongGuan XunPu Electronics Co.,Ltd	
UNLESS OTHERWISE SPECIFIED TOLERANCES			TITLE: 天线弹片 L2.80*W1.50*H1.10
DECIMALS:	ANGLES:		PAR ASP-D1101-B01
X. ±0.30 X. ° ±0.20	.X ±0.20 .X ° ±0.10		DWN
.XX ±0.15 .XX ° ±0.5			CHKD
		SCALE N:A	UNIT:MM
		SIZE:A4	SHEET:1F1
		CUSTOMER COPY	REV:A

Detail I
Scale 2:1