

TDS:EMIC

拓電半導體

自主封測 品質把控 售後保障

WEB | WWW.TDSEMIC.COM



電源管理

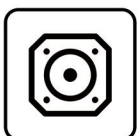

顯示驅動

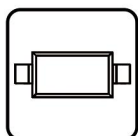

二三極管

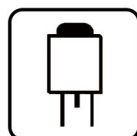

LDO穩壓器

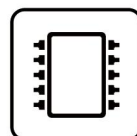

觸摸芯片

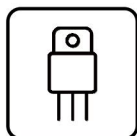

MOS管



運算放大器

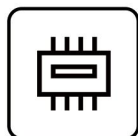

存儲芯片



MCU



串口通信

ST232BDR

產品規格說明書

FEATURES

- Output voltage levels are compatible with input levels of CMOS and TTL integrated circuits
- Meets All EIA/TIA-232E and V.28/V.24 Specifications
- Supply voltage range from 5.5V
- Low input current: 1.0 μ A at 25°C
- Output current 30mA
- Available in SOP-16 Package

APPLICATIONS

- Portable Computers
- Battery-Powered RS-232 Systems
- Interface Translation
- Low-Power Modems
- Terminals

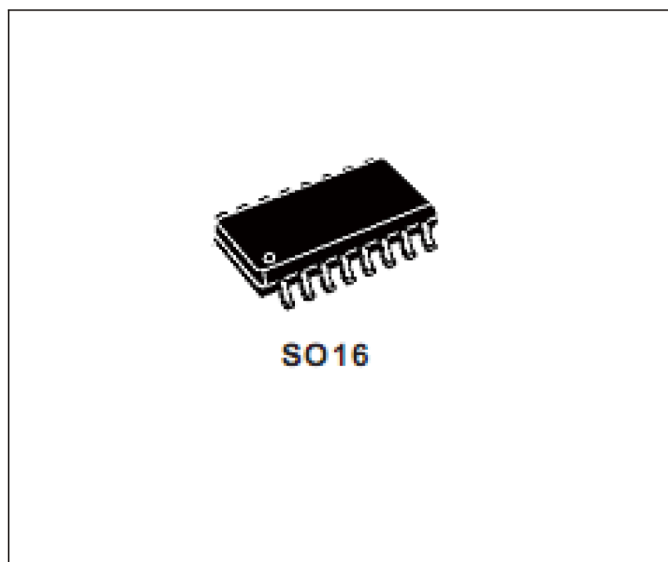

ORDERING INFORMATION

| | |
|----------|---------|
| Device | Package |
| ST232BDR | SOP-16 |

* Refer to the ordering information for the details.

DESCRIPTION

The ST232BDR is a dual driver/receiver of RS-232 standard with a single supply voltage and bipolar output voltage of the transmitter formed by a built-in voltage multiplying generator on four 1.0 μ F external capacitors, designed for use in state-of-the-art high performance computing systems, high-speed electronic devices with high reliability of information exchange between remote objects.

Input voltage levels are compatible with standard CMOS and TTL levels.

ABSOLUTE MAXIMUM RATINGS

| PARAMETER | SYMBOL | MIN. | MAX. | UNIT |
|---------------------------------------|------------|--------------|--------------|------|
| Supply Voltage | V_{CC} | -0.3 | 6.0 | V |
| Transmitter High Output Voltage | V_+ | $V_{CC}-0.3$ | 9.8 | V |
| Transmitter Low Output Voltage | V_- | -9.0 | 0.3 | V |
| Transmitter Input Voltage | V_{TIN} | -0.3 | $V_++0.3$ | V |
| Receiver Input Voltage | V_{RIN} | -20 | 20 | V |
| Voltage Applied to Transmitter Output | V_{TOUT} | $V_- - 0.3$ | $V_++0.3$ | V |
| Voltage Applied to Receiver Output | V_{ROUT} | -0.3 | $V_{CC}+0.3$ | V |
| Storage Temperature Range | T_{STG} | -65 | 150 | °C |

RECOMMENDED OPERATING CONDITIONS

| PARAMETER | SYMBOL | MIN. | MAX. | UNIT |
|---|-----------|------|----------|-------------|
| Supply Voltage | V_{CC} | 4.5 | 5.5 | V |
| Transmitter Input Voltage | V_{TIN} | 0 | V_{CC} | V |
| Receiver Input Voltage | V_{RIN} | -20 | 20 | V |
| Output Current of Transmitter Short Circuit | I_{SC} | - | ± 60 | mA |
| Ambient Temperature Range | T_A | -40 | +85 | $^{\circ}C$ |

ORDERING INFORMATION

| Package | Oder No. | Package Marking | Compliance | Supplied As |
|---------|----------|-----------------|-------------|-------------|
| SOP -16 | ST232BDR | ST232BDR | RoHS, Green | Tube |

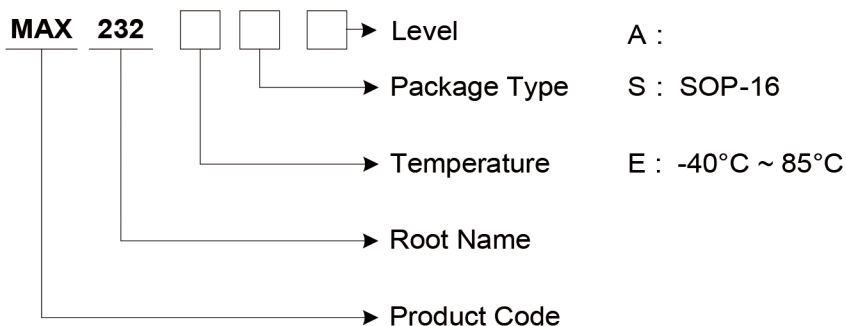

PIN CONFIGURATION

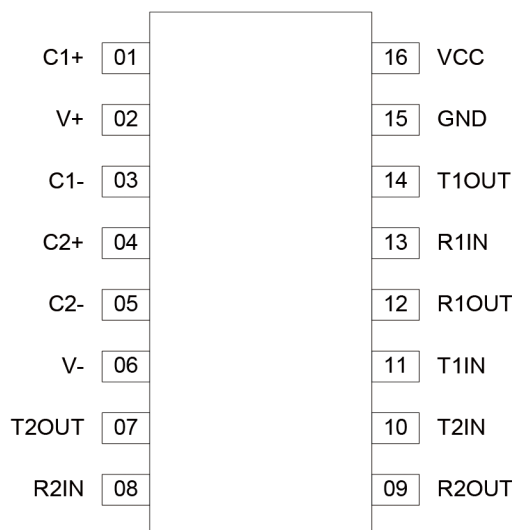

SOP -16 PKG

PIN DESCRIPTION

| Pin No. | Pin Name | Pin Description |
|---------|----------|--|
| 1 | C1+ | Terminal for Positive Charge-Pump C1 Capacitor |
| 2 | V+ | Positive Voltage Generated by the Charge-Pump |
| 3 | C1- | Terminal for Negative Charge-Pump C1 Capacitor |
| 4 | C2+ | Terminal for Positive Charge-Pump C2 Capacitor |
| 5 | C2- | Terminal for Negative Charge-Pump C2 Capacitor |
| 6 | V- | Negative Voltage Generated by the Charge-Pump |
| 7 | T2OUT | RS-232 Driver Output (Levels RS-232) |
| 8 | R2IN | RS-232 Receiver Input (Levels RS-232) |
| 9 | R2OUT | RS-232 Receiver Output (Levels TTL/CMOS) |
| 10 | T2IN | RS-232 Driver Input (Levels TTL/CMOS) |
| 11 | T1IN | RS-232 Driver Input (Levels TTL/CMOS) |
| 12 | R1OUT | RS-232 Receiver Output (Levels TTL/CMOS) |
| 13 | R1IN | RS-232 Receiver Input (Levels RS-232) |
| 14 | T1OUT | RS-232 Driver Output (Levels RS-232) |
| 15 | GND | Ground |
| 16 | VCC | Supply Voltage Input |

TYPICAL APPLICATION CIRCUIT

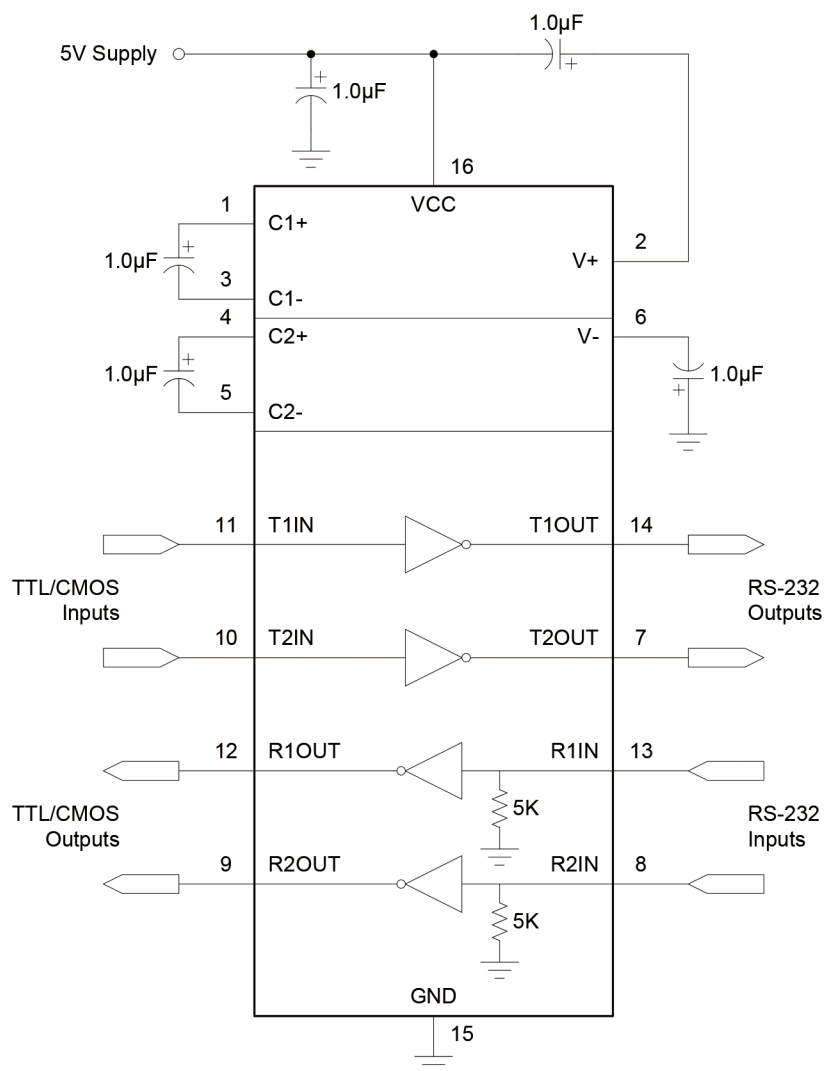

FUNCTION TABLE

| INPUT (RIN, TIN) | OUTPUT (ROUT, TOUT) |
|---------------------|------------------------|
| L (Low Level) | H (High Level) |
| H (High Level) | L (Low Level) |

ELECTRICAL CHARACTERISTICS

(Limits in standard typeface are for $T_A=25^{\circ}\text{C}$, and the limits in boldface type apply over full operating temperature range.)

| PARAMETER | SYMBOL | TEST CONDITIONS | MIN. | TYP. | MAX. | UNIT | |
|--|------------------------------|---|-------------------|------|----------------------|-------------------|----|
| Supply Current | I_{CC} | $V_{CC} = 5.5\text{V}$ $V_{IL} = 0\text{V}$ | - | - | 10.0 14.0 | mA | |
| Receiver Parameters | | | | | | | |
| Hysteresis Voltage | V_h | $V_{CC} = 5.0\text{V}$ | 0.2 0.2 | - | 0.9 1.0 | V | |
| On (Operation) Voltage | V_{on} | $V_O \leq 0.1\text{V}$, $I_{OL} \leq 20\mu\text{A}$ | - | - | 2.4 2.3 | V | |
| Off (Dropout) Voltage | V_{off} | $V_O \geq V_{CC} - 0.1\text{V}$ $I_{OH} \leq -20\mu\text{A}$ | 0.8 0.9 | - | - | V | |
| Output Low Voltage | V_{OL} | $I_L = 3.2\text{mA}$, $V_{CC} = 4.5\text{V}$, $V_{IH} = 2.4\text{V}$ | - | - | 0.3 0.4 | V | |
| Output High Voltage | V_{OH} | $I_{OH} = -1.0\text{mA}$, $V_{CC} = 4.5\text{V}$, $V_{IL} = 0.8\text{V}$ | 3.6 3.5 | - | - | V | |
| Input Resistance | R_i | $V_{CC} = 5.0\text{V}$ | 3.0 3.0 | - | 7.0 7.0 | k Ω | |
| Transmitter Parameters | | | | | | | |
| Output Low Voltage | V_{OL} | $V_{CC} = 4.5\text{V}$, $V_{IH} = 2.0\text{V}$, $R_L = 3.0\text{k}\Omega$ | - | - | -5.2 -5.0 | V | |
| Output High Voltage | V_{OH} | $V_{CC} = 4.5\text{V}$, $V_{IL} = 0.8\text{V}$, $R_L = 3.0\text{k}\Omega$ | 5.2 5.0 | - | - | V | |
| Input Low Current | I_{IL} | $V_{CC} = 5.5\text{V}$, $V_{IL} = 0\text{V}$ | - | - | -1.0 -10.0 | μA | |
| Input High Current | I_{IH} | $V_{CC} = 5.5\text{V}$, $V_{IH} = V_{CC}$ | - | - | 1.0 10.0 | μA | |
| Speed Of Output Front Charge | SR | $V_{CC} = 5.0\text{V}$, $C_L = 50 - 1000\text{pF}$, $R_L = 3.0 - 7.0\text{k}\Omega$ | 3.0 2.7 | - | 30 27 | V/ μs | |
| Output Resistance | R_O | $V_{CC} = V_+ = V_- = 0\text{V}$ $V_O = \pm 2\text{V}$ | 350 300 | - | - | Ω | |
| Short Circuit Output Current | I_{sc} | $V_{CC} = 5.5\text{V}$ $V_O = 0\text{V}$ | $V_I = V_{CC}$ | - | - | -50 -60 | mA |
| | | | $V_I = 0$ | - | - | 50 60 | |
| Speed Of Information Transmission | ST | $V_{CC} = 4.5\text{V}$, $C_L = 1000\text{pF}$, $R_L = 3.0\text{k}\Omega$, $t_w = 7\mu\text{s}$ (for extreme, $t_w = 8\mu\text{s}$) | 140 120 | - | - | kbit/s | |
| Dynamic Parameters | | | | | | | |
| Signal Propagation Delay Time When Switching On (Off) | t_{PHLR} (t_{PLHR}) | $V_{CC} = 4.5\text{V}$, $C_L = 150\text{pF}$, $V_{IL} = 0\text{V}$, $V_{IH} = 3.0\text{V}$, $t_{LH} = t_{HL} \leq 10\text{ns}$ | - | - | 9.7 10.0 | μs | |
| Signal Propagation Delay Time When Switching On (Off) | t_{PHLT} (t_{PLHT}) | $V_{CC} = 4.5\text{V}$, $C_L = 2500\text{pF}$, $V_{IL} = 0\text{V}$, $V_{IH} = 3.0\text{V}$, $R_L = 3\text{k}\Omega$, $t_{LH} = t_{HL} \leq 10\text{ns}$ | - | - | 5.0 6.0 | μs | |

TIMING DIAGRAM

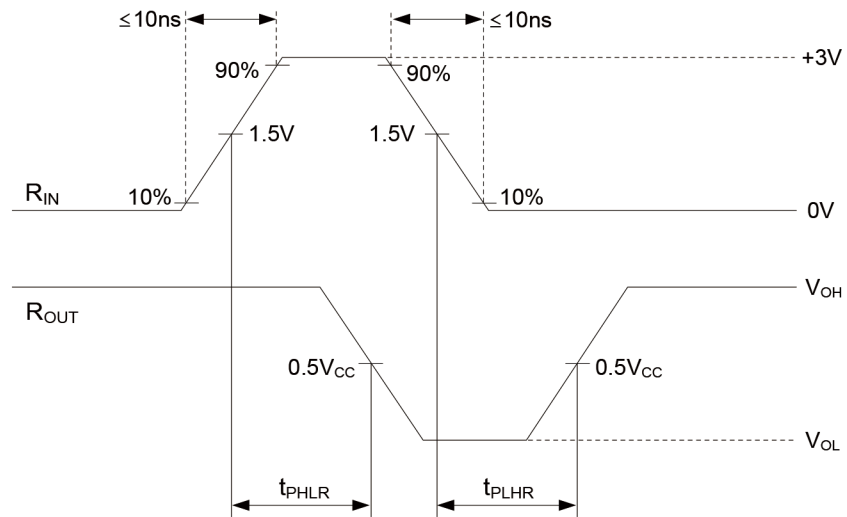

Figure 1. t_{PHL} and t_{PLH} waveforms of Receiver

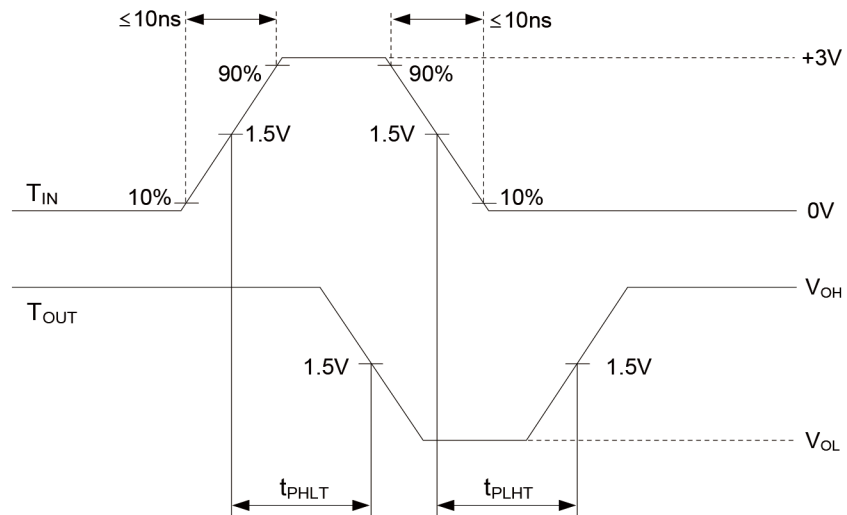

Figure 2. t_{PHL} and t_{PLH} waveforms of Transmitter

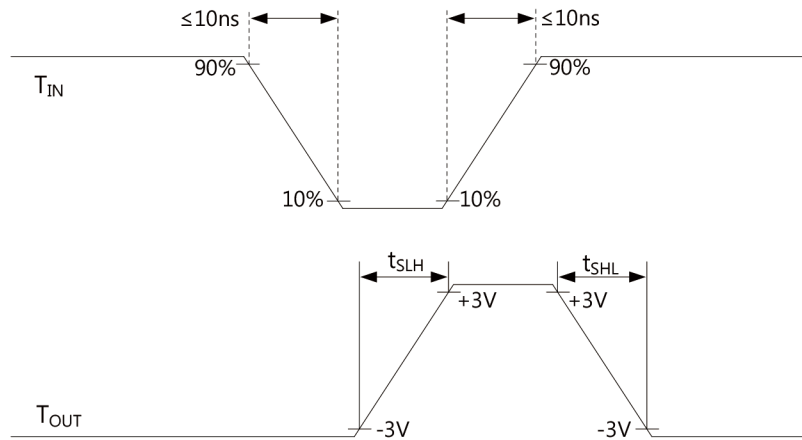

Figure 3. t_{SLH} and t_{SHL} waveforms of Transmitter

REVISION NOTICE

The description in this datasheet is subject to change without any notice to describe its electrical characteristics properly.