

Description:

This N-Channel MOSFET uses advanced trench technology and design to provide excellent $R_{DS(on)}$ with low gate charge. It can be used in a wide variety of applications.

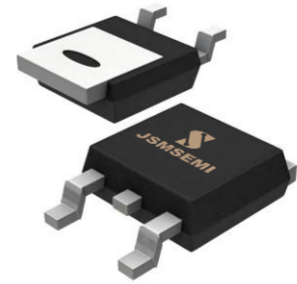

TO-252

Features:

- 1) $V_{DS}=30V, I_D=55A, R_{DS(ON)} < 10m\ \Omega @ V_{GS}=10V$
- 2) Low gate charge.
- 3) Green device available.
- 4) Advanced high cell density trench technology for ultra low $R_{DS(ON)}$.
- 5) Excellent package for good heat dissipation.

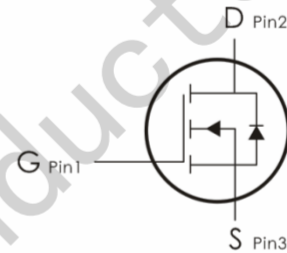

Absolute Maximum Ratings: ($T_C=25^\circ C$ unless otherwise noted)

Symbol	Parameter	Ratings	Units
V_{DS}	Drain-Source Voltage	30	V
V_{GS}	Gate-Source Voltage	± 20	V
I_D	Continuous Drain Current- $T_C=25^\circ C^1$	55	A
	Continuous Drain Current- $T_C=100^\circ C$	30	
	Pulsed Drain Current ²	112	
E_{AS}	Single Pulse Avalanche Energy ³	24.2	mJ
I_{AS}	Avalanche Current	22	A
P_D	Power Dissipation, $T_C=25^\circ C^4$	37.5	W
T_J, T_{STG}	Operating and Storage Junction Temperature Range	-55 to +175	$^\circ C$

Thermal Characteristics:

Symbol	Parameter	Max	Units
$R_{\theta JC}$	Thermal Resistance, Junction to Case ¹	4	$^\circ C/W$
$R_{\theta JA}$	Thermal Resistance Junction-Ambient ¹	62	$^\circ C/W$

Electrical Characteristics: ($T_C=25^\circ\text{C}$ unless otherwise noted)

Symbol	Parameter	Conditions	Min	Typ	Max	Units
Off Characteristics						
BV_{DSS}	Drain-Source Breakdown Voltage	$V_{GS}=0V, I_D=250\ \mu\text{A}$	30	---	---	V
I_{DSS}	Zero Gate Voltage Drain Current	$V_{GS}=0V, V_{DS}=30V$	---	---	1	μA
I_{GSS}	Gate-Source Leakage Current	$V_{GS}=\pm 20V, V_{DS}=0A$	---	---	± 100	nA
On Characteristics						
$V_{GS(th)}$	GATE-Source Threshold Voltage	$V_{GS}=V_{DS}, I_D=250\ \mu\text{A}$	1.2	---	2.5	V
$R_{DS(ON)}$	Drain-Source On Resistance ²	$V_{GS}=10V, I_D=30A$	---	7.5	10	m Ω
		$V_{GS}=4.5V, I_D=15A$	---	11	18	
Dynamic Characteristics						
C_{iss}	Input Capacitance	$V_{DS}=15V, V_{GS}=0V, f=1\text{MHz}$	---	940	---	pF
C_{oss}	Output Capacitance		---	131	---	
C_{rss}	Reverse Transfer Capacitance		---	109	---	
Switching Characteristics						
$t_{d(on)}$	Turn-On Delay Time	$V_{DD}=15V, I_D=15A,$ $V_{GS}=10V, R_{GEN}=3.3\Omega$	---	4	---	ns
t_r	Rise Time		---	8	---	ns
$t_{d(off)}$	Turn-Off Delay Time		---	31	---	ns
t_f	Fall Time		---	4	---	ns
Q_g	Total Gate Charge		---	9.8	---	nC
Q_{gs}	Gate-Source Charge	$V_{GS}=4.5V, V_{DS}=15V,$	---	4.2	---	nC
Q_{gd}	Gate-Drain "Miller" Charge	$I_D=15A$	---	3.6	---	nC
Drain-Source Diode Characteristics						

V_{SD}	Source-Drain Diode Forward Voltage	V _{GS} =0V, I _S =1A	---	---	1	V
I_S	Continuous Source Current ^{1,5}	V _G =V _D =0V, Force Current	---	---	43	A
I_{SM}	Pulsed Source Current ^{2,5}		---	--	112	Ns
T_{rr}	Reverse Recovery Time	I _F =30A, dI/dt=100A/μs, T _J =25°C	---	8.5	---	
Q_{rr}	Reverse Recovery Charge		---	2.2	---	

Notes:

- 1.The data tested by surface mounted on a 1 inch² FR-4 board with 2OZ copper.
- 2.The data tested by pulsed, pulse width ≤ 300us, duty cycle ≤ 2%
- 3.The EAS data shows Max. rating. The test condition is V_{DD}=25V, V_{GS}=10V, L=0.1mH, I_{AS}=22A
- 4.The power dissipation is limited by 175°C junction temperature
- 5.The data is theoretically the same as I_D and I_{DM}, in real applications, should be limited by total power dissipation.

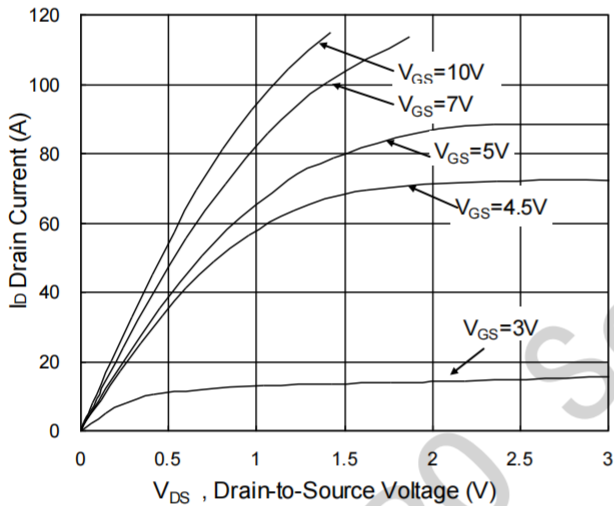
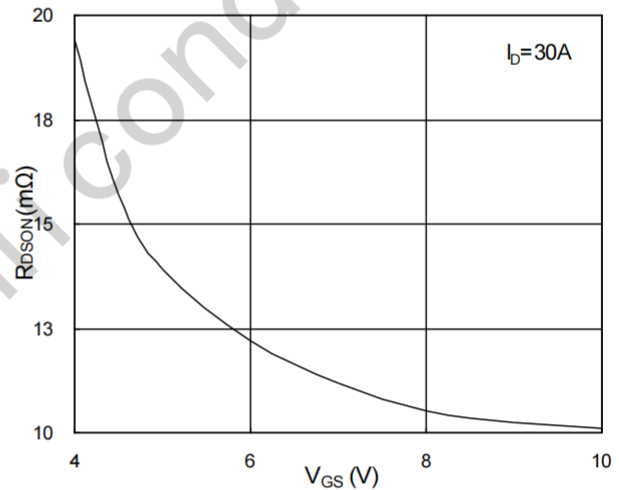
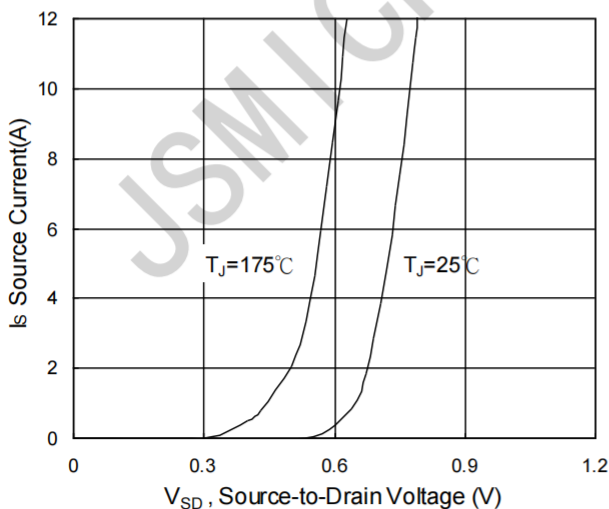
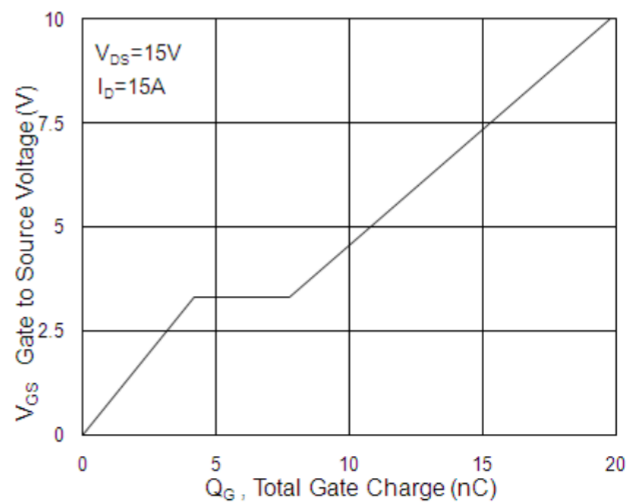
Typical Characteristics: (T_C=25°C unless otherwise noted)

Fig.1 Typical Output Characteristics

Fig.2 On-Resistance vs. G-S Voltage

Fig.3 Forward Characteristics of Reverse

Fig.4 Gate-Charge Characteristics

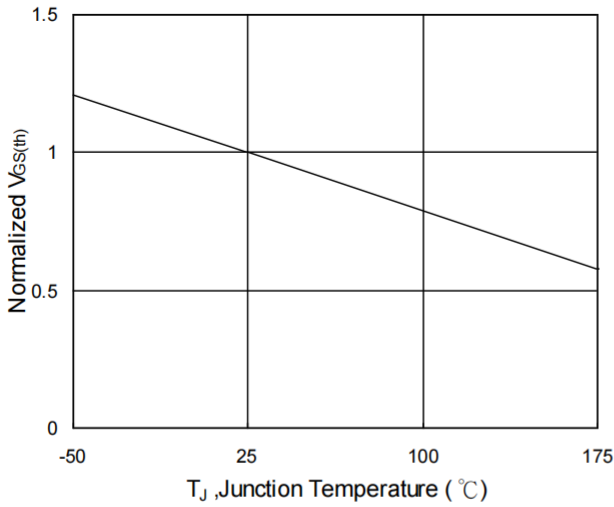

Fig.5 Normalized $V_{GS(th)}$ vs. T_J

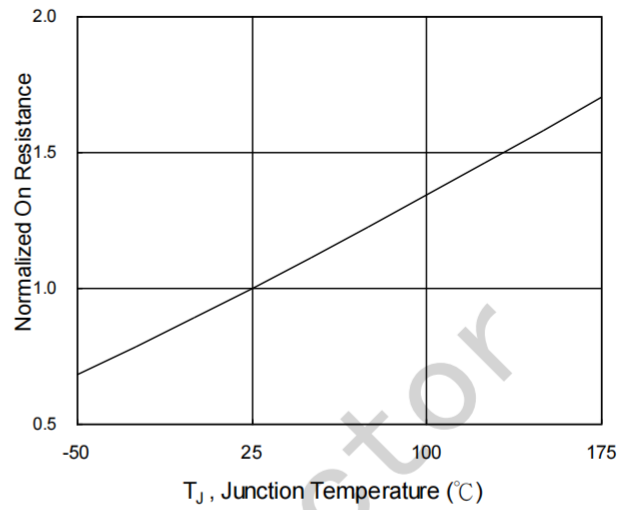

Fig.6 Normalized $R_{DS(on)}$ vs. T_J

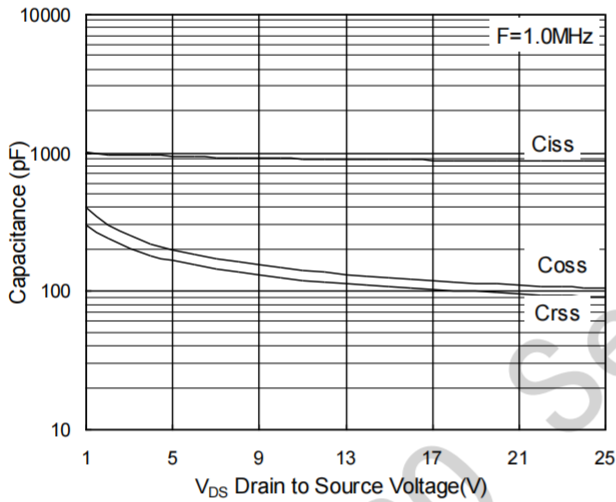

Fig.7 Capacitance

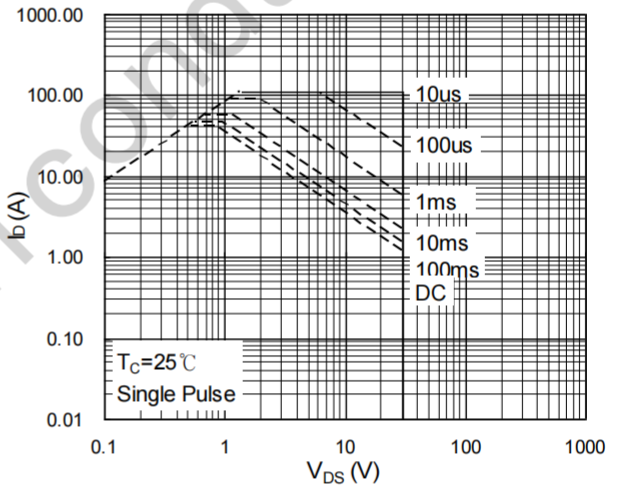

Fig.8 Safe Operating Area

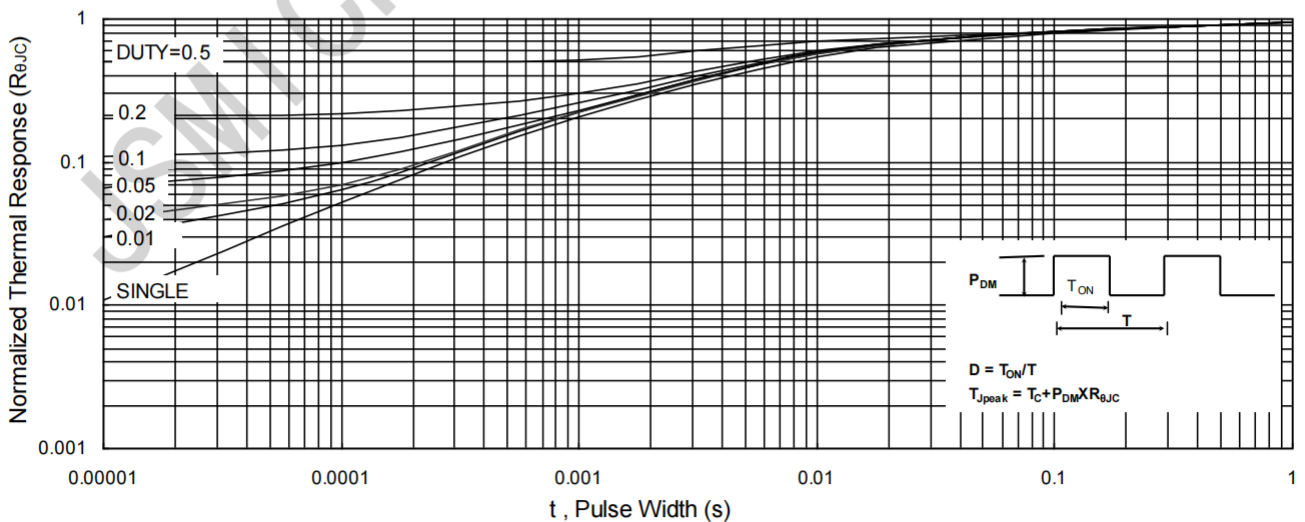
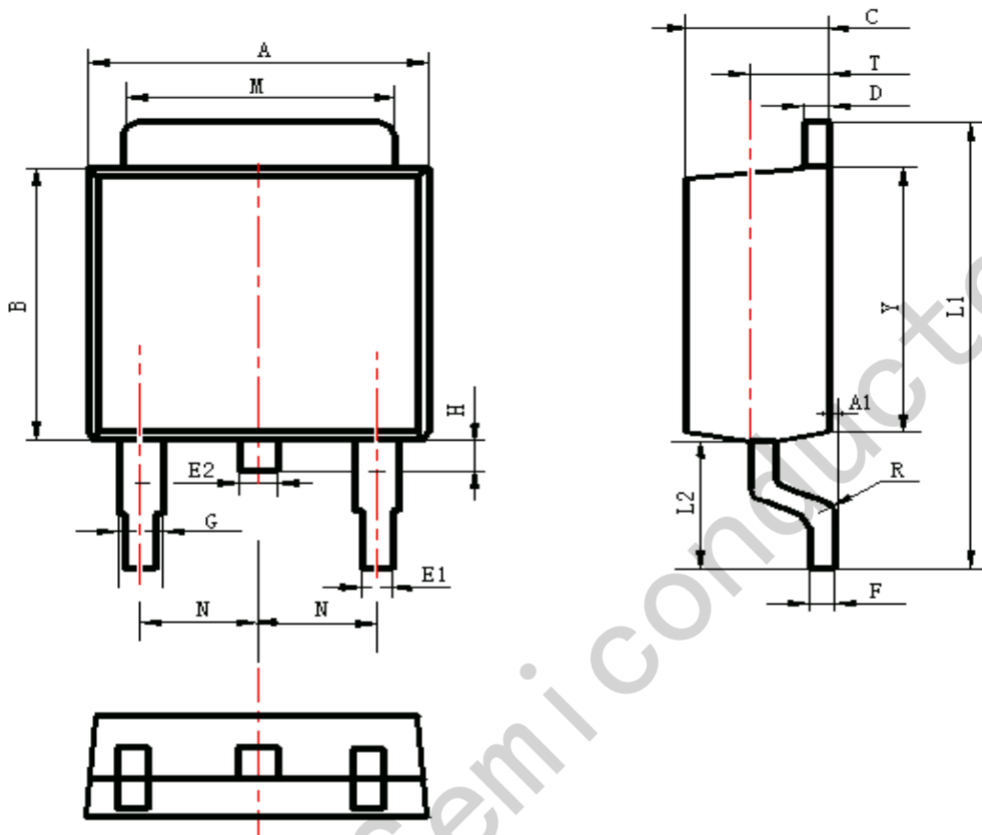

Fig.9 Normalized Maximum Transient Thermal Impedance

Package Information

TO-252



Symbol	Dimensions In Millimeters		Dimensions In Inches	
	Min.	Max.	Min.	Max.
A	6.30	6.90	0.248	0.272
A1	0.00	0.16	0.000	0.006
B	5.70	6.30	0.224	0.248
C	2.10	2.50	0.083	0.098
D	0.30	0.70	0.012	0.028
E1	0.60	0.90	0.024	0.035
E2	0.70	1.00	0.028	0.039
F	0.30	0.60	0.012	0.024
G	0.70	1.20	0.028	0.047
L1	9.60	10.50	0.378	0.413
L2	2.70	3.10	0.106	0.122
H	0.40	1.00	0.016	0.039
M	5.10	5.50	0.201	0.217
N	2.09	2.49	0.082	0.098
R	0.30		0.012	
T	1.40	1.60	0.055	0.063
Y	5.10	6.30	0.201	0.248