

Description:

This N-Channel MOSFET uses advanced SGT technology and design to provide excellent $R_{DS(on)}$ with low gate charge.

It can be used in a wide variety of applications.

Features:

- 1) $V_{DS}=100V, I_D=36A, R_{DS(ON)}<20m\ \Omega$ @ $V_{GS}=10V$
- 2) Low gate charge.
- 3) Green device available.
- 4) Advanced high cell density trench technology for ultra low $R_{DS(ON)}$.
- 5) Excellent package for good heat dissipation.

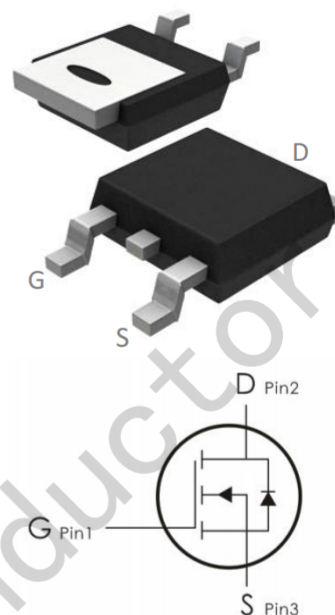

Absolute Maximum Ratings: ($T_C=25^\circ C$ unless otherwise noted)

Symbol	Parameter	Ratings	Units
V_{DS}	Drain-Source Voltage	100	V
V_{GS}	Gate-Source Voltage	± 20	V
I_D	Continuous Drain Current ¹⁾ , $T_C=25^\circ C$	36	A
$I_{D, pulse}$	Pulsed drain current ²⁾ , $T_C=25^\circ C$	90	A
I_S	Continuous diode forward current ¹⁾ , $T_C=25^\circ C$	30	A
$I_{S, pulse}$	Diode pulsed current ²⁾ , $T_C=25^\circ C$	90	A
P_D	Power dissipation ³⁾ , $T_C=25^\circ C$	71	W
E_{AS}	Single pulsed avalanche energy ⁵⁾	57	mJ
T_J, T_{STG}	Operating and Storage Junction Temperature Range	-55 to +150	$^\circ C$

Thermal Characteristics:

Symbol	Parameter	Max	Units
$R_{\theta JC}$	Thermal Resistance, Junction to Case	1.76	$^\circ C/W$
$R_{\theta JA}$	Thermal Resistance, Junction to Ambient ⁴⁾	62	

Electrical Characteristics: ($T_C=25^{\circ}\text{C}$ unless otherwise noted)

Symbol	Parameter	Conditions	Min	Typ	Max	Units
Off Characteristics						
BV_{DSS}	Drain-Source Breakdown Voltage	$V_{GS}=0V, I_D=250\ \mu\text{A}$	100	---	---	V
I_{DSS}	Zero Gate Voltage Drain Current	$V_{GS}=0V, V_{DS}=100V$	---	---	1	μA
I_{GSS}	Gate-Source Leakage Current	$V_{GS}=\pm 20V, V_{DS}=0A$	---	---	± 100	nA
On Characteristics						
$V_{GS(th)}$	GATE-Source Threshold Voltage	$V_{GS}=V_{DS}, I_D=250\ \mu\text{A}$	1.4	---	2.5	V
$R_{DS(on)}$	Drain-Source On Resistance	$V_{GS}=10V, I_D=10A$	---	13.8	20	m Ω
		$V_{GS}=4.5V, I_D=7A$	---	17.4	26	
Dynamic Characteristics						
C_{iss}	Input Capacitance	$V_{DS}=50V, V_{GS}=0V, f=100\text{KHz}$	---	1000	---	pF
C_{oss}	Output Capacitance		---	180	---	
C_{rss}	Reverse Transfer Capacitance		---	9.5	---	
Switching Characteristics						
$t_{d(on)}$	Turn-On Delay Time	$V_{DS}=50V, I_D=5A, V_{GS}=10V, R_G=10\Omega$	---	16.6	--	ns
t_r	Rise Time		---	3.8	---	ns
$t_{d(off)}$	Turn-Off Delay Time		---	75.5	---	ns
t_f	Fall Time		---	46	---	ns
Q_g	Total Gate Charge		---	16.2	---	nC
Q_{gs}	Gate-Source Charge	$V_{GS}=10V, V_{DS}=50V, I_D=5A$	---	2.8	---	nC
Q_{gd}	Gate-Drain Charge		---	4.1	---	nC
$V_{plateau}$	Gate plateau voltage		---	3	---	V
Drain-Source Diode Characteristics						
V_{SD}	Source-Drain Diode Forward Voltage	$V_{GS}=0V, I_S=12A$	---	---	1.3	V

trr	Reverse Recovery Time	$V_R=50\text{ V}, I_S=5\text{ A},$ $di/dt=100\text{ A}/\mu\text{ s}$	----	49	----	Nsn
qrr	Reverse Recovery Charge		----	61.8	----	c
I_{rmm}	Peak reverse recovery current			2.4		A

Notes:

- 1)2 Calculated continuous current based on maximum allowable junction temperature.
- 3) Repetitive rating; pulse width limited by max. junction temperature.
- 4)5 Pd is based on max. junction temperature, using junction-case thermal resistance.
-) The value of $R_{\theta JA}$ is measured with the device mounted on 1 in 2 FR-4 board with 2oz. Copper, in a still air environment with $T_a=25\text{ }^\circ\text{C}$.
 $V_{DD}=50\text{ V}, V_{GS}=10\text{ V}, L=0.3\text{ mH}$, starting $T_j=25\text{ }^\circ\text{C}$.

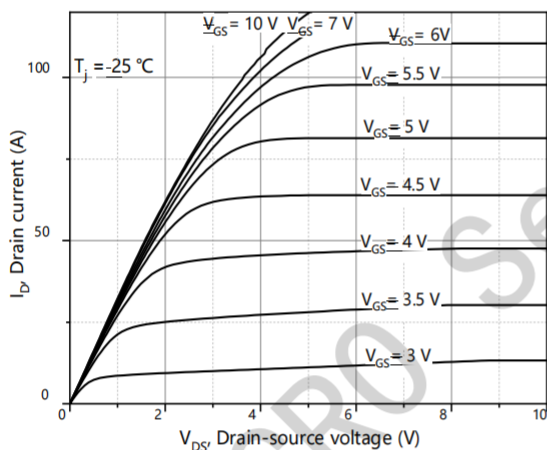
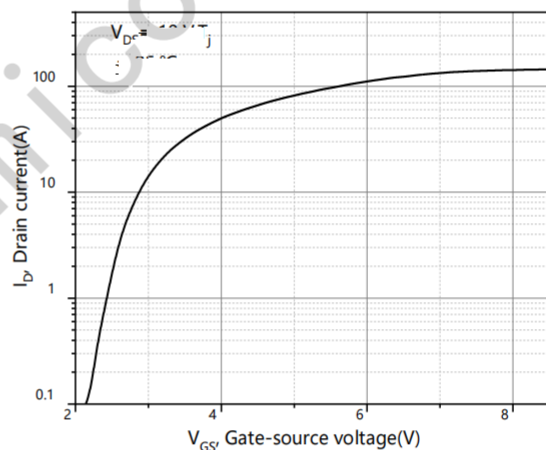
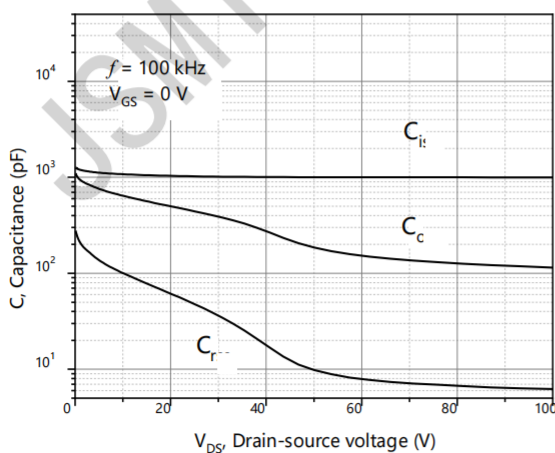
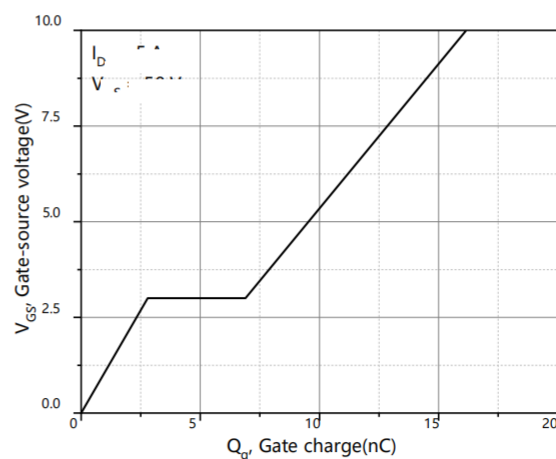
Typical Characteristics: ($T_C=25\text{ }^\circ\text{C}$ unless otherwise noted)

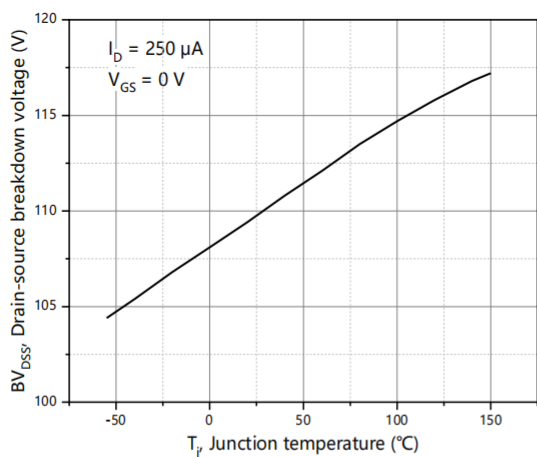
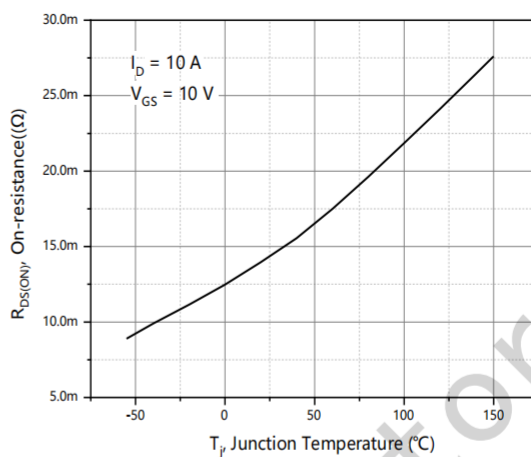
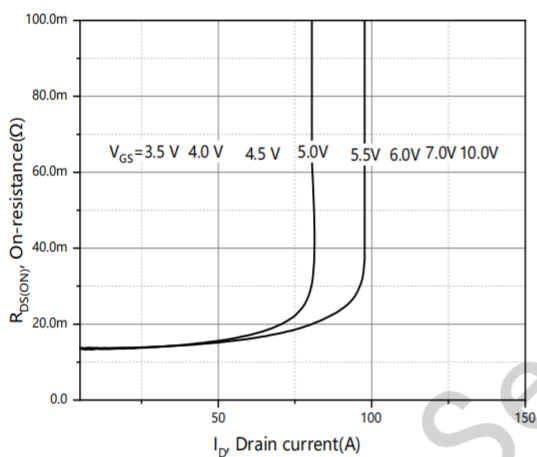
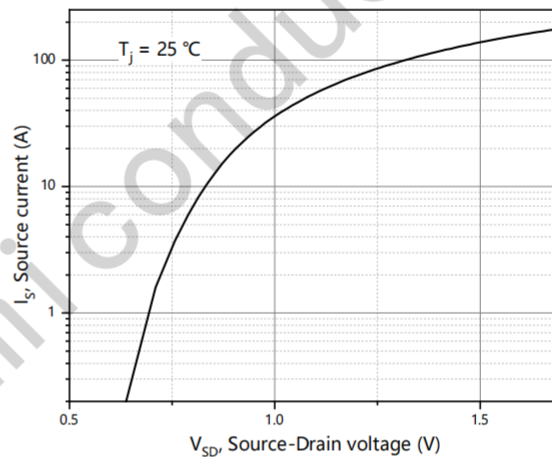
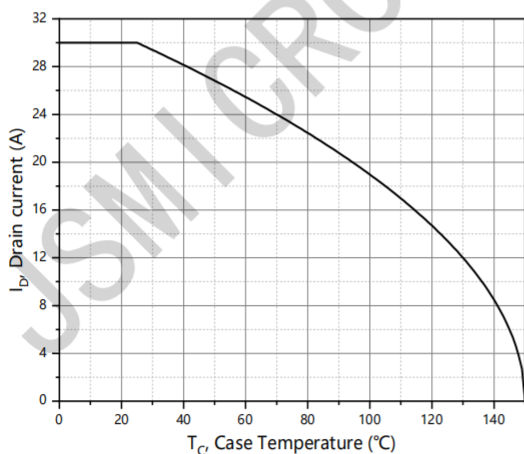
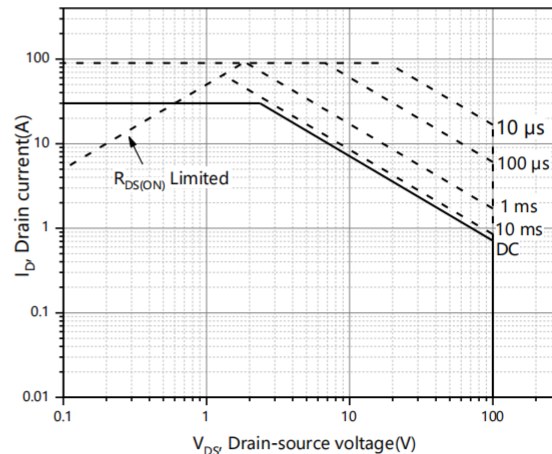
Figure 1. Typ. output characteristics

Figure 2. Typ. transfer characteristics

Figure 3. Typ. capacitances

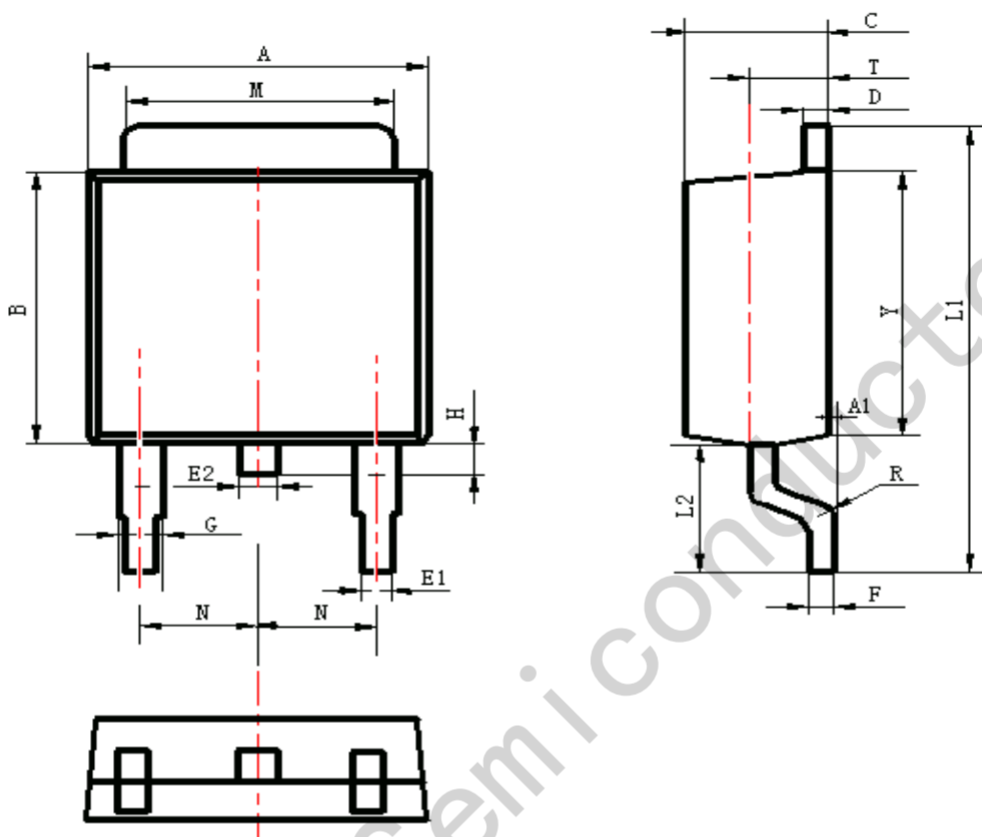
Figure 4. Typ. gate charge

Figure 5. Drain-source breakdown voltage

Figure 6. Drain-source on-state resistance

Figure 7. Drain-source on-state resistance

Figure 8. Forward characteristic of body diode

Figure 9. Drain current

Figure 10. Safe operation area $T_C=25\text{ }^\circ\text{C}$

Package Information

TO-252



Symbol	Dimensions In Millimeters		Dimensions In Inches	
	Min.	Max.	Min.	Max.
A	6.30	6.90	0.248	0.272
A1	0.00	0.16	0.000	0.006
B	5.70	6.30	0.224	0.248
C	2.10	2.50	0.083	0.098
D	0.30	0.70	0.012	0.028
E1	0.60	0.90	0.024	0.035
E2	0.70	1.00	0.028	0.039
F	0.30	0.60	0.012	0.024
G	0.70	1.20	0.028	0.047
L1	9.60	10.50	0.378	0.413
L2	2.70	3.10	0.106	0.122
H	0.40	1.00	0.016	0.039
M	5.10	5.50	0.201	0.217
N	2.09	2.49	0.082	0.098
R	0.30		0.012	
T	1.40	1.60	0.055	0.063
Y	5.10	6.30	0.201	0.248