

## Description

The AO4622 uses advanced trench technology to provide excellent  $R_{DS(ON)}$  and low gate charge. The complementary MOSFETs may be used to form a level shifted high side switch, and for a host of other applications.

## General Features

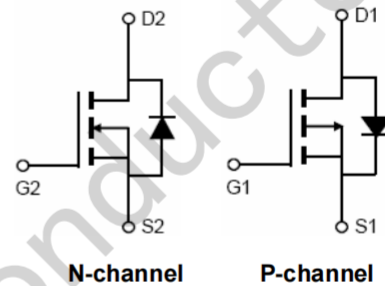
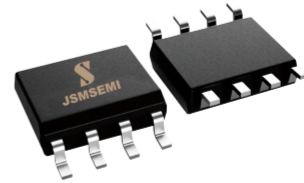
### ● N-Channel

$V_{DS} = 40V, I_D = 8.0A$   
 $R_{DS(ON)} < 22m\Omega @ V_{GS}=10V$   
 $R_{DS(ON)} < 31m\Omega @ V_{GS}=4.5V$

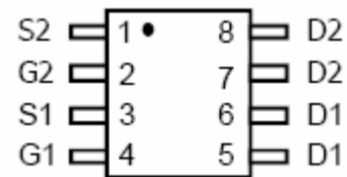
### ● P-Channel

$V_{DS} = -40V, I_D = -7.0A$   
 $R_{DS(ON)} < 35m\Omega @ V_{GS}=-10V$   
 $R_{DS(ON)} < 48m\Omega @ V_{GS}=-4.5V$

- High power and current handing capability
- Lead free product is acquired
- Surface mount package



Schematic diagram



Marking and pin assignment

## Absolute Maximum Ratings ( $T_A=25^\circ C$ unless otherwise noted)

Parameter	Symbol	N-Channel	P-Channel	Unit
Drain-Source Voltage	$V_{DS}$	40	-40	V
Gate-Source Voltage	$V_{GS}$	$\pm 20$	$\pm 20$	V
Continuous Drain Current	$I_D$	8.0	-7.0	A
Pulsed Drain Current <sup>(Note 1)</sup>	$I_{DM}$	40	-30	A
Maximum Power Dissipation	$P_D$	2.0	2.0	W
Operating Junction and Storage Temperature Range	$T_J, T_{STG}$	-55 To 150	-55 To 150	$^\circ C$

## Thermal Characteristic

Thermal Resistance, Junction-to-Ambient <sup>(Note2)</sup>	$R_{\theta JA}$	N-Ch	62.5	$^\circ C/W$
Thermal Resistance, Junction-to-Ambient <sup>(Note2)</sup>	$R_{\theta JA}$	P-Ch	62.5	$^\circ C/W$

**N-CH Electrical Characteristics ( $T_A=25^{\circ}\text{C}$  unless otherwise noted)**

Parameter	Symbol	Condition	Min	Typ	Max	Unit
<b>Off Characteristics</b>						
Drain-Source Breakdown Voltage	$BV_{DSS}$	$V_{GS}=0V, I_D=250\mu A$	40	-	-	V
Zero Gate Voltage Drain Current	$I_{DSS}$	$V_{DS}=40V, V_{GS}=0V$	-	-	1	$\mu A$
Gate-Body Leakage Current	$I_{GSS}$	$V_{GS}=\pm 20V, V_{DS}=0V$	-	-	$\pm 100$	nA

**On Characteristics (Note 3)**

Gate Threshold Voltage	$V_{GS(th)}$	$V_{DS}=V_{GS}, I_D=250\mu A$	1.0	1.4	2.0	V
Drain-Source On-State Resistance	$R_{DS(on)}$	$V_{GS}=10V, I_D=8A$	-	17	22	$m\Omega$
		$V_{GS}=4.5V, I_D=6A$	-	21	31	$m\Omega$
Forward Transconductance	$g_{FS}$	$V_{DS}=5V, I_D=8A$	15	-	-	S

**Dynamic Characteristics (Note4)**

Input Capacitance	$C_{iss}$	$V_{DS}=20V, V_{GS}=0V,$ $F=1.0MHz$	-	415	-	PF
Output Capacitance	$C_{oss}$		-	112	-	PF
Reverse Transfer Capacitance	$C_{rss}$		-	11	-	PF

**Switching Characteristics (Note 4)**

Turn-on Delay Time	$t_{d(on)}$	$V_{DD}=20V, R_L=2.5\Omega$ $V_{GS}=10V, R_{GEN}=3\Omega$	-	4.0	-	nS
Turn-on Rise Time	$t_r$		-	3.0	-	nS
Turn-Off Delay Time	$t_{d(off)}$		-	15	-	nS
Turn-Off Fall Time	$t_f$		-	2.0	-	nS
Total Gate Charge	$Q_g$	$V_{DS}=20V, I_D=8A,$ $V_{GS}=10V$	-	12	-	nC
Gate-Source Charge	$Q_{gs}$		-	3.5	-	nC
Gate-Drain Charge	$Q_{gd}$		-	3.1	-	nC

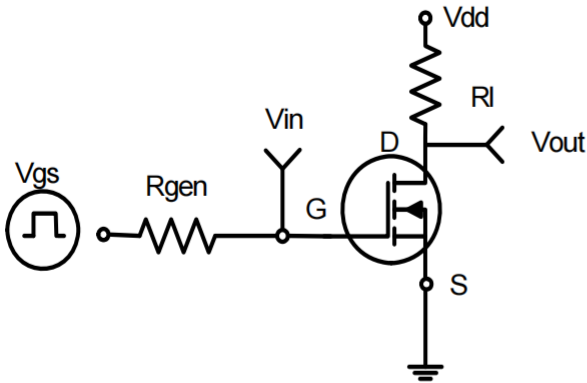
**Drain-Source Diode Characteristics**

Diode Forward Voltage (Note 3)	$V_{SD}$	$V_{GS}=0V, I_S=8A$	-	0.75	1.0	V
--------------------------------	----------	---------------------	---	------	-----	---

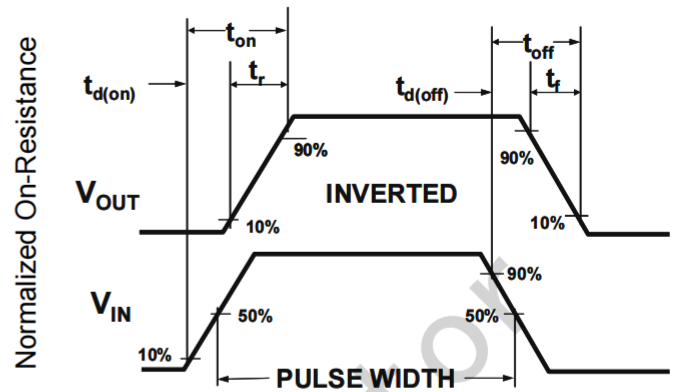
**Notes:**

1. Repetitive Rating: Pulse width limited by maximum junction temperature.
2. Surface Mounted on FR4 Board,  $t \leq 10$  sec.
3. Pulse Test: Pulse Width  $\leq 300\mu s$ , Duty Cycle  $\leq 2\%$ .
4. Guaranteed by design, not subject to production

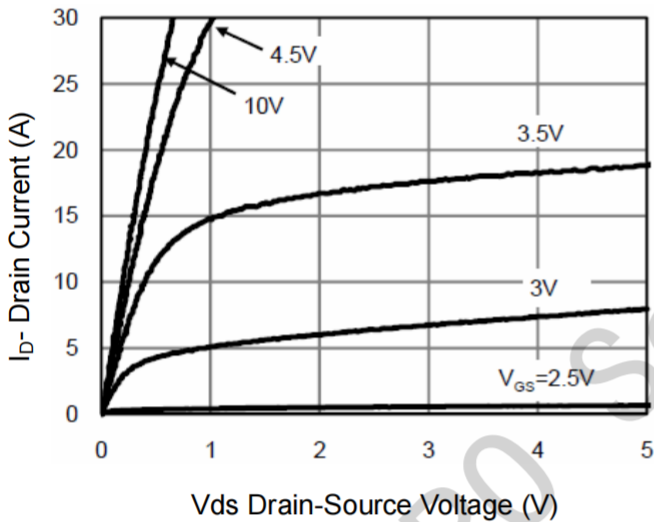
**N- Channel Typical Electrical and Thermal Characteristics (Curves)**



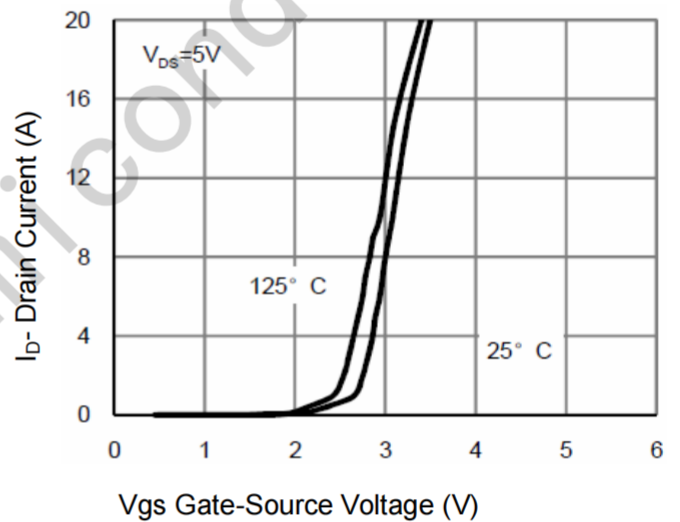
**Figure 1: Switching Test Circuit**



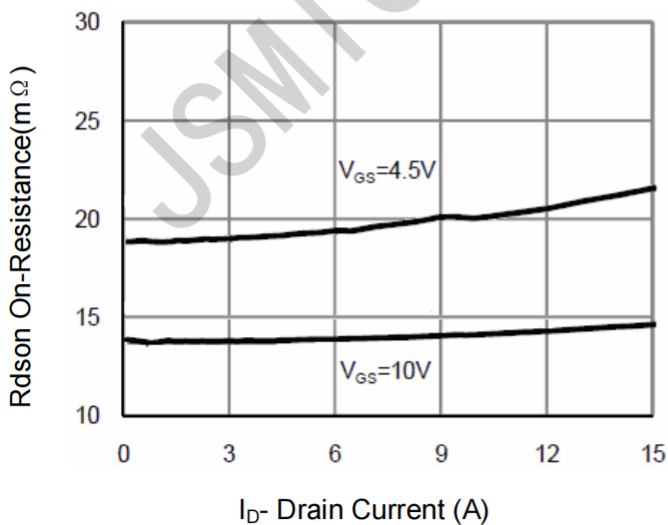
**Figure 2: Switching Waveforms**



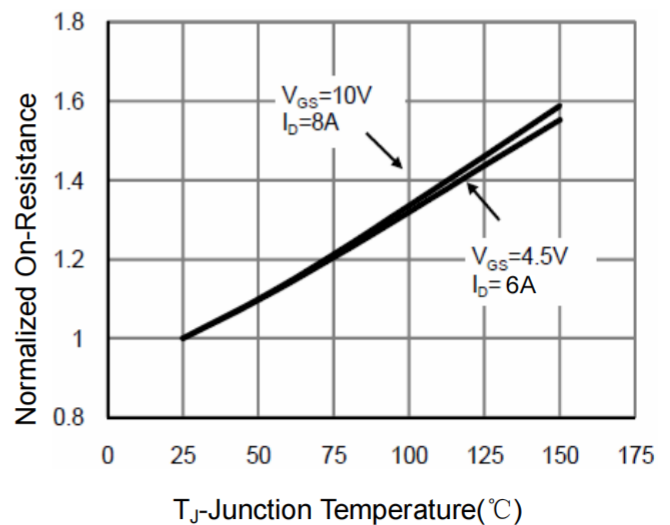
**Figure 3 Output Characteristics**



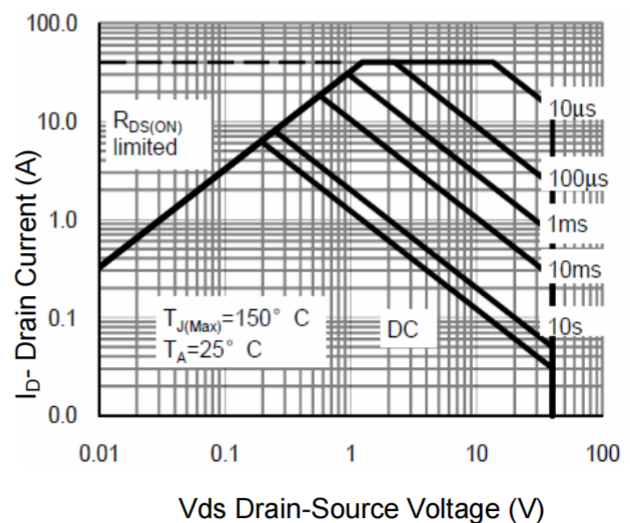
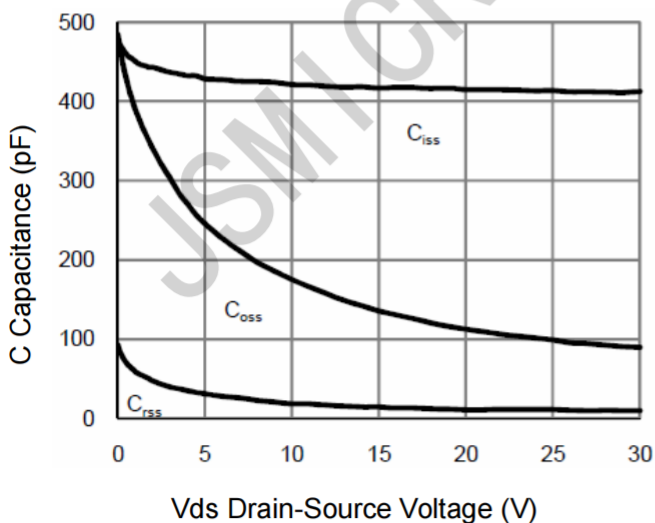
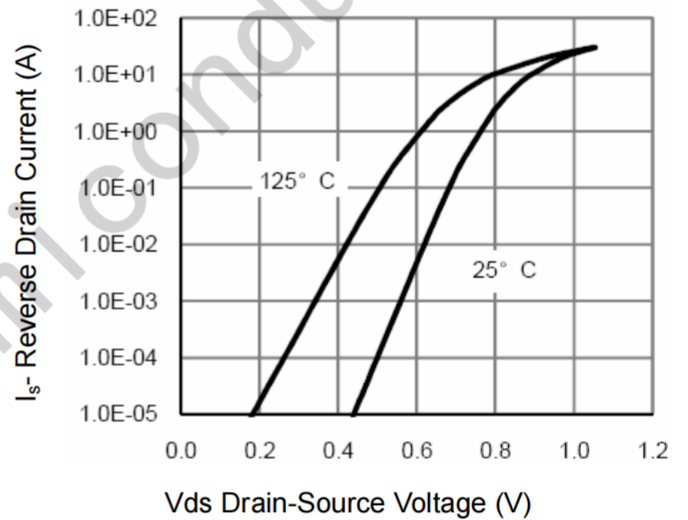
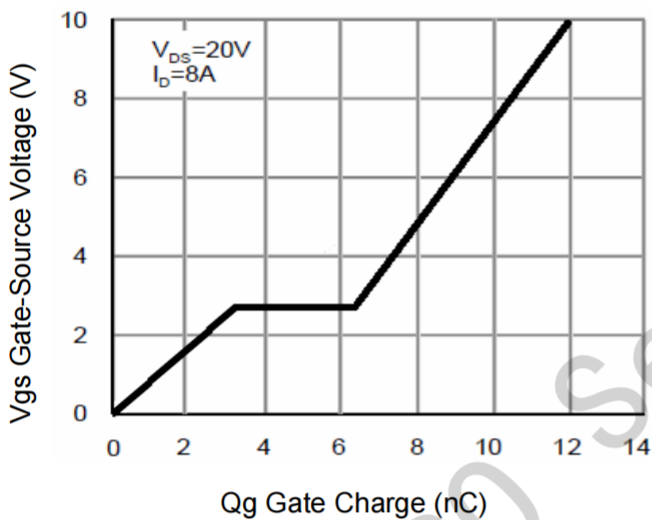
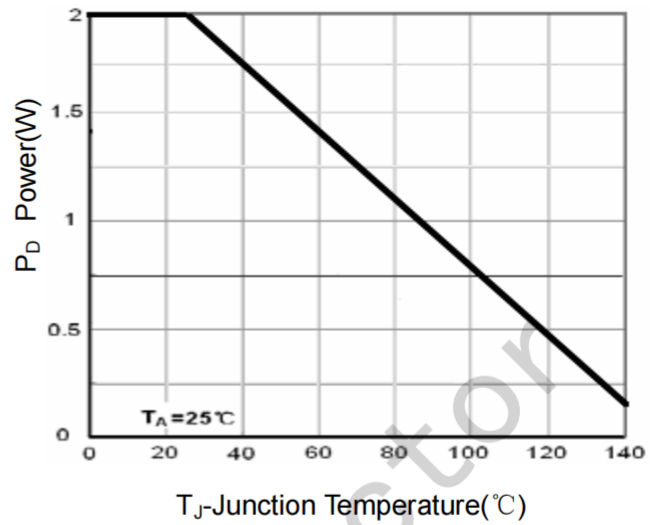
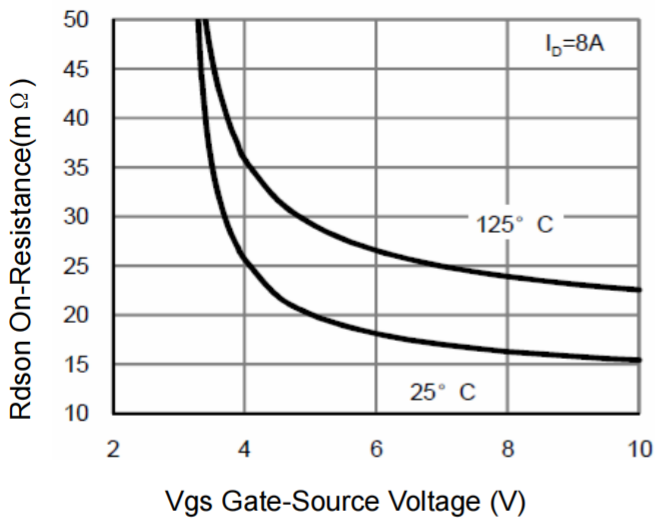
**Figure 4 Transfer Characteristics**

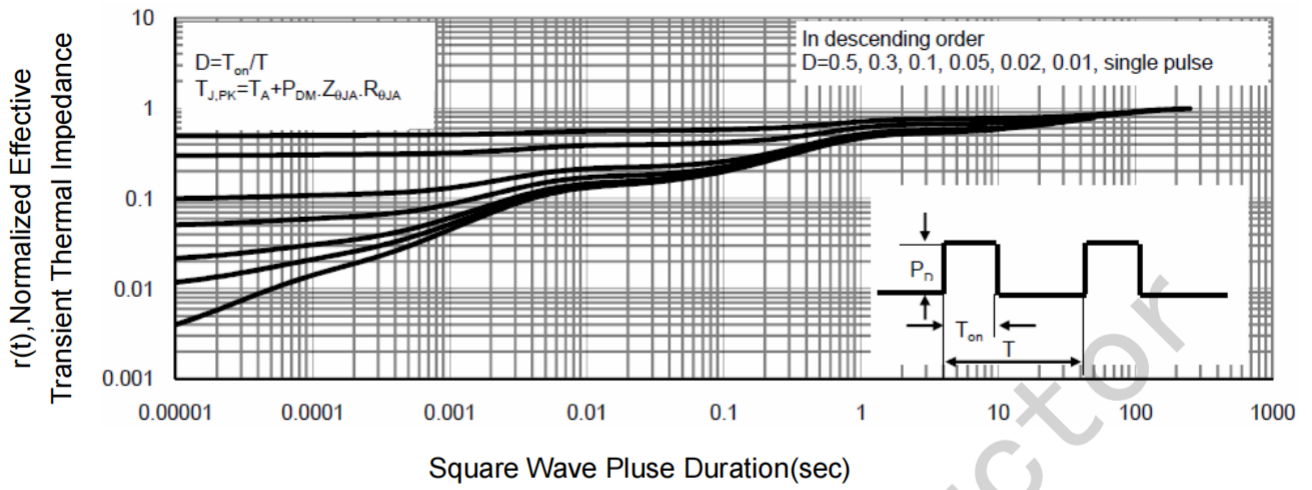


**Figure 5 Drain-Source On-Resistance**



**Figure 6 Drain-Source On-Resistance**





**Figure 13 Normalized Maximum Transient Thermal Impedance**

JSMICRO Semiconductor

**P-CH Electrical Characteristics (T<sub>A</sub>=25°C unless otherwise noted)**

Parameter	Symbol	Condition	Min	Typ	Max	Unit
<b>Off Characteristics</b>						
Drain-Source Breakdown Voltage	BV <sub>DSS</sub>	V <sub>GS</sub> =0V, I <sub>D</sub> =-250μA	-40	-	-	V
Zero Gate Voltage Drain Current	I <sub>DSS</sub>	V <sub>DS</sub> =-40V, V <sub>GS</sub> =0V	-	-	-1	μA
Gate-Body Leakage Current	I <sub>GSS</sub>	V <sub>GS</sub> =±20V, V <sub>DS</sub> =0V	-	-	±100	nA

**On Characteristics (Note 3)**

Gate Threshold Voltage	V <sub>GS(th)</sub>	V <sub>DS</sub> =V <sub>GS</sub> , I <sub>D</sub> =-250μA	-1.1	-1.8	-2.5	V
Drain-Source On-State Resistance	R <sub>DS(ON)</sub>	V <sub>GS</sub> =-10V, I <sub>D</sub> =-7.0A V <sub>GS</sub> =-4.5V, I <sub>D</sub> =-4.0A	-	30 43	35 48	mΩ mΩ
Forward Transconductance	g <sub>FS</sub>	V <sub>DS</sub> =-5V, I <sub>D</sub> =-7.0A	15	-	-	S

**Dynamic Characteristics (Note4)**

Input Capacitance	C <sub>iss</sub>	V <sub>DS</sub> =-20V, V <sub>GS</sub> =0V, F=1.0MHz	-	520	-	PF
Output Capacitance	C <sub>oss</sub>		-	100	-	PF
Reverse Transfer Capacitance	C <sub>rss</sub>		-	65	-	PF

**Switching Characteristics (Note 4)**

Turn-on Delay Time	t <sub>d(on)</sub>	V <sub>DD</sub> =-20V, R <sub>L</sub> =2.3Ω V <sub>GS</sub> =-10V, R <sub>GEN</sub> =6Ω	-	7.5	-	nS
Turn-on Rise Time	t <sub>r</sub>		-	5.5	-	nS
Turn-Off Delay Time	t <sub>d(off)</sub>		-	19	-	nS
Turn-Off Fall Time	t <sub>f</sub>		-	7	-	nS
Total Gate Charge	Q <sub>g</sub>	V <sub>DS</sub> =-20V, I <sub>D</sub> =-7.0A V <sub>GS</sub> =-10V	-	13	-	nC
Gate-Source Charge	Q <sub>gs</sub>		-	3.8	-	nC
Gate-Drain Charge	Q <sub>gd</sub>		-	3.1	-	nC

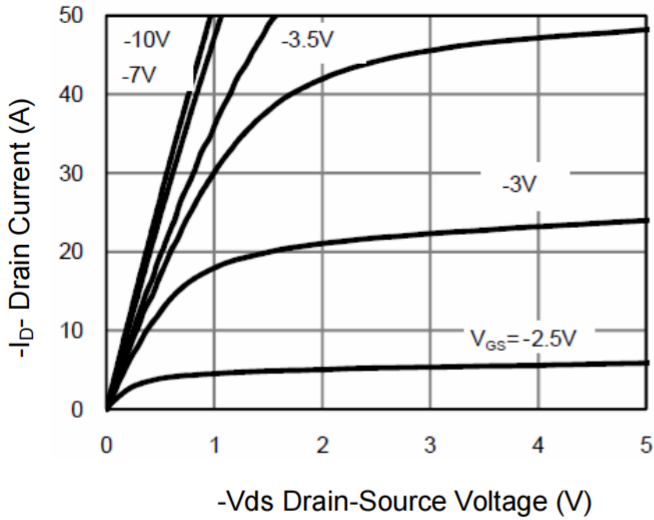
**Drain-Source Diode Characteristics**

Diode Forward Voltage (Note 3)	V <sub>SD</sub>	V <sub>GS</sub> =0V, I <sub>S</sub> =-7.0A	-	0.75	-1.0	V
--------------------------------	-----------------	--	---	------	------	---

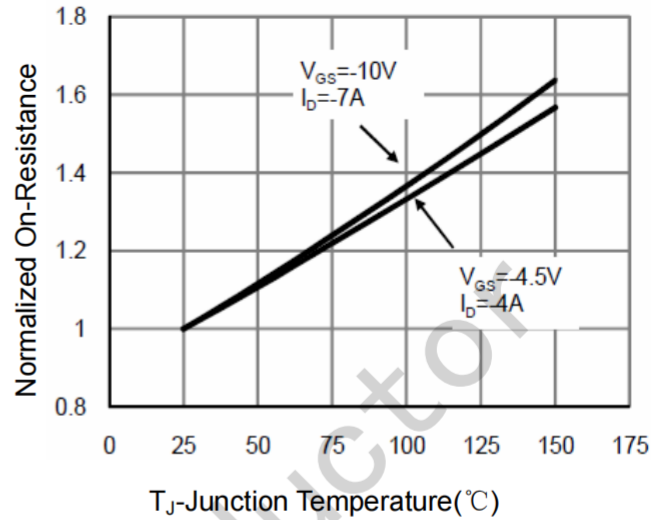
**Notes:**

1. Repetitive Rating: Pulse width limited by maximum junction temperature.
2. Surface Mounted on FR4 Board, t ≤ 10 sec.
3. Pulse Test: Pulse Width ≤ 300μs, Duty Cycle ≤ 2%.
4. Guaranteed by design, not subject to production

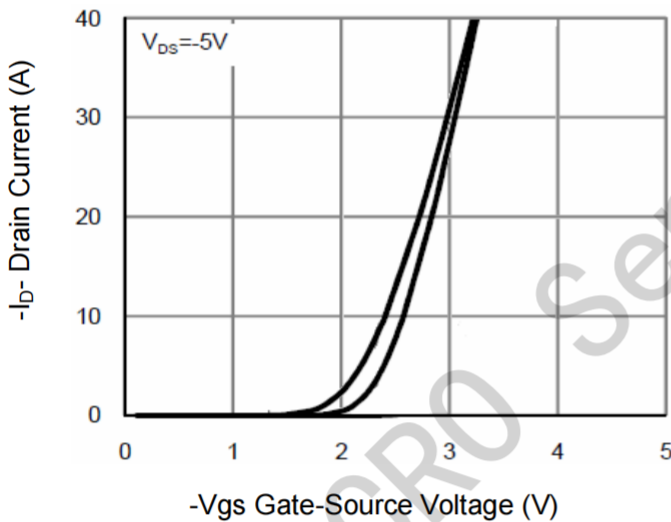
**P- Channel Typical Electrical and Thermal Characteristics (Curves)**



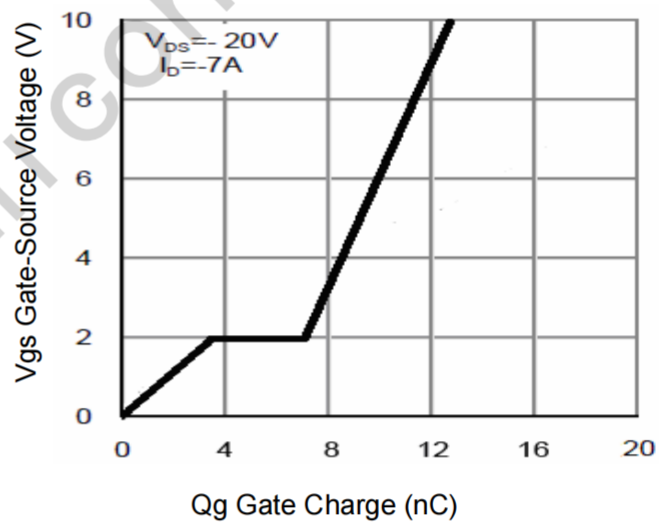
**Figure 1 Output Characteristics**



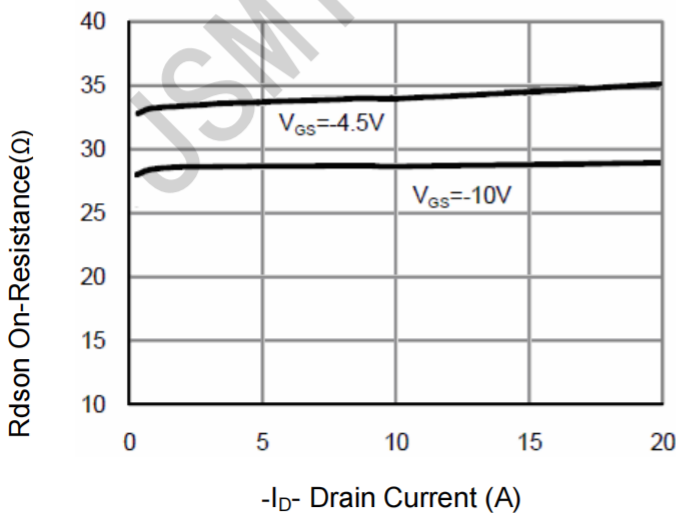
**Figure 4  $R_{dson}$ -Junction Temperature**



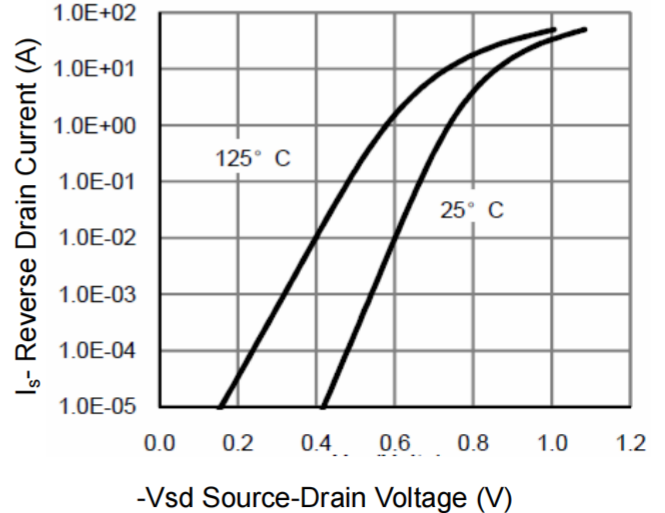
**Figure 2 Transfer Characteristics**



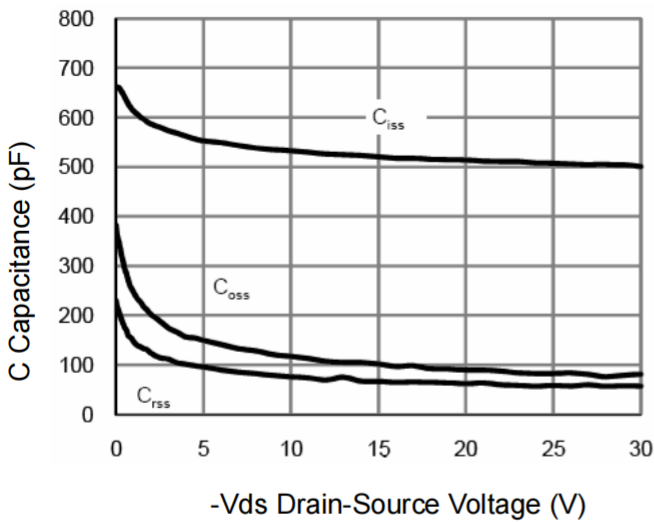
**Figure 5 Gate Charge**



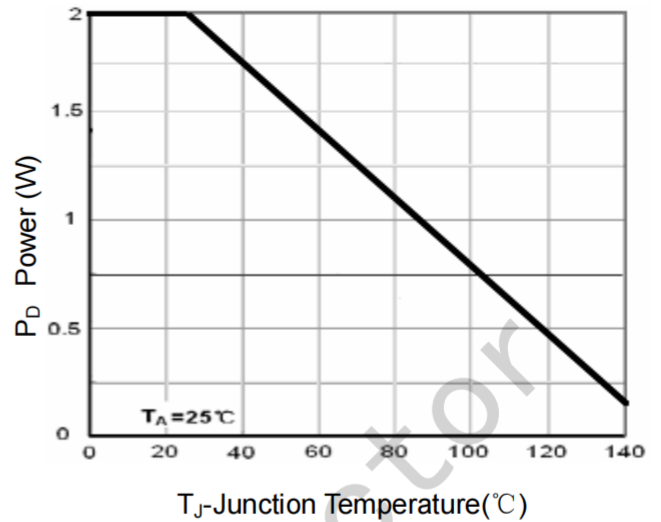
**Figure 3  $R_{dson}$ - Drain Current**



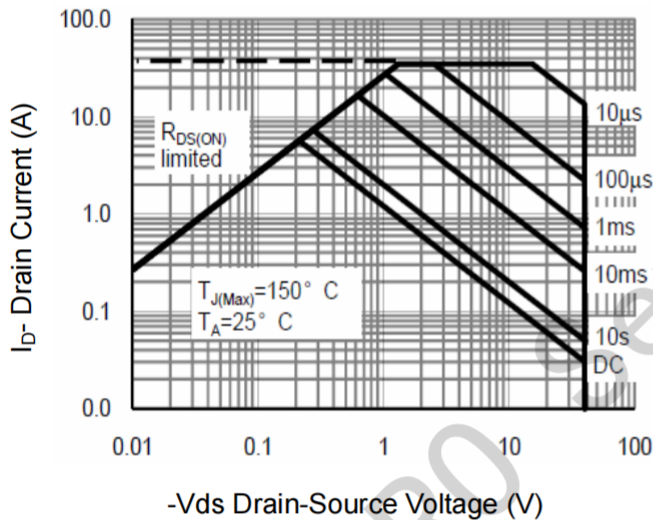
**Figure 6 Source- Drain Diode Forward**



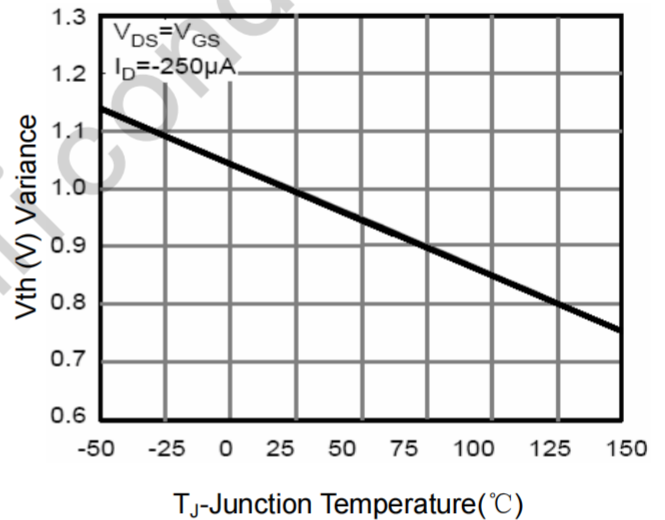
**Figure 7 Capacitance vs Vds**



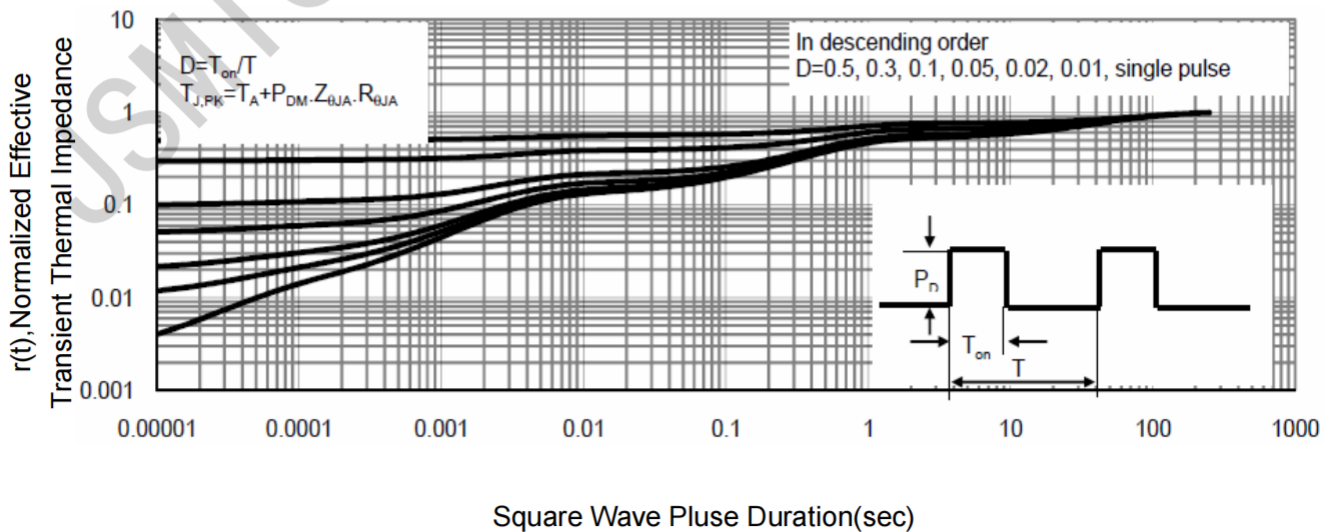
**Figure 9 Power Dissipation**



**Figure 8 Safe Operation Area**



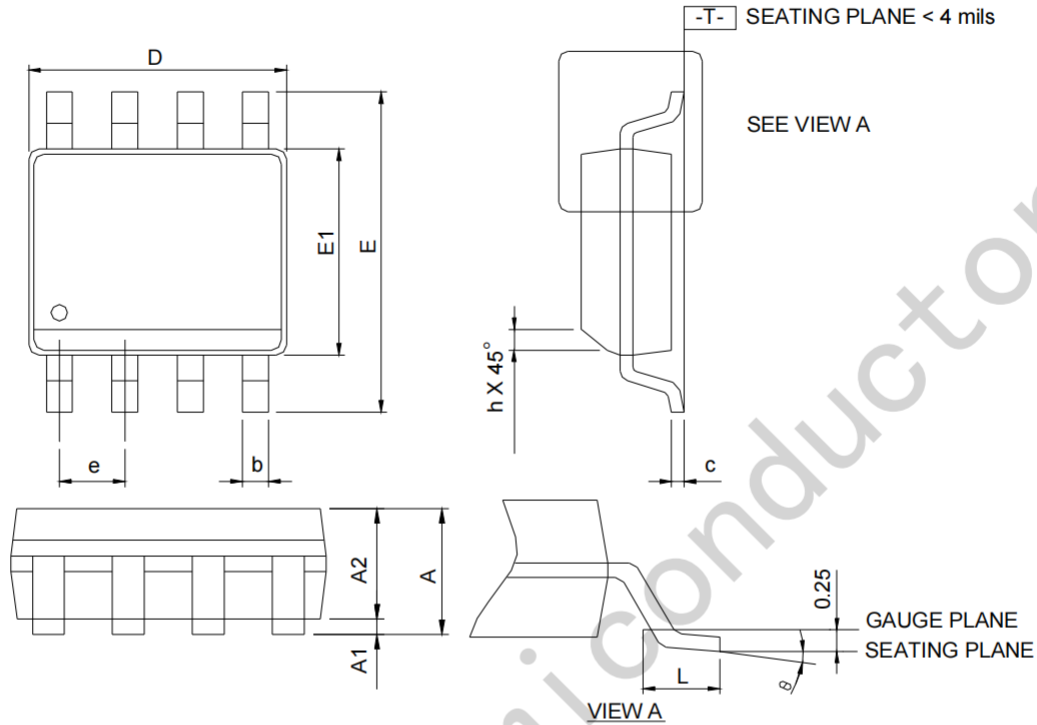
**Figure 10 VGS(th) vs Junction Temperature**



**Figure 11 Normalized Maximum Transient Thermal Impedance**

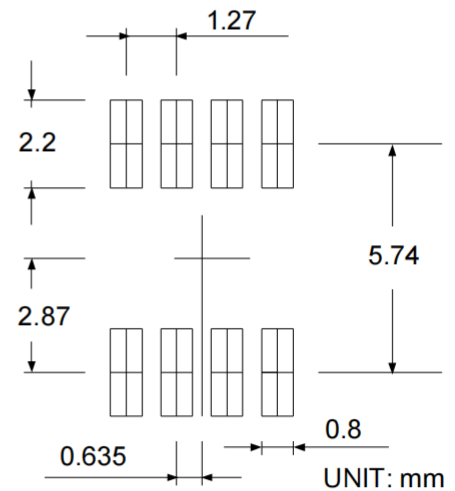
## Package Information

SOP-8



SYMBOLS	SOP-8			
	MILLIMETERS		INCHES	
	MIN.	MAX.	MIN.	MAX.
A	-	1.75	-	0.069
A1	0.10	0.25	0.004	0.010
A2	1.25	-	0.049	-
b	0.31	0.51	0.012	0.020
c	0.17	0.25	0.007	0.010
D	4.80	5.00	0.189	0.197
E	5.80	6.20	0.228	0.244
E1	3.80	4.00	0.150	0.157
e	1.27 BSC		0.050 BSC	
h	0.25	0.50	0.010	0.020
L	0.40	1.27	0.016	0.050
θ	0°	8°	0°	8°

### RECOMMENDED LAND PATTERN



Note: 1. Follow JEDEC MS-012 AA.

2. Dimension "D" does not include mold flash, protrusions or gate burrs. Mold flash, protrusion or gate burrs shall not exceed 6 mil per side.

3. Dimension "E" does not include inter-lead flash or protrusions. Inter-lead flash and protrusions shall not exceed 10 mil per side.