

## Features

- Zero Forward/Reverse Recovery Current
- High Blocking Voltage
- High Frequency Operation
- Positive Temperature Coefficient on  $V_F$
- Temperature Independent Switching Behavior
- High surge current capability
- 100% avalanche tested

## Benefits

- Higher System Efficiency
- Parallel Device Convenience without thermal runaway
- High Temperature Application
- No Switching loss
- Hard Switching & Higher Reliability
- Environmental Protection

## Applications

- Servo Drives
- Solar / Wind Inverters
- AC/DC converters
- DC/DC converters
- Uninterruptable power supplies



TO-247-2



## Maximum Ratings ( $T_C=25^\circ\text{C}$ unless otherwise specified)

Parameter	Symbol	Test conditions	Value	Unit
Peak Repetitive Reverse Voltage	$V_{RRM}$		1200	V
Continuous Forward Current	$I_F$	$T_C=25^\circ\text{C}$	50	A
		$T_C=135^\circ\text{C}$	21	
		$T_C=150^\circ\text{C}$	15	
Non repetitive Forward Surge Current	$I_{FSM}$	$T_C = 25^\circ\text{C}$ , $t_p=10$ ms, Half Sine Pulse	130	A
		$T_C = 110^\circ\text{C}$ , $t_p=10$ ms, Half Sine Pulse	120	
Repetitive peak Forward Surge Current	$I_{FRM}$	$T_C = 25^\circ\text{C}$ , $t_p=10$ ms, Freq = 0.1Hz, 100 cycles, Half Sine Pulse	100	A
		$T_C = 110^\circ\text{C}$ , $t_p=10$ ms, Freq = 0.1Hz, 100 cycles, Half Sine Pulse	90	
Total power dissipation	$P_D$	$T_C=25^\circ\text{C}$	240	W
		$T_C=110^\circ\text{C}$	98	
Single Pulse Avalanche Energy	$E_{AS}$	$L=2\text{mH}$ , $I_{AS}=10\text{A}$	100	mJ
Diode $dv/dt$ ruggedness	$dv/dt$	$V_R = 0-1200\text{V}$	80	V/ns
Operating Junction Temperature	$T_J$		-55 to 175	$^\circ\text{C}$
Storage Temperature	$T_{STG}$		-55 to 175	$^\circ\text{C}$

Stresses exceeding those listed in the Maximum Ratings table may damage the device. If any of these limits are exceeded, device functionality should not be assumed, damage may occur and reliability may be affected.

### Electrical Characteristics

Parameter	Symbol	Test conditions	Min	Typ	Max	Unit
DC Blocking Voltage	$V_{DC}$	$T_J = 25^{\circ}C$	1200			V
Forward Voltage	$V_F$	$I_F = 20A, T_J = 25^{\circ}C$		1.45	1.8	V
		$I_F = 20A, T_J = 125^{\circ}C$		1.8		V
		$I_F = 20A, T_J = 175^{\circ}C$		2.0		V
Reverse Current	$I_R$	$V_R = 1200V, T_J = 25^{\circ}C$		10	200	$\mu A$
		$V_R = 1200V, T_J = 125^{\circ}C$		20	250	$\mu A$
		$V_R = 1200V, T_J = 175^{\circ}C$		50	300	$\mu A$
Total Capacitive Charge	$Q_C$	$V_R = 800V, T_J = 25^{\circ}C$		93		nC
Total Capacitance	C	$V_R = 1V, T_J = 25^{\circ}C,$ Freq = 1MHz		1120		pF
		$V_R = 400V, T_J = 25^{\circ}C,$ Freq = 1MHz		92		
		$V_R = 800V, T_J = 25^{\circ}C,$ Freq = 1MHz		62		

Note: This is a majority carrier diode, so there is no reverse recovery charge

### Thermal Characteristics

Parameter	Symbol	Condition	Min	Typ	Max	Unit
Thermal Resistance	$R_{th(j-c)}$	junction-case		0.6	0.75	$^{\circ}C/W$

### Ordering Information

Order number	Package	Marking	Operation Temperature Range	MSL Grade	Ship,Quantity	Green
SC4D15120H	TO-247-2	SC4D15120H	-55 to 175 $^{\circ}C$	1	TUBE,450	Rohs

**Typical Electrical Curves**

Figure 1. Forward Characteristics

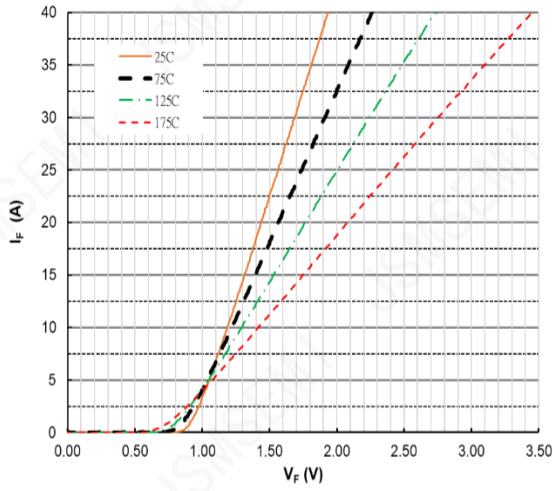

Figure 2. Forward Characteristics

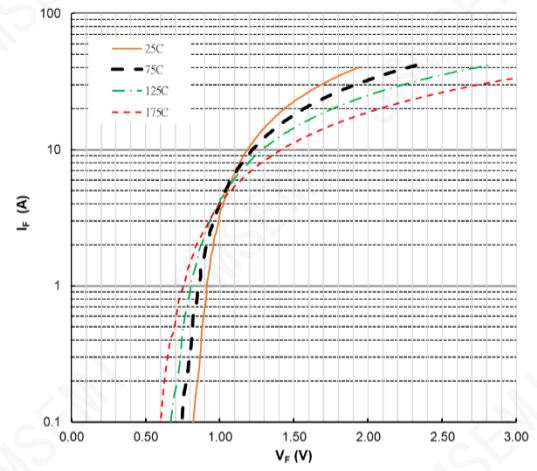

Figure 3. Reverse Characteristics

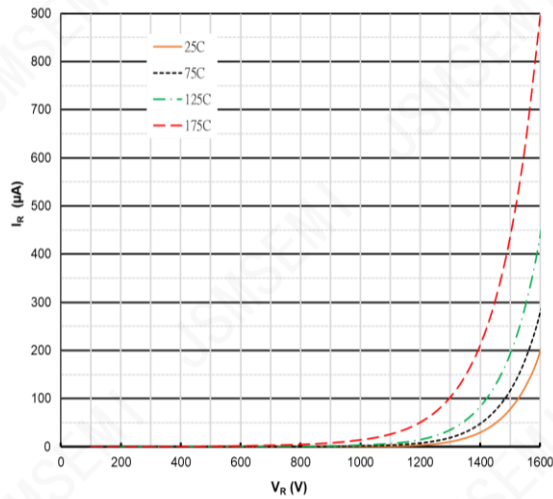

Figure 4. Power Derating

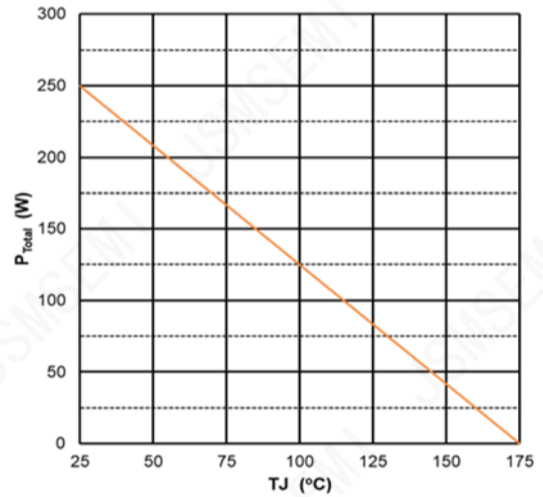

Figure 5. Reverse charge vs. Reverse Voltage

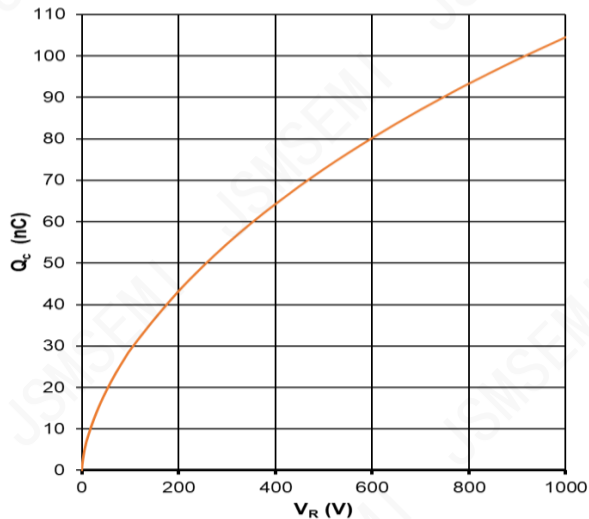
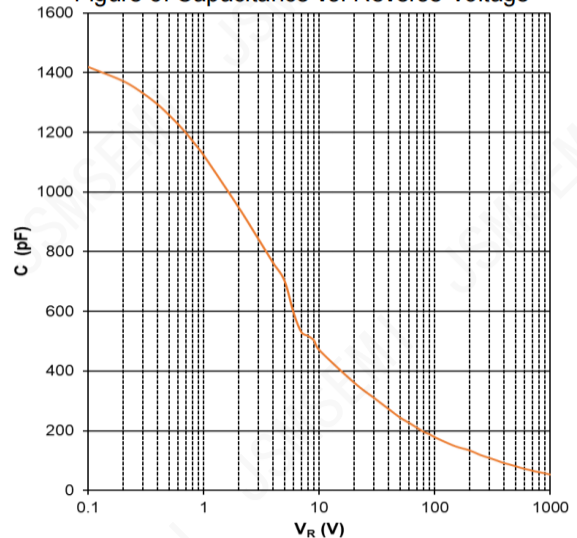
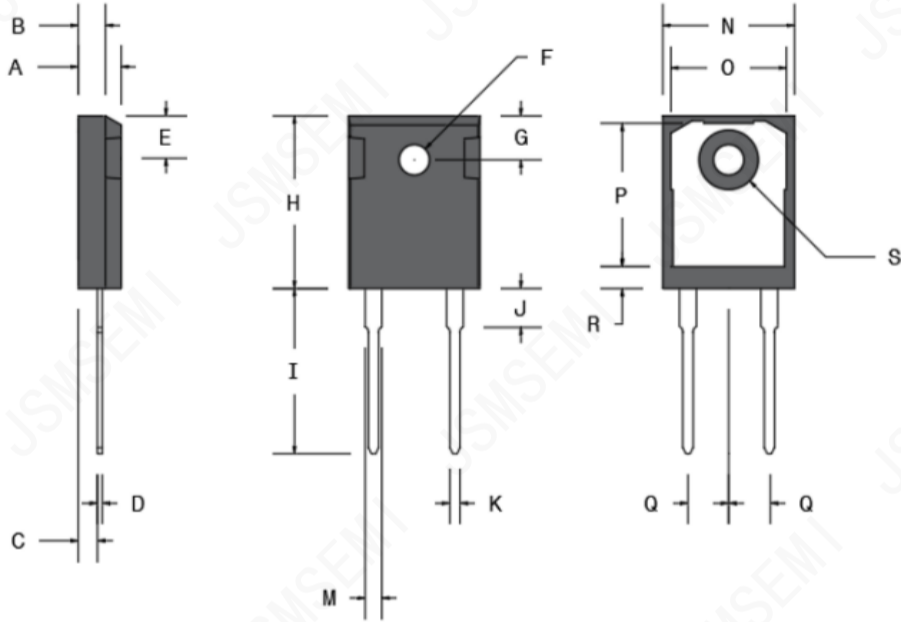

Figure 6. Capacitance vs. Reverse Voltage



## Package Dimensions

(TO-247-2 Package)



SYMBOL	MIN	MAX	MIN	MAX
	[mm]	[mm]	[INCH]	[INCH]
A	4.69	5.31	0.185	0.209
B	1.49	2.49	0.059	0.098
C	2.21	2.59	0.087	0.102
D	0.40	0.79	0.016	0.031
E	5.38	6.20	0.212	0.244
F	3.50	3.81	0.138	0.150
G	6.15BSC		0.242BSC	
H	20.80	21.46	0.819	0.845
I	19.81	20.32	0.780	0.800
J	4.00	4.50	0.157	0.177
K	1.01	1.40	0.040	0.055
L	2.87	3.12	0.113	0.123
M	1.65	2.13	0.065	0.084
N	15.49	16.26	0.610	0.640
O	13.50	14.50	0.531	0.571
P	16.50	17.50	0.650	0.689
Q	5.45BSC		0.215BSC	
R	2.00	2.75	0.079	0.108
S	7.10	7.50	0.280	0.295

## Revision History

Rev.	Change	Date
V1.0	Initial version	2/23/2022

## Important Notice

JSMSEMI Semiconductor (JSMSEMI) PRODUCTS ARE NEITHER DESIGNED NOR INTENDED FOR USE IN MILITARY AND/OR AEROSPACE, AUTOMOTIVE OR MEDICAL DEVICES OR SYSTEMS UNLESS THE SPECIFIC JSMSEMI PRODUCTS ARE SPECIFICALLY DESIGNATED BY JSMSEMI FOR SUCH USE. BUYERS ACKNOWLEDGE AND AGREE THAT ANY SUCH USE OF JSMSEMI PRODUCTS WHICH JSMSEMI HAS NOT DESIGNATED FOR USE IN MILITARY AND/OR AEROSPACE, AUTOMOTIVE OR MEDICAL DEVICES OR SYSTEMS IS SOLELY AT THE BUYER' S RISK.

JSMSEMI assumes no liability for application assistance or customer product design. Customers are responsible for their products and applications using JSMSEMI products.

Resale of JSMSEMI products or services with statements diferent from or beyond the parameters stated by JSMSEMI for that product or service voids all express and any implied warranties for the associated JSMSEMI product or s ervice. JSMSEMI is not responsible or liable for any such statements.

JSMSEMI All Rights Reserved. Information and data in this document are owned by JSMSEMI wholly and may not be edited, reproduced, or redistributed in any way without the express written consent from JSMSEMI.

Any and all information described or contained herein are subject to change without notice due to product/technology improvement, etc. When designing equipment, refer to the "Delivery Specification" for the JSMSEMI product that you intend to use.

For additional information please contact [Kevin@jsmsemi.com](mailto:Kevin@jsmsemi.com) or visit [www.jsmsemi.com](http://www.jsmsemi.com)