

Product Summary

- V_{DS} -30 V
- I_{DS} (at $V_{GS}=-10V$) -40A
- $R_{DS(ON)}$ (at $V_{GS}=-10V$) $\leq 13m\Omega$

Application

- Reverse Battery protection
- Load switch
- Power management
- PWM Application

Package and Pin Configuration

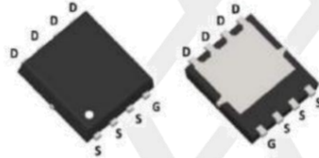
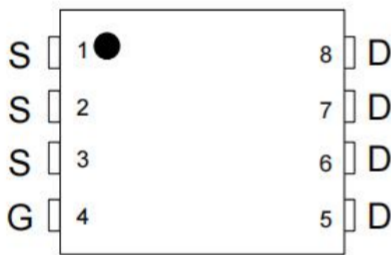

Circuit diagram

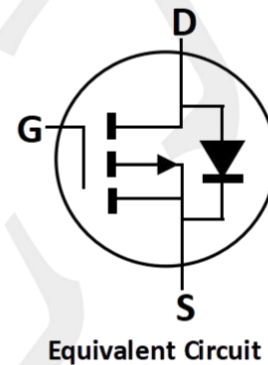

PDFN3X3-8

Absolute Maximum Ratings (T_A=25°C unless otherwise noted)

PARAMETER	SYMBOL	LIMIT	UNIT
Drain-Source Voltage	V_{DS}	-30	V
Gate-Source Voltage	V_{GS}	± 20	V
Continuous Drain Current	I_D	$T_C=25^\circ C$	-40
		$T_C=100^\circ C$	-30
Pulsed Drain Current	I_{DM}	-128	A
Single Pulse Avalanche Energy	EAS	132	mJ
Total Power Dissipation	P_{DTOT}	20	W
Operating Junction Temperature Range	T_J	-55 to +150	°C
Storage Temperature Range	T_{stg}	-55 to +150	°C

Thermal Characteristic

PARAMETER	Symbol	Value	Unit
Junction-to-Ambient Thermal Resistance	$R_{\theta JA}$	63	°C/W
Thermal Resistance Junction-Case	$R_{\theta JC}$	3.2	°C/W

Note : The data tested by surface mounted on a 1 inch2 FR-4 board with 2OZ copper.

Electrical Characteristics (T_A=25°C unless otherwise noted)

PARAMETER	CONDITIONS	SYMBOL	MIN	TYP	MAX	UNIT
Static						
Drain-Source Breakdown Voltage	V _{GS} =0V, I _D =-250μA	BV _{DSS}	-30	--	--	V
Gate-Source Threshold Voltage	V _{DS} =V _{GS} , I _D =-250μA	V _{GS(th)}	-1.0	-1.6	-2.4	V
Gate-Source Leakage	V _{DS} =0V, V _{GS} = ±20V	I _{GSS}	--	--	±100	nA
Zero Gate Voltage Drain Current	V _{DS} = -30V, V _{GS} =0V	I _{DSS}	--	-0.1	-1.0	μA
	V _{DS} =-30V, T _J =55°C		--	-1.0	-5.0	μA
Drain-Source On-State Resistance (Note 1)	V _{GS} = -10V, I _D = -20A	R _{DS(on)}	--	12	17	mΩ
	V _{GS} =-4.5V, I _D = -10A		--	18	25	
Gate Resistance	V _{DS} =0V, V _{GS} =0V, f=1MHz	R _g	--	2.2	--	Ω
Dynamic (Note 2)						
Total Gate Charge (Note 3)	V _{DS} = -20V, I _D = -20A, V _{GS} = -10V	Q _g	--	42	--	nC
Gate-Source Charge (Note 3)		Q _{gs}	--	7.3	--	
Gate-Drain Charge (Note 3)		Q _{gd}	--	8.5	--	
Input Capacitance	V _{DS} = -20V, V _{GS} = 0V, F= 1.0MHz	C _{iss}	--	2700	--	pF
Output Capacitance		C _{oss}	--	350	--	
Reverse Transfer Capacitance		C _{rss}	--	265	--	
Switching						
Turn-On Delay Time (Note 3)	V _{DD} = -20V, I _D = -20A, V _{GS} = -10V, R _G = 3.3Ω	t _{d(on)}	--	10	--	nS
Rise Time (Note 3)		t _r	--	21	--	
Turn-Off Delay Time (Note 3)		t _{d(off)}	--	53	--	
Fall Time (Note 3)		t _f	--	29	--	
Source-Drain Diode Ratings and Characteristics (Note 2)						
Forward Voltage	V _{GS} = 0V, I _F = -1A	V _{SD}	--	-0.7	-1.2	V
Continuous Source Current	Integral reverse diode in the MOSFET	I _S	--	--	-40	A
Pulsed Current (Note 1)		I _{SM}	--	--	-128	A

Notes:

1. Pulse test; pulse width ≤ 300 μS, duty cycle ≤ 2%.
2. Guaranteed by design, not subject to production testing.
3. Independent of operating temperature

Typical Electrical and Thermal Characteristics (Curves)

Figure 1: Output Characteristics

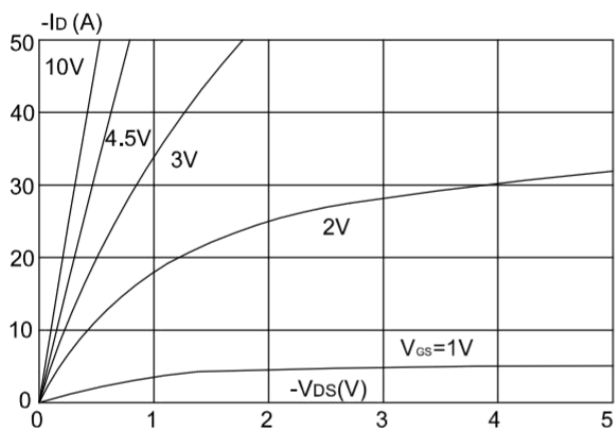

Figure 2: Typical Transfer Characteristics

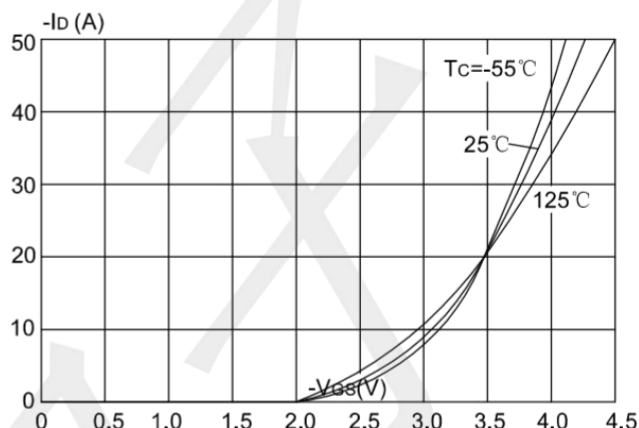

Figure 3: On-resistance vs. Drain Current

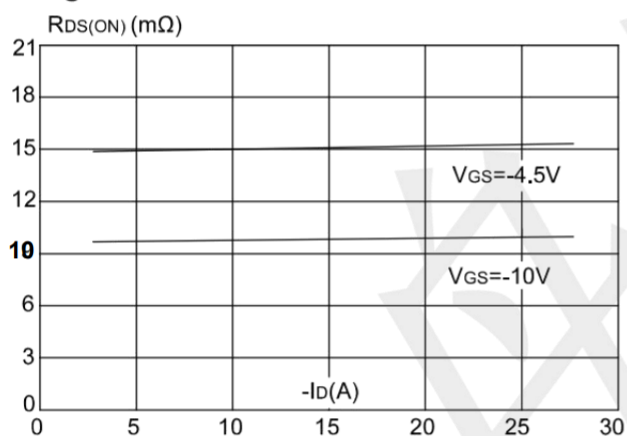

Figure 4: Body Diode Characteristics

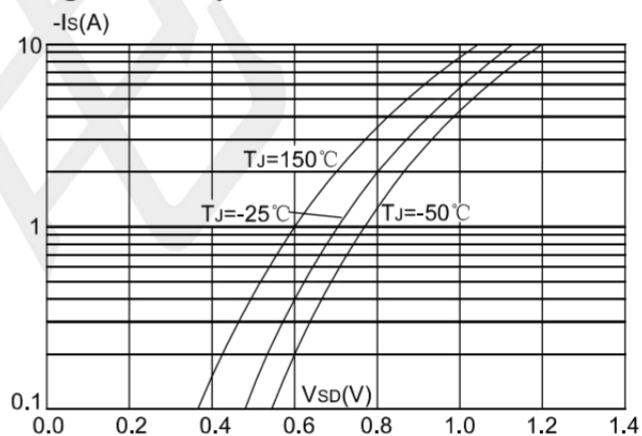

Figure 5: Gate Charge Characteristics

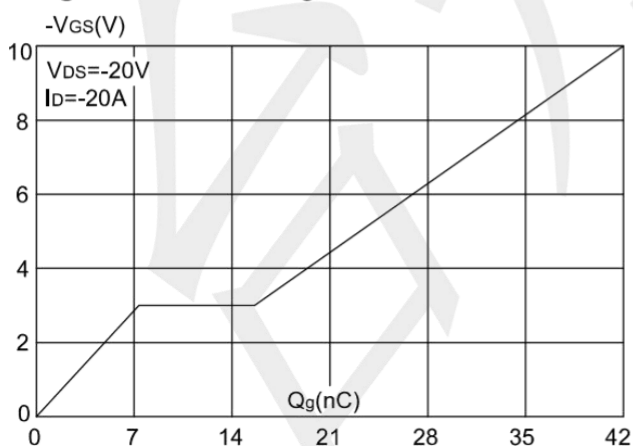
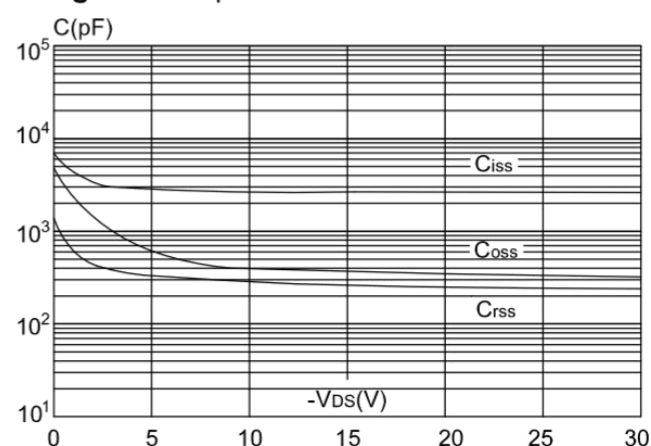

Figure 6: Capacitance Characteristics



Typical Performance Characteristics

Figure 7: Normalized Breakdown Voltage vs. Junction Temperature

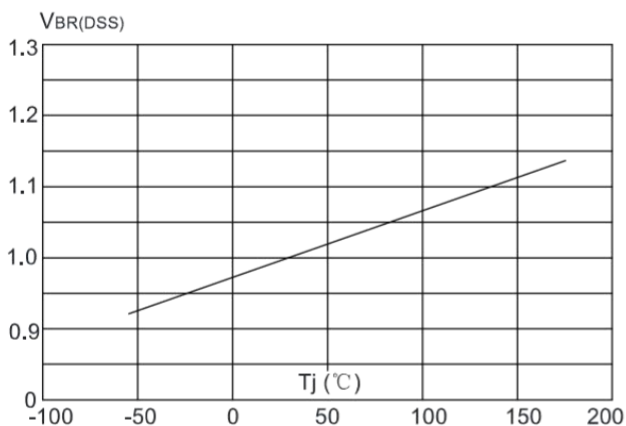

Figure 8: Normalized on Resistance vs. Junction Temperature

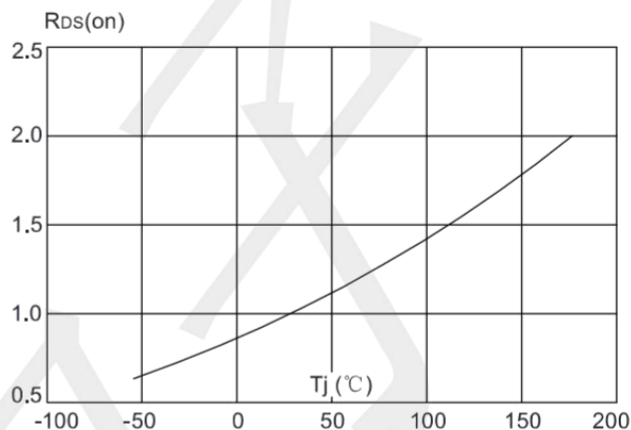

Figure 9: Maximum Safe Operating Area

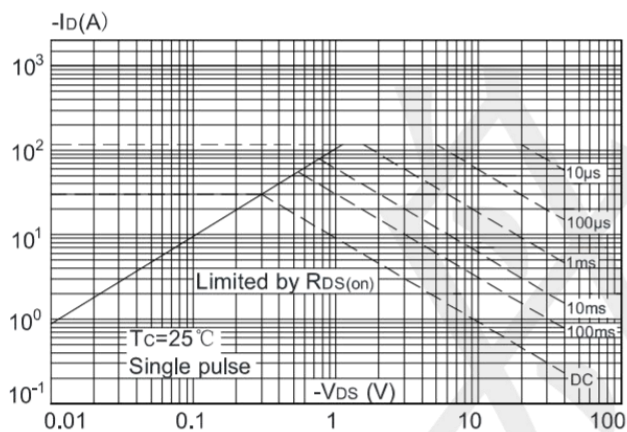

Figure 10: Maximum Continuous Drain Current vs. Case Temperature

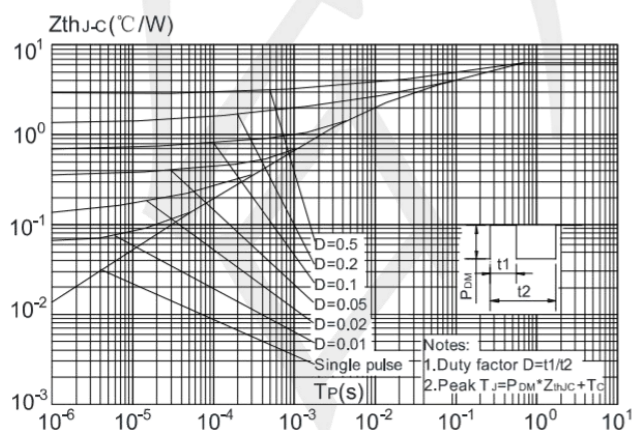
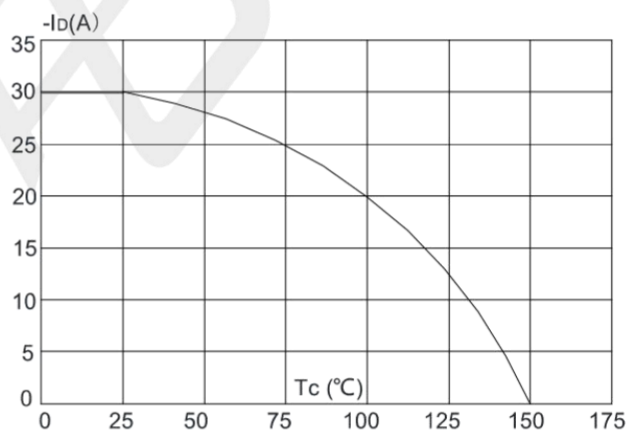
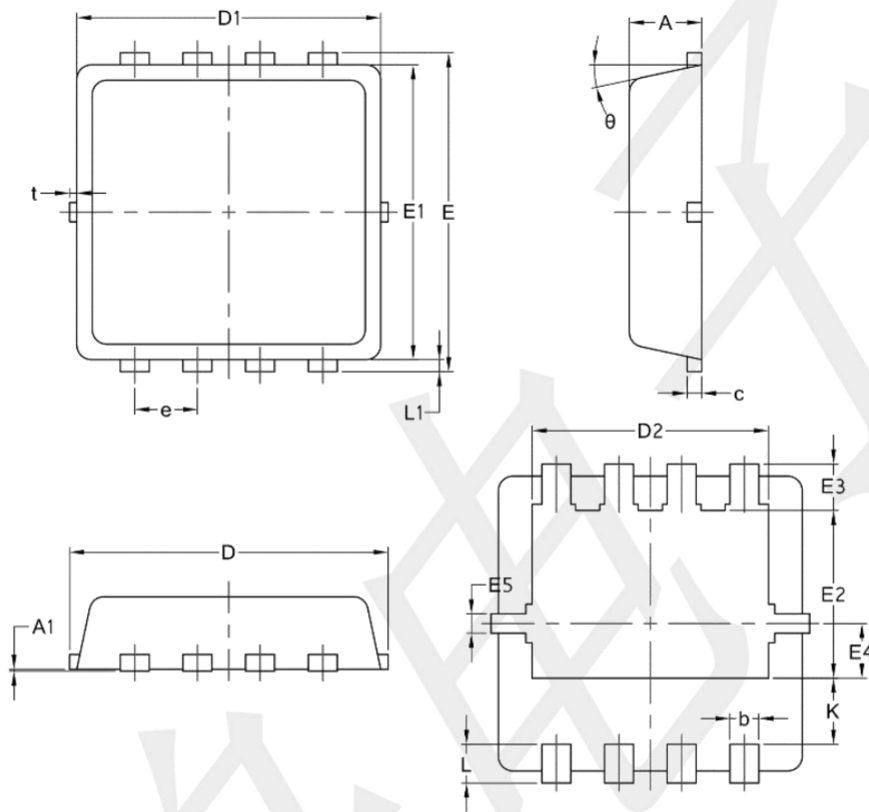

Figure.11: Maximum Effective Transient Thermal Impedance, Junction-to-Case

Package Information

PDFN3X3-8



Symbol	Common		
	mm		
	Mim	Nom	Max
A	0.70	0.75	0.85
A1	/	/	0.05
b	0.20	0.30	0.40
c	0.10	0.152	0.25
D	3.15	3.30	3.45
D1	3.00	3.15	3.25
D2	2.29	2.45	2.65
E	3.15	3.30	3.45
E1	2.90	3.05	3.20
E2	1.54	1.74	1.94
E3	0.28	0.48	0.65
E4	0.37	0.57	0.77
E5	0.10	0.20	0.30
e	0.60	0.65	0.70
K	0.59	0.69	0.89
L	0.30	0.40	0.50
L1	0.06	0.125	0.20
t	0	0.075	0.13
Φ	10	12	14