

Product Summary

- V_{DS} -30 V
- I_{DS} (at $V_{GS}=-10V$) -50A
- $R_{DS(ON)}$ (at $V_{GS}=-10V$) $\leq 9m\Omega$ (Typ)

Application

- Reverse Battery protection
- Load switch
- Power management
- PWM Application

Package and Pin Configuration

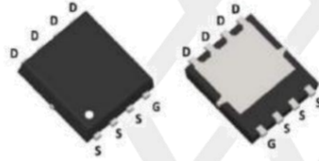
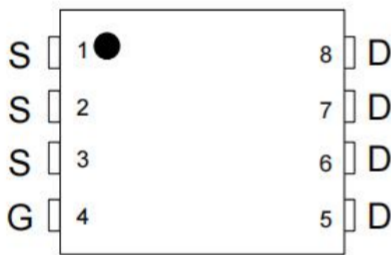

Circuit diagram

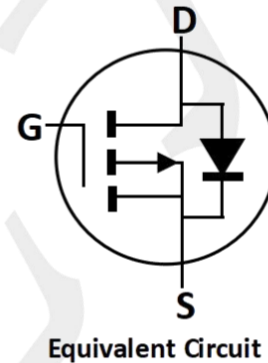

PDFN3X3-8

Absolute Maximum Ratings (T_A=25°C unless otherwise noted)

| PARAMETER | SYMBOL | LIMIT | UNIT |
|--------------------------------------|------------|-------------------|------|
| Drain-Source Voltage | V_{DS} | -30 | V |
| Gate-Source Voltage | V_{GS} | ± 20 | V |
| Continuous Drain Current | I_D | $T_C=25^\circ C$ | -50 |
| | | $T_C=100^\circ C$ | -32 |
| Pulsed Drain Current | I_{DM} | -200 | A |
| Single Pulse Avalanche Energy | EAS | 125 | mJ |
| Total Power Dissipation | P_{DTOT} | 38 | W |
| Operating Junction Temperature Range | T_J | -55 to +150 | °C |
| Storage Temperature Range | T_{stg} | -55 to +150 | °C |

Thermal Characteristic

| PARAMETER | Symbol | Value | Unit |
|--|-----------------|-------|------|
| Junction-to-Ambient Thermal Resistance | $R_{\theta JA}$ | 63 | °C/W |
| Thermal Resistance Junction-Case | $R_{\theta JC}$ | 3.3 | °C/W |

PCB Mount (Note)

Note : The data tested by surface mounted on a 1 inch2 FR-4 board with 2OZ copper.

Electrical Characteristics (T_A=25°C unless otherwise noted)

| PARAMETER | CONDITIONS | SYMBOL | MIN | TYP | MAX | UNIT |
|--|---|---------------------|------|------|------|------|
| Static | | | | | | |
| Drain-Source Breakdown Voltage | V _{GS} =0V, I _D =-250μA | BV _{DSS} | -30 | -- | -- | V |
| Gate-Source Threshold Voltage | V _{DS} =V _{GS} , I _D =-250μA | V _{GS(th)} | -1.0 | -1.5 | -2.0 | V |
| Gate-Source Leakage | V _{DS} =0V, V _{GS} = ±20V | I _{GSS} | -- | -- | ±100 | nA |
| Zero Gate Voltage Drain Current | V _{DS} = -30V, V _{GS} =0V | I _{DSS} | -- | -0.1 | -1.0 | μA |
| | V _{DS} =-30V, T _J =55°C | | -- | -1.0 | -5.0 | μA |
| Drain-Source On-State Resistance (Note 1) | V _{GS} = -10V, I _D = -30A | R _{DS(on)} | -- | 9 | 16 | mΩ |
| | V _{GS} =-4.5V, I _D = -15A | | -- | 15 | 18 | |
| Forward Trans conductance | V _{DS} =-5V, I _D = -18A | g _{fs} | -- | 25 | -- | S |
| Dynamic (Note 2) | | | | | | |
| Total Gate Charge (Note 3) | V _{DS} = -15V, I _D = -15A, V _{GS} = -4.5V | Q _g | -- | 30 | -- | nC |
| Gate-Source Charge (Note 3) | | Q _{gs} | -- | 10 | -- | |
| Gate-Drain Charge (Note 3) | | Q _{gd} | -- | 10.4 | -- | |
| Input Capacitance | V _{DS} = -15V, V _{GS} = 0V, F= 1.0MHz | C _{iss} | -- | 3448 | -- | pF |
| Output Capacitance | | C _{oss} | -- | 508 | -- | |
| Reverse Transfer Capacitance | | C _{rss} | -- | 421 | -- | |
| Switching | | | | | | |
| Turn-On Delay Time (Note 3) | V _{DD} = -15V, I _D = -15A, V _{GS} = -10V, R _G = 3.3Ω | t _{d(on)} | -- | 9.4 | -- | nS |
| Rise Time (Note 3) | | t _r | -- | 10.2 | -- | |
| Turn-Off Delay Time (Note 3) | | t _{d(off)} | -- | 117 | -- | |
| Fall Time (Note 3) | | t _f | -- | 24 | -- | |
| Source-Drain Diode Ratings and Characteristics (Note 2) | | | | | | |
| Forward Voltage | V _{GS} = 0V, I _F = -1A | V _{SD} | -- | -0.7 | -1.2 | V |
| Continuous Source Current | Integral reverse diode in the MOSFET | I _S | -- | -- | -50 | A |
| Pulsed Current (Note 1) | | I _{SM} | -- | -- | -200 | A |

Notes:

1. Pulse test; pulse width ≤ 300 μS, duty cycle ≤ 2%.
2. Guaranteed by design, not subject to production testing.
3. Independent of operating temperature

Typical Performance Characteristics

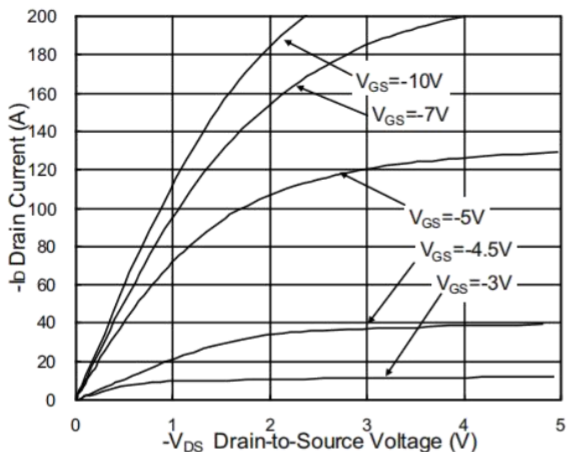

Fig.1 Typical Output Characteristics

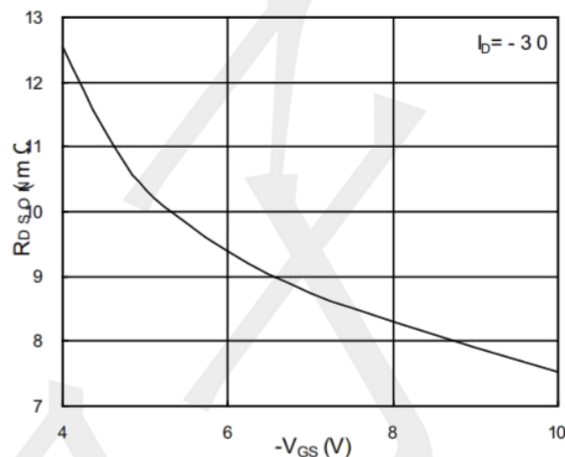

Fig.2 On-Resistance v.s Gate-Source

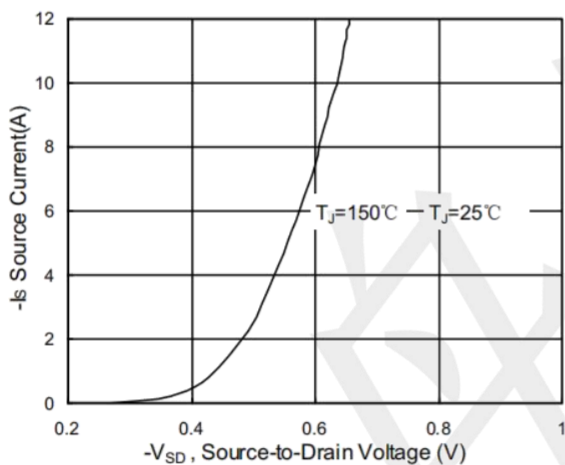

Fig.3 Forward Characteristics Of Reverse

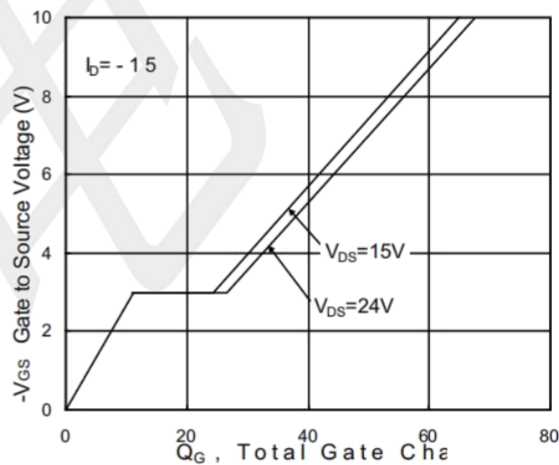

Fig.4 Gate-Charge Characteristics

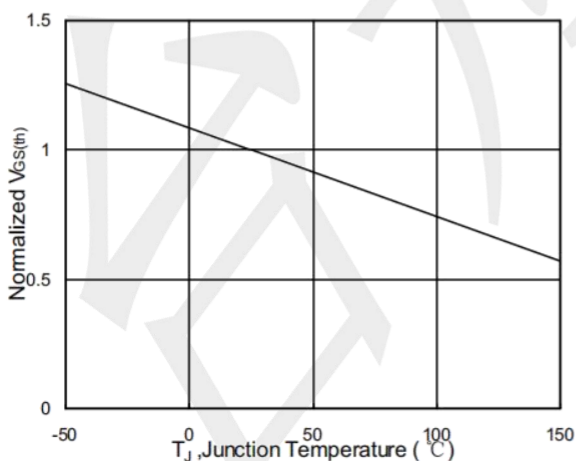

Fig.5 Normalized $V_{GS(th)}$ v.s T_J

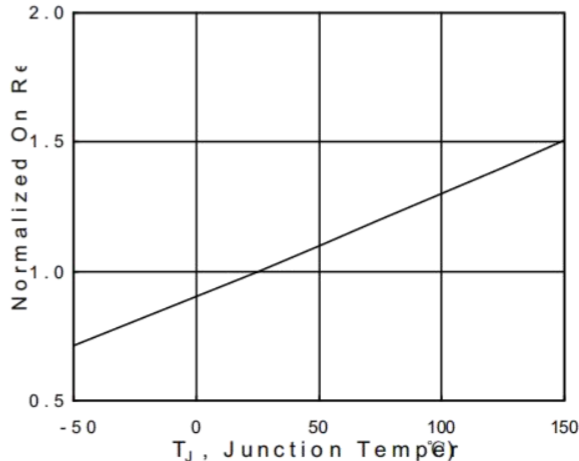

Fig.6 Normalized $R_{DS(on)}$ v.s T_J

Typical Performance Characteristics

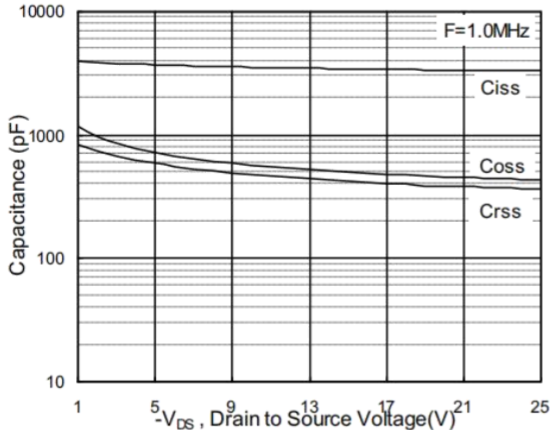

Fig.7 Capacitance

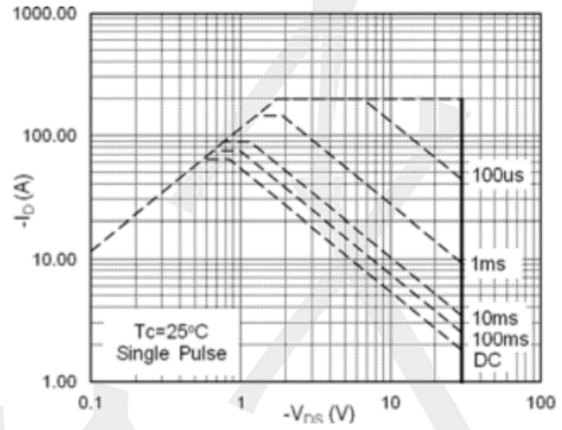

Fig.8 Safe Operating Area

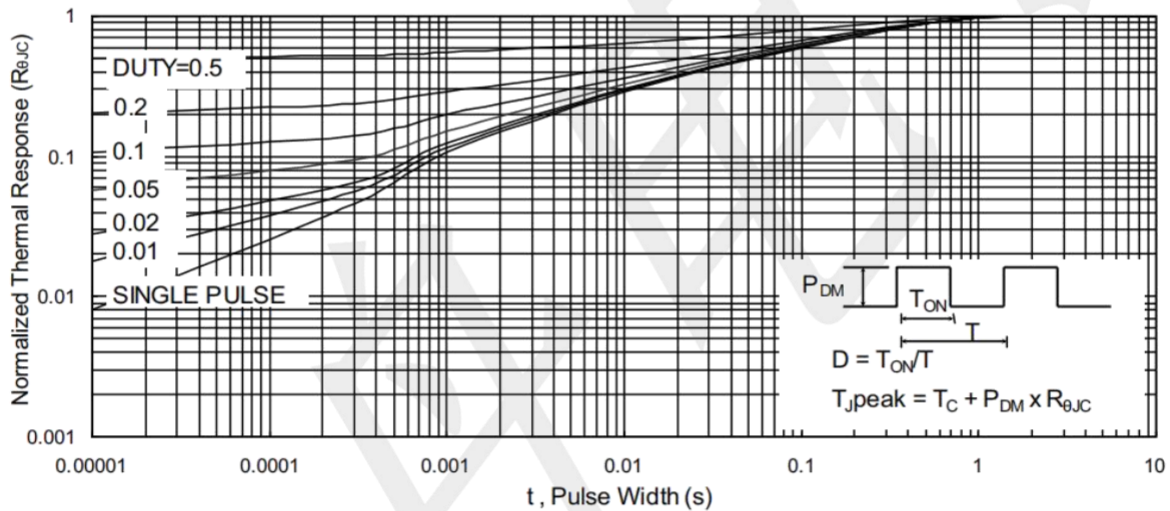

Fig.9 Normalized Maximum Transient Thermal Impedance

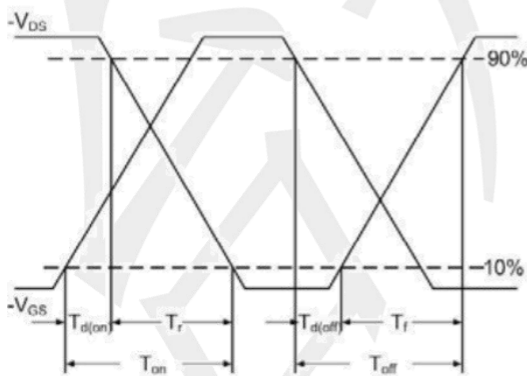

Fig.10 Switching Time Waveform

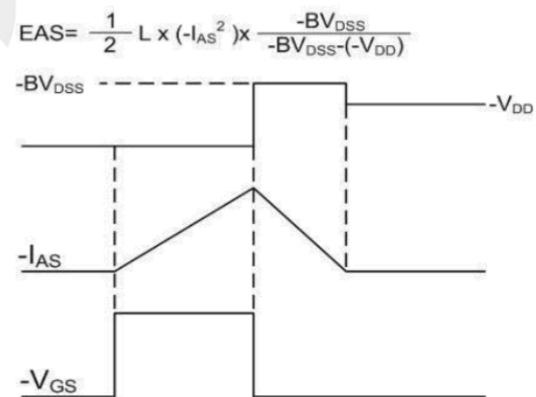
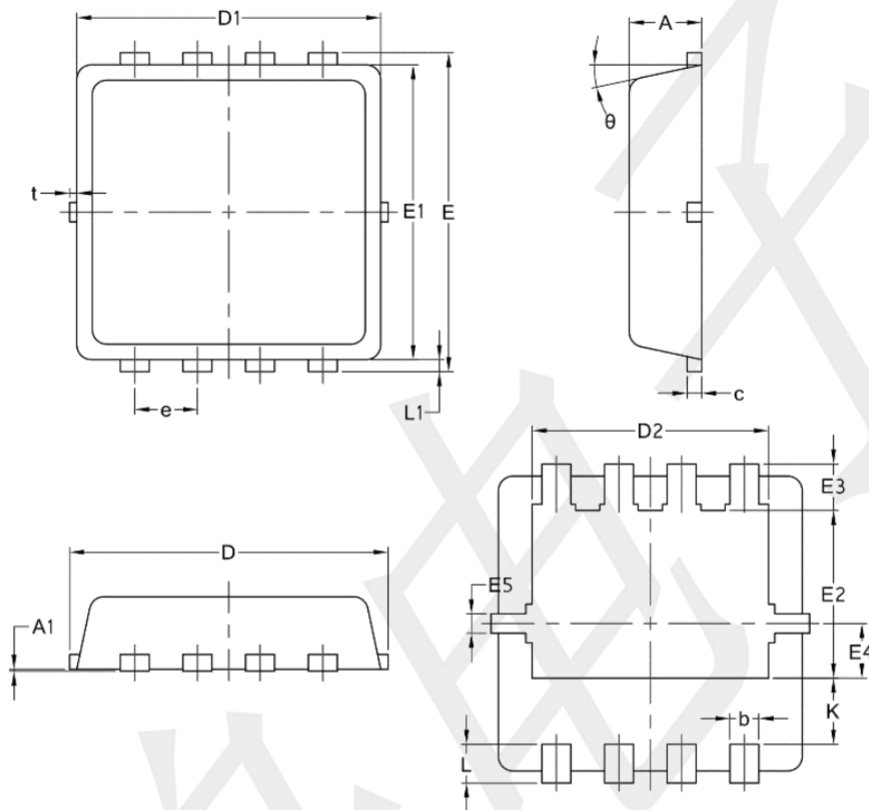

Fig.11 Unclamped Inductive Switching Waveform

Package Information

PDFN3X3-8



| Symbol | Common | | |
|--------|--------|-------|------|
| | mm | | |
| | Mim | Nom | Max |
| A | 0.70 | 0.75 | 0.85 |
| A1 | / | / | 0.05 |
| b | 0.20 | 0.30 | 0.40 |
| c | 0.10 | 0.152 | 0.25 |
| D | 3.15 | 3.30 | 3.45 |
| D1 | 3.00 | 3.15 | 3.25 |
| D2 | 2.29 | 2.45 | 2.65 |
| E | 3.15 | 3.30 | 3.45 |
| E1 | 2.90 | 3.05 | 3.20 |
| E2 | 1.54 | 1.74 | 1.94 |
| E3 | 0.28 | 0.48 | 0.65 |
| E4 | 0.37 | 0.57 | 0.77 |
| E5 | 0.10 | 0.20 | 0.30 |
| e | 0.60 | 0.65 | 0.70 |
| K | 0.59 | 0.69 | 0.89 |
| L | 0.30 | 0.40 | 0.50 |
| L1 | 0.06 | 0.125 | 0.20 |
| t | 0 | 0.075 | 0.13 |
| Φ | 10 | 12 | 14 |