

### Features

- 0.8 $\mu$ A Current at no Load(TYP.)
- $\pm 2\%$  Output Accuracy
- 300mA Output Current
- Compact package: DFN1X1-4 & SOT23-5 & SO23-3L & SO23

### Applications

- Portable consumer equipments
- Radio control systems
- Wireless Communication Equipments
- Ultra Low Power Micro controller

### PIN CONFIGURATION

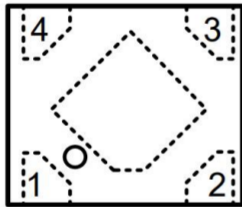

DFN1X1-4

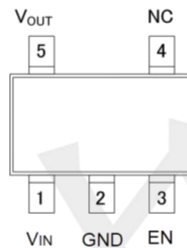

SOT23-5

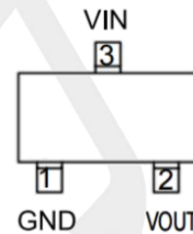

SOT23-3L & SOT23

Pin Number				Pin Name	Pin Function
DFN1X1-4	SOT23-5	SOT23-3L	SOT23		
1	5	2	2	$V_{OUT}$	Output Pin
2	2	1	1	$V_{SS}/GND$	Ground
3	3	--	--	EN	Chip Enable Pin
4	1	3	3	$V_{IN}$	Power Input Pin
--	4	--	--	NC	No Internal Connection

### Ordering Information

TP132LC18S5-2

PACKAGE TYPE

D4:DFN1X1-4

S5:SOT23-5

S3L:SOT23-3L

S3:SOT23

OUTPUT VOLTAGE

12: 1.2V    15: 1.5V

18: 1.8V    25: 2.5V

28: 2.8V    30: 3.0V

33: 3.3V    36: 3.6V

Example: TP132LC18S5-2

→ 1.8V Version, in SOT23-5 Package & Tape & Reel Packing Type

### Absolute Maximum Ratings

over operating free-air temperature range (unless otherwise noted)

		MIN	MAX	UNIT
VIN	Continuous input voltage range	-0.3	7	V
VOU	Output voltage range	-0.3	VIN+0.3	
Current	Maximum output current	Internally limited		mA
Temperature	Operating Temperature, Topr	-40	+85	°C
	Storage, Tstg	-40	+150	
	Welding temperature and time, Tsolder	+260, 10s		
Power Dissipation	Pd DFN1X1-4	400		mW
	Pd SOT23-5	300		
	Pd SOT23-3L	250		

### BLOCK DIAGRAM

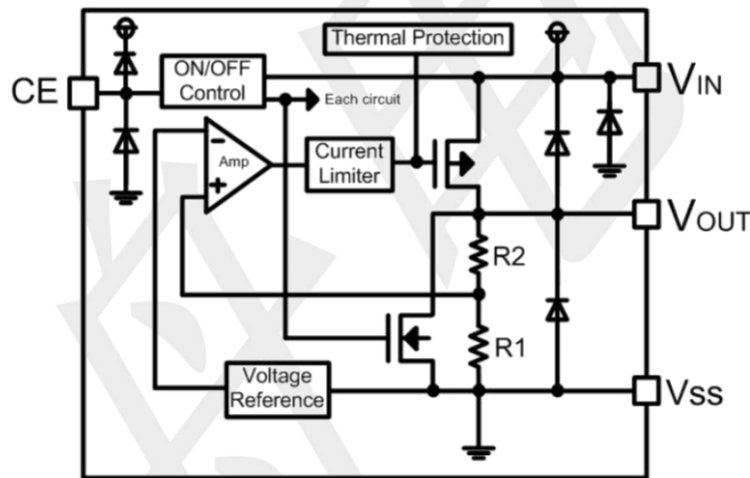

### Typical Application Circuit

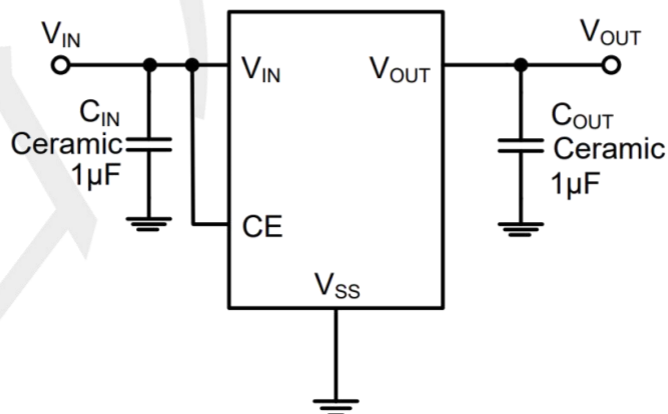

### Electrical Characteristics ( TA=25°C, unless otherwise specified)

PARAMETER	SYMBOL	CONDITIONS	MIN.	TYP.	MAX.	UNITS	
Input Voltage	$V_{IN}$	--	1.8	--	7.0	V	
Output Voltage	$V_{OUT}$	--	1.2	--	3.6	V	
DC Output Accuracy	--	$I_{OUT}=1mA$	-2	--	2	%	
Output Current	$I_{OUT}$	$V_{IN}=1.8V$	150	--	--	mA	
		$V_{IN}=4.3V$	350	--	--		
Dropout Voltage	$V_{dif}^{(2)}$	$I_{OUT}=100mA, V_{OUT}=3.0V$	--	110	--	mV	
Supply Current	$I_{SS}$	$I_{OUT}=0$	0.45	0.8	1.3	$\mu A$	
Standby Current	$I_{STBY}$	$CE=V_{SS}$	--	--	0.1	$\mu A$	
Load Regulation	$\Delta V_{OUT}$	$V_{IN}=V_{OUT}+1V$ $1mA \leq I_{OUT} \leq 100mA$	--	5	--	mV	
Line Regulation	$\frac{\Delta V_{OUT}}{V_{OUT} \times \Delta V_{IN}}$	$I_{OUT}=10mA$ $V_{OUT}+1V \leq V_{IN} \leq 6V$	--	0.03	0.2	%/V	
Temperature Coefficient	$\frac{\Delta V_{OUT}}{V_{OUT} \times \Delta T_A}$	$I_{OUT}=10mA$ $-40^\circ C < T_A < 85^\circ C$	--	50	--	ppm	
Output Current Limit	$I_{LIM}$	$V_{OUT}=90\% \times V_{OUT}$ ( $V_{OUT} \geq 3.0V$ )	350	--	--	mA	
Short Current	$I_{SHORT}$	$V_{OUT}=V_{SS}$	--	10	--	mA	
Power Supply Rejection Ratio	PSRR	$I_{OUT}=50mA$	100Hz	--	65	--	dB
			1kHz	--	70	--	
			10kHz	--	50	--	
			100kHz	--	35	--	
CE "High" Voltage	$V_{CE}^{\text{"H"}}$	--	1.5	--	$V_{IN}$	V	
CE "Low" Voltage	$V_{CE}^{\text{"L"}}$	--	--	--	0.3	V	
COU <sub>T</sub> Auto-Discharge Resistance	$R_{DISCHRG}$	$V_{IN}=5V, V_{OUT}=3.0V$ $V_{CE}=V_{SS}$	--	200	--	$\Omega$	

Note:

- Test condition: the device is mounted on FR-4 substrate PC board, with minimum recommended pad layout.
- $V_{dif}$  :The Difference Of Output Voltage And Input Voltage When Input Voltage Is Decreased Gradually Till Output Voltage Equals To 98% Of  $V_{OUT}$  .

### Typical Operating Characteristics (25 °C, unless otherwise noted)

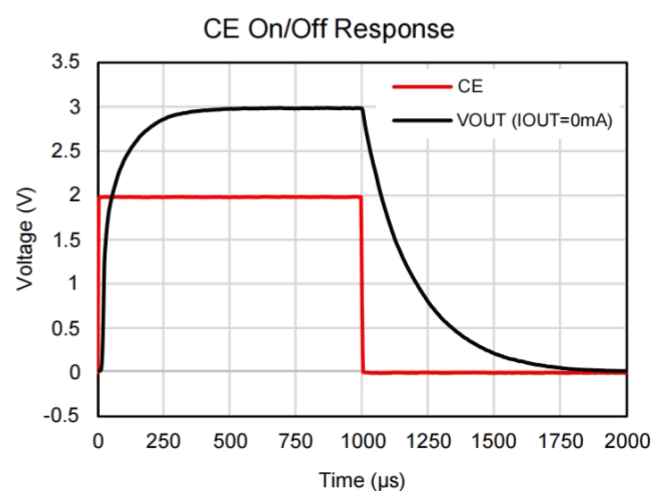
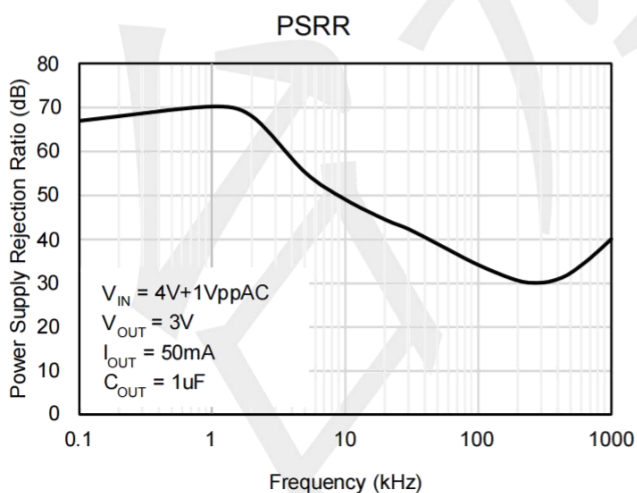
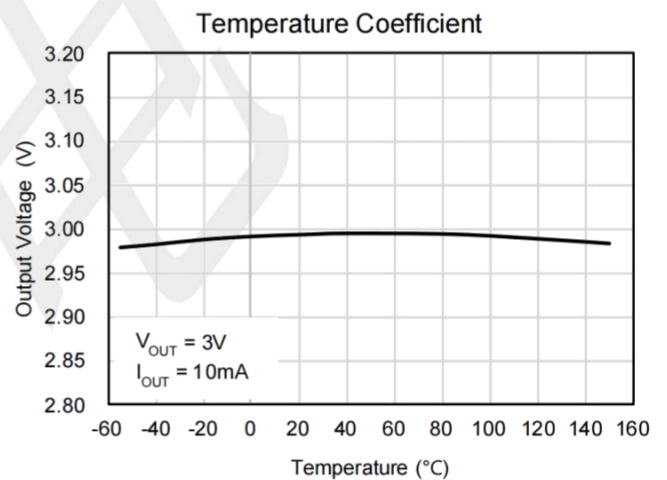
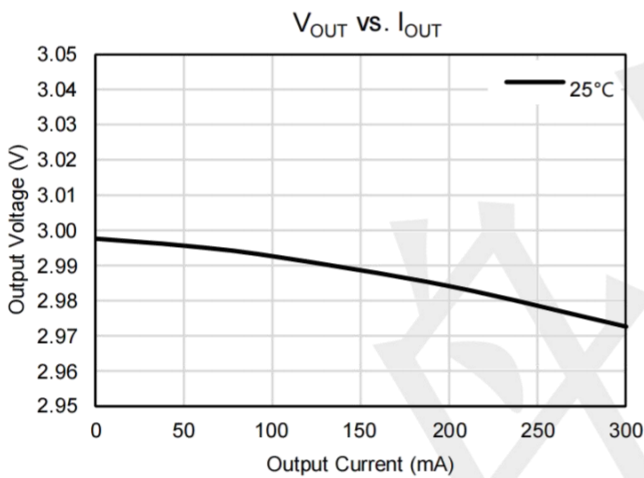
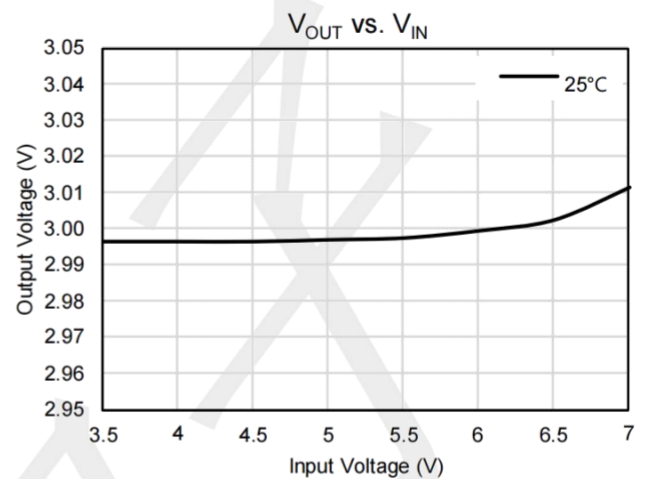
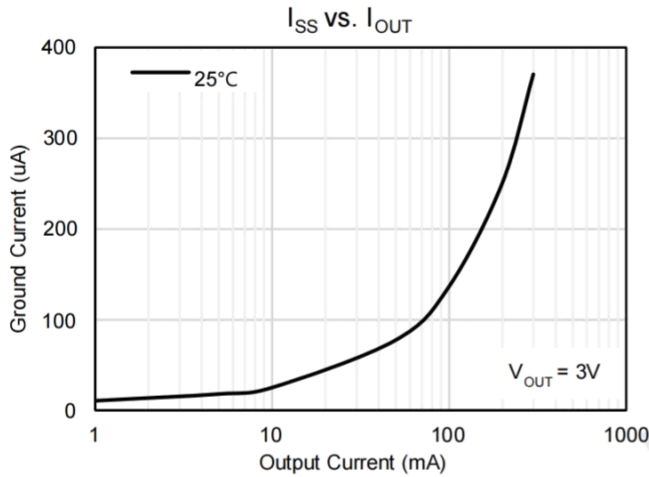

### Typical Operating Characteristics (25 °C, unless otherwise noted)

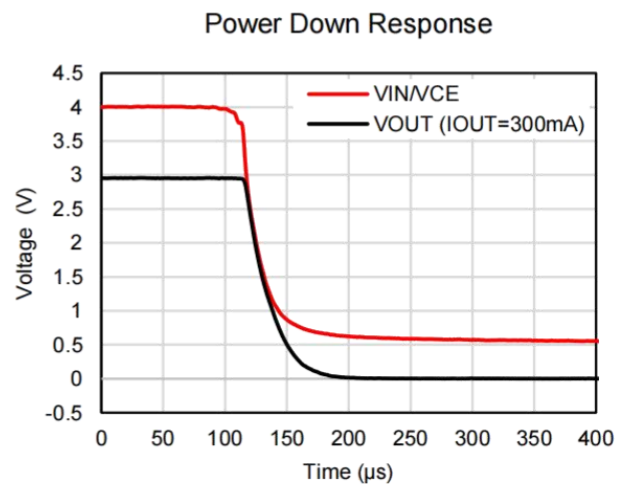
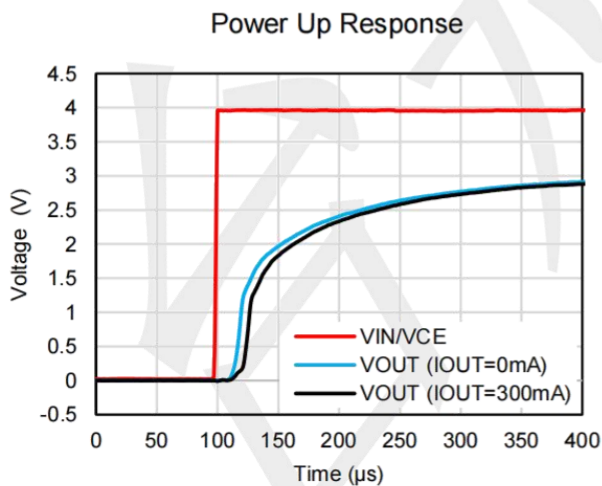
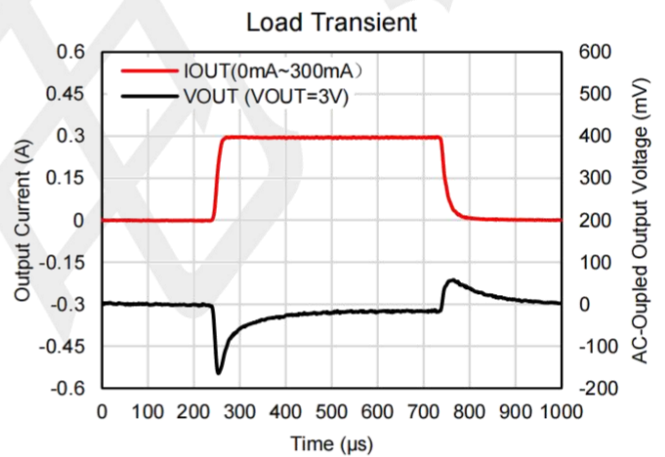
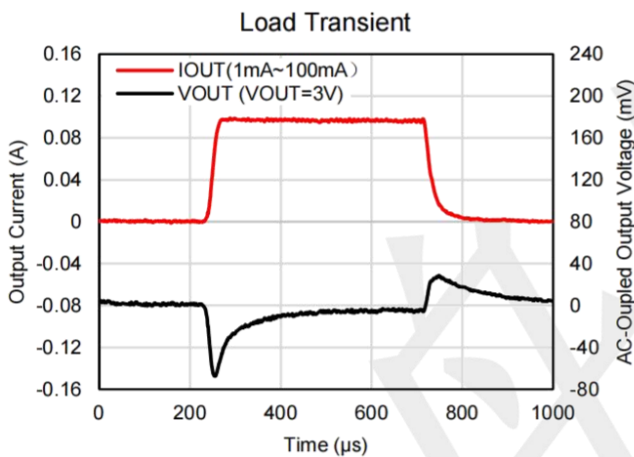
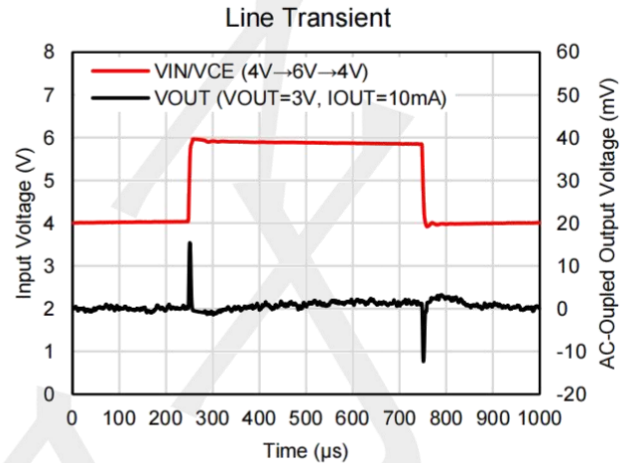
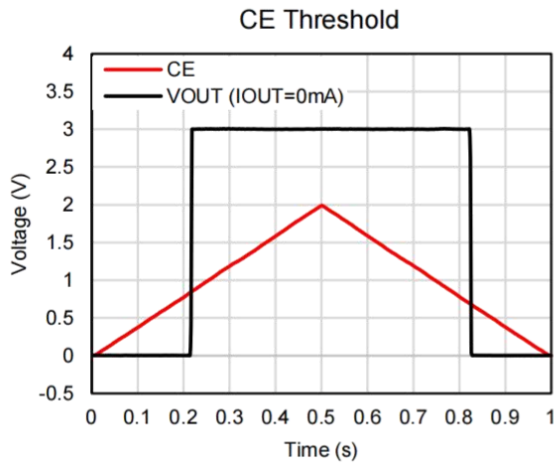

**Package Outline Dimensions (unit: mm)**

DFN1X1-4

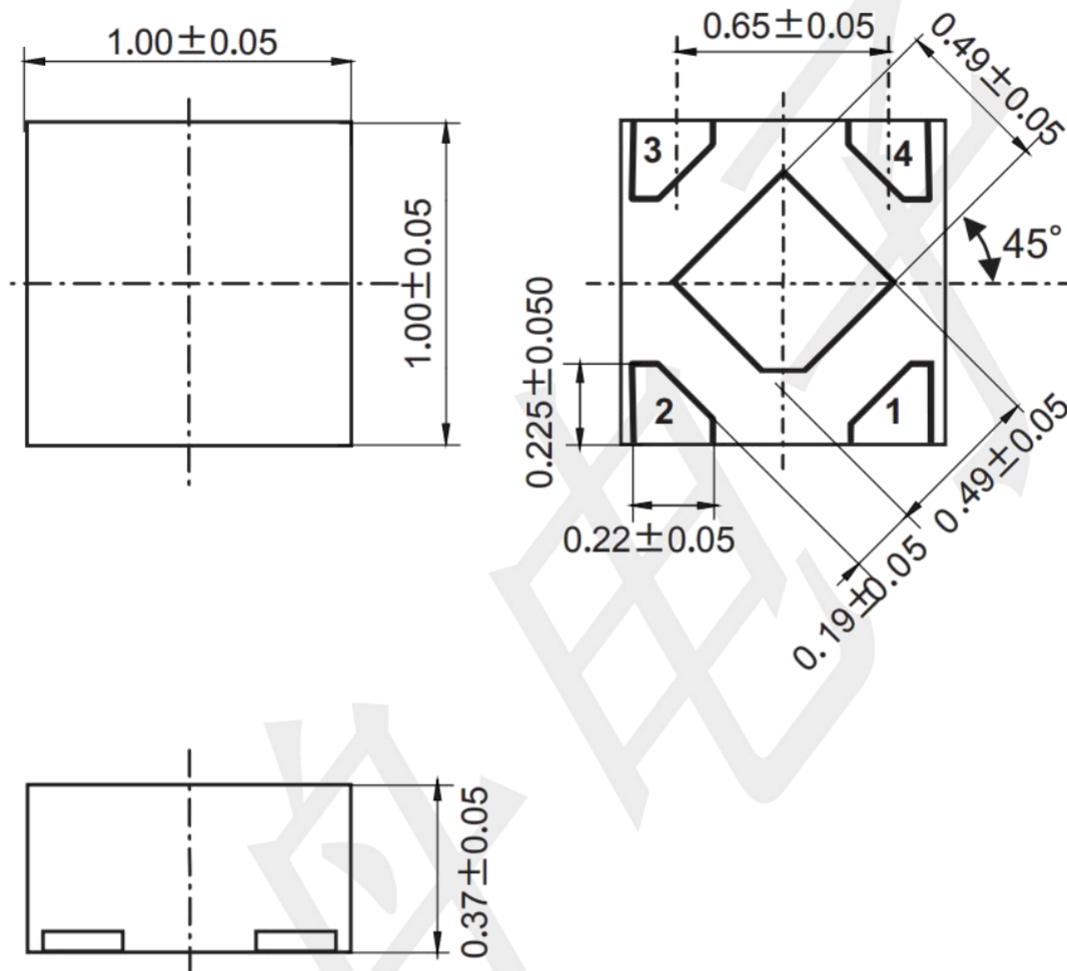

**Mounting Pad Layout (unit: mm)**

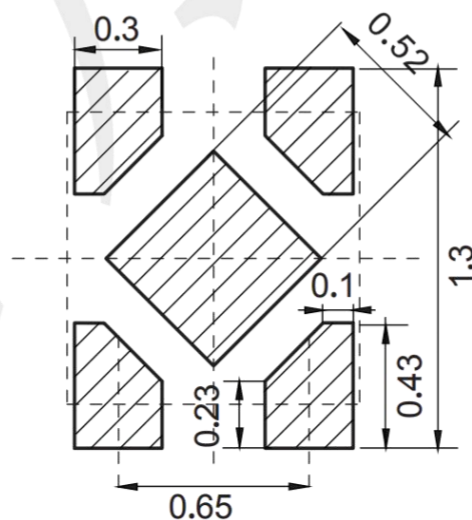

**Package Outline Dimensions (unit: mm)**

SOT23-5

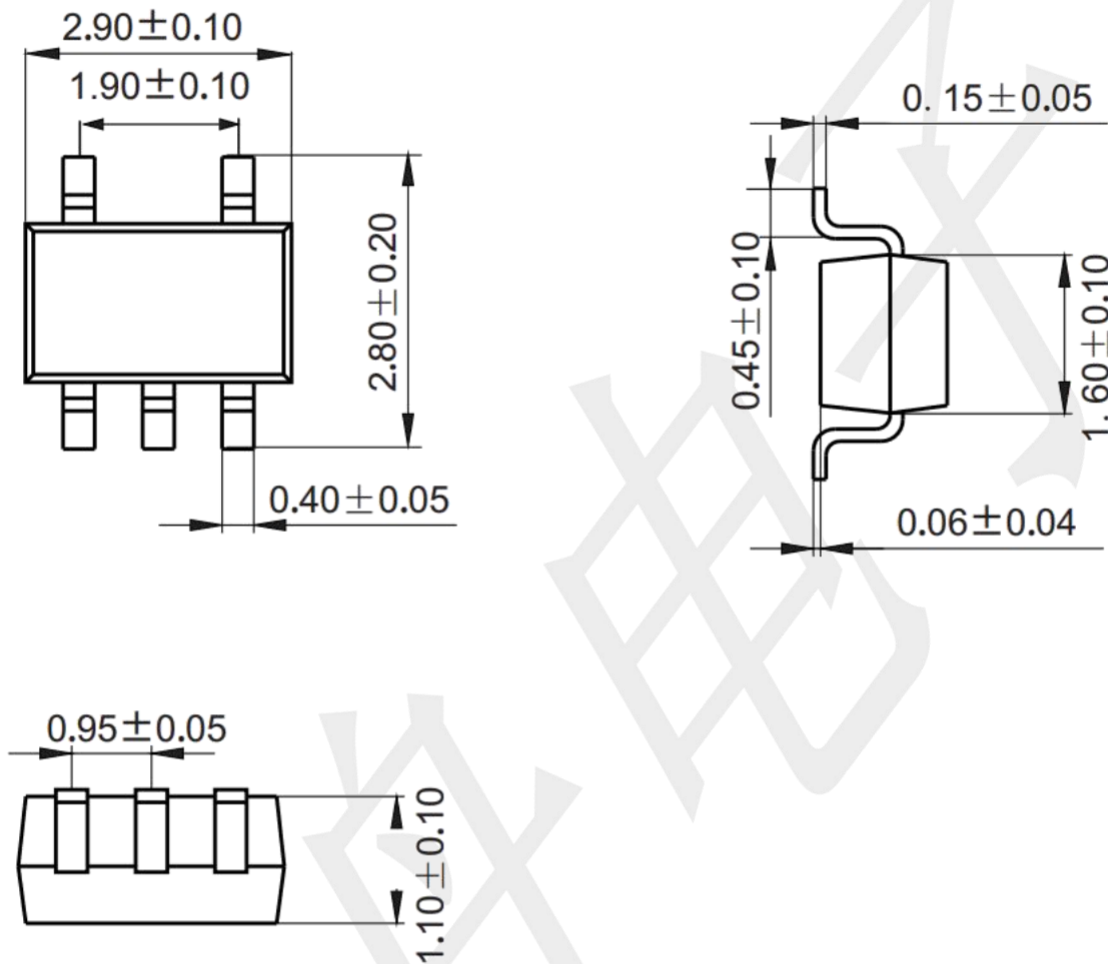

**Mounting Pad Layout (unit: mm)**

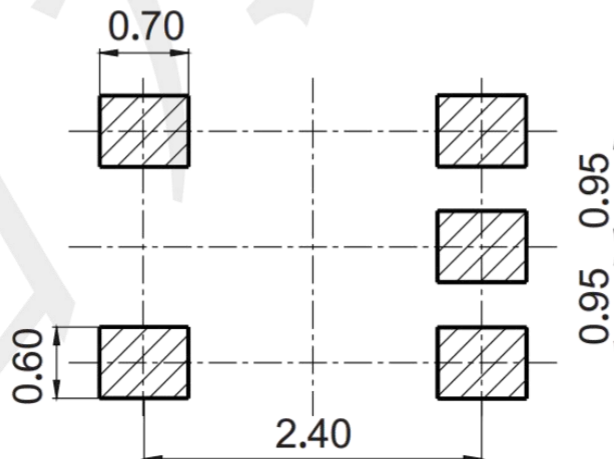

**Package Outline Dimensions (unit: mm)**

SOT23-3L

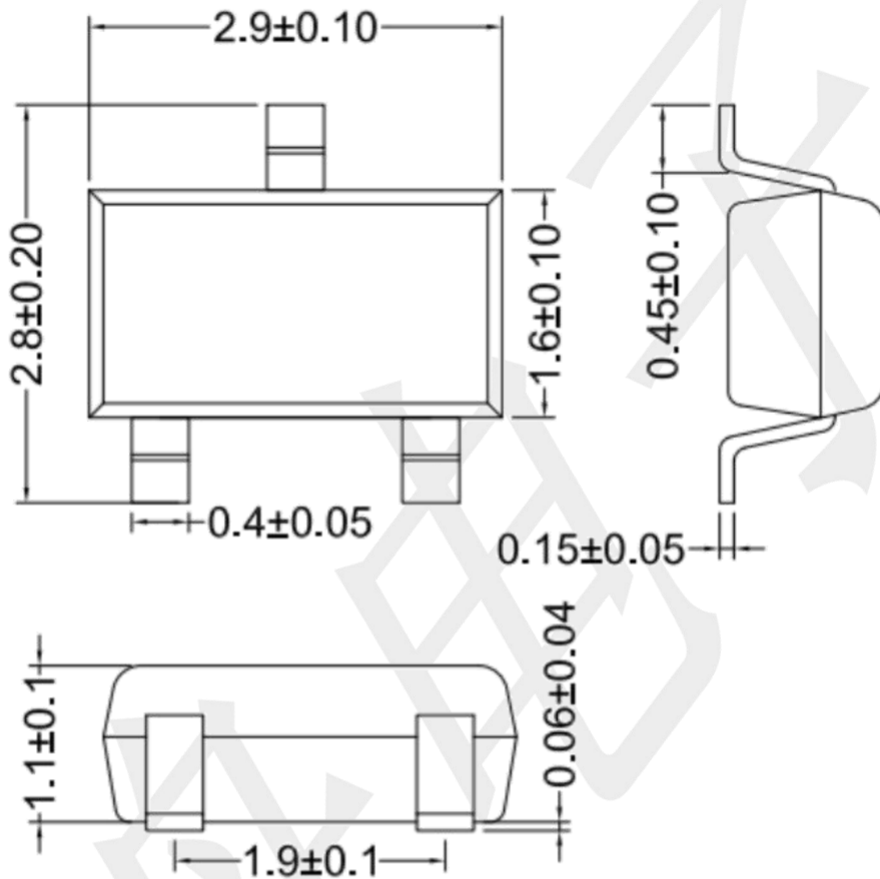

**Mounting Pad Layout (unit: mm)**

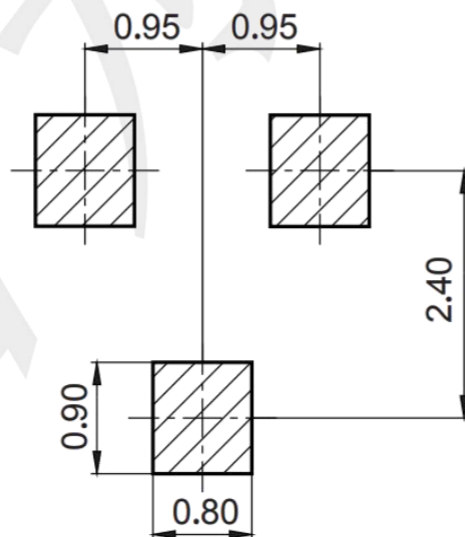

**Package Outline Dimensions (unit: mm)**

SOT23

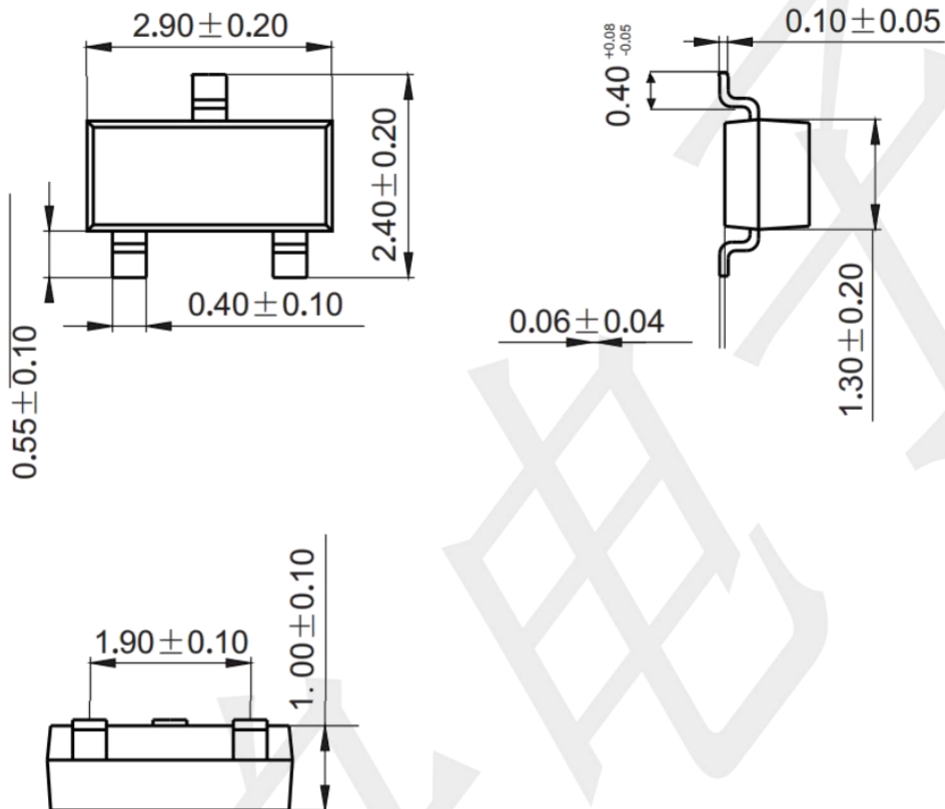

**Mounting Pad Layout (unit: mm)**

