

Product Summary

- V_{DS} 40V
- I_D 225A
- $R_{DS(ON)}$ (at $V_{GS}=10V$) $<1.4m\Omega$
- $R_{DS(ON)}$ (at $V_{GS}=4.5V$) $<2.6m\Omega$
- 100% EAS Tested
- 100% ∇V_{DS} Tested

General Description

- Split gate trench MOSFET technology
- Excellent package for heat dissipation
- High density cell design for low $R_{DS(ON)}$
- Moisture Sensitivity Level 1
- Epoxy Meets UL 94 V-0 Flammability Rating
- Halogen Free

Applications

- Power switching application
- Uninterruptible power supply
- DC-DC convertor

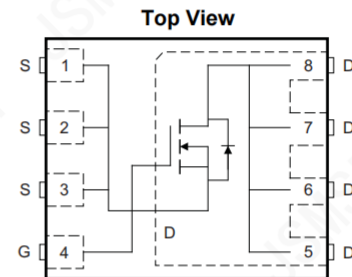
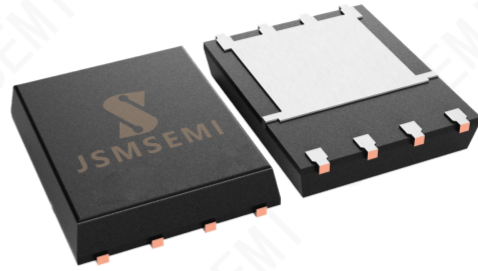

■ Absolute Maximum Ratings ($T_A=25^\circ C$ unless otherwise noted)

Parameter		Symbol	Limit	Unit
Drain-source Voltage		V_{DS}	40	V
Gate-source Voltage		V_{GS}	± 20	V
Drain Current	$T_A=25^\circ C$	I_D	60	A
	$T_A=100^\circ C$		25	
	$T_C=25^\circ C$		225	
	$T_C=100^\circ C$		141	
Pulsed Drain Current ^A		I_{DM}	720	A
Avalanche energy ^B		EAS	450	mJ
Total Power Dissipation ^C	$T_A=25^\circ C$	P_D	2.2	W
	$T_A=100^\circ C$		0.9	
	$T_C=25^\circ C$		114	
Junction and Storage Temperature Range		T_J, T_{STG}	-55~+150	$^\circ C$

■ Thermal resistance

Parameter		Symbol	Typ	Max	Units
Thermal Resistance Junction-to-Ambient ^D	Steady-State	$R_{\theta JA}$	45	55	$^\circ C/W$
	Thermal Resistance Junction-to-Case	$R_{\theta JC}$	1.0	1.1	

■ Electrical Characteristics ($T_J=25^\circ\text{C}$ unless otherwise noted)

Parameter	Symbol	Conditions	Min	Typ	Max	Units
Static Parameter						
Drain-Source Breakdown Voltage	BV_{DSS}	$V_{GS}=0\text{V}, I_D=250\mu\text{A}$	40	-	-	V
		$V_{GS}=0\text{V}, I_D=1\text{mA}$	40	-	-	V
Zero Gate Voltage Drain Current	I_{DSS}	$V_{DS}=40\text{V}, V_{GS}=0\text{V}$	-	-	1	μA
		$V_{DS}=40\text{V}, V_{GS}=0\text{V}, T_J=150^\circ\text{C}$	-	-	100	
Gate-Body Leakage Current	I_{GSS}	$V_{GS}=\pm 20\text{V}, V_{DS}=0\text{V}$	-	-	± 100	nA
Gate Threshold Voltage	$V_{GS(th)}$	$V_{DS}=V_{GS}, I_D=250\mu\text{A}$	1.3	1.7	2.3	V
Static Drain-Source On-Resistance	$R_{DS(on)}$	$V_{GS}=10\text{V}, I_D=50\text{A}$	-	1.1	1.4	m Ω
		$V_{GS}=4.5\text{V}, I_D=25\text{A}$	-	1.7	2.6	
Diode Forward Voltage	V_{SD}	$I_S=50\text{A}, V_{GS}=0\text{V}$	-	-	1.2	V
Gate resistance	R_G	$f=1\text{MHz}$	-	3.5	-	Ω
Maximum Body-Diode Continuous Current	I_S		-	-	180	A
Dynamic Parameters						
Input Capacitance	C_{iss}	$V_{DS}=20\text{V}, V_{GS}=0\text{V}, f=1\text{MHz}$	-	5500	-	pF
Output Capacitance	C_{oss}		-	1850	-	
Reverse Transfer Capacitance	C_{rss}		-	65	-	
Switching Parameters						
Total Gate Charge	Q_g	$V_{GS}=10\text{V}, V_{DS}=20\text{V}, I_D=50\text{A}$	-	87	-	nC
Gate-Source Charge	Q_{gs}		-	18	-	
Gate-Drain Charge	Q_{gd}		-	15	-	
Reverse Recovery Charge	Q_{rr}	$I_F=50\text{A}, di/dt=100\text{A}/\mu\text{s}$	-	53	-	nC
Reverse Recovery Time	t_{rr}		-	55	-	ns
Turn-on Delay Time	$t_{D(on)}$	$V_{GS}=10\text{V}, V_{DD}=20\text{V}, I_D=50\text{A}$ $R_{GEN}=3\Omega$	-	14	-	ns
Turn-on Rise Time	t_r		-	15	-	
Turn-off Delay Time	$t_{D(off)}$		-	84	-	
Turn-off fall Time	t_f		-	44	-	

A. Repetitive rating; pulse width limited by max. junction temperature.

 B. $T_J=25^\circ\text{C}, V_G=10\text{V}, R_G=25\Omega, L=0.5\text{mH}$

 C. P_d is based on max. junction temperature, using junction-case and junction-ambient thermal resistance.

■ Typical Electrical and Thermal Characteristics Diagrams

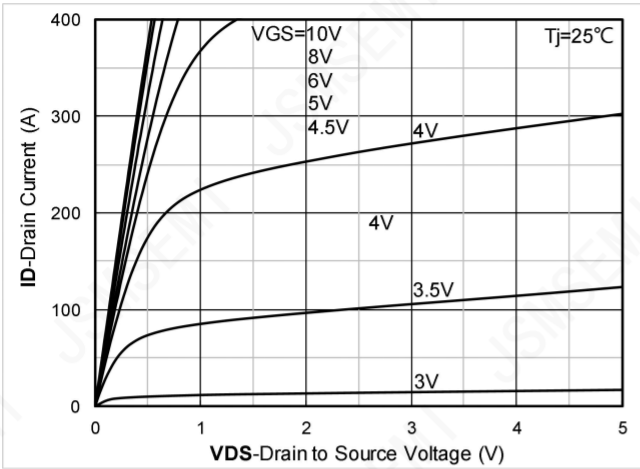

Figure 1. Output Characteristics

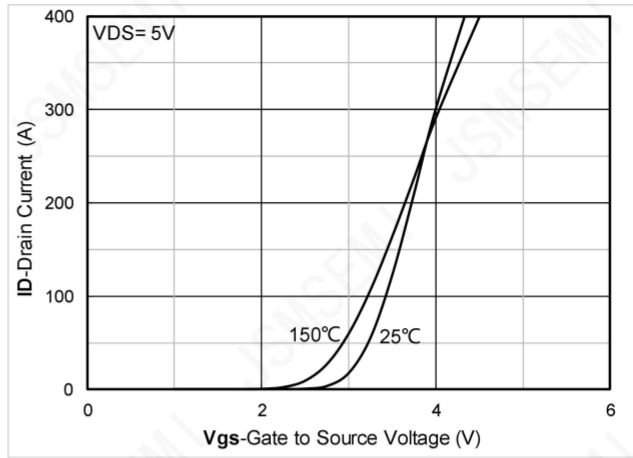

Figure 2. Transfer Characteristics

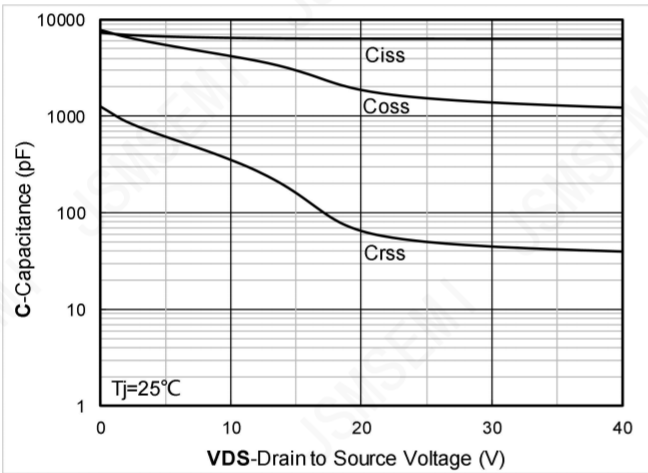

Figure 3. Capacitance Characteristics

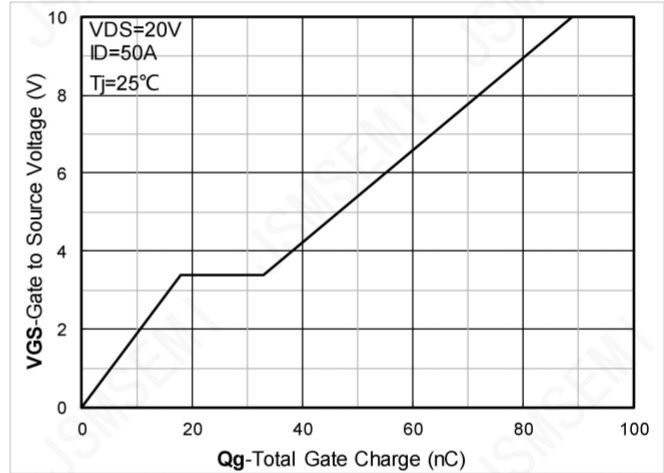

Figure 4. Gate Charge

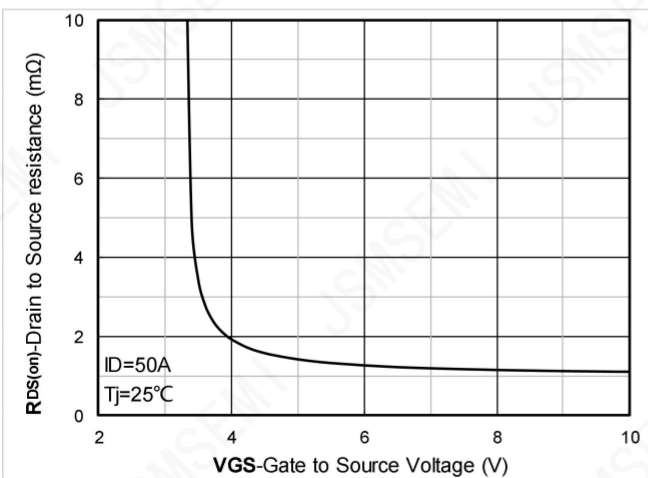

Figure 5. On-Resistance vs Gate to Source Voltage

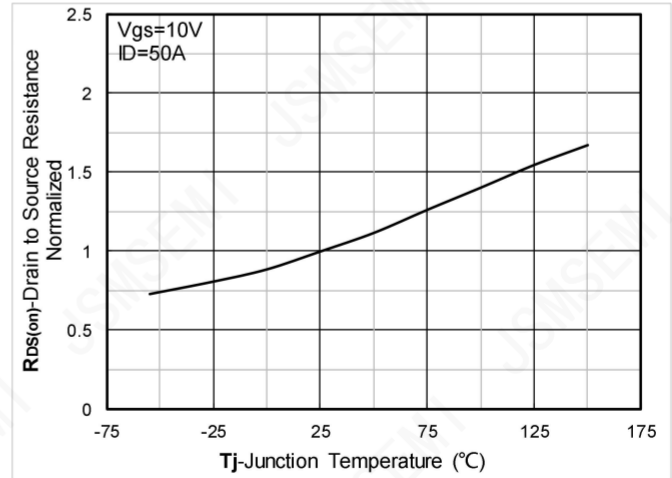

Figure 6. Normalized On-Resistance

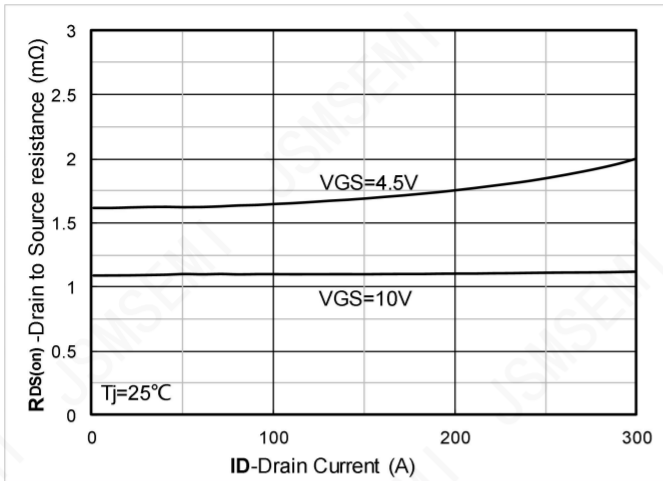

Figure 7. RDS(on) VS Drain Current

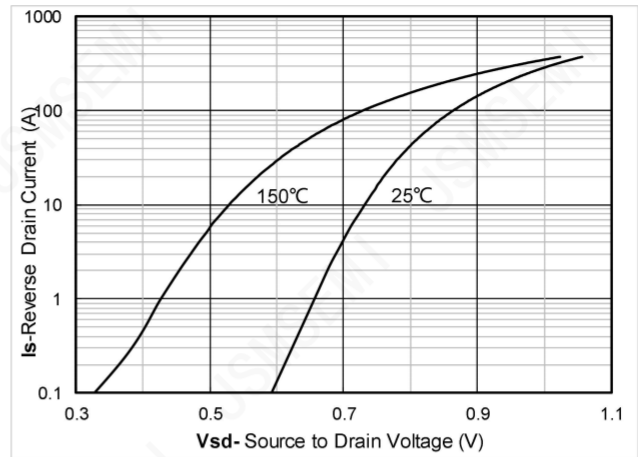

Figure 8. Forward characteristics of reverse diode

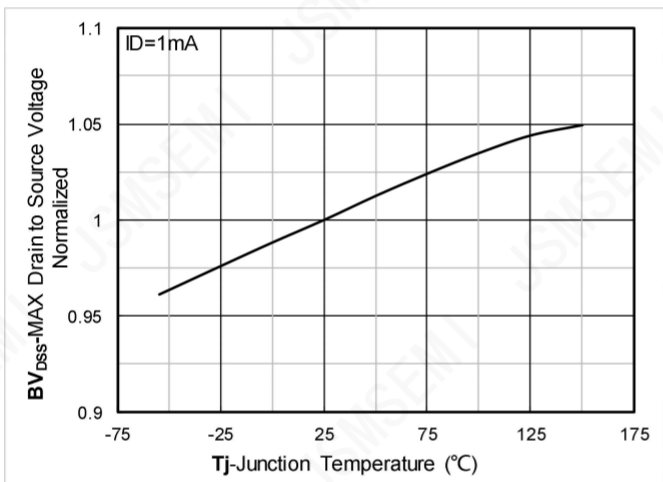

Figure 9. Normalized breakdown voltage

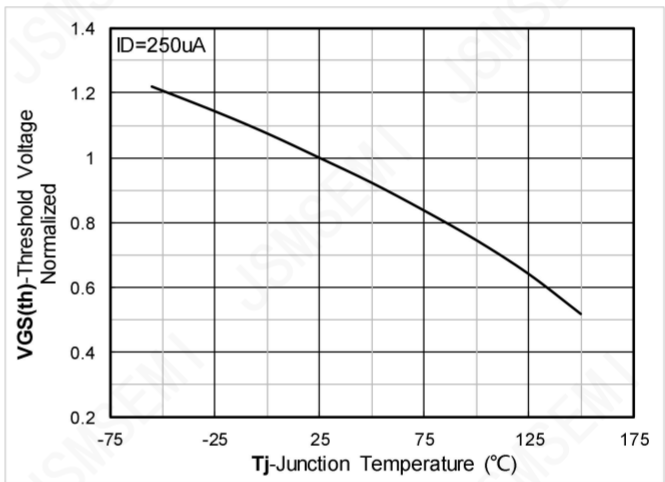

Figure 10. Normalized Threshold voltage

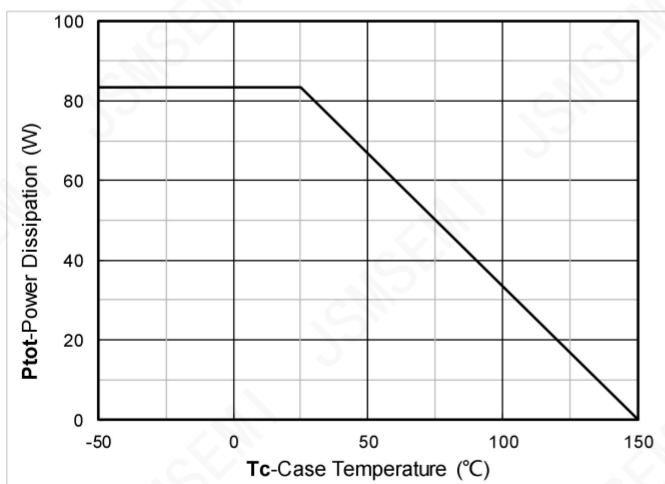

Figure 11. Power dissipation

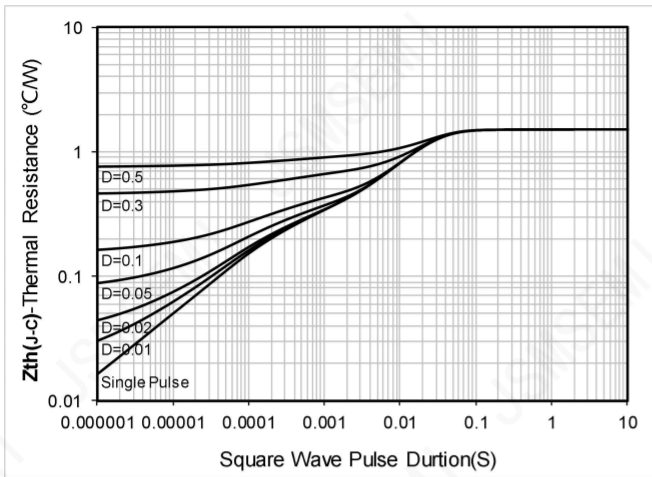

Figure 12. Maximum Transient Thermal Impedance

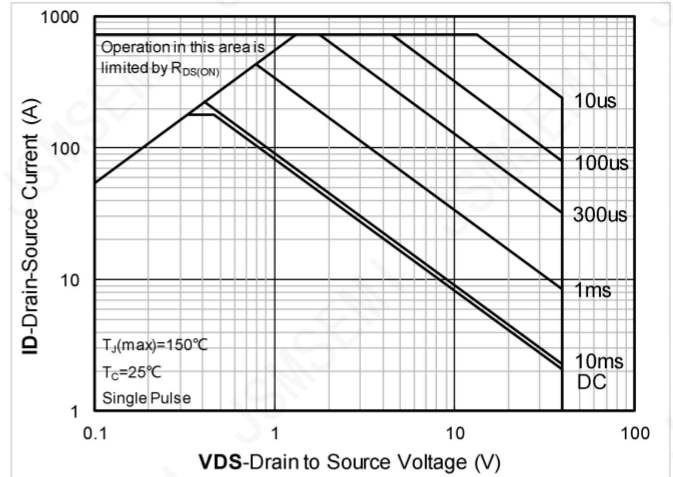

Figure 13. Safe Operation Area

Ordering Information

Order number	Package	Marking	Operation Temperature Range	MSL Grade	Ship,Quantity	Green
SBSC014N04LSIATMA1	DFN5060-8L	014N04QG5	-55 to 150°C	1	T&R,5000	RoHS

Package Information

PDFN5060-8L

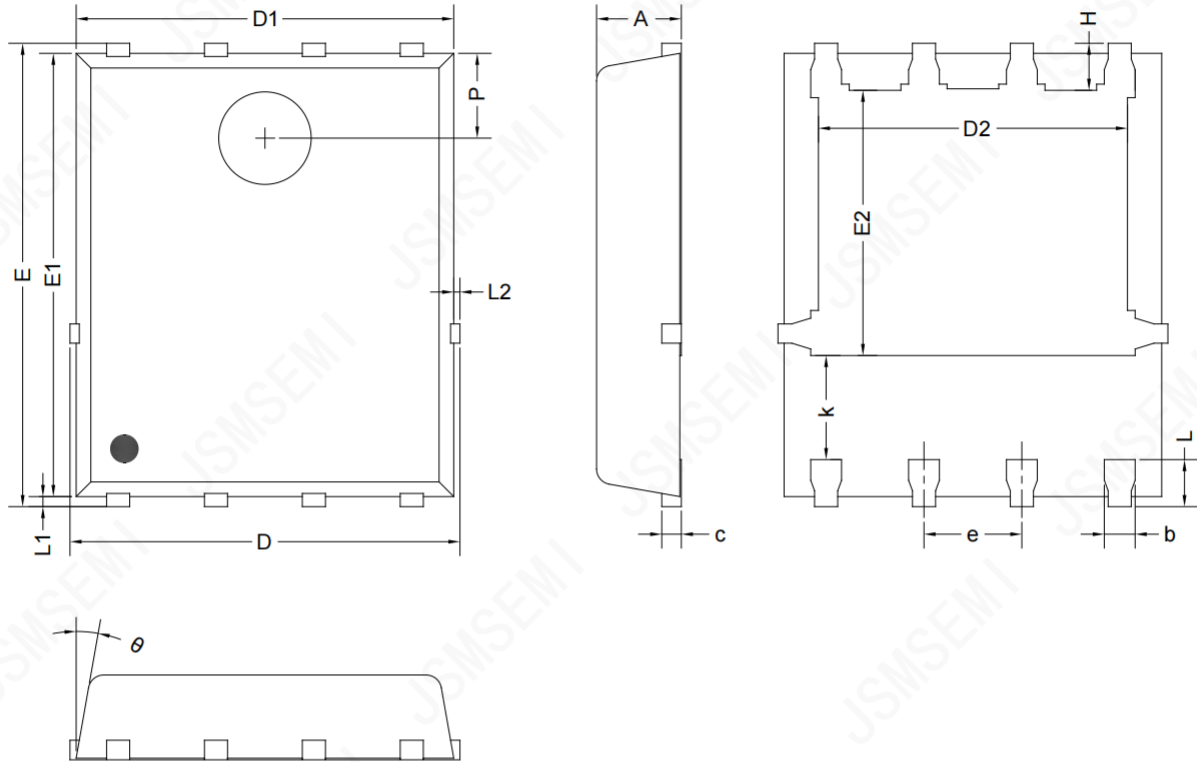

Symbol	Dimensions In Millimeters		
	MIN	NOM	MAX
A	1.000	1.100	1.200
b	0.350	0.400	0.450
c	0.210	0.250	0.340
D	4.800	-	5.100
D1	4.800	4.900	5.000
D2	3.910	4.010	4.110
E	5.900	6.000	6.100
E1	5.700	5.750	5.800
E2	3.340	3.440	3.540
e	1.270 BSC		
H	0.510	0.610	0.710
k	1.100	-	-
L	0.510	0.610	0.710
L1	0.060	0.130	0.200
L2	-	-	0.100
P	1.000	1.100	1.200
θ	8°	10°	12°

NOTE: This drawing is subject to change without notice.