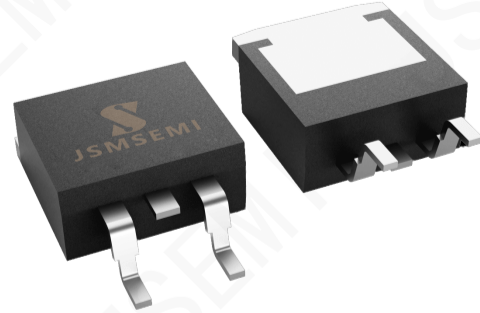

Features

- Zero Forward/Reverse Recovery Current
- High Blocking Voltage
- High Frequency Operation
- Positive Temperature Coefficient on V_F
- Temperature Independent Switching Behavior
- High surge current capability

D²PAK

Benefits

- Higher System Efficiency
- Parallel Device Convenience without thermal runaway
- Higher Temperature Application
- No Switching loss
- Hard Switching & Higher Reliability
- Environmental Protection

Applications

- Motor Drives
- Solar
- AC/DC converters
- DC/DC converters
- Uninterruptable power supplies



Maximum Ratings ($T_C=25^\circ\text{C}$ unless otherwise specified)

Parameter	Symbol	Test conditions	Value	Unit
Peak Repetitive Reverse Voltage	V_{RRM}		650	V
Peak Reverse Surge Voltage	V_{RSM}		650	V
DC Blocking Voltage	V_R		650	V
Continuous Forward Current	I_F	$T_C=25^\circ\text{C}$	32	A
		$T_C=135^\circ\text{C}$	14	
		$T_C=150^\circ\text{C}$	10	
Non repetitive Forward Surge Current	I_{FSM}	$T_C = 25^\circ\text{C}$, $t_p=10$ ms, Half Sine Pulse	65	A
		$T_C = 110^\circ\text{C}$, $t_p=10$ ms, Half Sine Pulse	55	
		$T_C = 25^\circ\text{C}$, $t_p=10$ μs , Square	520	
Repetitive peak Forward Surge Current	I_{FRM}	$T_C = 25^\circ\text{C}$, $t_p=10$ ms, Freq = 0.1Hz, 100 cycles, Half Sine Pulse	55	A
		$T_C = 110^\circ\text{C}$, $t_p=10$ ms, Freq = 0.1Hz, 100 cycles, Half Sine Pulse	45	
Total power dissipation	P_D	$T_C=25^\circ\text{C}$	94	W
Operating Junction Temperature	T_J		-55 to 175	$^\circ\text{C}$
Storage Temperature	T_{STG}		-55 to 175	$^\circ\text{C}$

Electrical Characteristics

Parameter	Symbol	Test conditions	Min	Typ	Max	Unit
DC Blocking Voltage	V_{DC}	$I_R = 250\mu A, T_J = 25^\circ C$	650			V
Forward Voltage	V_F	$I_F = 10A, T_J = 25^\circ C$		1.45	1.8	V
		$I_F = 10A, T_J = 125^\circ C$		1.6		
		$I_F = 10A, T_J = 175^\circ C$		1.7		V
Reverse Current	I_R	$V_R = 650V, T_J = 25^\circ C$		12	80	μA
		$V_R = 650V, T_J = 125^\circ C$		68		μA
		$V_R = 650V, T_J = 175^\circ C$		190		μA
Total Capacitive Charge	Q_C	$V_R = 400V, I_F = 10A,$ $di/dt = 200A/\mu s, T_J = 25^\circ C$		23		nC
Total Capacitance	C	$V_R = 1V, T_J = 25^\circ C,$ Freq = 1MHz		380		pF
		$V_R = 200V, T_J = 25^\circ C,$ Freq = 1MHz		48		
		$V_R = 400V, T_J = 25^\circ C,$ Freq = 1MHz		31		

Note: This is a majority carrier diode, so there is no reverse recovery charge

Thermal Characteristics

Parameter	Symbol	Condition	Min	Typ	Max	Unit
Thermal Resistance	$R_{th(j-c)}$	junction-case		1.6		$^\circ C/W$

Ordering Information

Order number	Package	Marking	Operation Temperature Range	MSL Grade	Ship,Quantity	Green
SNXPSC08650BJ	TO-263	SC6D10065G	-55 to 175 $^\circ C$	1	T&R,1000	RoHS

Typical Electrical Curves

Figure 1. Forward Characteristics

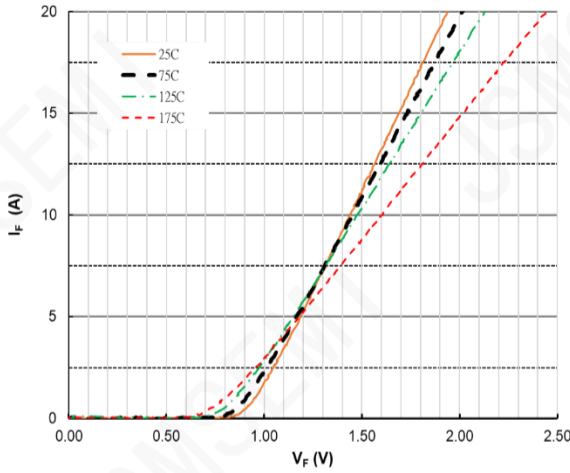

Figure 2. Forward Characteristics

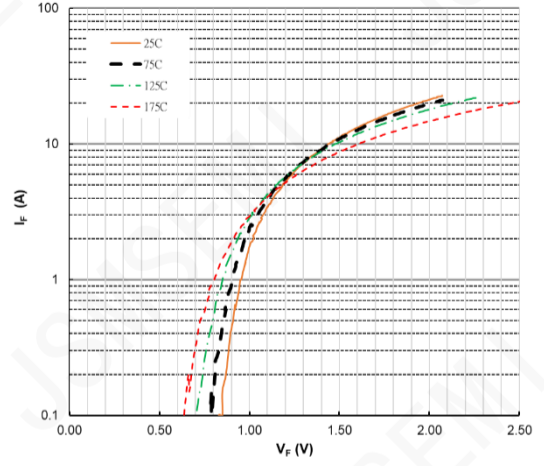

Figure 3. Reverse Characteristics

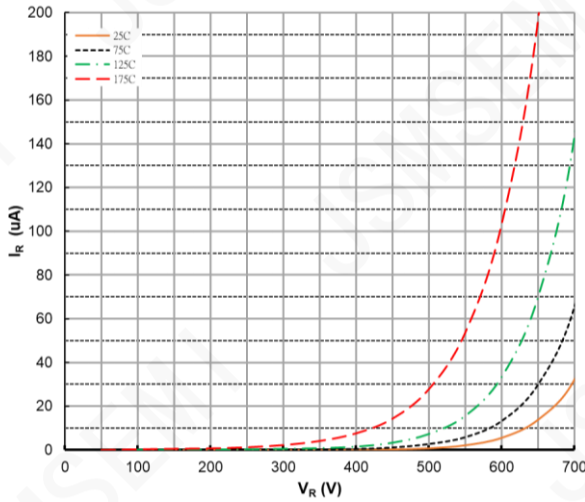

Figure 4. Power Derating

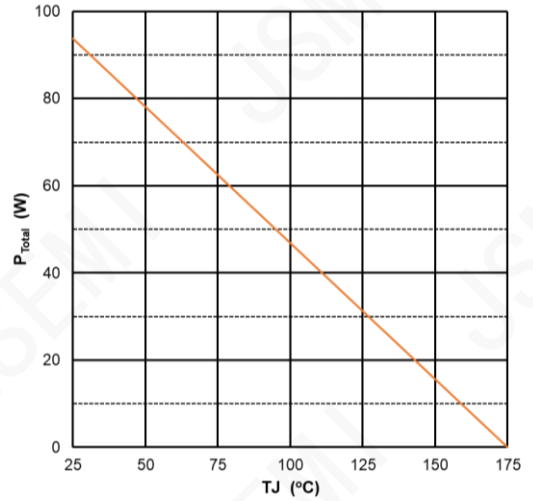

Figure 5. Capacitance vs Reverse Voltage

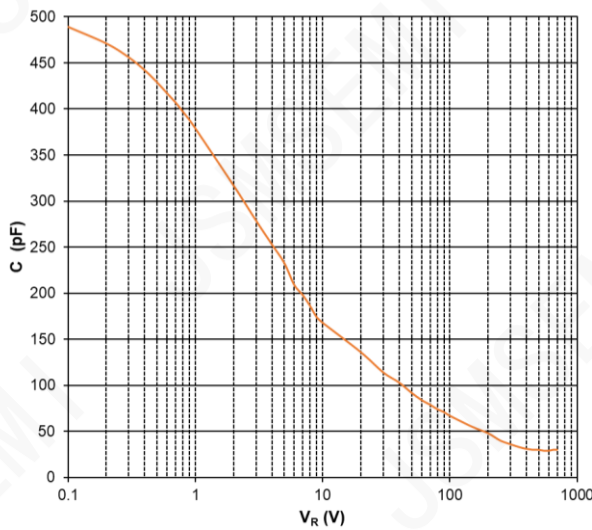
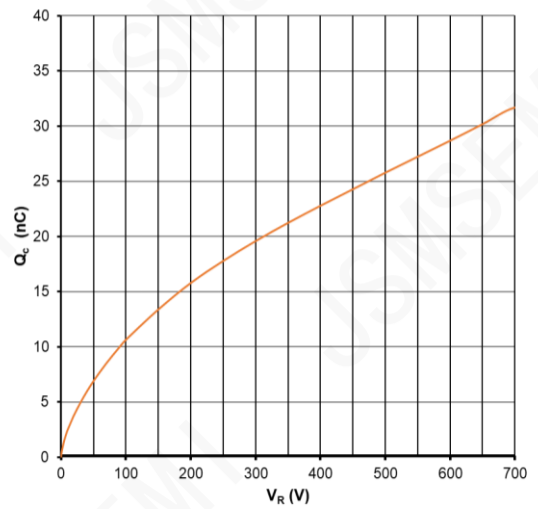
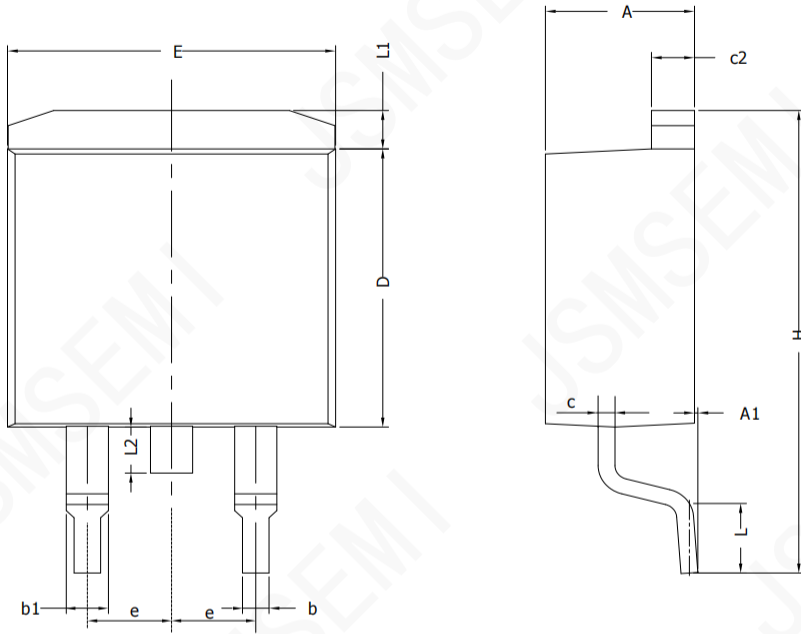

Figure 6. Recovery Charge vs Reverse Voltage



Package Outline: TO-263



SYMBOL	MIN	NOM	MAX
A	4.30	4.57	4.72
A1	0	0.10	0.25
b	0.71	0.81	0.91
c	0.30	---	0.60
c2	1.17	1.27	1.37
D	8.50	---	9.35
E	9.80	---	10.45
e	2.54BSC		
H	14.70	---	15.75
L	2.00	2.30	2.74
L1	1.12	1.27	1.42
L2	---	---	1.75

Revision History

Rev.	Change	Date
V1.0	Initial version	2/23/2022

Important Notice

JSMSEMI Semiconductor (JSMSEMI) PRODUCTS ARE NEITHER DESIGNED NOR INTENDED FOR USE IN MILITARY AND/OR AEROSPACE, AUTOMOTIVE OR MEDICAL DEVICES OR SYSTEMS UNLESS THE SPECIFIC JSMSEMI PRODUCTS ARE SPECIFICALLY DESIGNATED BY JSMSEMI FOR SUCH USE. BUYERS ACKNOWLEDGE AND AGREE THAT ANY SUCH USE OF JSMSEMI PRODUCTS WHICH JSMSEMI HAS NOT DESIGNATED FOR USE IN MILITARY AND/OR AEROSPACE, AUTOMOTIVE OR MEDICAL DEVICES OR SYSTEMS IS SOLELY AT THE BUYER' S RISK.

JSMSEMI assumes no liability for application assistance or customer product design. Customers are responsible for their products and applications using JSMSEMI products.

Resale of JSMSEMI products or services with statements diferent from or beyond the parameters stated by JSMSEMI for that product or service voids all express and any implied warranties for the associated JSMSEMI product or s ervice. JSMSEMI is not responsible or liable for any such statements.

JSMSEMI All Rights Reserved. Information and data in this document are owned by JSMSEMI wholly and may not be edited, reproduced, or redistributed in any way without the express written consent from JSMSEMI.

Any and all information described or contained herein are subject to change without notice due to product/technology improvement, etc. When designing equipment, refer to the "Delivery Specification" for the JSMSEMI product that you intend to use.

For additional information please contact Kevin@jsmsemi.com or visit www.jsmsemi.com