

Product Summary

- V_{DS} -60 V
- I_{DS} -110 A
- $R_{DS(ON)}$ (at $V_{GS} = -10V$) $< 6.5m\Omega$ (Typ)

Application

- Reverse Battery protection
- Load switch
- Power management
- PWM Application

Package and Pin Configuration

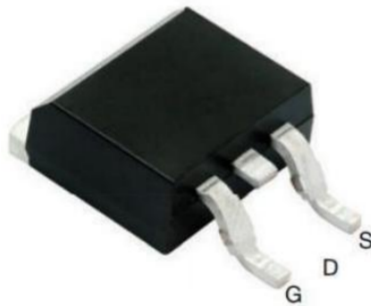

TO-263

Circuit diagram

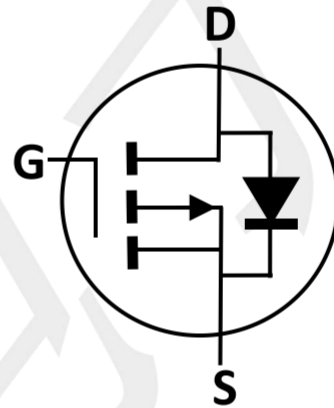

Equivalent Circuit

Absolute Maximum Ratings ($T_A = 25^\circ C$ unless otherwise noted)

PARAMETER	SYMBOL	LIMIT	UNIT
Drain-Source Voltage	V_{DS}	-60	V
Gate-Source Voltage	V_{GS}	± 20	V
Continuous Drain Current	I_D	-110	A
Pulsed Drain Current <small>(note1)</small>	I_{DM}	-200	A
Maximum Power Dissipation $T_C = 25^\circ C$	P_D	120	W
Operating Junction Temperature Range	T_J	-55 to +150	$^\circ C$
Storage Temperature Range	T_{stg}	-55 to +150	$^\circ C$

Thermal Characteristic

PARAMETER		Symbol	Value	Unit
Thermal Resistance from Junction to Case ($t \leq 10s$)	PCB Mount <small>(note2)</small>	$R_{\theta JC}$	1.04	$^\circ C/W$

notes 1. Repetitive Rating: Pulse width limited by maximum junction temperature.

2. When mounted on 1" square PCB (FR4 material).

Electrical Characteristics (T_A=25°C unless otherwise noted)

PARAMETER	CONDITIONS	SYMBOL	MIN	TYP	MAX	UNIT
Static						
Drain-Source Breakdown Voltage	V _{GS} =0V, I _D =-250μA	BV _{DSS}	-60	--	--	V
Gate-Source Threshold Voltage	V _{DS} =V _{GS} , I _D = -250μA	V _{GS(th)}	-1.2	-2.0	-2.5	V
Gate-Source Leakage	V _{DS} =0V, V _{GS} = ±20V	I _{GSS}	--	--	±100	nA
Zero Gate Voltage Drain Current	V _{DS} = -60V, V _{GS} =0V	I _{DSS}	--	-0.1	-1	μA
	V _{DS} = -60V, T _J =125°C		--	-10	-50	μA
Drain-Source On-State Resistance (Note 1)	V _{GS} = -10V, I _D = -20A	R _{DS(on)}	--	6.5	8.0	mΩ
	V _{GS} = -4.5V, I _D = -10A		--	8.5	12	
Forward Transconductance (Note 2)	V _{DS} = -10V, I _D = -3A	g _{fs}	--	18	--	S
Dynamic (Note 2)						
Total Gate Charge (Note 3)	V _{DS} = -30V, I _D = -5A, V _{GS} = -10V	Q _g	--	81	--	nC
Gate-Source Charge (Note 3)		Q _{gs}	--	17	--	
Gate-Drain Charge (Note 3)		Q _{gd}	--	13	--	
Input Capacitance	V _{DS} = -25V, V _{GS} = 0V, F = 1.0MHz	C _{iss}	--	5560	--	pF
Output Capacitance		C _{oss}	--	934	--	
Reverse Transfer Capacitance		C _{rss}	--	50	--	
Switching						
Turn-On Delay Time (Note 3)	V _{DD} = -48V, I _D = -1A, V _{GS} = -10V, R _{GEN} = 6Ω	t _{d(on)}	--	25	--	nS
Rise Time (Note 3)		t _r	--	45	--	
Turn-Off Delay Time (Note 3)		t _{d(off)}	--	72	--	
Fall Time (Note 3)		t _f	--	61	--	
Source-Drain Diode Ratings and Characteristics (Note 2)						
Forward Voltage	V _{GS} = 0V, I _{SD} = -1A	V _{SD}	--	-0.76	-1.1	V
Continuous Source Current	Integral reverse diode in the MOSFET	I _S	--	--	-75	A
Pulsed Current (Note 1)		I _{SM}	--	--	-150	A

Notes:

1. Pulse test; pulse width ≤ 300 μS, duty cycle ≤ 2%.
2. Guaranteed by design, not subject to production testing.
3. Independent of operating temperature

TYPICAL CHARACTERISTICS (25 °C, unless otherwise noted)

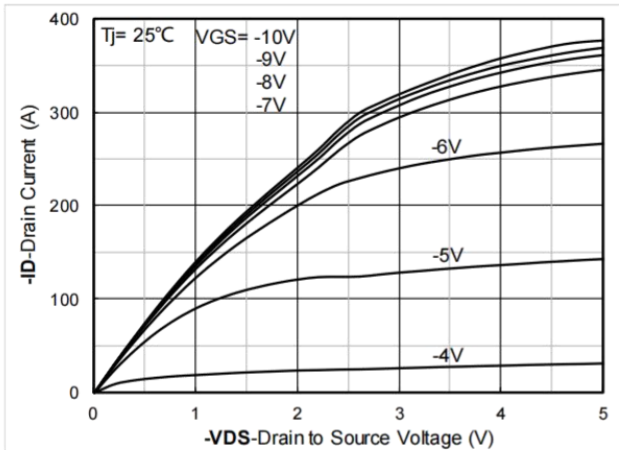

Figure 1. Output Characteristics

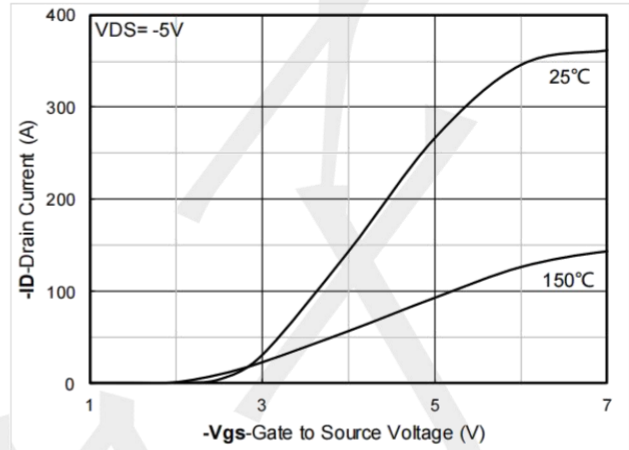

Figure 2. Transfer Characteristics

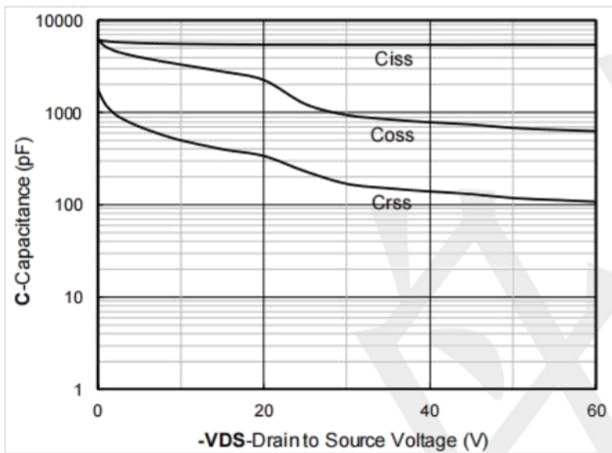

Figure 3. Capacitance Characteristics

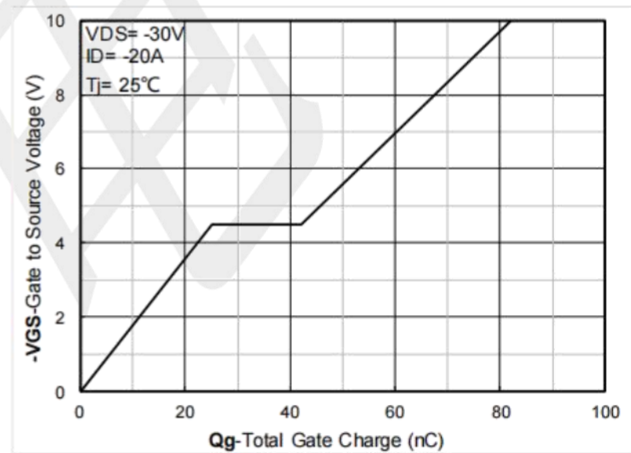

Figure 4. Gate Charge

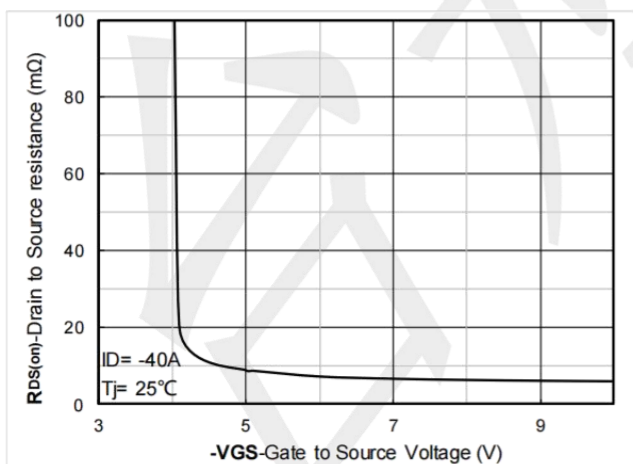

Figure 5. On-Resistance vs Gate to Source Voltage

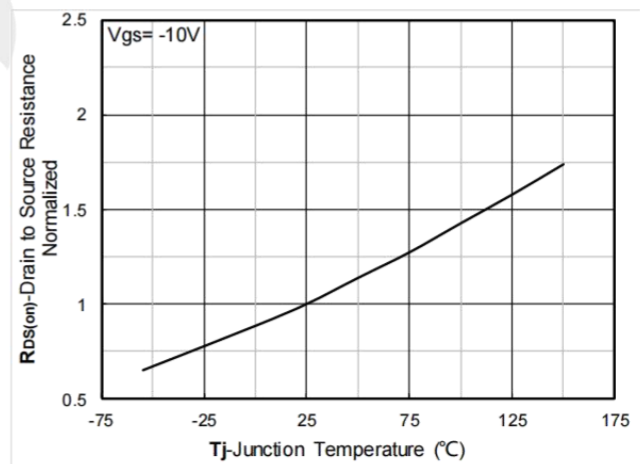
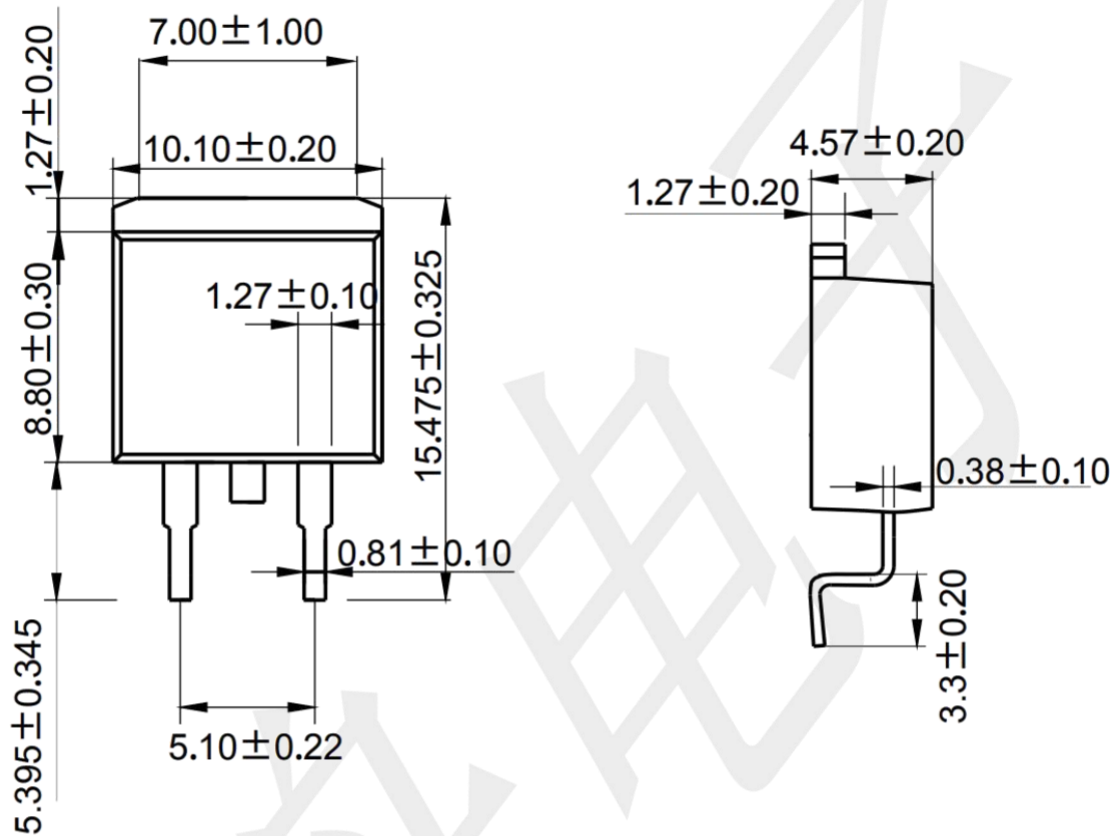

Figure 6. Normalized On-Resistance

Package Outline Dimensions (unit: mm)

TO-263



Mounting Pad Layout (unit: mm)

