

Features

- 700V,13A
 $R_{DS(ON)} < 360m\Omega @ V_{GS}=10V$ TYP:330m Ω
- Super Junction technology
- Much lower Ron*A performance for On-state efficiency
- Much lower FOM for fast switching efficiency

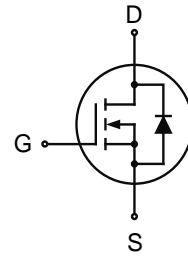

Schematic Diagram

Applications

- Power faction correction (PFC)
- Switched mode power supplies (SMPS)
- Uninterruptible power supply (UPS)
- LED lighting powe

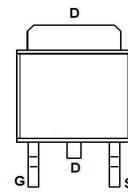

TO-252

Package Marking and Ordering Information

Device Marking	Device	Device Package	Reel Size	Tape width	Quantity (PCS)
C70R360KM	APC70R360KM	TO-252	-	-	2500

ABSOLUTE MAXIMUM RATINGS ($T_J=25^{\circ}C$ unless otherwise noted)

Parameter	Symbol	Value	Unit
Drain-Source Voltage	V_{DS}	700	V
Gate-Source Voltage	V_{GS}	± 30	V
Continuous Drain Current ($T_c = 25^{\circ}C$)	I_D	13	A
Continuous Drain Current ($T_c = 100^{\circ}C$)	I_D	8	A
Pulsed Drain Current ⁽¹⁾	I_{DM}	52	A
Single Pulsed Avalanche Energy ⁽²⁾	E_{AS}	93	mJ
Drain Power Dissipation	P_D	128	W
Thermal Resistance from Junction to Case	$R_{\theta JC}$	0.98	$^{\circ}C/W$
Thermal Resistance- Junction to Ambient	$R_{\theta JA}$	100	$^{\circ}C/W$
Junction Temperature	T_J	150	$^{\circ}C$
Storage Temperature	T_{STG}	-55~ +150	$^{\circ}C$

MOSFET ELECTRICAL CHARACTERISTICS(T_J=25°C unless otherwise noted)

Parameter	Symbol	Test Condition	Min	Type	Max	Unit
Static Characteristics						
Drain-source breakdown voltage	V _{(BR)DSS}	V _{GS} = 0V, I _D =250μA	700	-	-	V
Zero gate voltage drain current	I _{DSS}	V _{DS} =700V, V _{GS} = 0V	-	-	1	uA
		V _{DS} =700V, V _{GS} = 0V T _J =150°C			10	uA
Gate-body leakage current	I _{GSS}	V _{GS} = ±30V, V _{DS} = 0V	-	-	±100	nA
Gate threshold voltage	V _{GS(th)}	V _{DS} =V _{GS} , I _D =250μA	3.0	3.5	4.0	V
Drain-source on-resistance	R _{DS(on)}	V _{GS} =10V, I _D =3A	-	330	360	mΩ
Dynamic characteristics						
Input Capacitance	C _{iss}	V _{DS} =100V, V _{GS} =0V, f =1.0MHz	-	742	-	pF
Output Capacitance	C _{oss}		-	35.1	-	
Reverse Transfer Capacitance	C _{rss}		-	0.5	-	
Gate Resistance	R _g	f =1.0MHz		9.3		Ω
Switching characteristics						
Turn-on delay time	t _{d(on)}	V _{DD} =400V, I _D =6A, R _G =27Ω, V _G =10V	-	19.9	-	ns
Turn-on rise time	t _r		-	25.8	-	
Turn-off delay time	t _{d(off)}		-	105	-	
Turn-off fall time	t _f		-	31.8	-	
Total Gate Charge	Q _g	V _{DS} =480V, I _D =6A, V _{GS} =10V	-	25.9	-	nC
Gate-Source Charge	Q _{gs}		-	3.7	-	
Gate-Drain Charge	Q _{gd}		-	13.8	-	
Source-Drain Diode characteristics						
Diode Forward voltage	V _{SD}	T _c =25°C, V _{GS} =0V, I _S =6A	-	0.83	1.0	V
Diode Forward current	I _S	T _c =25°C	-	-	13	A
Body Diode Reverse Recovery Time	t _{rr}	T _c =25°C, I _F =6A, di/dt=100A/us		210		ns
Body Diode Reverse Recovery Charge	Q _{rr}	T _c =25°C, I _F =6A, di/dt=100A/us		2.05		uc

Notes:

1. Pluse width limited by maximum junction temperature
2. L=30mH, IAS=2.5A, VDD=150V, VG=10V, RG=50Ω, starting T_J=25°C
3. Pulse Test: Pulse width ≤300μs, Duty cycle≤2%
4. Essentially independent of operating temperature

Test Circuit

Gate Charge Test Circuit & Waveform

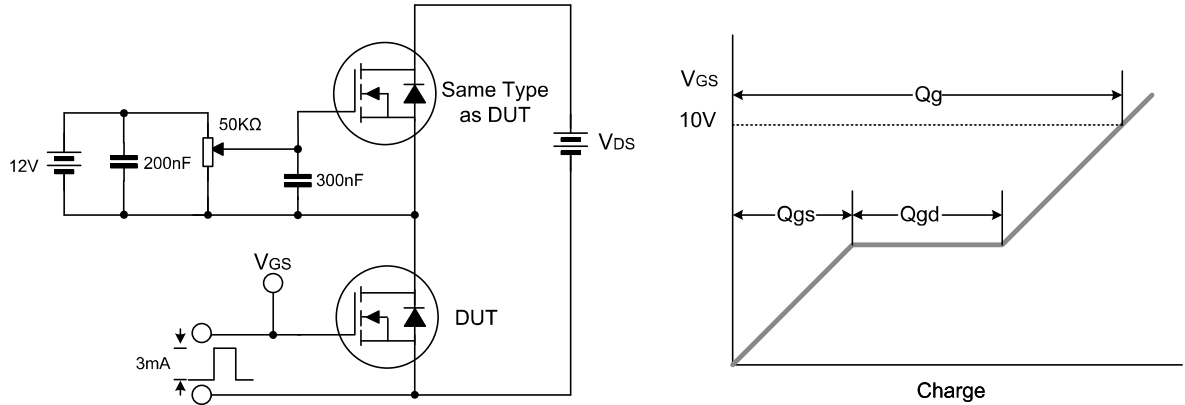

Resistive Switching Test Circuit & Waveform

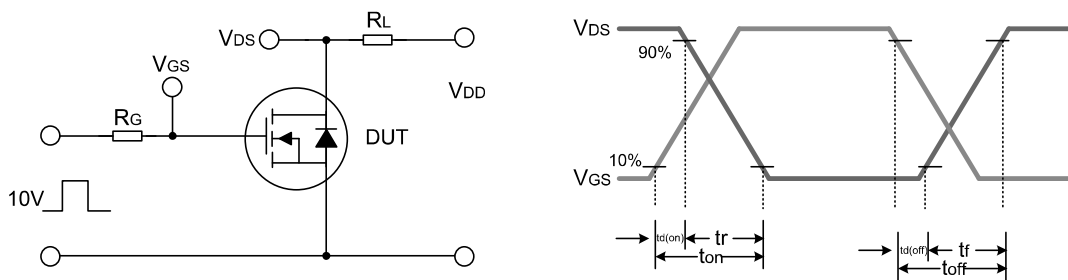

Unclamped Inductive Switching Test Circuit & Waveform

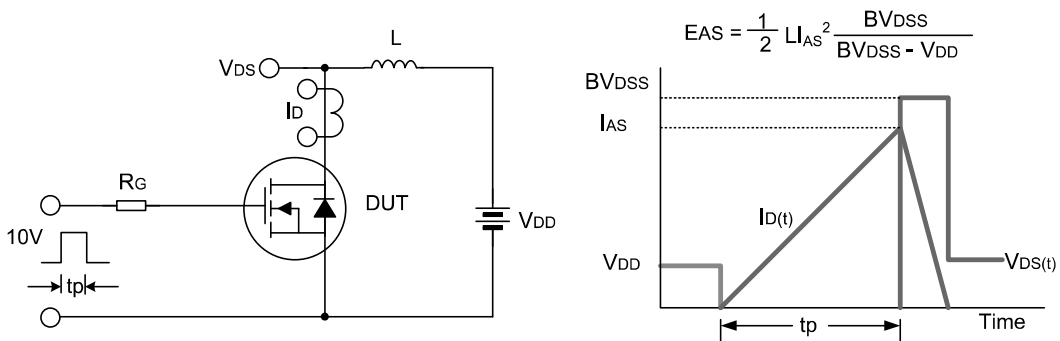

Typical Performance Characteristics

Fig 1. Output Characteristics (Tj=25°C)

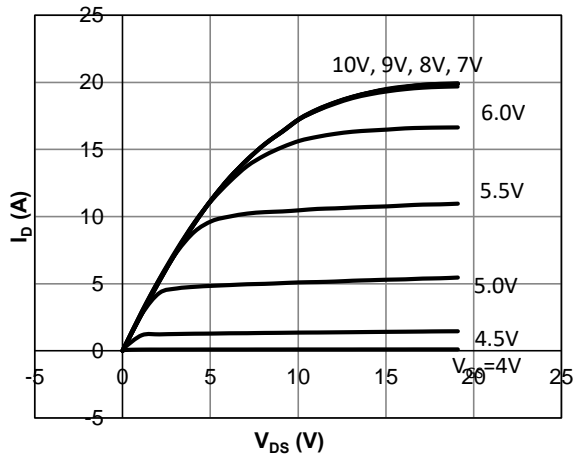

Fig 2. Output Characteristics (Tj=150°C)

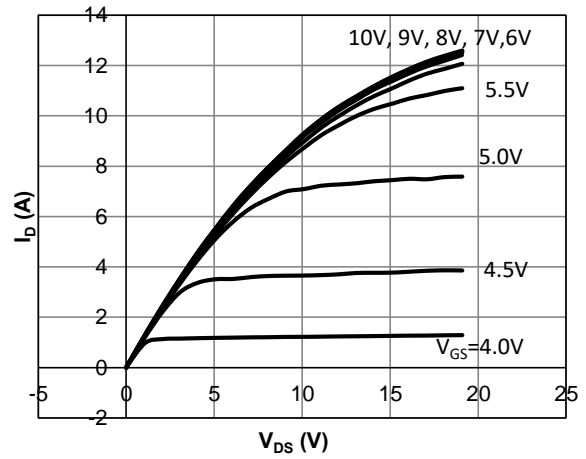

Fig 3: Transfer Characteristics

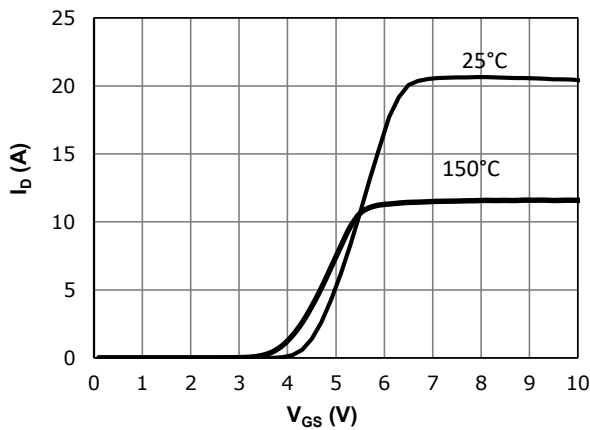

Fig 4: V_{TH} Vs T_j Temperature Characteristics

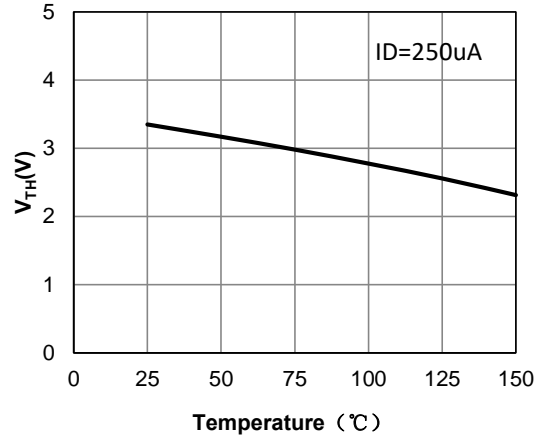

Fig 5: $R_{DS(on)}$ Vs I_{DS} Characteristics (Tc=25°C)

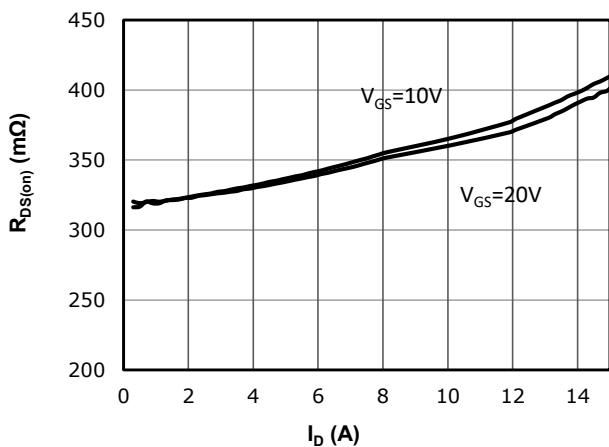
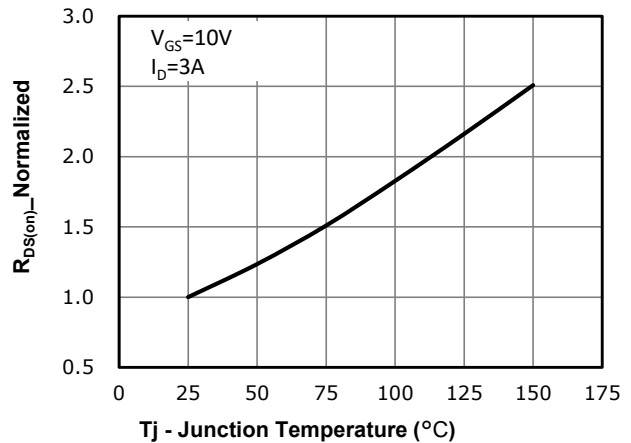

Fig 6: $R_{DS(on)}$ vs. Temperature



Typical Performance Characteristics

Fig 7: BVdss vs. Temperature

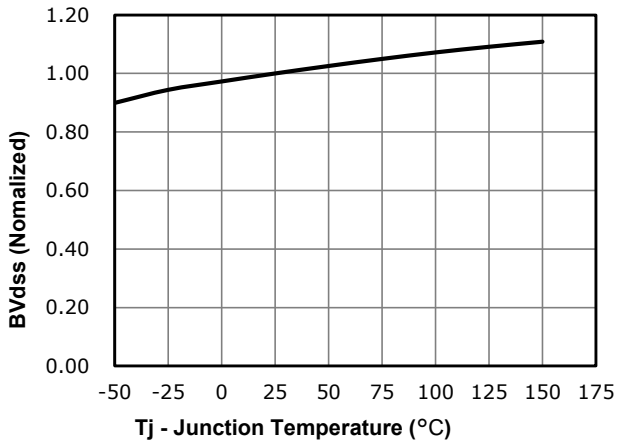

Fig 8: Rds(on) vs Gate Voltage

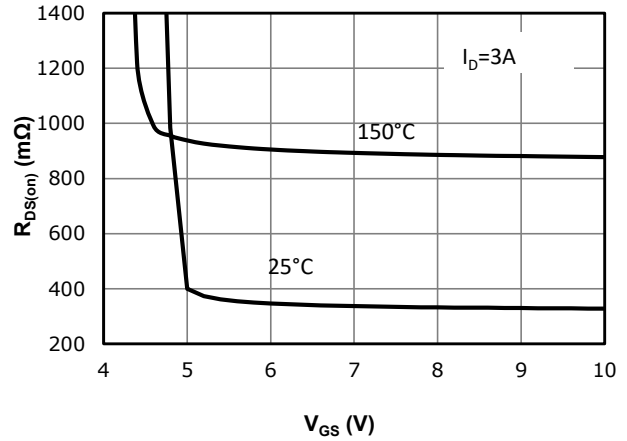

Fig 9: Body-diode Forward Characteristics

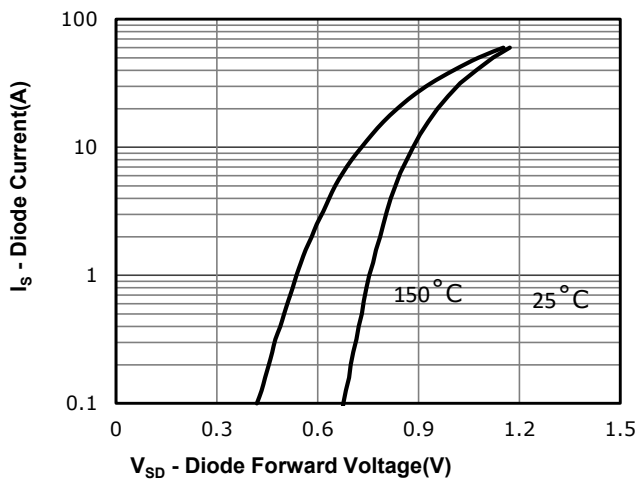

Fig 10: Gate Charge Characteristics

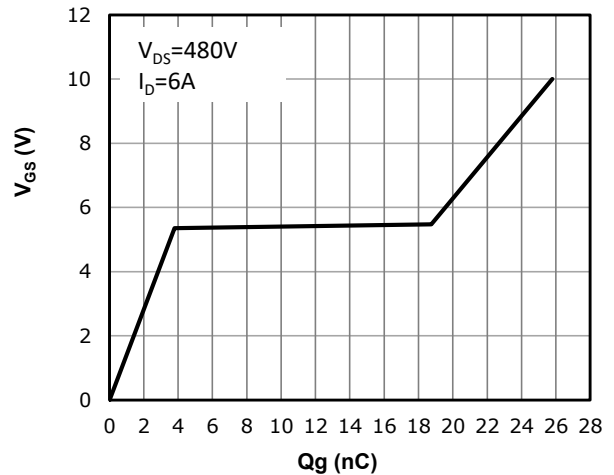

Fig 11: Capacitance Characteristics

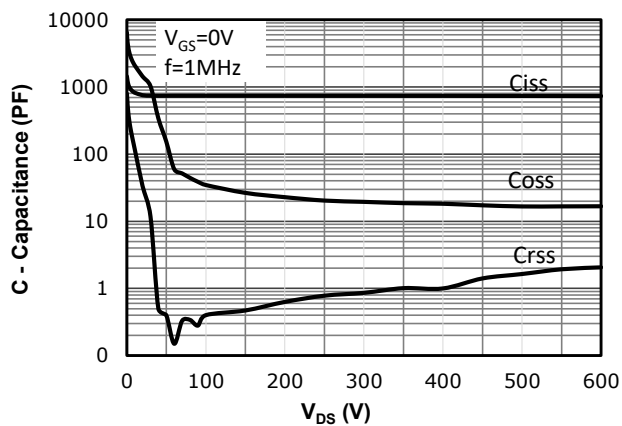
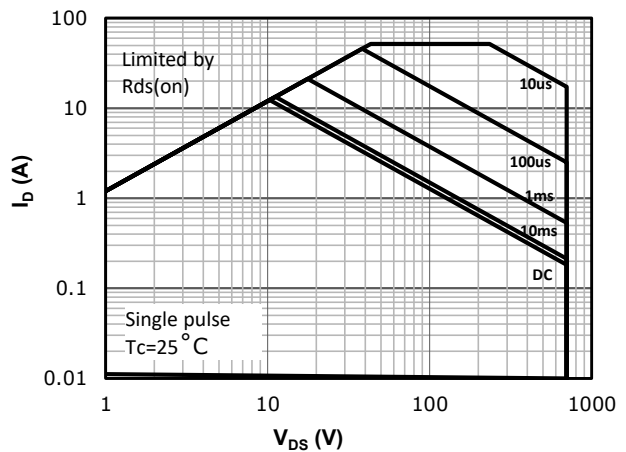
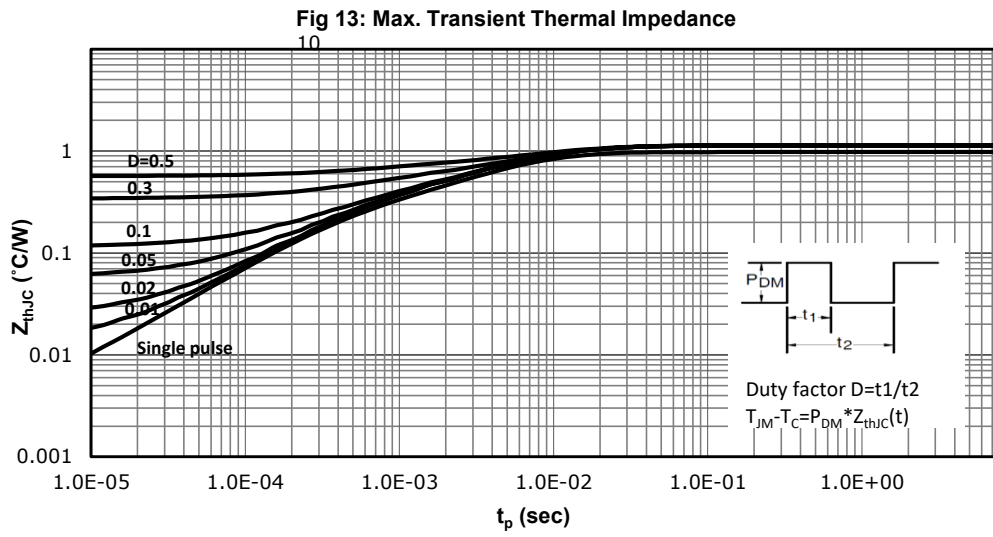

Fig 12: Safe Operating Area



Typical Performance Characteristics



Package Dimensions
TO-252

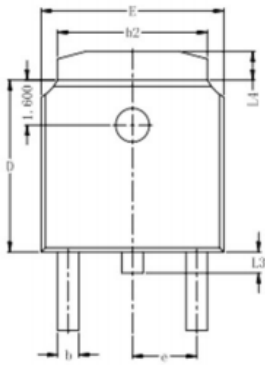

TOP VIEW

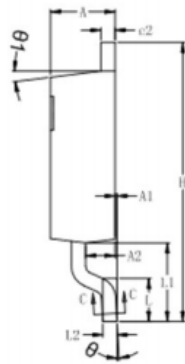

SIDE VIEW (Right)

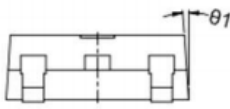

SIDE VIEW (Front)

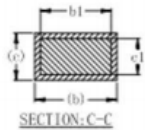

SECTION-C-C

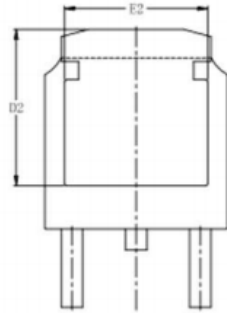

OPTION 1
 BOTTOM VIEW

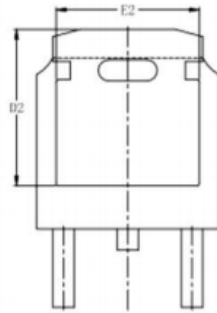

OPTION 2
 BOTTOM VIEW

DIM SYMBOL	MIN.	NOM.	MAX.
A	2.200	2.300	2.400
A1	0.000	0.070	0.130
A2	0.950	1.050	1.150
b	0.700	0.800	0.900
b1	0.660	0.760	0.860
b2	5.134	5.334	5.534
c	0.448	0.548	0.648
c1	0.458	0.508	0.558
c2	0.448	0.548	0.648
D	6.000	6.100	6.200
D2	5.372	5.572	5.772
E	6.400	6.500	6.600
E2	4.900	5.100	5.300
e	2.286 BSC.		
H	9.700	9.900	10.100
L	1.380	1.525	1.725
L1	2.588	2.788	2.988
L2	0.508 BSC.		
L3	0.600	0.750	0.950
L4	0.812	1.012	1.212
θ	1°	3°	5°
θ1	6°	7°	8°

Revision History

Revision	Release	Remark
V1.0	2024/05/11	Initial Release

Disclaimer

The information given in this document describes the independent performance of the product, but similar performance is not guaranteed under other working conditions, and cannot be guaranteed when installed with other products or equipment. To achieve the required performance of the product in actual scenarios, the customer should conduct a complete application test to assess the functionality of the product.

Allpower assumes no responsibility for equipment failures result from using products at values that exceed the ratings, operating conditions, or other parameters listed in the product specifications.

The product described in this specification is not applicable for aerospace or other applications which requires high reliability. Customers using or selling these products for use in medical, life-saving, or life-sustaining applications do so at their own risk and agree to fully indemnify.

Due to product or technical improvements, the information described or contained herein may be changed without prior notice.