



MICROCHIP

MCP19125
Flyback Battery Charger
Evaluation Board
User's Guide

Note the following details of the code protection feature on Microchip devices:

- Microchip products meet the specification contained in their particular Microchip Data Sheet.
- Microchip believes that its family of products is one of the most secure families of its kind on the market today, when used in the intended manner and under normal conditions.
- There are dishonest and possibly illegal methods used to breach the code protection feature. All of these methods, to our knowledge, require using the Microchip products in a manner outside the operating specifications contained in Microchip's Data Sheets. Most likely, the person doing so is engaged in theft of intellectual property.
- Microchip is willing to work with the customer who is concerned about the integrity of their code.
- Neither Microchip nor any other semiconductor manufacturer can guarantee the security of their code. Code protection does not mean that we are guaranteeing the product as "unbreakable."

Code protection is constantly evolving. We at Microchip are committed to continuously improving the code protection features of our products. Attempts to break Microchip's code protection feature may be a violation of the Digital Millennium Copyright Act. If such acts allow unauthorized access to your software or other copyrighted work, you may have a right to sue for relief under that Act.

Information contained in this publication regarding device applications and the like is provided only for your convenience and may be superseded by updates. It is your responsibility to ensure that your application meets with your specifications. MICROCHIP MAKES NO REPRESENTATIONS OR WARRANTIES OF ANY KIND WHETHER EXPRESS OR IMPLIED, WRITTEN OR ORAL, STATUTORY OR OTHERWISE, RELATED TO THE INFORMATION, INCLUDING BUT NOT LIMITED TO ITS CONDITION, QUALITY, PERFORMANCE, MERCHANTABILITY OR FITNESS FOR PURPOSE. Microchip disclaims all liability arising from this information and its use. Use of Microchip devices in life support and/or safety applications is entirely at the buyer's risk, and the buyer agrees to defend, indemnify and hold harmless Microchip from any and all damages, claims, suits, or expenses resulting from such use. No licenses are conveyed, implicitly or otherwise, under any Microchip intellectual property rights unless otherwise stated.

Microchip received ISO/TS-16949:2009 certification for its worldwide headquarters, design and wafer fabrication facilities in Chandler and Tempe, Arizona; Gresham, Oregon and design centers in California and India. The Company's quality system processes and procedures are for its PIC[®] MCUs and dsPIC[®] DSCs, KEELOQ[®] code hopping devices, Serial EEPROMs, microperipherals, nonvolatile memory and analog products. In addition, Microchip's quality system for the design and manufacture of development systems is ISO 9001:2000 certified.

**QUALITY MANAGEMENT SYSTEM
CERTIFIED BY DNV
= ISO/TS 16949 =**

Trademarks

The Microchip name and logo, the Microchip logo, AnyRate, AVR, AVR logo, AVR Freaks, BeaconThings, BitCloud, CryptoMemory, CryptoRF, dsPIC, FlashFlex, flexPWR, Helder, JukeBlox, KEELOQ, KEELOQ logo, Klear, LANCheck, LINK MD, maXStylus, maXTouch, MediaLB, megaAVR, MOST, MOST logo, MPLAB, OptoLyzer, PIC, picoPower, PICSTART, PIC32 logo, Prochip Designer, QTouch, RightTouch, SAM-BA, SpyNIC, SST, SST Logo, SuperFlash, tinyAVR, UNI/O, and XMEGA are registered trademarks of Microchip Technology Incorporated in the U.S.A. and other countries.

ClockWorks, The Embedded Control Solutions Company, EtherSynch, Hyper Speed Control, HyperLight Load, IntelliMOS, mTouch, Precision Edge, and Quiet-Wire are registered trademarks of Microchip Technology Incorporated in the U.S.A.

Adjacent Key Suppression, AKS, Analog-for-the-Digital Age, Any Capacitor, AnyIn, AnyOut, BodyCom, chipKIT, chipKIT logo, CodeGuard, CryptoAuthentication, CryptoCompanion, CryptoController, dsPICDEM, dsPICDEM.net, Dynamic Average Matching, DAM, ECAN, EtherGREEN, In-Circuit Serial Programming, ICSP, Inter-Chip Connectivity, JitterBlocker, KlearNet, KlearNet logo, Mindi, MiWi, motorBench, MPASM, MPF, MPLAB Certified logo, MPLIB, MPLINK, MultiTRAK, NetDetach, Omniscient Code Generation, PICDEM, PICDEM.net, PICkit, PICtail, PureSilicon, QMatrix, RightTouch logo, REAL ICE, Ripple Blocker, SAM-ICE, Serial Quad I/O, SMART-I.S., SQI, SuperSwitcher, SuperSwitcher II, Total Endurance, TSHARC, USBCheck, VariSense, ViewSpan, WiperLock, Wireless DNA, and ZENA are trademarks of Microchip Technology Incorporated in the U.S.A. and other countries.

SQTP is a service mark of Microchip Technology Incorporated in the U.S.A.

Silicon Storage Technology is a registered trademark of Microchip Technology Inc. in other countries.

GestIC is a registered trademark of Microchip Technology Germany II GmbH & Co. KG, a subsidiary of Microchip Technology Inc., in other countries.

All other trademarks mentioned herein are property of their respective companies.

© 2017, Microchip Technology Incorporated, All Rights Reserved.
ISBN: 978-1-5224-2140-5

Object of Declaration: MCP19125 Flyback Battery Charger Evaluation Board

EU Declaration of Conformity

This declaration of conformity is issued by the manufacturer.

The development/evaluation tool is designed to be used for research and development in a laboratory environment. This development/evaluation tool is not a Finished Appliance, nor is it intended for incorporation into Finished Appliances that are made commercially available as single functional units to end users under EU EMC Directive 2004/108/EC and as supported by the European Commission's Guide for the EMC Directive 2004/108/EC (8th February 2010).

This development/evaluation tool complies with EU RoHS2 Directive 2011/65/EU.

This development/evaluation tool, when incorporating wireless and radio-telecom functionality, is in compliance with the essential requirement and other relevant provisions of the R&TTE Directive 1999/5/EC and the FCC rules as stated in the declaration of conformity provided in the module datasheet and the module product page available at www.microchip.com.

For information regarding the exclusive, limited warranties applicable to Microchip products, please see Microchip's standard terms and conditions of sale, which are printed on our sales documentation and available at www.microchip.com.

Signed for and on behalf of Microchip Technology Inc. at Chandler, Arizona, USA.

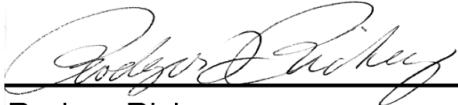

Rodger Richey
Director of Development Tools



Date

NOTES:

Table of Contents

Preface	7
Introduction.....	7
Document Layout	7
Conventions Used in This Guide.....	8
Recommended Reading.....	9
The Microchip Website.....	9
Customer Support	9
Revision History	9
 Chapter 1. Product Overview	
1.1 Introduction	10
1.2 MCP19125 Device Short Overview	10
1.3 What is the MCP19125 Flyback Battery Charger Evaluation Board?	12
1.4 What the MCP19125 Flyback Battery Charger Evaluation Board Kit Contains	12
 Chapter 2. Installation and Operation	
2.1 Board Features	14
2.2 Getting Started	15
2.2.1 Instruments and Tools	15
2.2.2 Installation	15
 Chapter 3. Graphical User Interface	
3.1 Running the MCP19125 Flyback Battery Charger Evaluation Board	16
3.1.1 Setting up the GUI and the Board	16
3.1.2 Charge Configuration	17
3.1.3 Running a Charge Profile	18
3.1.4 Battery Chemistry Charge Profiles	20
3.2 Programming the MCP19125 Flyback Battery Charger Evaluation Board	24
 Appendix A. Schematic and Layouts	
A.1 Introduction	26
A.2 Board – Schematic 1	27
A.3 Board – Schematic 2	28
A.4 Board – Top Silk Layer	29
A.5 Board – Top Copper and Silk Layer	30
A.6 Board – Top Copper	31
A.7 Board – Mid-Layer 1	32
A.8 Board – Mid-Layer 2	33

MCP19125 Flyback Battery Charger Evaluation Board User's Guide

A.9 Board – Bottom Copper	34
A.10 Board – Bottom Cooper and Silk Layer	35
A.11 Board – Bottom Silk Layer	36
Appendix B. Bill of Materials (BOM)	38
Appendix C. Charge Profile Block Diagrams	42
C.1 Introduction	42
Worldwide Sales and Service	58

Preface

NOTICE TO CUSTOMERS

All documentation becomes dated, and this manual is no exception. Microchip tools and documentation are constantly evolving to meet customer needs, so some actual dialogs and/or tool descriptions may differ from those in this document. Please refer to our website (www.microchip.com) to obtain the latest documentation available.

Documents are identified with a “DS” number. This number is located on the bottom of each page, in front of the page number. The numbering convention for the DS number is “DSXXXXXXXXA”, where “XXXXXXXX” is the document number and “A” is the revision level of the document.

For the most up-to-date information on development tools, see the MPLAB® IDE online help. Select the Help menu, and then Topics to open a list of available online help files.

INTRODUCTION

This chapter contains general information that will be useful to know before using the MCP19125 Flyback Battery Charger Evaluation Board. Items discussed in this chapter include:

- Document Layout
- Conventions Used in This Guide
- Recommended Reading
- The Microchip WebSite
- Customer Support
- Revision History

DOCUMENT LAYOUT

This document describes how to use the MCP19125 Flyback Battery Charger Evaluation Board. The document is organized as follows:

- **Chapter 1. “Product Overview”** – Important information about the MCP19125 Flyback Battery Charger Evaluation Board.
- **Chapter 2. “Installation and Operation”** – Includes instructions on how to get started with MCP19125 Flyback Battery Charger Evaluation Board.
- **Chapter 3. “Graphical User Interface”** – Provides instructions on how to set up and use the Graphical User Interface (GUI).
- **Appendix A. “Schematic and Layouts”** – Shows the schematic and layout diagrams for the MCP19125 Flyback Battery Charger Evaluation Board.
- **Appendix B. “Bill of Materials (BOM)”** – Lists the parts used to build the MCP19125 Flyback Battery Charger Evaluation Board.
- **Appendix C. “Charge Profile Block Diagrams”** – Includes block diagrams showing the flow of logic that enable the MCP19125 to control the charge cycle for efficient battery charging.

MCP19125 Flyback Battery Charger Evaluation Board User's Guide

CONVENTIONS USED IN THIS GUIDE

This manual uses the following documentation conventions:

DOCUMENTATION CONVENTIONS

Description	Represents	Examples
Arial font:		
Italic characters	Referenced books	<i>MPLAB[®] IDE User's Guide</i>
	Emphasized text	...is the <i>only</i> compiler...
Initial caps	A window	the Output window
	A dialog	the Settings dialog
	A menu selection	select Enable Programmer
Quotes	A field name in a window or dialog	"Save project before build"
Underlined, Italic text with right angle bracket	A menu path	<u><i>File>Save</i></u>
Bold characters	A dialog button	Click OK
	A tab	Click the Power tab
N'Rnnnn	A number in verilog format, where N is the total number of digits, R is the radix and n is a digit.	4'b0010, 2'hF1
Text in angle brackets < >	A key on the keyboard	Press <Enter>, <F1>
Courier New font:		
Plain Courier New	Sample source code	#define START
	Filenames	autoexec.bat
	File paths	c:\mcc18\h
	Keywords	_asm, _endasm, static
	Command-line options	-Opa+, -Opa-
	Bit values	0, 1
	Constants	0xFF, 'A'
Italic Courier New	A variable argument	<i>file.o</i> , where <i>file</i> can be any valid filename
Square brackets []	Optional arguments	mcc18 [options] <i>file</i> [options]
Curly brackets and pipe character: { }	Choice of mutually exclusive arguments; an OR selection	errorlevel {0 1}
Ellipses...	Replaces repeated text	var_name [, var_name...]
	Represents code supplied by user	void main (void) { ... }

RECOMMENDED READING

This user's guide describes how to use MCP19125 Flyback Battery Charger Evaluation Board. The following Microchip document is available and recommended as a supplemental reference resource:

- **MCP19125 Data Sheet – “Digitally Enhanced Power Analog Synchronous Low-Side Dual Loop PWM Controller” (DS20005619)**

THE MICROCHIP WEBSITE

Microchip provides online support via our website at www.microchip.com. This website is used as a means to make files and information easily available to customers. Accessible by using your favorite Internet browser, the website contains the following information:

- **Product Support** – Data sheets and errata, application notes and sample programs, design resources, user's guides and hardware support documents, latest software releases and archived software
- **General Technical Support** – Frequently Asked Questions (FAQs), technical support requests, online discussion groups, Microchip consultant program member listing
- **Business of Microchip** – Product selector and ordering guides, latest Microchip press releases, listing of seminars and events, listings of Microchip sales offices, distributors and factory representatives.

CUSTOMER SUPPORT

Users of Microchip products can receive assistance through several channels:

- Distributor or Representative
- Local Sales Office
- Field Application Engineer (FAE)
- Technical Support

Customers should contact their distributor, representative or field application engineer (FAE) for support. Local sales offices are also available to help customers. A listing of sales offices and locations is included in the back of this document.

Technical support is available through the website at:

<http://www.microchip.com/support>.

REVISION HISTORY

Revision A (September 2017)

- Original release of this document.

Chapter 1. Product Overview

1.1 INTRODUCTION

This provides an overview of the MCP19125 Flyback Battery Charger Evaluation Board and covers the following topics:

- MCP19125 Device Short Overview
- What is the MCP19125 Flyback Battery Charger Evaluation Board?
- What the MCP19125 Flyback Battery Charger Evaluation Board Kit Contains

1.2 MCP19125 DEVICE SHORT OVERVIEW

The MCP19125 is a highly-integrated, mixed-signal low-side synchronous Pulse Width Modulation (PWM) controller that operates from 4.5V to 42V. This device features individual analog PWM control loops for both current regulation or voltage regulation. These features, along with an integrated microcontroller core, make this an ideal device for battery charging applications, LED lighting systems, and any other low-side switch PWM applications. Complete customization of device operating parameters, start-up or shutdown profiles, protection levels, and fault handling procedures are accomplished by setting digital registers using Microchip's MPLAB® X Integrated Development Environment software and one of Microchip's many in-circuit debugger and device programmers.

The MCP19125 features integrated low-side synchronous drivers, an internal linear regulator, and 4k word nonvolatile memory, all in a space-saving 28-pin 5 mm x 5 mm QFN package.

1.3 WHAT IS THE MCP19125 FLYBACK BATTERY CHARGER EVALUATION BOARD?

The MCP19125 Flyback Battery Charger Evaluation Board demonstrates how the MCP19125 device operates in a battery charging application utilizing a synchronous flyback topology. It is configured to regulate the amount of charge current, and the type of charging, while simultaneously reading the state of the battery to change between operation modes for optimized charge profiles. The MCP19125 Flyback Battery Charger Evaluation Board was designed to operate with a wide input voltage range of 4.5 V to 42V. Nearly all operational and control system parameters are programmable by utilizing the integrated PIC[®] microcontroller.

The board comes preprogrammed with firmware designed to operate with a downloadable Graphical User Interface (GUI). MPLAB[®] X Integrated Development Environment (IDE) software can be used to download the user-defined firmware, thus tailoring it to the user's specific application. The evaluation board contains headers for In-Circuit Serial Programming (ICSP), as well as I²C communication.

The MCP19125 Flyback Battery Charger Evaluation Board firmware implements an Synchronous Serial Port (SSP) module process derived from the I²C specification to allow the MCP19125 to communicate with the GUI through a PICKit[™] Serial Analyzer. MPLAB[®] X IDE, MPLAB[®] XC8 Compiler toolchain, the MCP19XXX Multi-Chemistry Multi-Topology Battery Charger GUI and the MCP19125 Flyback Battery Charger Evaluation Board firmware are available for download from the Microchip website. See [Chapter 3. "Graphical User Interface"](#) for details.

1.4 WHAT THE MCP19125 FLYBACK BATTERY CHARGER EVALUATION BOARD KIT CONTAINS

This MCP19125 Flyback Battery Charger Evaluation Board kit includes the following:

- MCP19125 Flyback Battery Charger Evaluation Board (ADM00745)
- Important Information Sheet.

MCP19125 Flyback Battery Charger Evaluation Board User's Guide

NOTES:

Chapter 2. Installation and Operation

2.1 BOARD FEATURES

The MCP19125 Flyback Battery Charger Evaluation Board can be used to charge Lithium-Ion (Li-Ion) batteries of two-four cells, Nickel Metal-Hydride (NiMH) batteries of two-seven cells and Valve-Regulated Lead-Acid (VRLA) batteries of up to three or six cells. The board uses the MCP19125 digitally enhanced PWM controller to generate the charge algorithms for the various battery types. The board can run in Rapid Charge Current mode for NiMH batteries, as well as Constant-Current/Constant-Voltage mode for Li-Ion batteries. The MCP19125 Flyback Battery Charger Evaluation Board also has two charge configurations for VRLA batteries, which can be charged in both Step Charge and Constant-Current modes.

MCP19125 Flyback Battery Charger Evaluation Board was developed to provide an intelligent, compact, and highly efficient solution demonstrating the MCP19125 as a battery charger utilizing a synchronous flyback topology. The dual control loops of the MCP19125 device allow monitoring and regulation of the charge current and battery pack voltage. The battery charger board also provides several status and fault indications for various states of the board. Furthermore, the MCP19125 is programmed to read the temperature of the battery pack if a temperature sensing resistor is available, and react to temperature changes.

Component LD1 blinks at a rate of 50 ms on, 1.75s off when the charger is in Standby mode, and a rate of 0.75s on, 0.75s off when the charger is charging. Moreover, the board detects the presence or removal of a battery pack. The board has the capability to connect to both the PICkit™ 3 In-Circuit Debugger/Programmer for reprogramming and the PICkit™ Serial Analyzer to operate in conjunction with the GUI. Normally, the PICkit™ Serial Analyzer is used to configure the charge cycle and change parameters.

The MCP19125 Flyback Battery Charger Evaluation Board is fully assembled, programmed, and tested to evaluate and demonstrate the MCP19125 operating performance in a digitally-controlled “smart battery-charging” application for various common battery chemistries.

2.2 GETTING STARTED

The MCP19125 requires a computer with Microsoft® Windows® XP/7/8 operating system and a USB 2.0 port. To run the software, follow the steps described in this section.

2.2.1 Instruments and Tools

- Adjustable DC power supply with 0V-24V voltage range
- MCP19125 Flyback Battery Charger Evaluation Board
- MCP19XXX Multi-Chemistry Multi-Topology Battery Charger GUI
- PICKit™ Serial Analyzer
- Battery Pack

2.2.2 Installation

Follow the steps below to download and install the MCP19125 firmware and GUI:

1. Download the MCP19125 Flyback Battery Charger Evaluation Board Firmware and GUI archive from the Microchip website at <http://www.microchip.com/wwwproducts/en/MCP19125>.
2. After downloading and unzipping the archive, open the GUI folder and locate the `setup.exe` file.
3. Double-click the file. In the Application Install - Security Warning dialog box, press the **Install** button.
4. Once the installation is complete, the GUI will appear on the screen, as shown in [Figure 2-1](#):

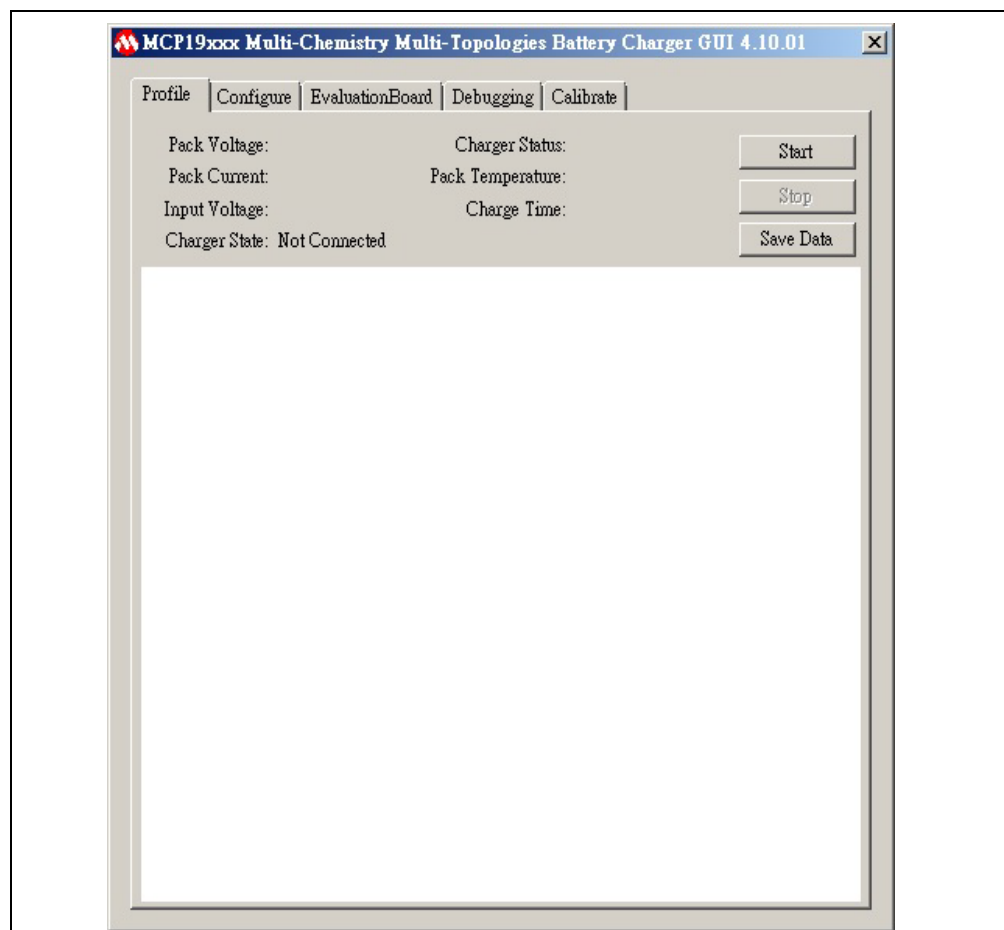

FIGURE 2-1: MCP19XXX Multi-Chemistry Multi-Topology Battery Charger GUI.

Chapter 3. Graphical User Interface

3.1 RUNNING THE MCP19125 FLYBACK BATTERY CHARGER EVALUATION BOARD

3.1.1 Setting up the GUI and the Board

1. Connect two banana-banana power cables from the power supply to the V_{IN} and GND jacks on the MCP19125 Flyback Battery Charger Evaluation Board. The board should be powered within the range of 12V-24V.
2. Connect a battery pack to the J3 header on the board, ensuring the polarity is correct. Take note of the type of battery, the number of cells, and the capacity (mAh), as these details will be needed to run the GUI.
3. Attach a PICKit Serial device to header J4 and connect to the computer through a USB. Ensure the PICKit Serial is powered and not in "Busy" status, as shown in Figure 3-1:

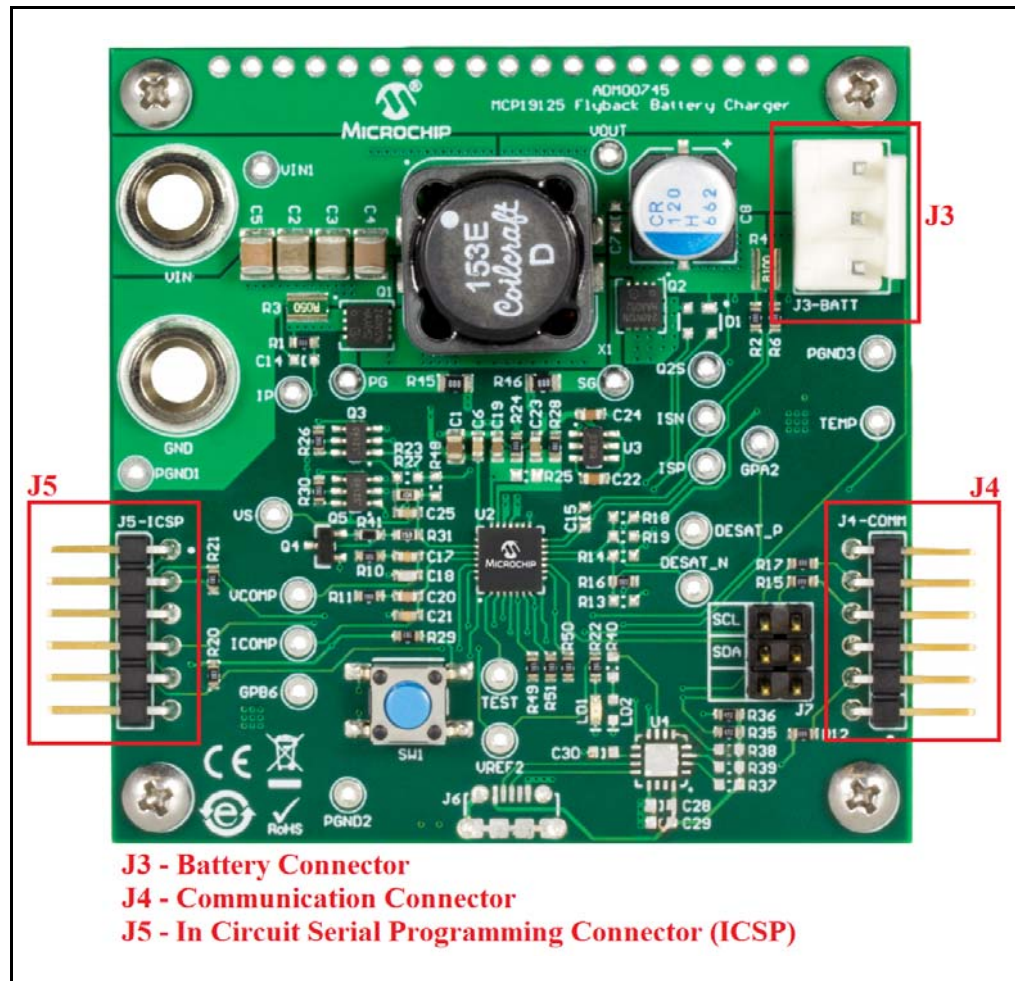

FIGURE 3-1: MCP19125 Flyback Battery Charger Evaluation Board with Power, Communication and Battery Connections.

3.1.2 Charge Configuration

1. The MCP19XXX Multi-Chemistry Multi-Topology Battery Charger GUI can be used for two different battery charger evaluation boards; ADM00513 - MCP19111 Buck Topology Battery Charger, and ADM00745 - MCP19125 Flyback Topology Battery Charger. Select ADM00745 on the **Evaluation Board** tab.
2. With the board powered, select a battery chemistry from the drop down menu of the **Configure** tab. The different chemistries require different charge profiles. Selecting a chemistry lets the GUI provide preset values for various charge parameters. Selecting a chemistry also blocks off certain parameters that can be controlled by the user to ensure safe and efficient charging.
3. Select a charge configuration based on the type of battery and charging rate. These parameters can also be changed in the **Configure** tab of the GUI.

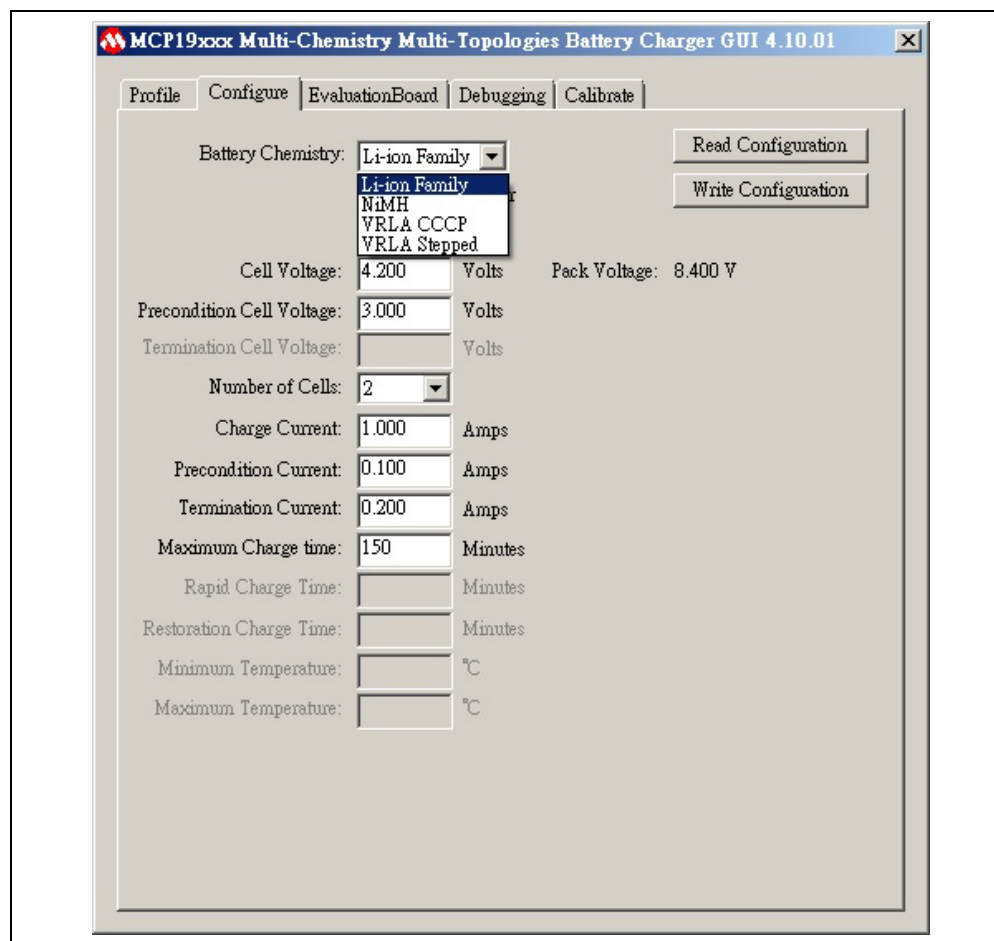

FIGURE 3-2: The GUI Configure Tab with Available Battery Chemistries.

4. If a battery has a thermistor, the user can select the **With Thermistor** check box to allow the MCP19125 to read temperature values, which are displayed numerically as well as graphed real-time in the **Profile** tab.
5. When the user has entered the desired parameters into the GUI, the **Write Configuration** button must be pressed to write the profile into the MCP19125's firmware. A **Read Configuration** button is also provided, which will read the current charge configuration from the firmware and load it into the GUI. If no configuration has been previously written, an error message is displayed.

3.1.3 Running a Charge Profile

TABLE 3-1: OTHER CONFIGURATION PARAMETERS

Parameter	Description
Cell Voltage	This parameter controls the rated voltage of each cell in the battery pack.
Precondition Cell Voltage	This parameter sets the voltage value at which the battery charger transitions from the Precondition Current mode to its Constant-Current mode. This transition is meant to protect the battery pack if the value is below the minimum value of the working voltage.
Termination Cell Voltage	This parameter controls the pack voltage value at which the battery charger ends the main charge phase and transitions to the Trickle Charge mode or turns off. This value is typically the maximum value of the specified working voltage range.
Rapid Charge/Charge Current	This parameter provides the current value applied to the battery pack by the charger during the main charging state. The charger implements either Rapid mode or Charge Current mode, depending on the battery chemistry selected.
Restoration/Precondition Current	For deeply discharged batteries, a small amount of restoration current is necessary to bring the battery pack voltage to a level that is safe to implement Rapid Charge Current mode or Charge Current mode. This parameter controls the current value applied during this stage of charging.
Trickle Charge Current	After the battery reaches termination cell voltage, the sudden decrease in current will lead to a drop in the pack voltage. The battery charger applies a trickle charge current controlled by this parameter for an allotted period of time to regulate the voltage at which the main charge cycle terminated.
Termination Current	For Li-Ion and VRLA CCCP chemistries that end their charge cycle in Constant-Voltage mode, the termination current parameter controls the current value at which the battery charger will end the charge cycle. The battery charger will slowly ramp down the charge current to this value and then turn off.
Number of Cells	Enter the number of cells for the attached battery. The system uses this to calculate the termination voltage.
Rapid Charge Time	This parameter sets the maximum time period during which the battery charger will run in the Rapid Charge mode.
Restoration Charge Time	This parameter sets the maximum time period during which the battery charger will apply restoration current to the battery.
Maximum Temperature	A protection feature for the battery that is only active when the With Thermistor check box is selected with a NiMH charge profile. The parameter sets the maximum temperature in degrees Celsius (°C) that the battery can reach before the battery charger shuts off completely.
Minimum Temperature	A protection feature for the battery that is only active when the With Thermistor check box is selected. The parameter sets the minimum temperature in degrees Celsius (°C) that the battery can drop before the battery charger shuts off completely.

Once the user has ensured the battery charger board is powered, programmed and configured properly, a charge profile can be defined. By selecting the Profile tab, the user can control running the charge profile and monitoring the charge status. At the top of the tab, the user can view the instantaneous values of the pack voltage, pack current, input voltage, and state of the charger.

At all times, the user can see whether the battery pack is charging or not. The battery charger board will also give error states, such as Over-Temperature (OT), Under Threshold Input Voltage (UT), or Over Threshold Input Voltage (OVT). The charger will display **Off** if the user attempts to run a charge, but the charger board is not currently running.

MCP19125 Flyback Battery Charger Evaluation Board User's Guide

Note that the MCP19125 Flyback Battery Charger Evaluation Board is shipped already programmed. Unless the user programs it themselves, the Charge Configuration is the only necessary user input.

When the battery is successfully charging, the Charger State will read different states based on the type of battery that is being charged. Examples of different charge states include "Precondition", "Constant-Current", "Constant-Voltage", "Rapid Charge", "Trickle", and "Off".

Enabling the charge can be toggled by selecting the **Start** and **Stop** buttons. The graphs on the lower half of the tab display real-time voltage and current, as well as a temperature profile if the **With Thermistor** check box was selected in the **Configure** tab. The GUI allows for the reporting of the various measured values in real time, so that the user can monitor if charge current and voltage are regulating correctly. The charge current limitations are defined by the following values:

- Minimum 0.1A
- Maximum 1A

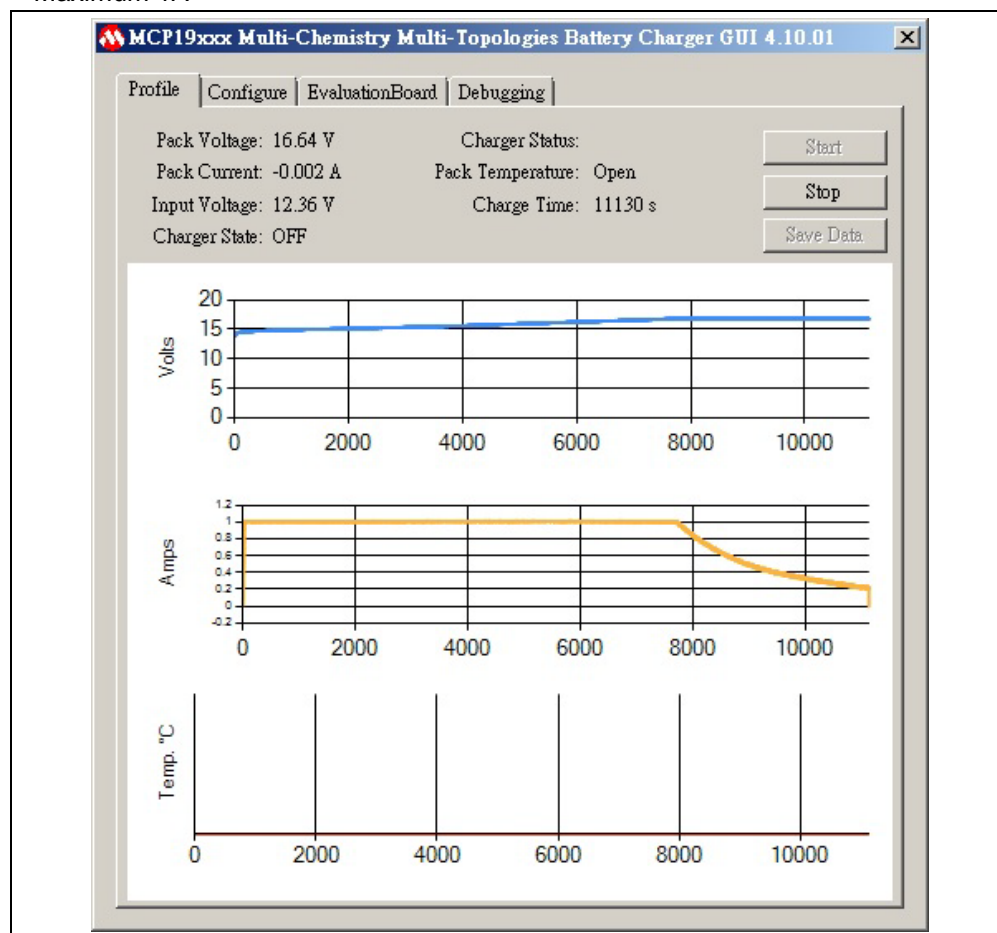

FIGURE 3-3: A Full Charge Profile.

3.1.4 Battery Chemistry Charge Profiles

Figure 3-3 – Figure 3-6 show examples of charge profiles.

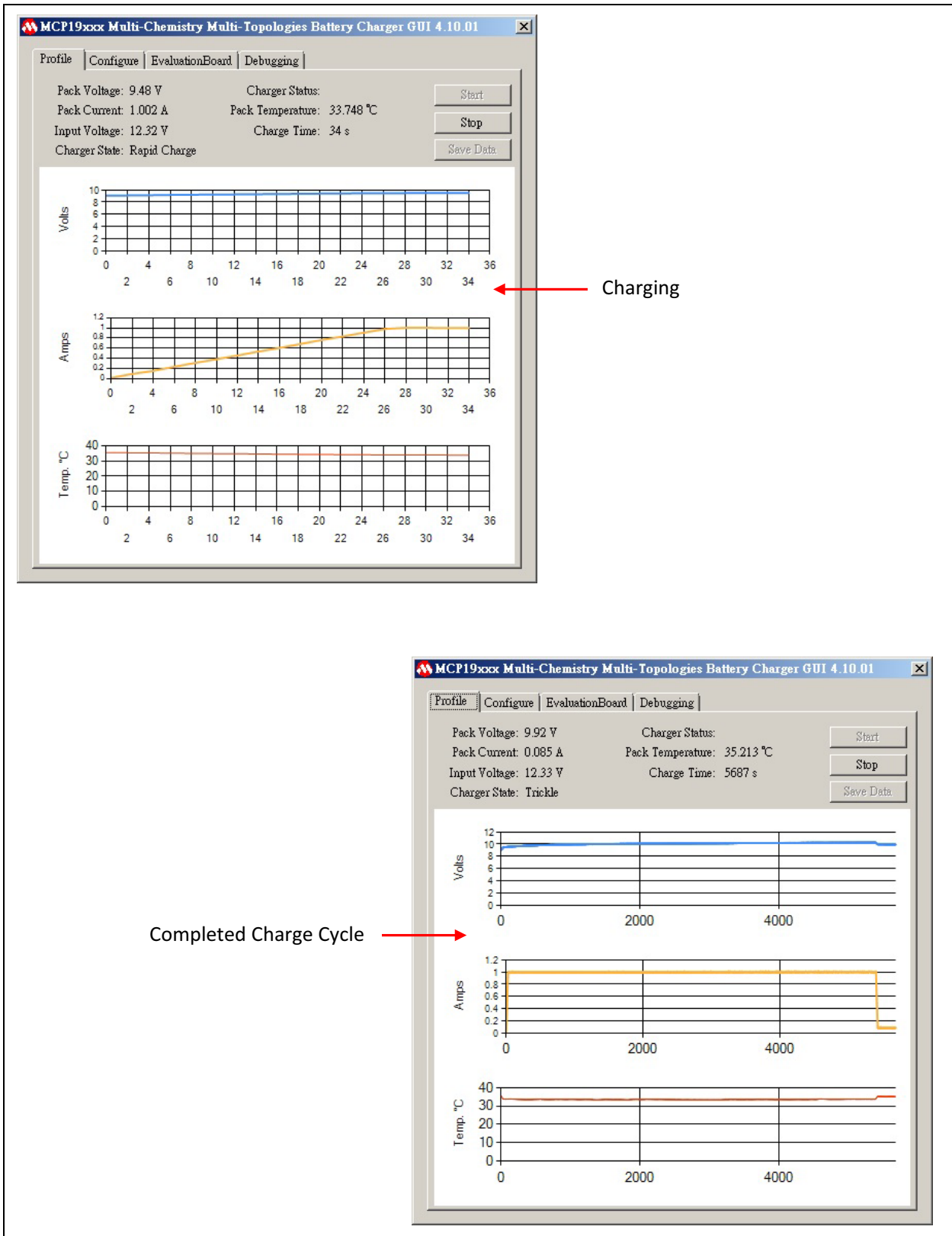

FIGURE 3-4: Charge Profile for NiMH Battery Pack (7-cell, 1.00A Charge Current).

MCP19125 Flyback Battery Charger Evaluation Board User's Guide

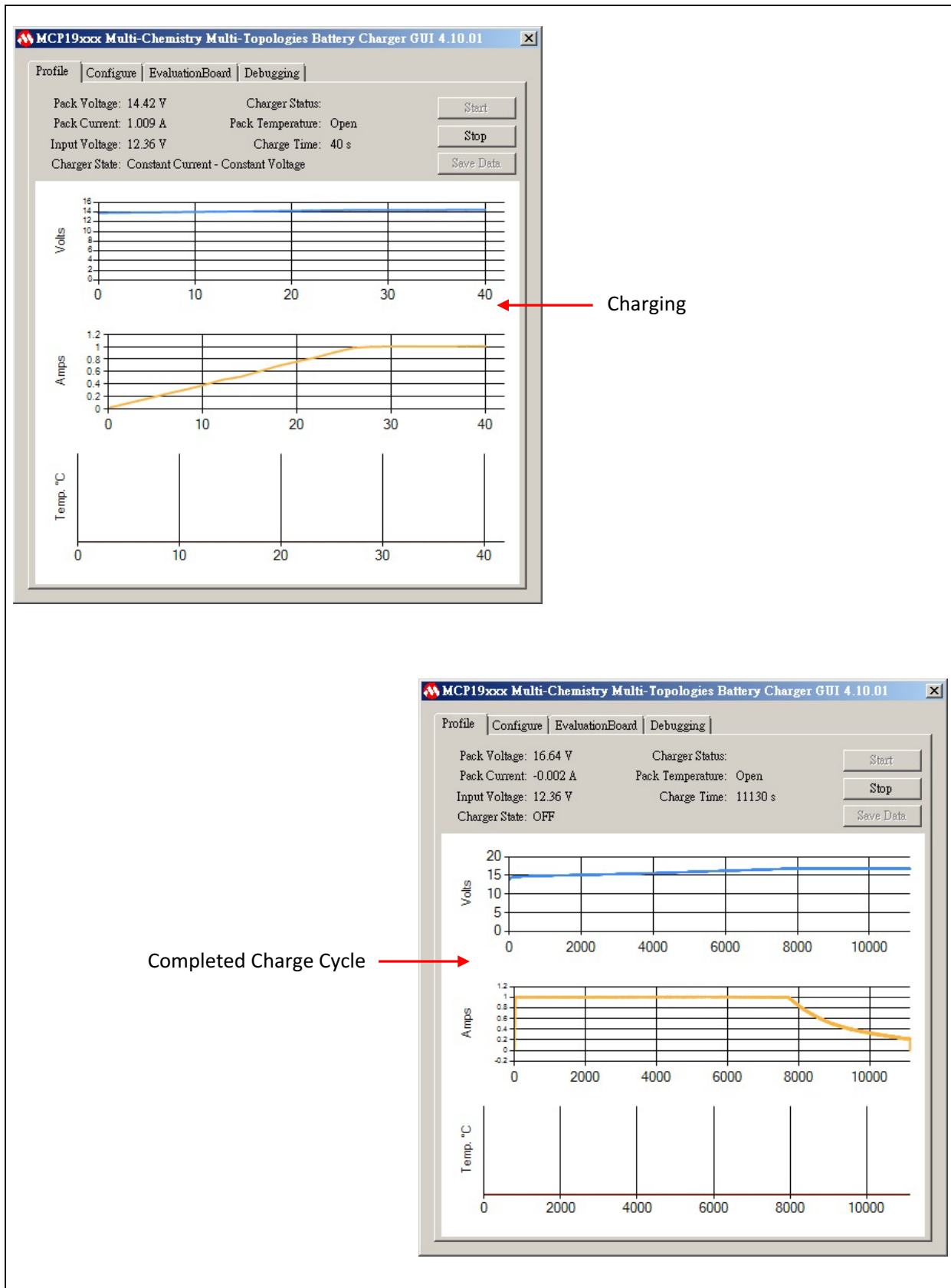

FIGURE 3-5: Charge Profile for Li-Ion Battery Pack (4-Cell, 1.00A Charge Current).

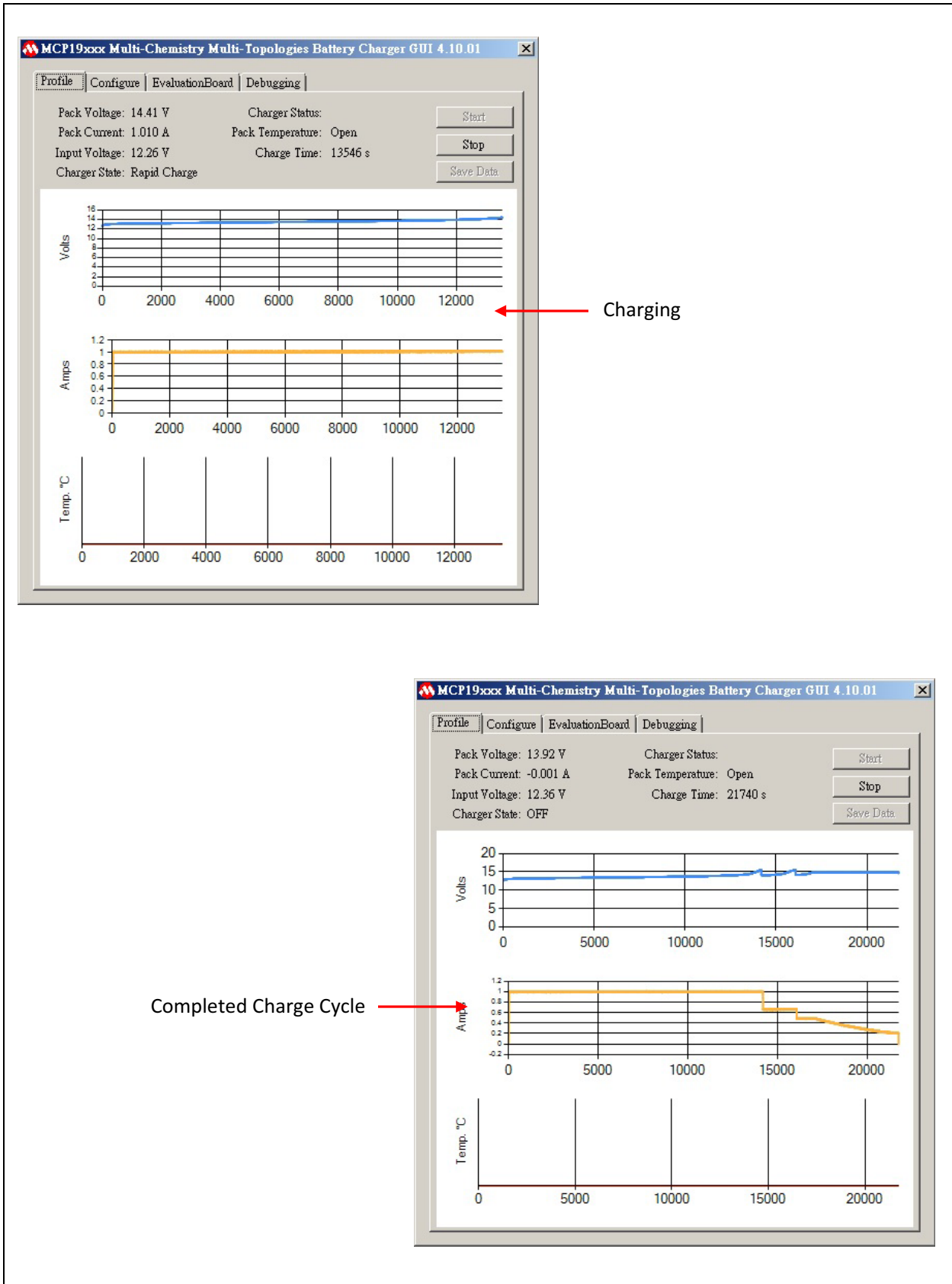

FIGURE 3-6: VRLA Step Charge Profile (6-Cell, 1.00A Charge Current).

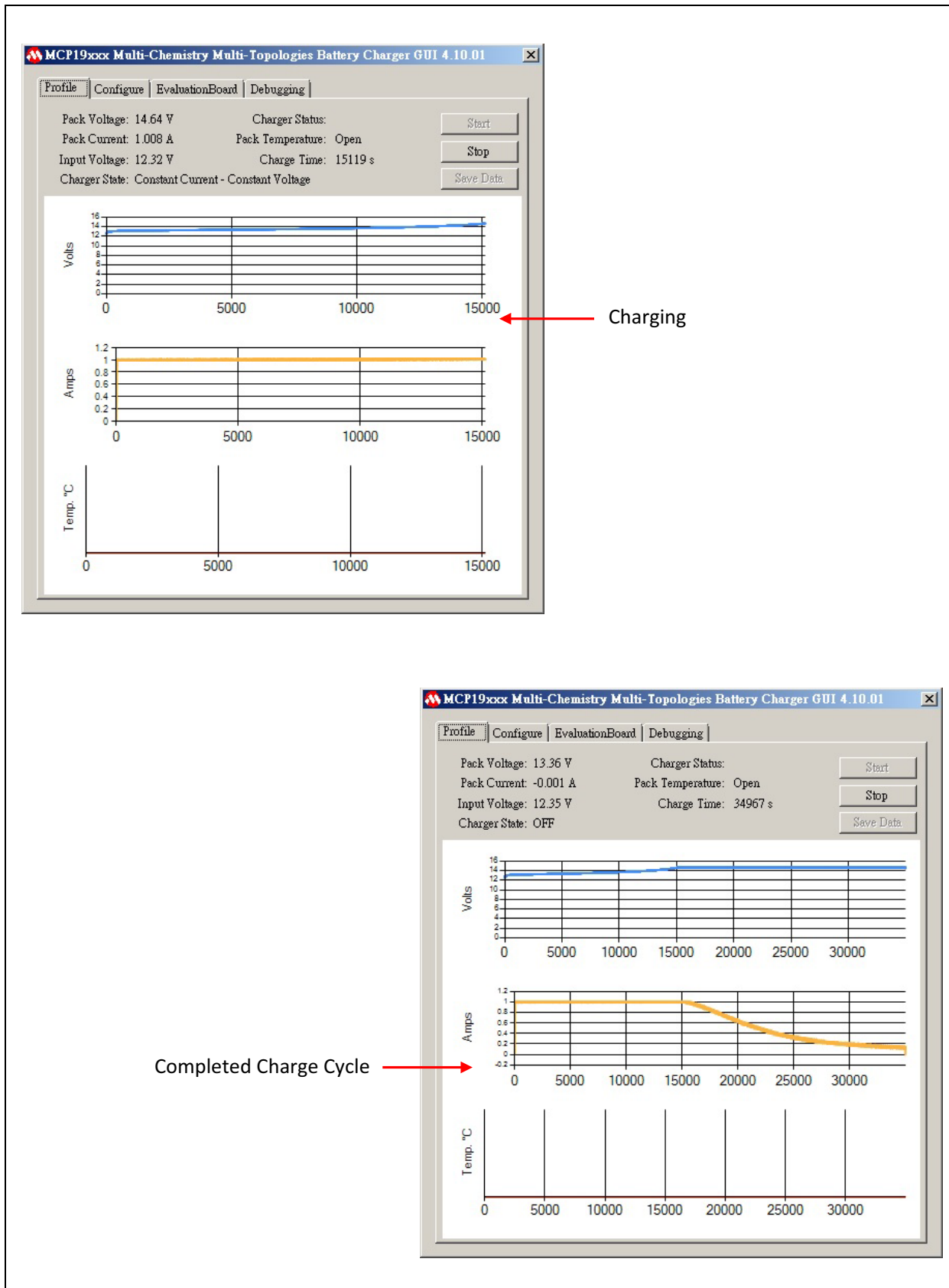

FIGURE 3-7: VRLA CCCP Charge Profile (6-Cell, 1.00A Charge Current).

3.2 PROGRAMMING THE MCP19125 FLYBACK BATTERY CHARGER EVALUATION BOARD

The MCP19125 Flyback Battery Charger Evaluation Board comes with a preprogrammed firmware installed. The following tools are required to reprogram the device:

- MPLAB X Integrated Development System (IDE) (Version 2.05 or later)
- MPLAB XC8 Compiler (Version 1.3 or later)
- MCP19125 Flyback Battery Charger Evaluation Board Firmware
- MCP19125 Flyback Battery Charger Evaluation Board
- PICkit 3 In-Circuit Debugger/Programmer

Follow the steps below to install all necessary software and start reprogramming the MCP19125 device:

1. If MPLAB X IDE is already installed, go to Step 2. If not, download MPLAB X IDE from www.microchip.com/mplabx and follow the MPLAB X IDE installation instructions.
2. If an XC8 compatible compiler or an equivalent is already installed in MPLAB X IDE, go to Step 3. If not, a free version of Microchip's XC8 is available for download on www.microchip.com/mplabxc. The XC8 user guide, installation instructions and download links are available on this page.
3. Download the MCP19125 Flyback Battery Charger Evaluation Board Firmware archive (*.zip) from www.microchip.com/mcp19125 under "Documentation & Software".
4. Unzip the MCP19125 Flyback Battery Charger Evaluation Board Firmware archive. Place the MCP19125BatteryCharger.X project folder in the desired location.
5. Power up the MCP19125 Flyback Battery Charger Evaluation Board.
6. Connect the PICkit 3 In-Circuit Debugger to the MCP19125 Flyback Battery Charger Evaluation Board via the 6-pin connector, J5.
7. Open MPLAB X IDE to load the MCP19125 Flyback Battery Charger Evaluation Board Firmware. From the File menu, select "Open Project..."
8. Browse for the location of the extracted firmware. Select "MCP19125 Battery-Charger.X" from the list, then check the "Open as Main Project" option. Click on the **Open Project** button to complete loading the file.

Once the project is opened, click on the Make and Program Device Main Project button on the toolbar to program the device. Wait until the programming process is complete.

NOTES:



Appendix A. Schematic and Layouts

A.1 INTRODUCTION

This appendix contains the following schematics and layouts for the MCP19125 Flyback Battery Charger Evaluation Board:

- Board – Schematic 1
- Board – Schematic 2
- Board – Top Copper and Silk Layer
- Board – Top Copper
- Board – Mid-Layer 1
- Board – Mid-Layer 2
- Board – Bottom Copper
- Board – Bottom Copper and Silk Layer
- Board – Bottom Silk Layer

A.2 BOARD – SCHEMATIC 1

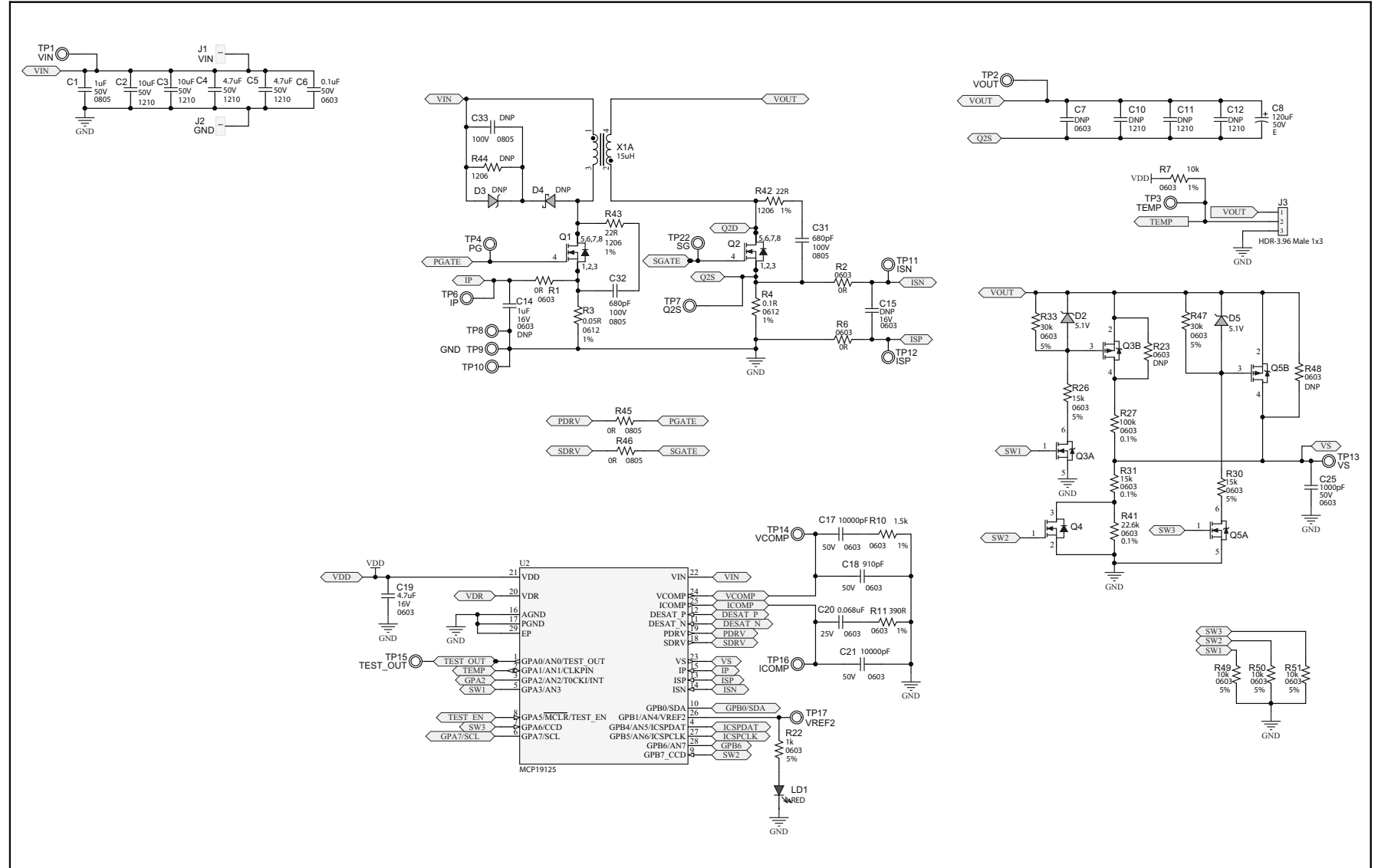

A.3 BOARD – SCHEMATIC 2

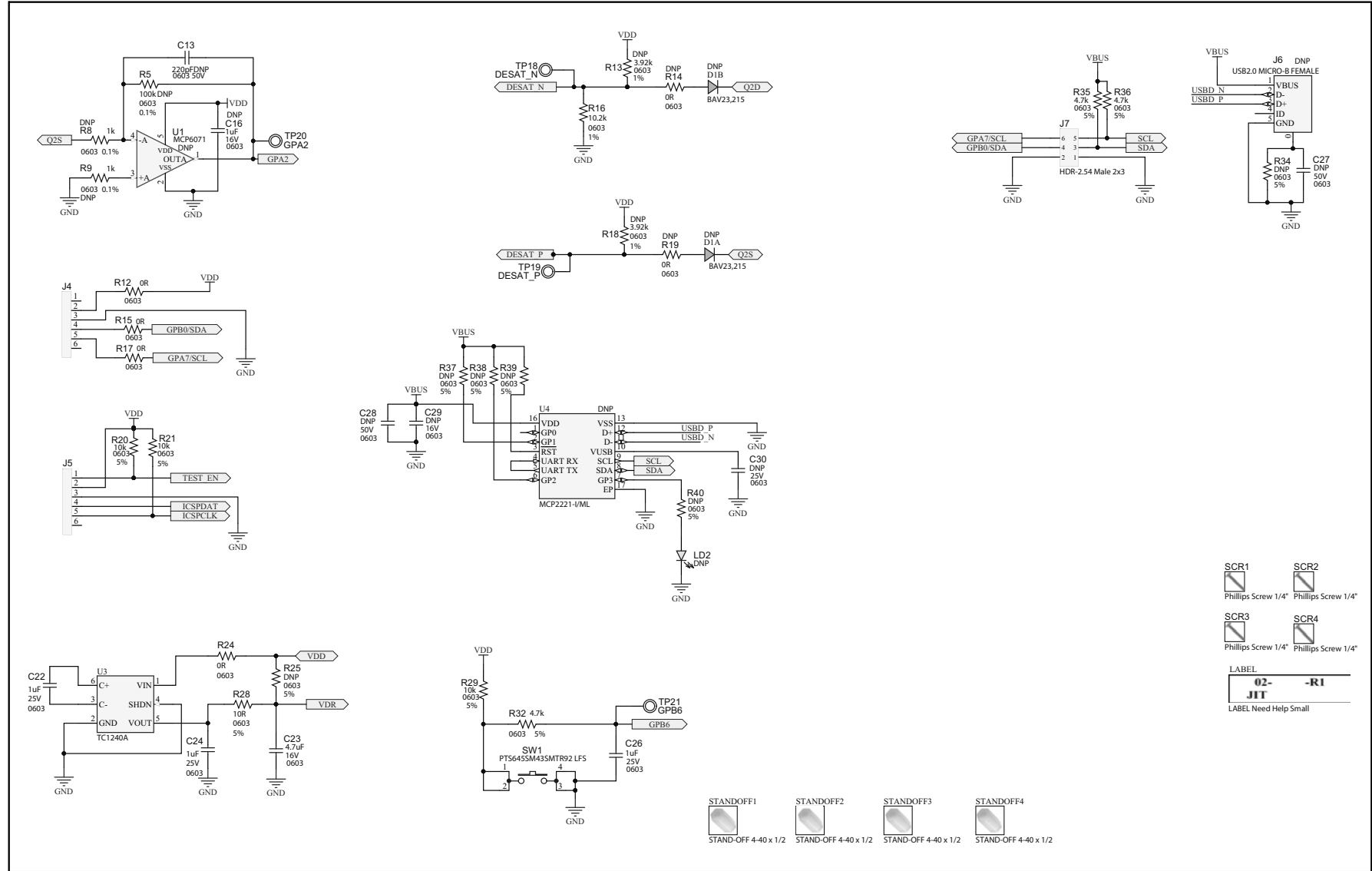

- SCR1 Phillips Screw 1/4"
 - SCR2 Phillips Screw 1/4"
 - SCR3 Phillips Screw 1/4"
 - SCR4 Phillips Screw 1/4"
- LABEL
- | | |
|-----|-----|
| 02- | -R1 |
|-----|-----|
- LABEL Need Help Small

- STANDOFF1 STAND-OFF 4-40 x 1/2
- STANDOFF2 STAND-OFF 4-40 x 1/2
- STANDOFF3 STAND-OFF 4-40 x 1/2
- STANDOFF4 STAND-OFF 4-40 x 1/2

MCP19125 Flyback Battery Charger Evaluation Board User's Guide

A.4 BOARD – TOP SILK LAYER

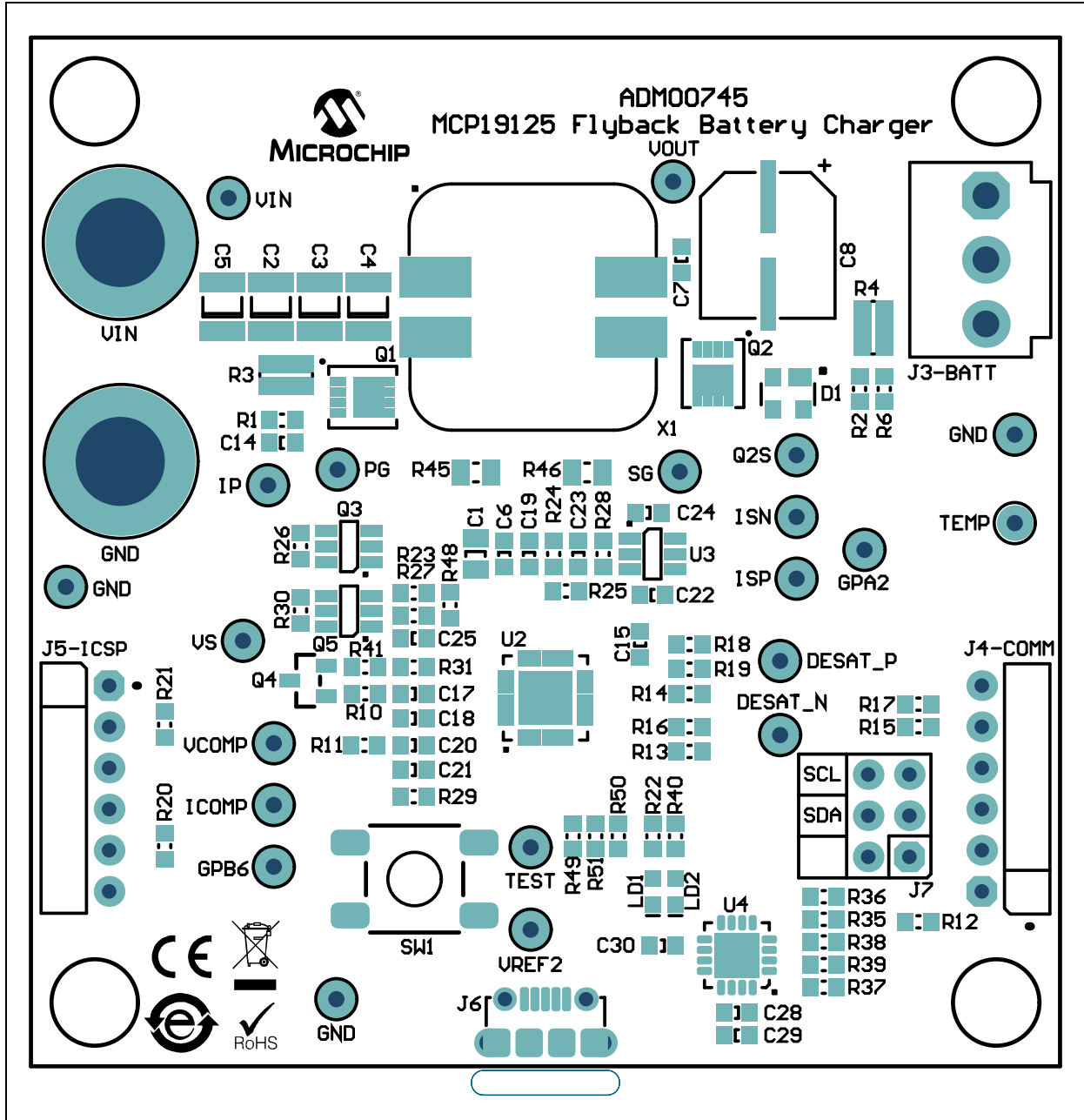

A.5 BOARD – TOP COPPER AND SILK LAYER

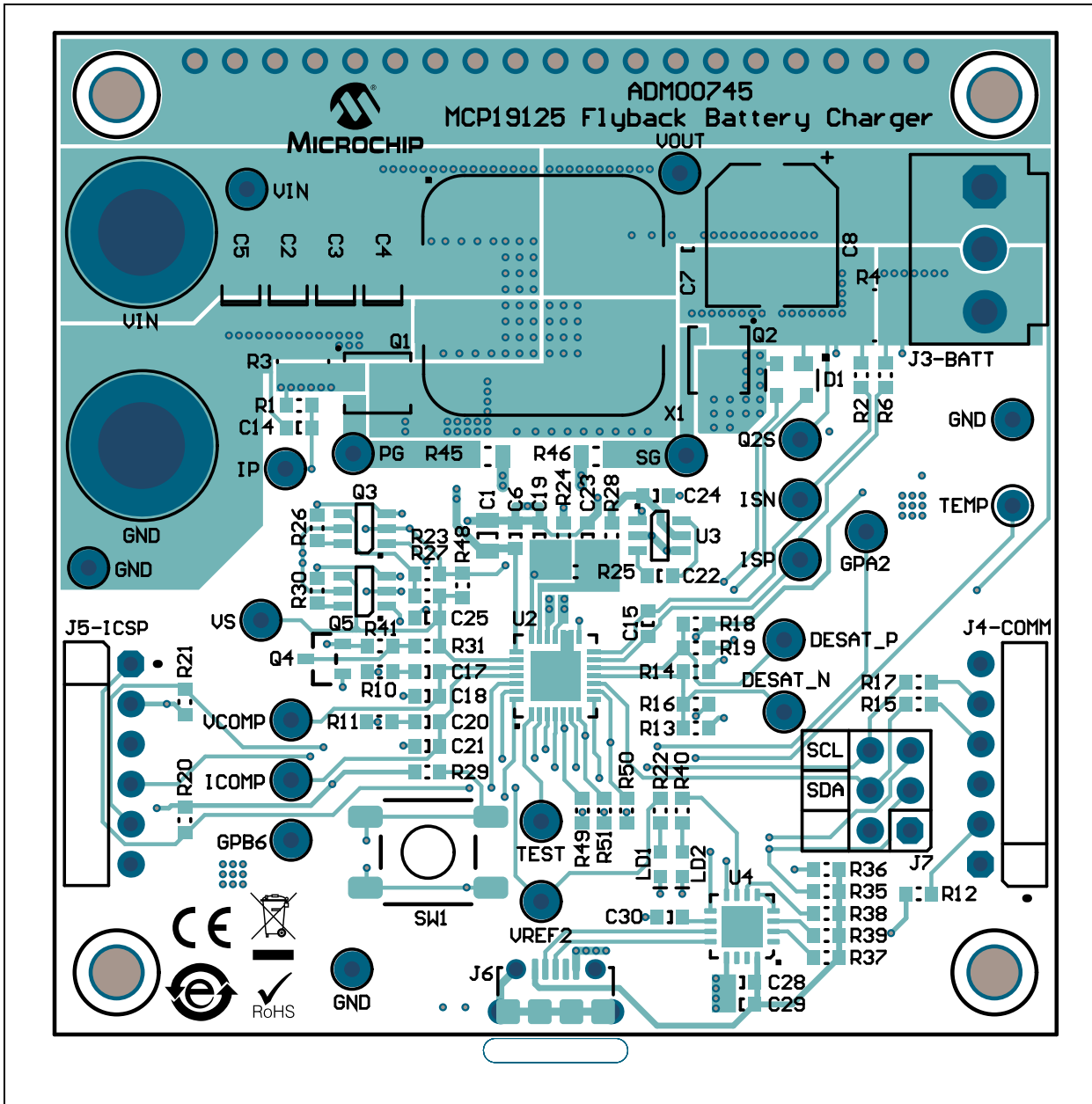

A.6 BOARD – TOP COPPER

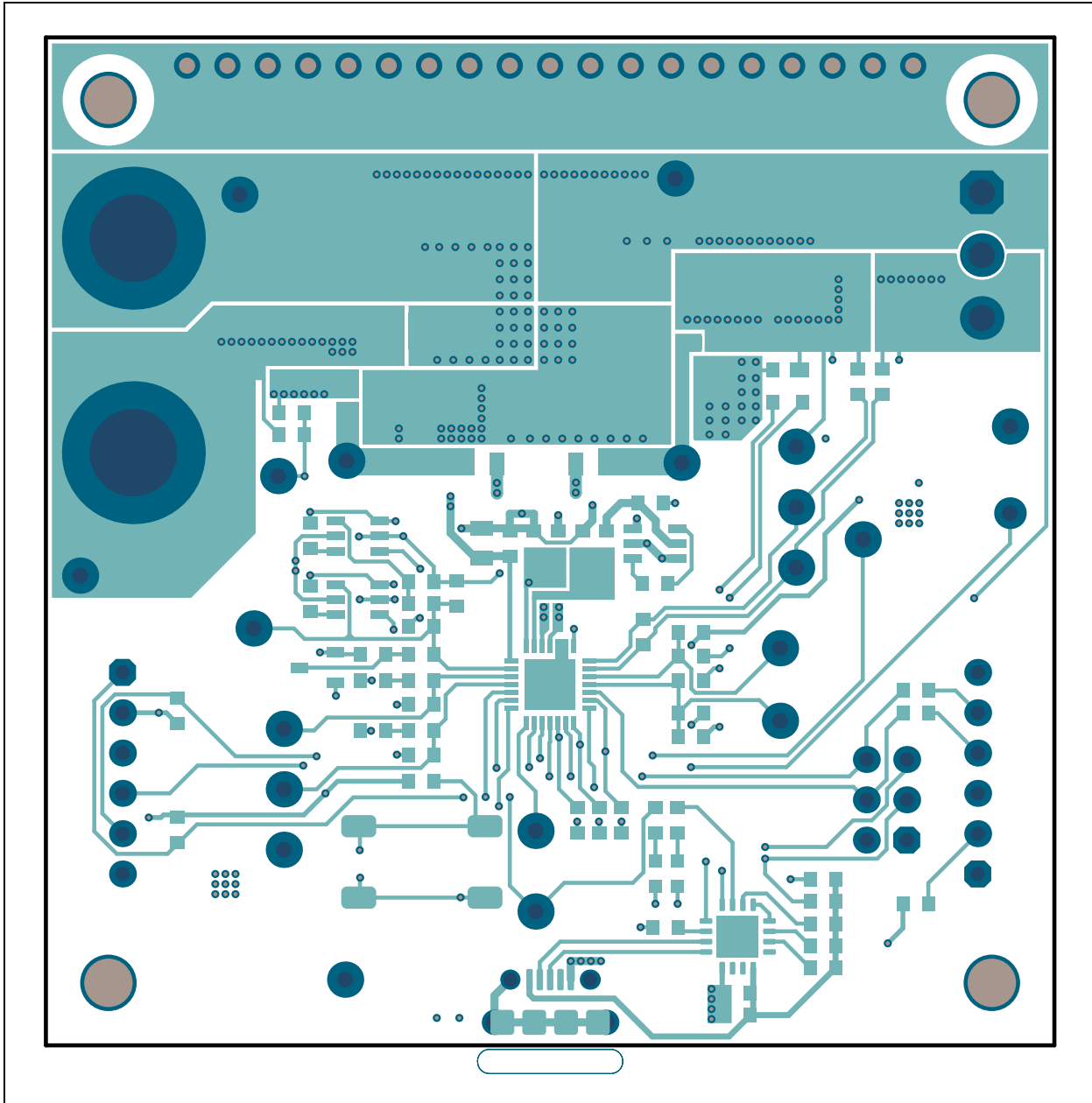

A.7 BOARD – MID-LAYER 1

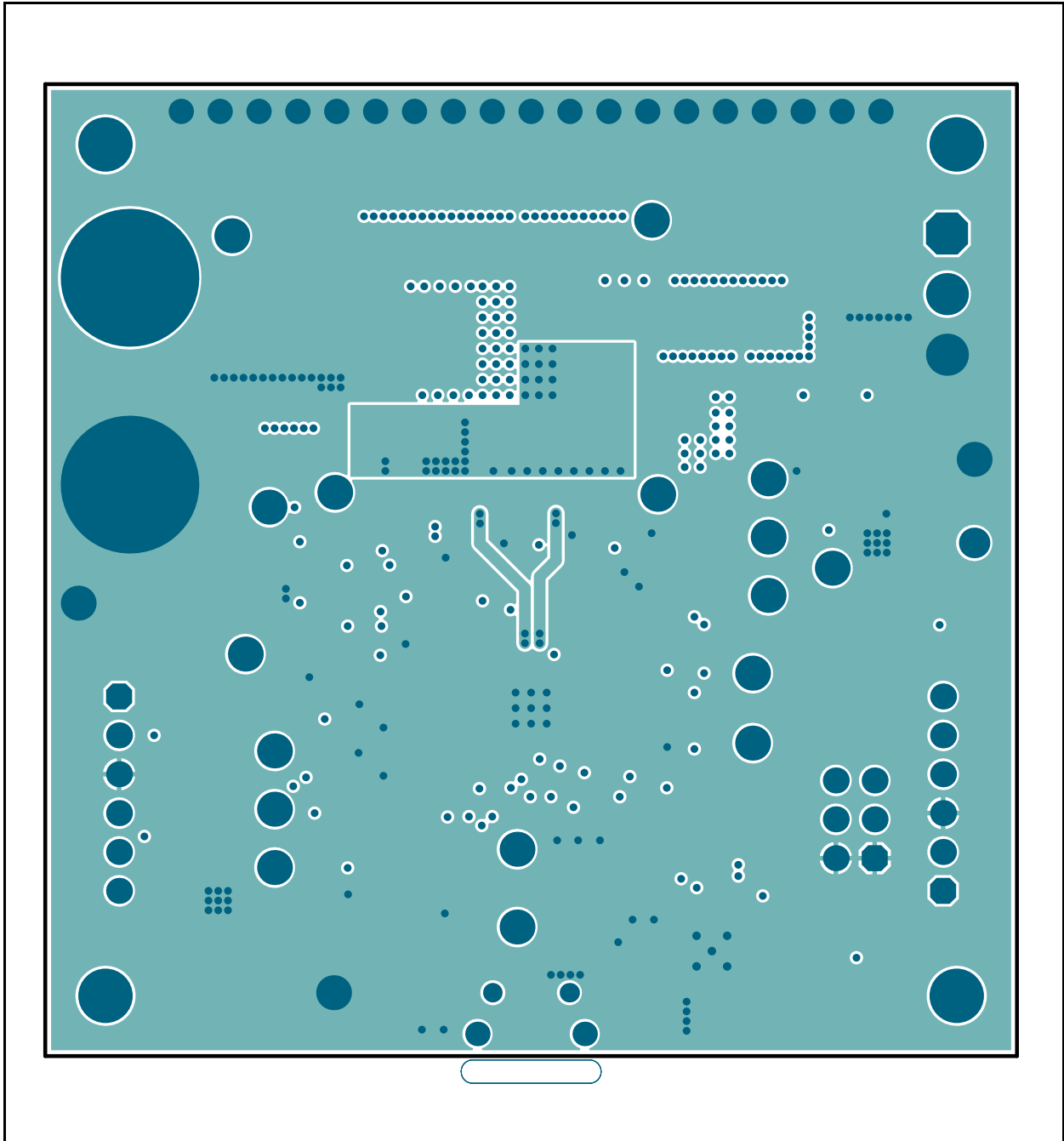

A.8 BOARD – MID-LAYER 2

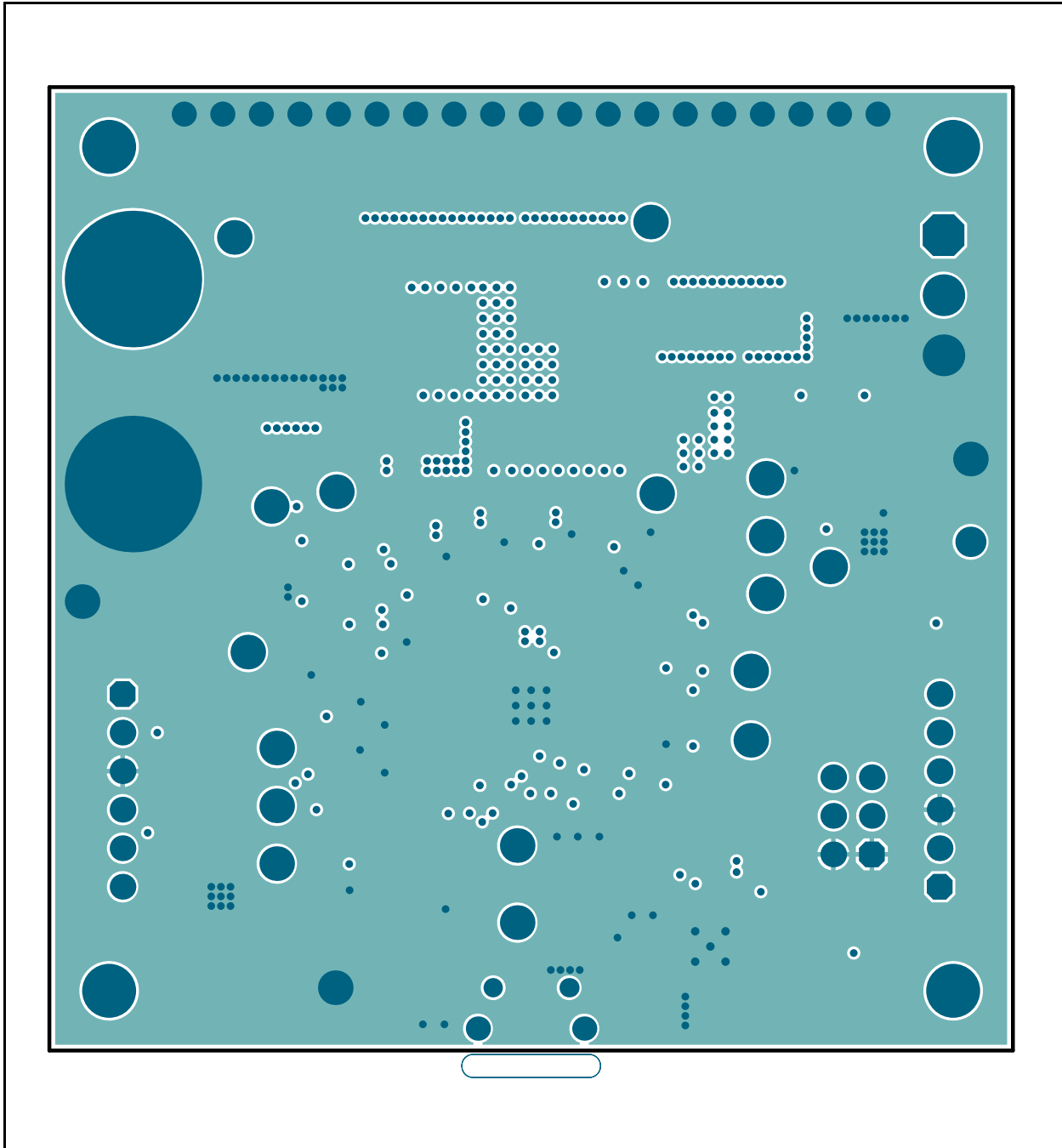

A.9 BOARD – BOTTOM COPPER

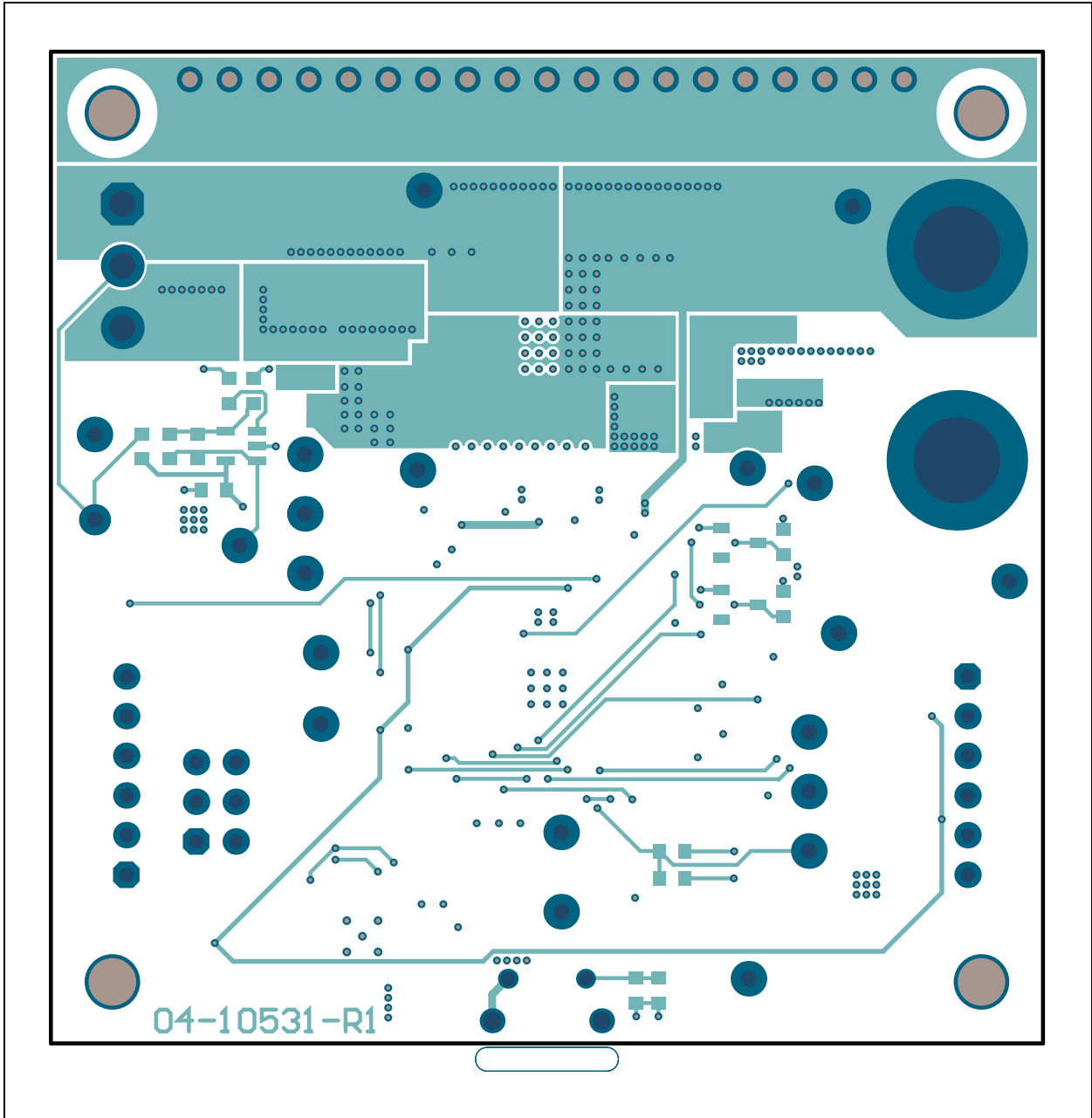

A.10 BOARD – BOTTOM COOPER AND SILK LAYER

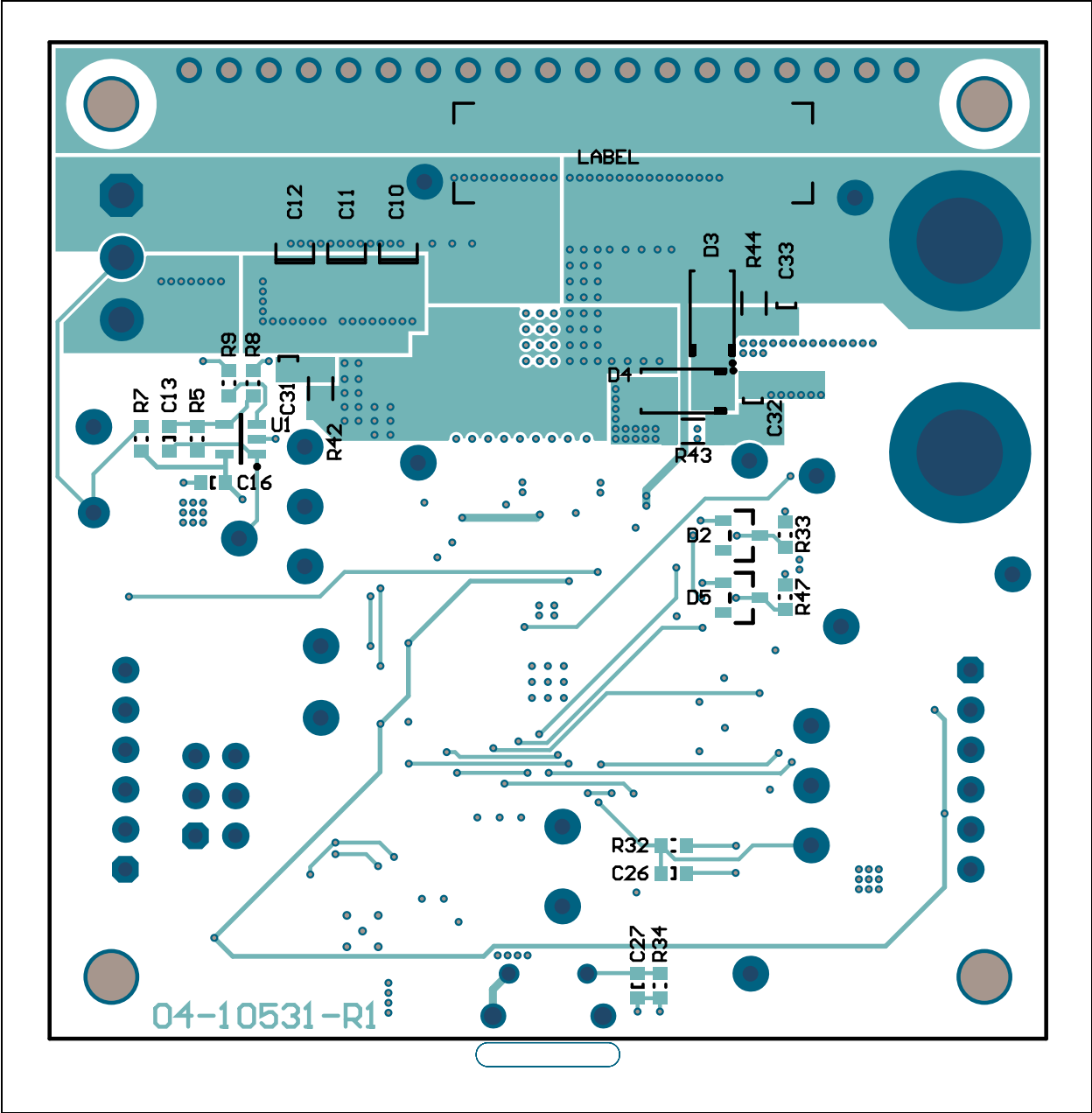

A.11 BOARD – BOTTOM SILK LAYER

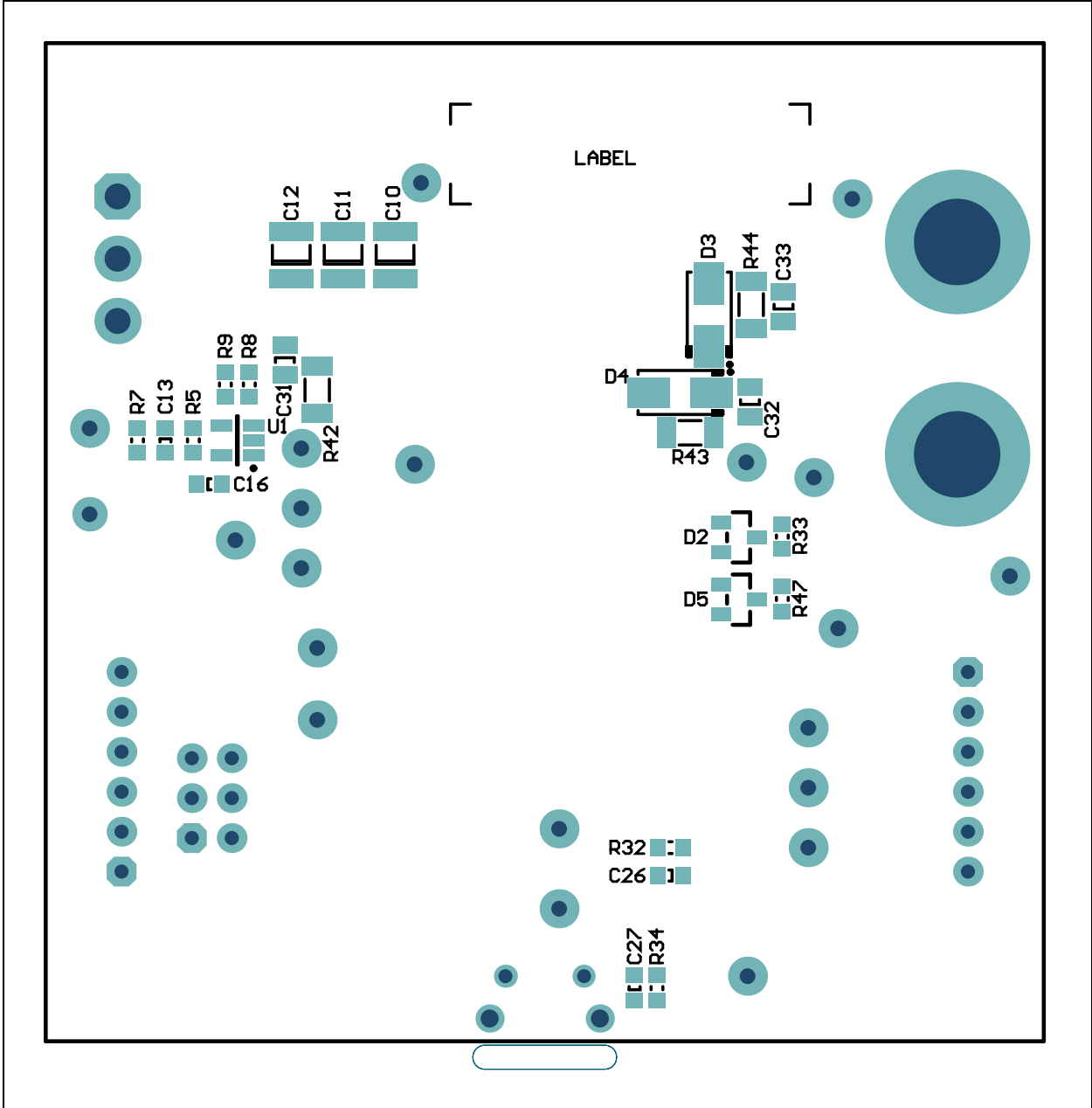

NOTES:

Appendix B. Bill of Materials (BOM)

TABLE B-1: BILL OF MATERIALS (BOM)

Qty.	Reference	Description	Manufacturer	Part Number
1	C1	Cap. cer. 1 μ F 50V 10% X7R SMD 0805	Murata Electronics North America, Inc.	GRM21BR71H105KA12L
2	C2, C3	Cap. cer. 10 μ F 50V 20% X7S SMD 1210	TDK Corporation	C3225X7S1H106M
2	C4, C5	Cap. cer. 4.7 μ F 50V 10% X7R SMD 1210	Murata Electronics North America, Inc.	GRM32ER71H475KA88L
1	C6	Cap. cer. 0.1 μ F 50V 20% Y5V SMD 0603	AVX Corporation	06035G104ZAT2A
1	C8	Cap. ALU 120 μ F 50V 20% SMD E	Nichicon	PCR1H121MCL2GS
2	C17, C21	Cap. cer. 10000 pF 50V 10% X7R SMD 0603	AVX Corporation	06035G104ZAT2A
1	C18	Cap. cer. 910 pF 50V 5% NP0 SMD 0603	Murata Electronics North America, Inc.	GRM1885C1H911JA01D
2	C19, C23	Cap. cer. 4.7 μ F 16V 10% X5R SMD 0603	TDK Corporation	C1608X5R1C475K080ACv
1	C20	Cap. cer. 0.068 μ F 25V 10% X8R SMD 0603	TDK Corporation	C1608X8R1E683K
3	C22, C24, C26	Cap. cer. 1 μ F 25V 10% X7R SMD 0603	TDK Corporation	CGA3E1X7R1E105K080AC
1	C25	Cap. cer. 1000 pF 50V 20% X7R SMD 0603	Panasonic [®] - ECG	ECJ-1VB1H102K
2	C31, C32	Cap. cer. 680 pF 100V 5% NP0 SMD 0805	KEMET	C0805C681J1GACTU
2	D2, D5	Diode Zener BZX84-C5V1 5.1V 250 mW SOT-23-3	NXP Semiconductors	BZX84-C5V1,215
2	J1, J2	Conn. jack banana 4.5 mm female TH. vert.	Keystone Electronics	575-8
1	J3	Conn. header 3.96 mm male 1x3 tin lock 7.7 MH TH. vert.	TE Connectivity AMP Connectors	1-1123723-3
2	J4, J5	Conn. hdr.-2.54 male 1x6 gold 5.84 MH TH. R/A	FCI	68016-106HLF
1	J7	Conn. hdr.-2.54 male 2x3 gold 5.84 MH TH. vert.	Samtec, Inc.	TSW-103-08-L-D
1	LABEL	Label assy. w/rev level (small modules) per MTS-0002		
1	LD1	Didoe LED red 1.8V 40 mA 10 mcd clear SMD 0603	Lite-On [®] Technology Corporation	LTST-C190KRKT
1	PCB	Printed Circuit Board - MCP19125 Flyback Battery Charger Evaluation Board		04-10531
2	Q1, Q2	Trans. FET N-Ch. BSZ240N12NS3 G 120V 37A 66W TSDSON-8	Infineon Technologies AG	BSZ240N12NS3 GCT-ND
2	Q3, Q5	Trans FET dual N+P SI3552DV-T1-GE3 30V, -30V 2.5A, -1.8A 1.15W SOT-23-6	Vishay Siliconix	SI3552DV-T1-GE3
1	Q4	Trans. FET N-Ch. FDV301N 25V 220 mA 350 mW SOT-23-3	Fairchild Semiconductor [®]	FDV301N

Note 1: The components listed in this Bill of Materials are representative of the PCB assembly. The released BOM used in manufacturing uses all RoHS-compliant components.

MCP19125 Flyback Battery Charger Evaluation Board User's Guide

TABLE B-1: BILL OF MATERIALS (BOM) (CONTINUED)

Qty.	Reference	Description	Manufacturer	Part Number
7	R1, R2, R6, R12, R15, R17, R24	Resistor TKF. 0R 1/10W SMD 0603	Panasonic® - BSG	ERJ-3GSY0R00V
1	R3	Resistor TF. 0.05R 1% 1W SMD 0612	Susumu Co., LTD.	PRL1632-R050-F-T1
1	R4	Resistor TF. 0.1R 1% 1W SMD 0612	Susumu Co., LTD.	L1632-R100-F-T5
1	R7	Resistor TKF. 10k 1% 1/10W SMD 0603	ROHM Semiconductor	MCR03EZPFX1002
1	R10	Resistor TKF. 1.5k 1% 1/10W SMD 0603	Panasonic - BSG	ERJ-3EKF1501V
1	R11	Resistor TKF. 390R 1% 1/10W SMD 0603	Panasonic - BSG	ERJ-3EKF3900V
1	R16	Resistor TKF. 10.2k 1% 1/10W SMD 0603	Yageo Corporation	RC0603FR-0710K2L
6	R20, R21, R29, R49, R50, R51	Resistor TKF. 10k 5% 1/10W SMD 0603	Panasonic - BSG	ERJ-3GEYJ103V
1	R22	Resistor TKF. 1k 5% 1/10W SMD 0603	Panasonic - BSG	ERJ-3GEYJ102V
2	R26, R30	Resistor TKF. 15k 5% 1/10W SMD 0603	Panasonic - BSG	ERJ-3GEYJ153V
1	R27	Resistor TF. 100k 0.1% 1/10W SMD 0603	Panasonic - ECG	ERA-3AEB104V
1	R28	Resistor TKF. 10R 5% 1/10W SMD 0603	Panasonic - BSG	ERJ-3GEYJ100V
1	R31	Resistor SMD. 15K Ω 0.1% 1/10W 0603	Panasonic - ECG	ERA-3AEB153V
3	R32, R35, R36	Resistor TKF. 4.7k 5% 1/10W SMD 0603	Panasonic - BSG	ERJ-3GEYJ472V
2	R33, R47	Resistor TKF. 30k 5% 1/10W SMD 0603	Panasonic - BSG	ERJ-3GEYJ303V
1	R41	Resistor TF. 22.6K 0.1% 1/10W SMD 0603	Panasonic - ECG	ERA-3AEB2262V
2	R42, R43	Resistor 22 Ω 1/4W 1% 1206 SMD	Panasonic - ECG	ERJ-8ENF22R0V
2	R45, R46	Resistor TKF 0R 1/8W SMD 0805	Panasonic - BSG	ERJ-6GEY0R00V
4	SCR1, SCR2, SCR3, SCR4	Machine screw pan Phillips 4-40	Keystone Electronics	9900
4	STANDOFF1, STANDOFF2, STANDOFF3, STANDOFF4	Mech. HW. Stand-off F-F 4-40 nylon 1/2	Keystone Electronics	1902C
1	SW1	Switch tact. SPST 12V 50 mA PTS645SM43SMTR92 LFS SMD	C&K Components	PTS645SM43SMTR92 LFS
1	U2	Microchip Analog PWM controller 2 MHz MCP19125-E/MQ QFN-28	Microchip Technology Inc.	MCP19125-E/MQ
1	U3	Microchip Analog charge pump 5V - 11V TC1240AECSTR SOT-23-6	Microchip Technology Inc.	TC1240AECSTR
1	X1	Inductor dual 15 μ H 4.5A 20% SMD MSD1583	Coilcraft	MSD1583-153MEB

Note 1: The components listed in this Bill of Materials are representative of the PCB assembly. The released BOM used in manufacturing uses all RoHS-compliant components.

TABLE B-2: BILL OF MATERIALS (BOM) - DO NOT POPULATE

Qty.	Reference	Description	Manufacturer	Part Number
0	C7	Cap. cer. 0.1 μ F 50V 20% X7R SMD 0603	TDK Corporation	C1608X7R1H104M
0	C10, C11, C12	Cap. cer. 2.2 μ F 100V 10% X7R SMD 1210	KEMET	C1210C225K1RACTU
0	C13	Cap. cer. 220 pF 50V 5% NP0 SMD 0603	KEMET	C0603C221J5GACTU
0	C14, C15, C16	Cap. cer. 1 μ F 16V 10% X5R SMD 0603	AVX Corporation	0603YD105KAT2A
0	C27, C28	Cap. cer. 0.1 μ F 50V 20% Y5V SMD 0603	AVX Corporation	06035G104ZAT2A
0	C23, C29	Cap. cer. 4.7 μ F 16V 10% X5R SMD 0603	TDK Corporation	C1608X5R1C475K080ACv
0	C30	Cap. cer. 1 μ F 25V 10% X7R SMD 0603	TDK Corporation	CGA3E1X7R1E105K080AC
0	C33	Cap. cer. 680 pF 100V 5% NP0 SMD 0805	KEMET	C0805C681J1GACTU
0	D1	Diode Rectifier Arr. BAV23, 215 1V 225 mA 200V SMD SOT-143B	NXP Semiconductors	BAV23,215
0	D3	Diode TVS SMAJ90A 90VWM 400W SMD DO-214AC SMA	Littelfuse®	SMAJ90A
0	D4	Diode Sctky. STPS2H100 790 mV 2A 100V DO-214AC_SMA	STMicroelectronics	STPS2H100A
0	J6	Conn. USB 2.0 Micro-B female TH/SMD R/A	FCI	10118194-0001LF
0	LD2	Diode LED yellow 2.1V 20 mA 6 mcd clear SMD 0603	Lite-On Technology Corporation	LTST-C190YKT
0	TP1, TP2, TP3, TP4, TP6, TP7, TP8, TP9, TP10, TP11, TP12, TP13, TP14, TP15, TP16, TP17, TP18, TP19, TP20, TP21, TP22	Misc., test point multi-purpose mini black	Keystone Electronics Corp.	5001
0	R5	Res. TF. 100k 0.1% 1/10W SMD 0603	Panasonic - ECG	ERA-3AEB104V
0	R8, R9	Res. TF. 1k 0.1% 1/10W SMD 0603	Panasonic - ECG	ERA-3AEB102V
0	R13, R18	Res. TKF. 3.92k 1% 1/10W SMD 0603	Panasonic - BSG	ERJ-3EKF3921V
0	R14, R19, R23, R48	Res. TKF. 0R 1/10W SMD 0603	Panasonic - BSG	ERJ-3GSY0R00V
0	R25	Res. TKF. 10R 5% 1/10W SMD 0603	Panasonic - BSG	ERJ-3GEYJ100V
0	R34	Resistor MF 330R 5% 1/16W SMD 0603	Panasonic - ECG	ERA-V33J331V
0	R37, R38, R39	Resistor TKF. 4.7k 5% 1/10W SMD 0603	Panasonic - BSG	ERJ-3GEYJ472V
0	R40	Resistor TKF. 1k 5% 1/10W SMD 0603	Panasonic - BSG	ERJ-3GEYJ102V
0	R44	Res. 22 Ω 1/4W 1% 1206 SMD	Panasonic - ECG	ERJ-8ENF22R0V
0	U1	Microchip Analog op amp 1-Ch 1.2 MHz MCP6071T-E/OT SOT-23-5	Microchip Technology Inc.	MCP6071T-E/OT
0	U4	Microchip interface USB I ² C UART MCP2221-I/ML QFN-16	Microchip Technology Inc.	MCP2221-I/ML

Note 1: The components listed in this Bill of Materials are representative of the PCB assembly. The released BOM used in manufacturing uses all RoHS-compliant components.

MCP19125 Flyback Battery Charger Evaluation Board User's Guide

NOTES:

Appendix C. Charge Profile Block Diagrams

C.1 INTRODUCTION

Figures C-1– C-16 show block diagrams for the various charge profiles. The block diagrams show the flow of logic that enables the MCP19125 to control the charge cycle for efficient battery charging.

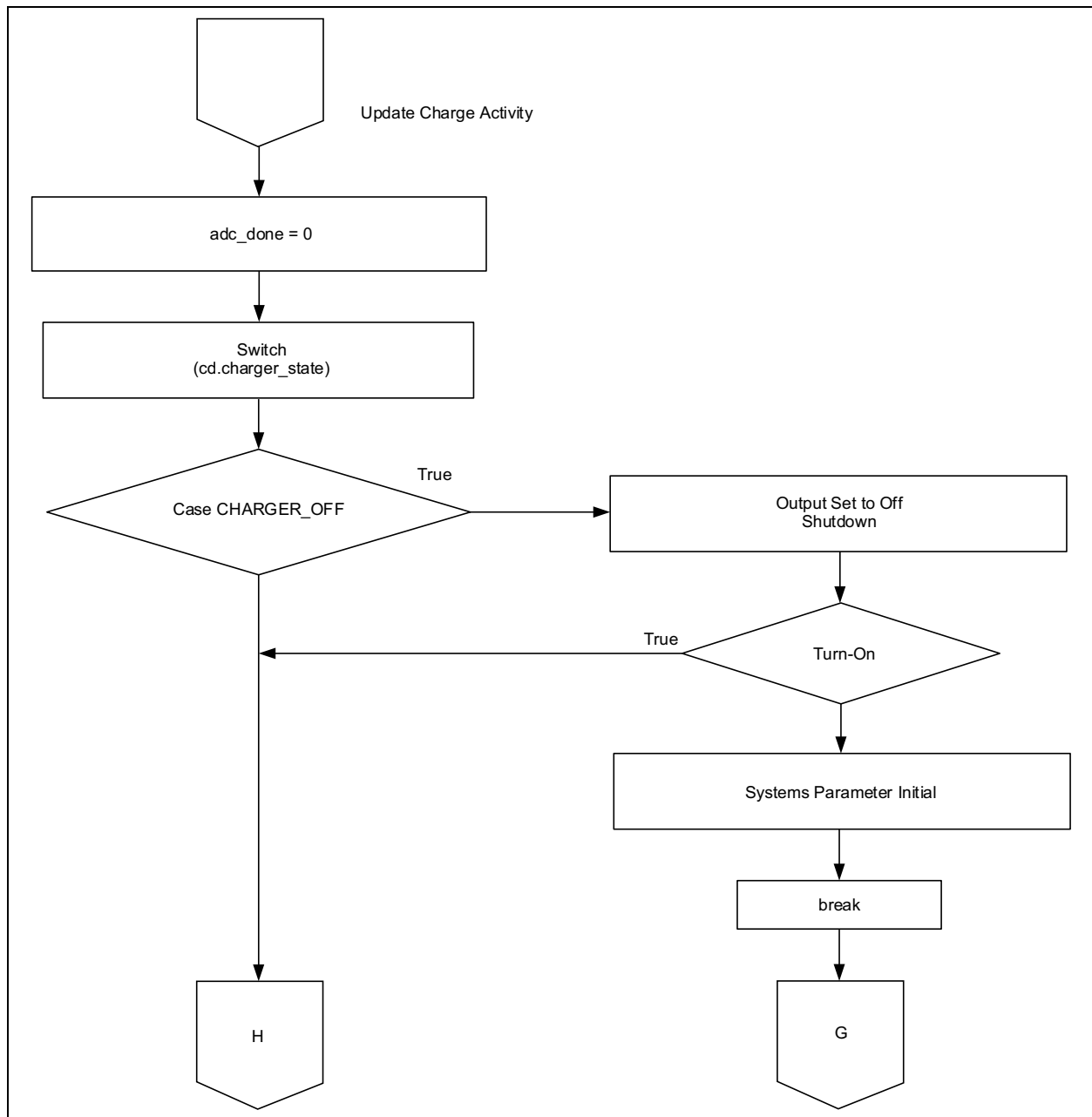

FIGURE C-1: Block Diagram of Battery Charger OFF-to-ON Logic.

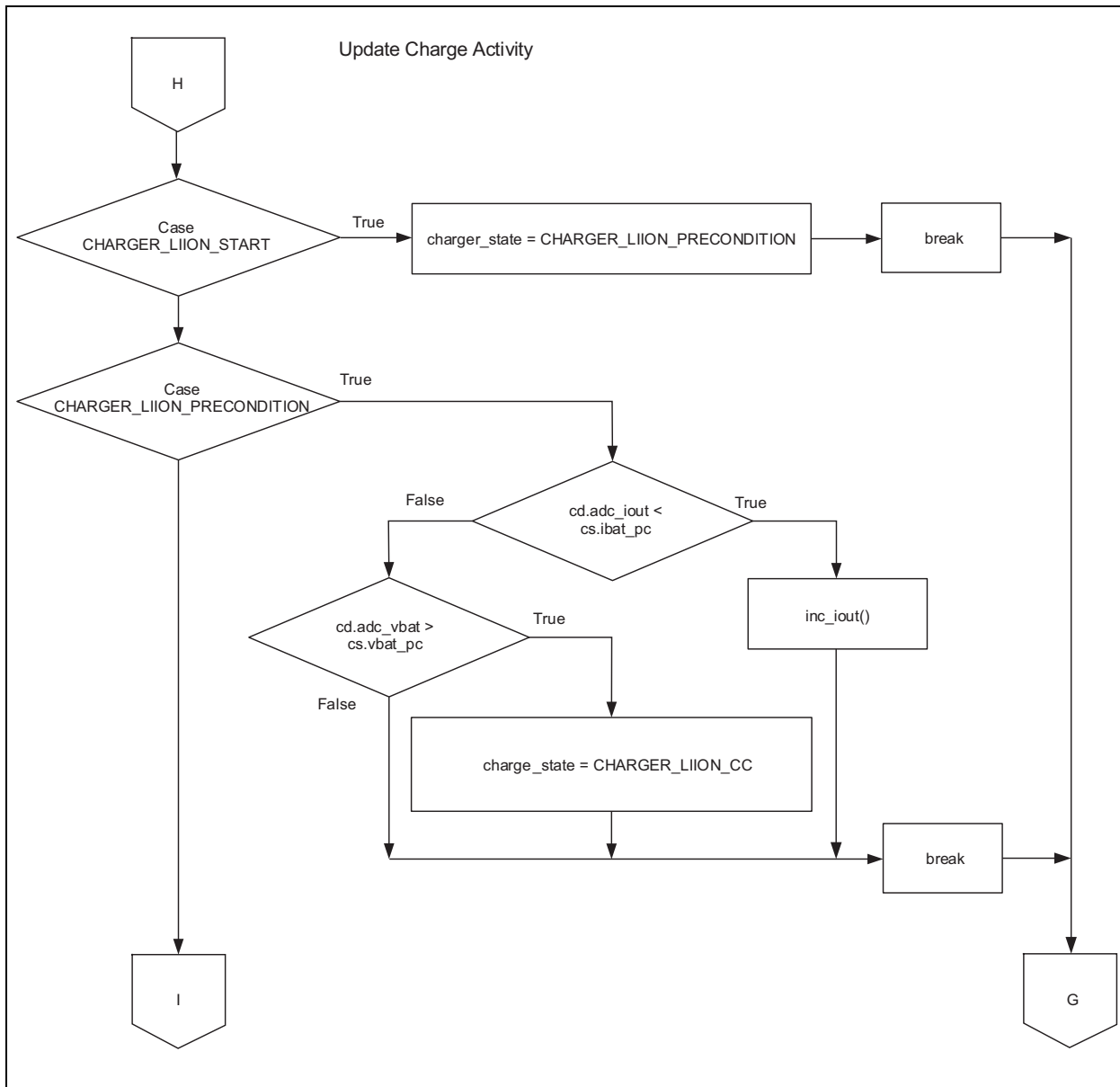

FIGURE C-2: Block Diagram of Li-Ion Profile Initialization.

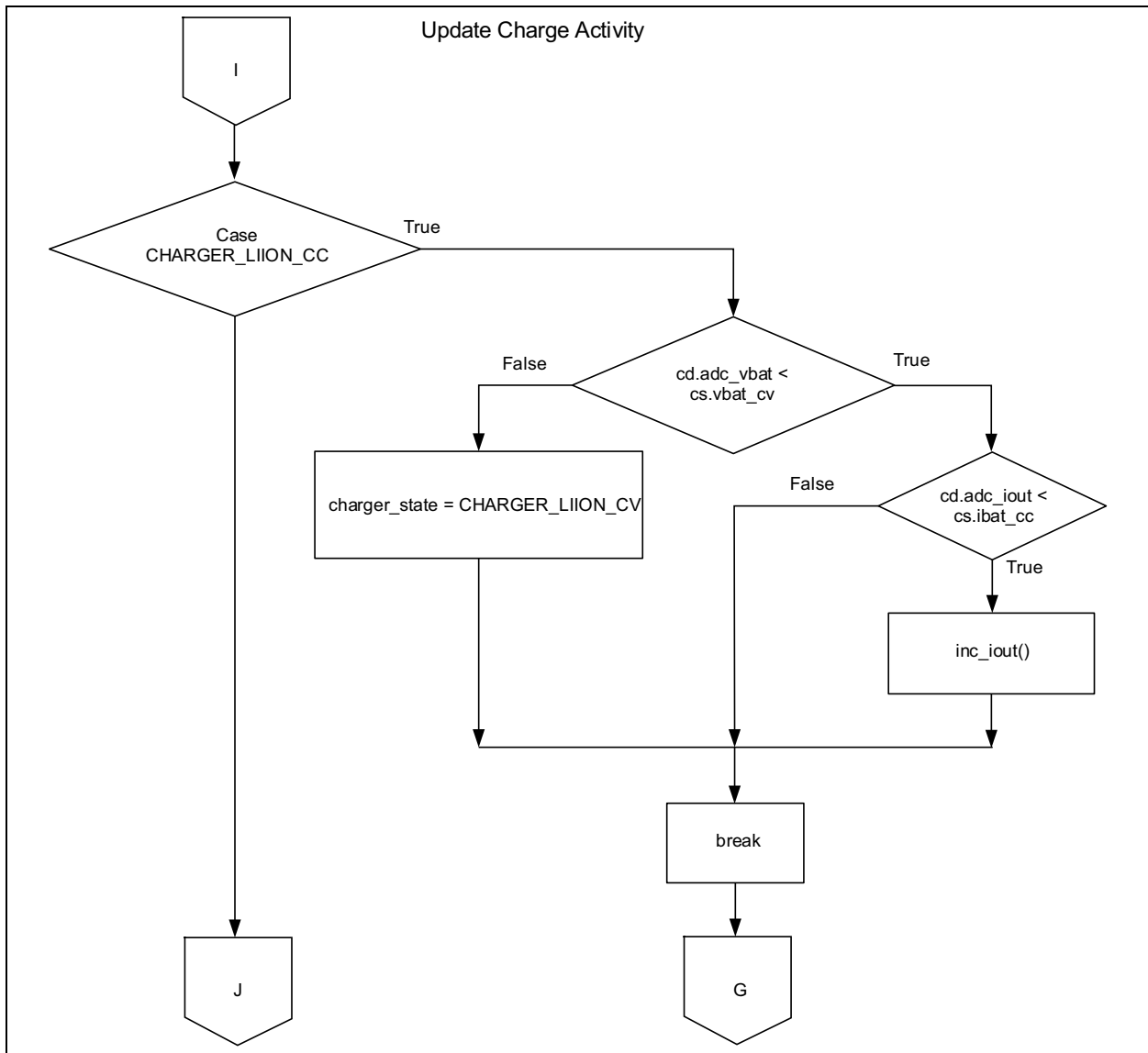

FIGURE C-3: Block Diagram of Transition to Li-Ion Constant-Current Charging Mode.

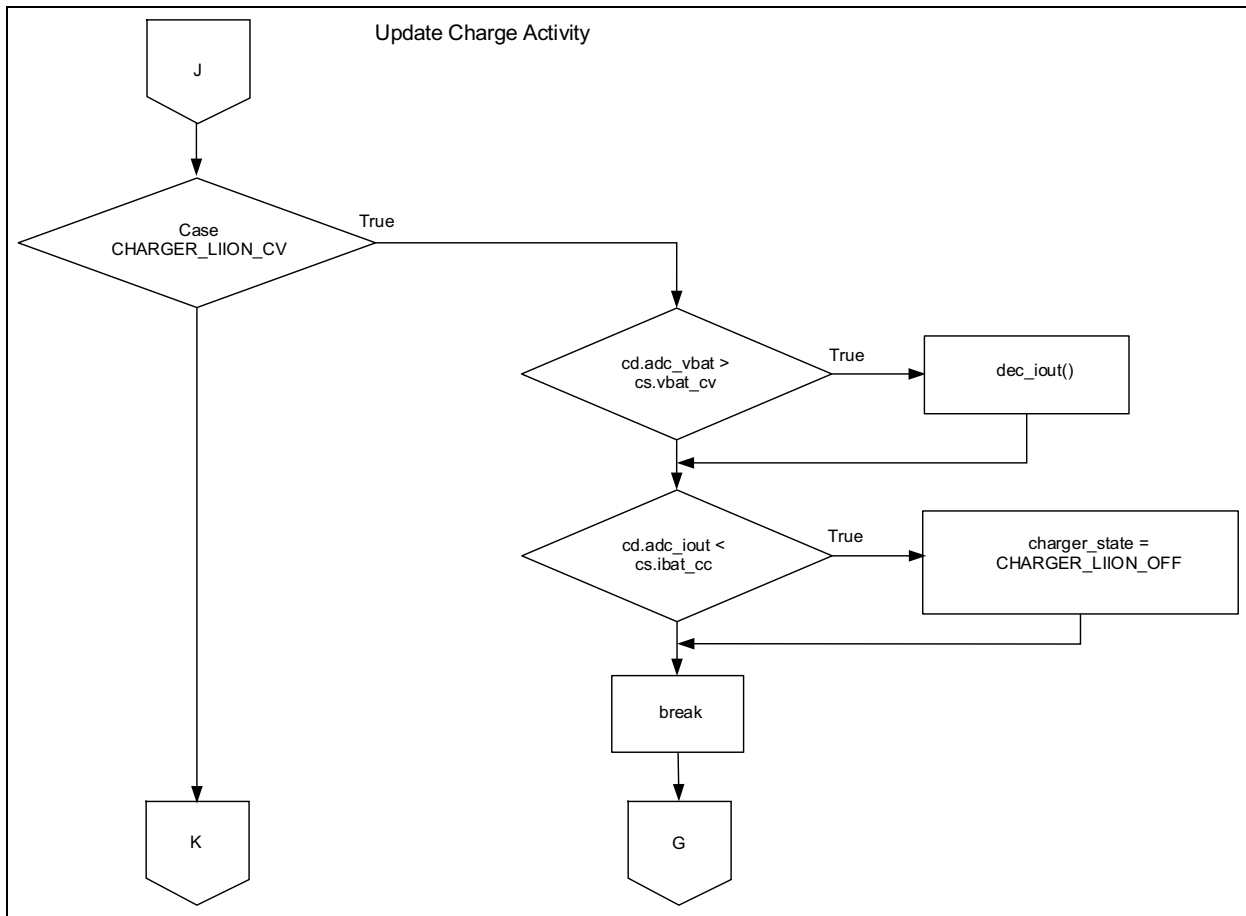

FIGURE C-4: Block Diagram of Li-Ion Profile Termination.

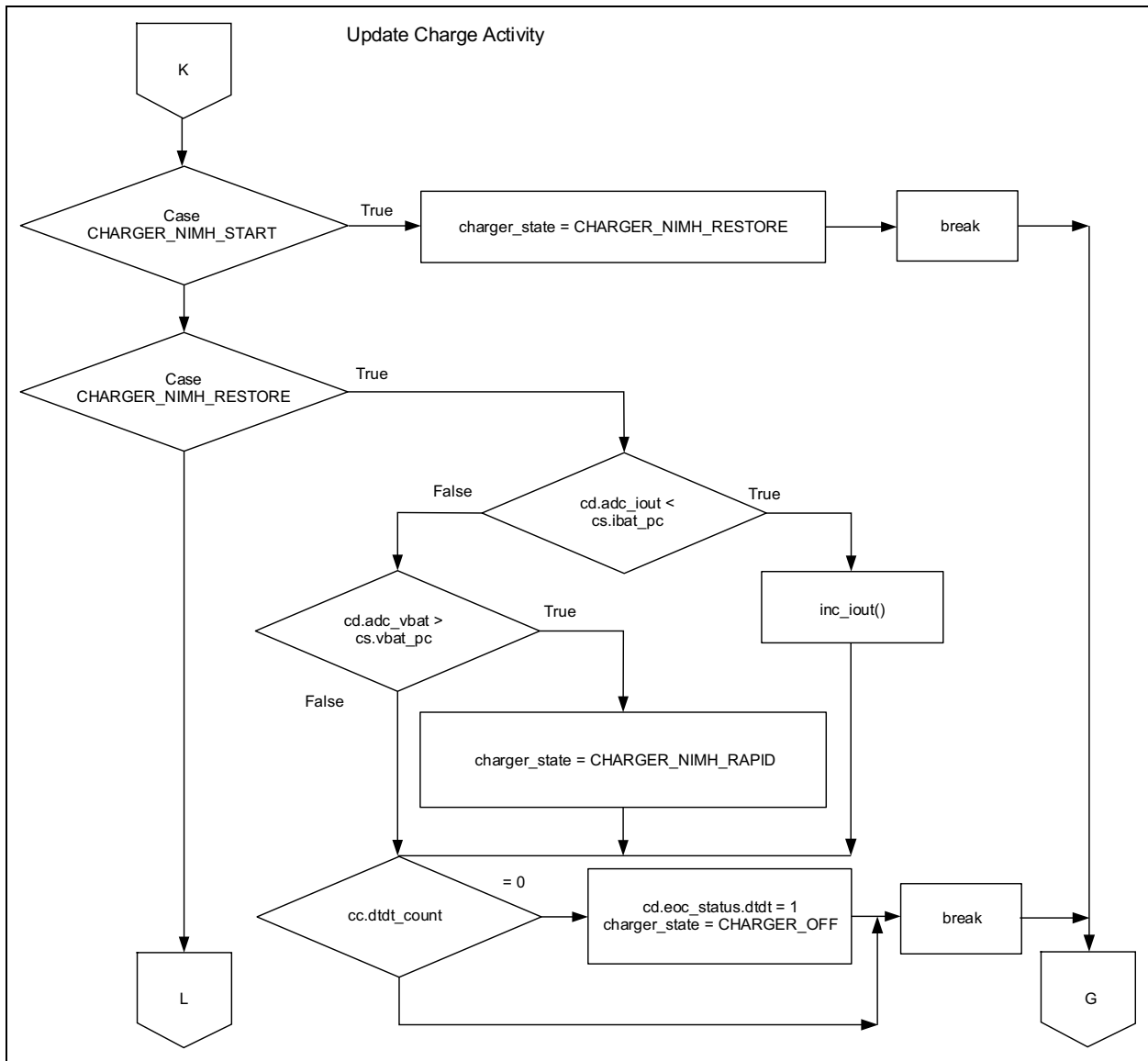

FIGURE C-5: Block Diagram of NiMH Profile Initialization and Transition to Rapid Charge Mode.

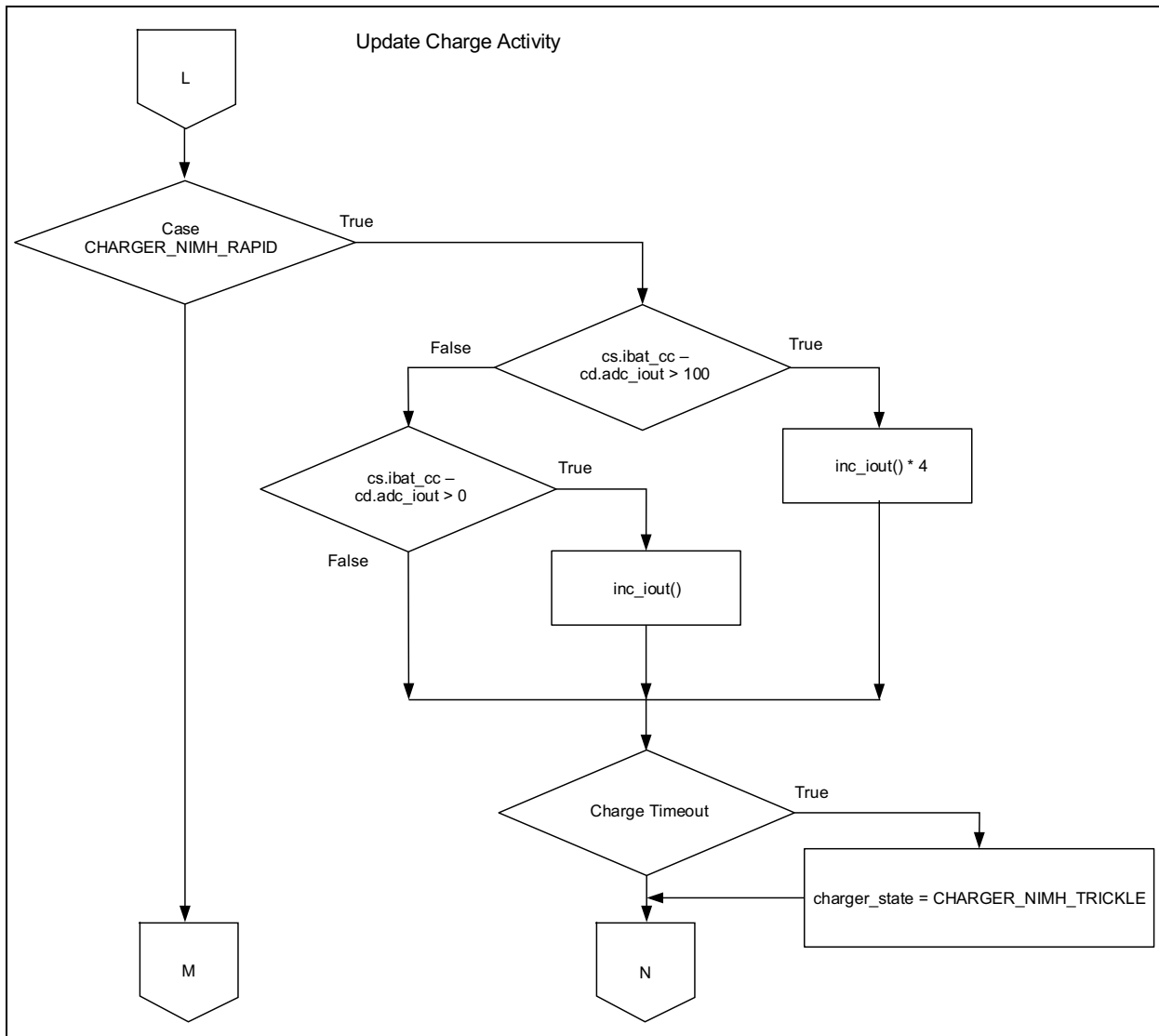

FIGURE C-6: Block Diagram of NiMH Profile Transition to Trickle Charge Mode.

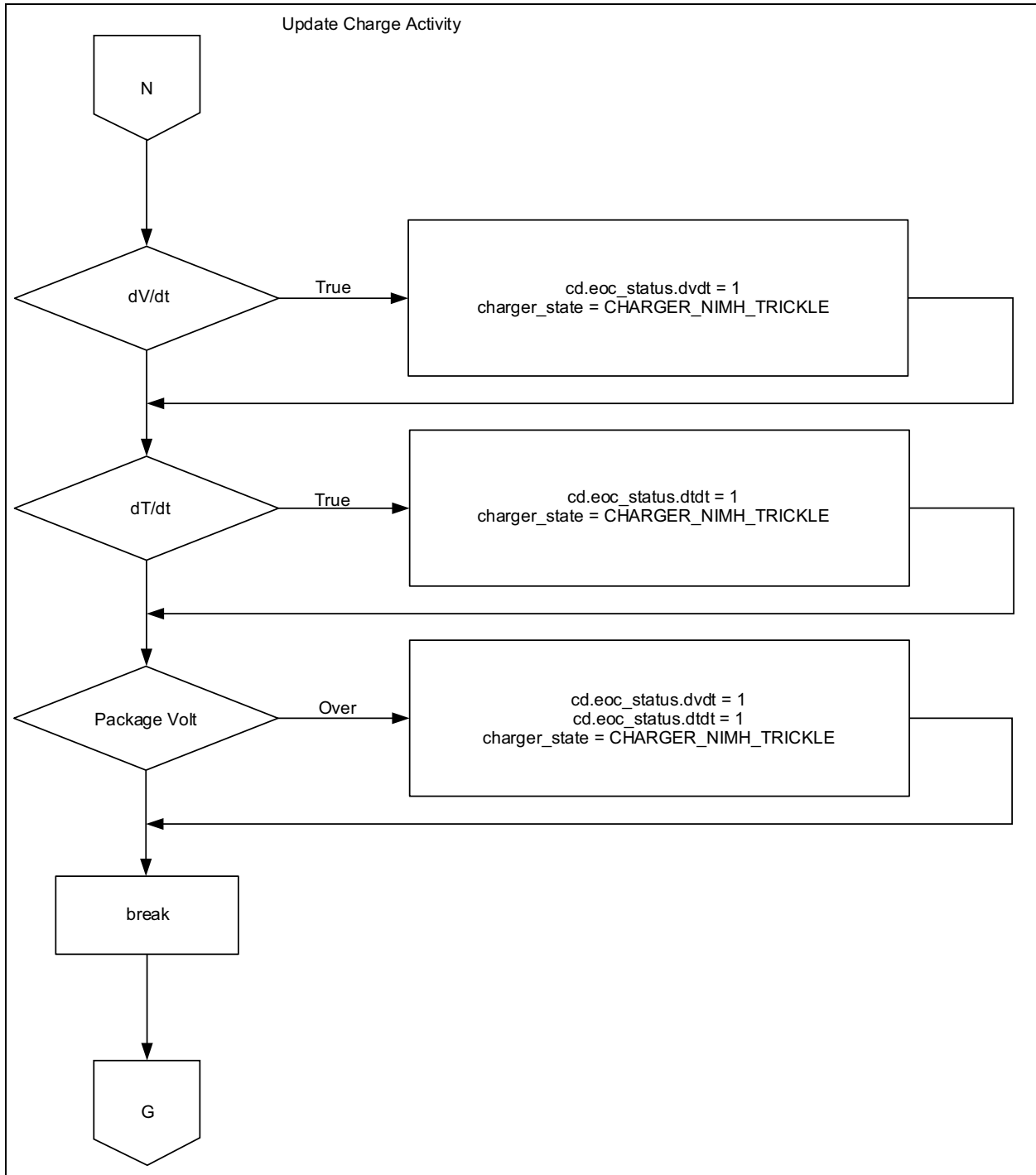

FIGURE C-7: Block Diagram of Voltage and Temperature Sense Termination Logic for NiMH Profile.

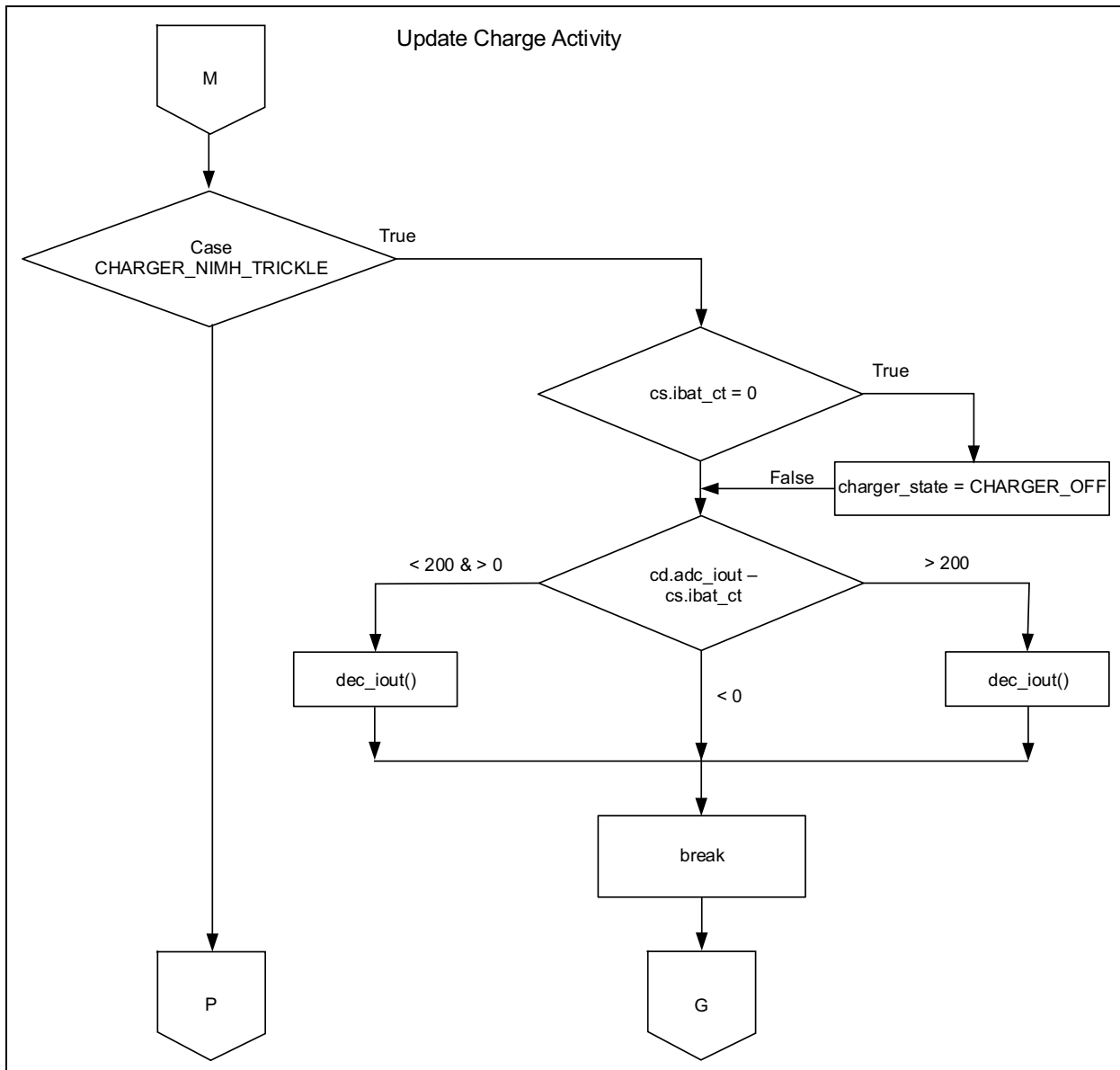

FIGURE C-8: Block Diagram of NiMH Profile Charge Termination.

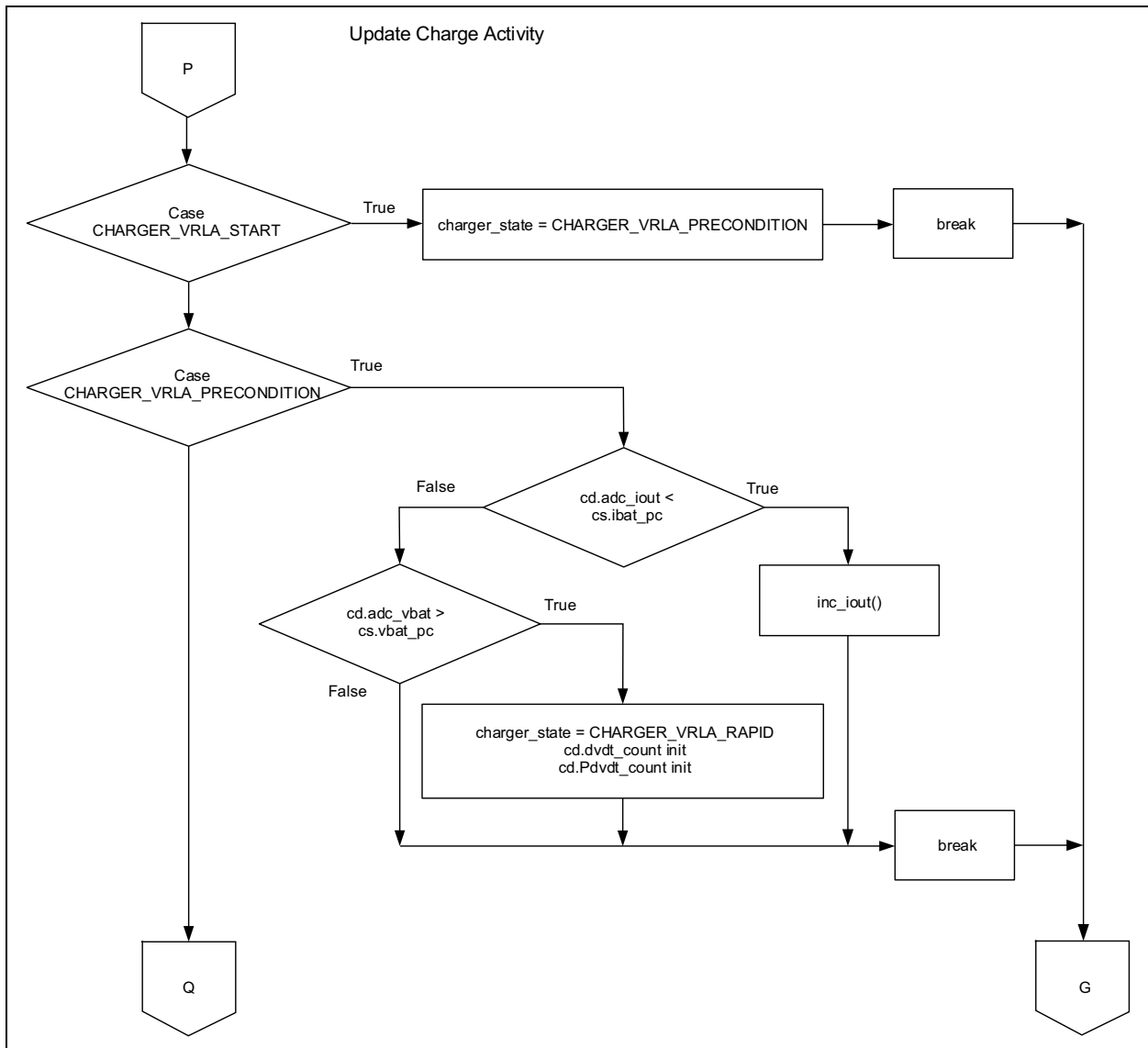

FIGURE C-9: Block Diagram of VRLA Profile Initialization and Transition to Rapid Charge Mode.

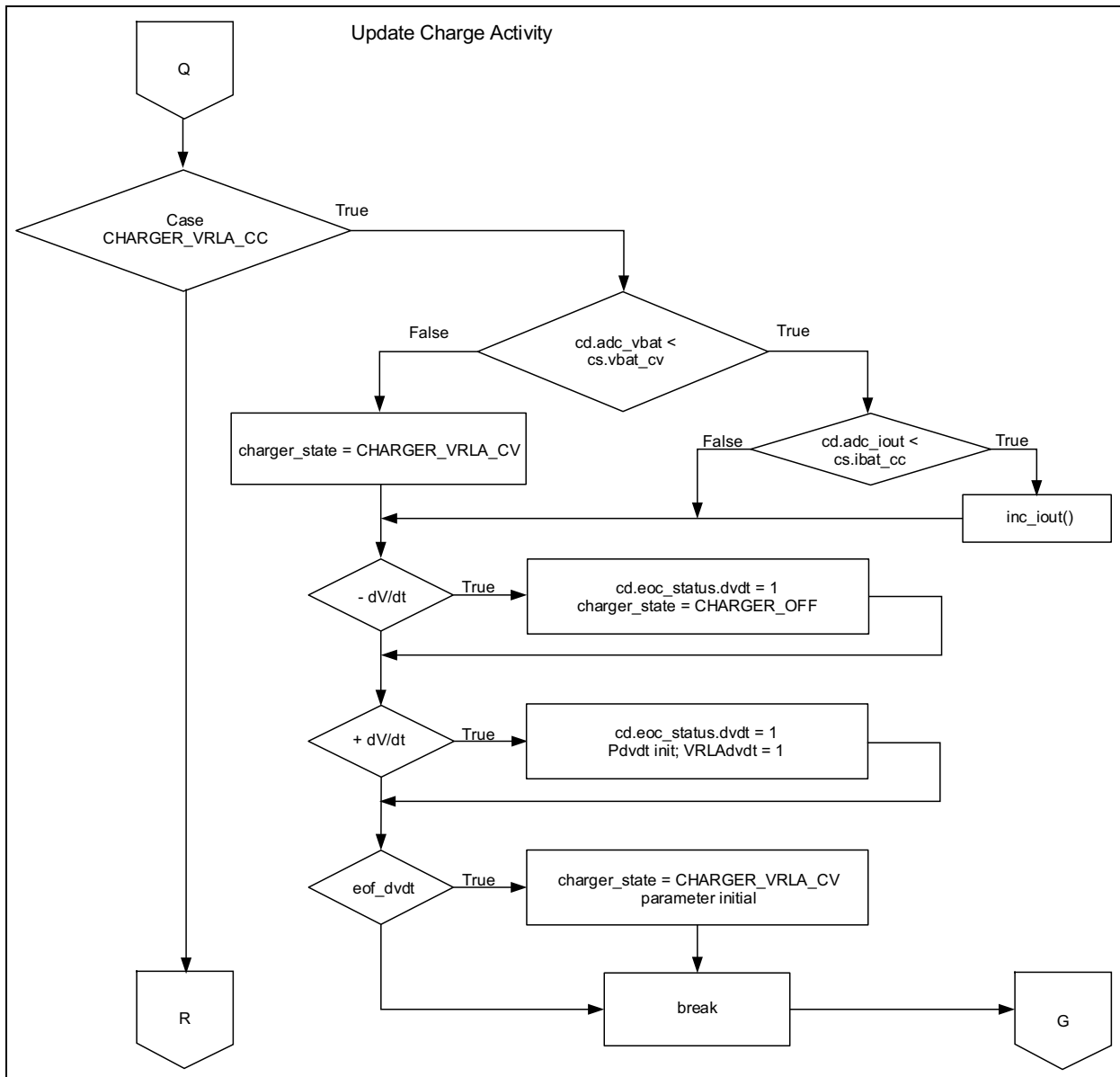

FIGURE C-10: Block Diagram of Transition to Constant-Voltage Mode.

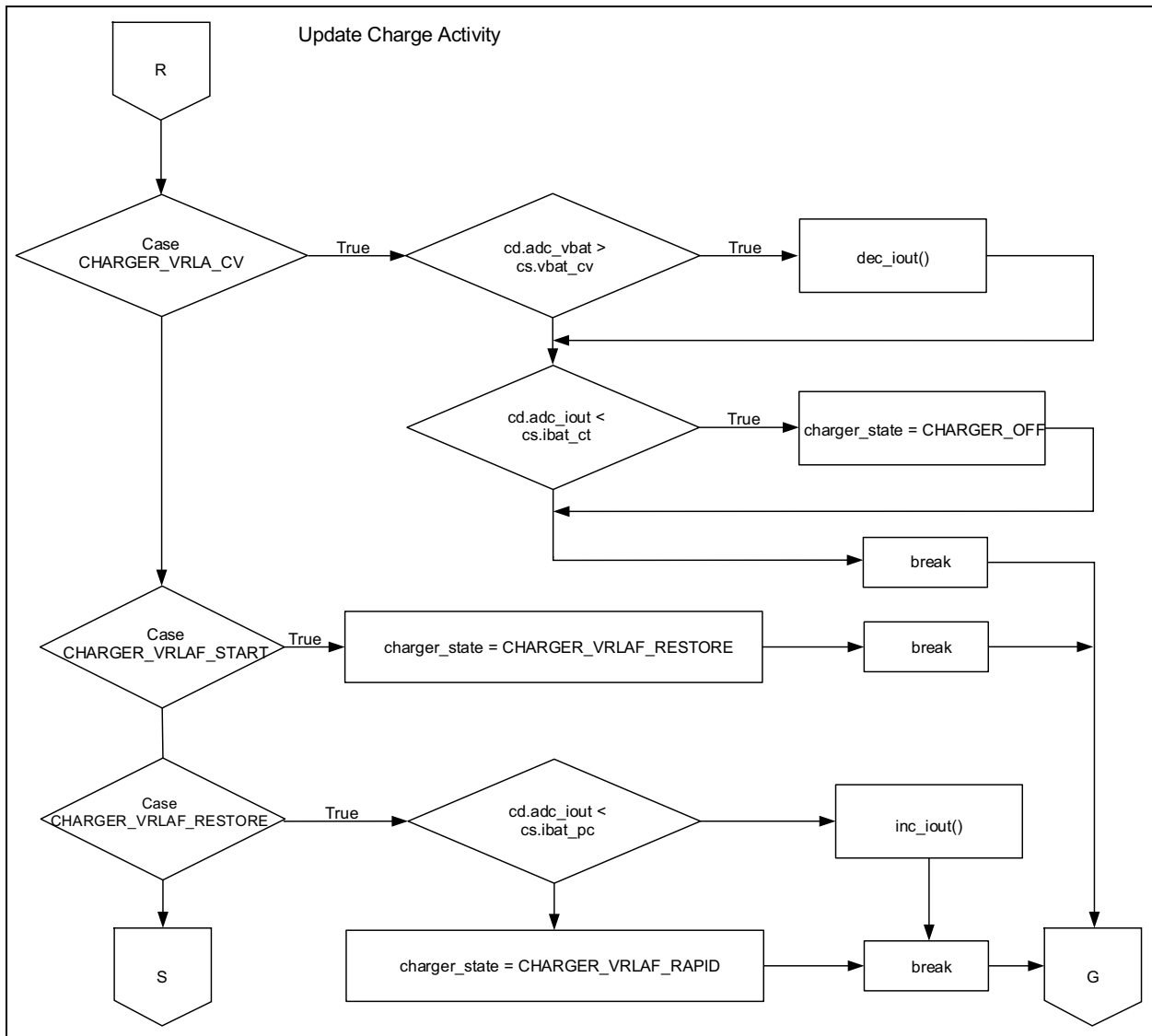

FIGURE C-11: Block Diagram of VRLA CCCP Charge Termination and VRLA Fast Profile Initialization.

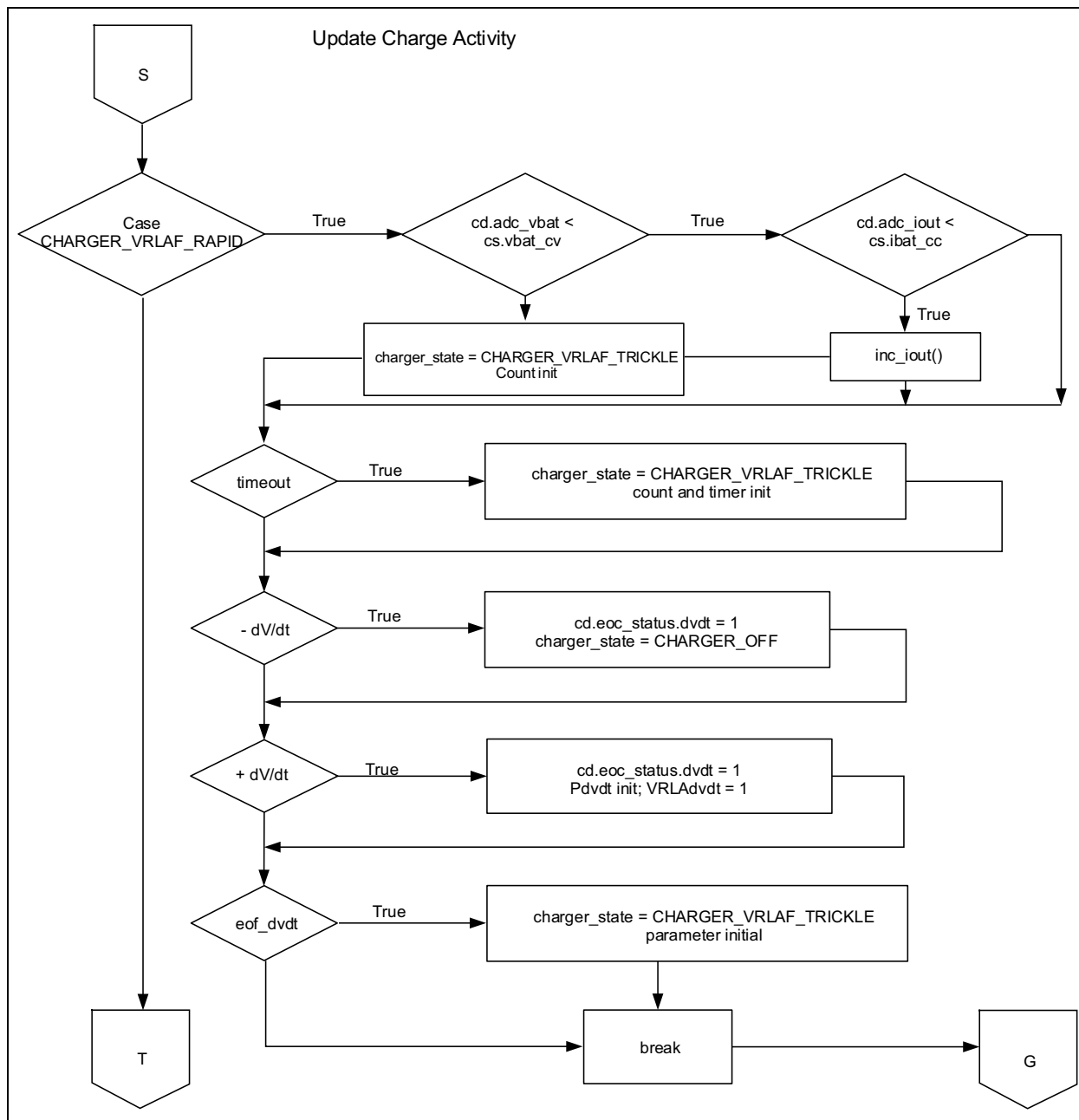

FIGURE C-12: Block Diagram of VRLA Fast Charge Profile Logic.

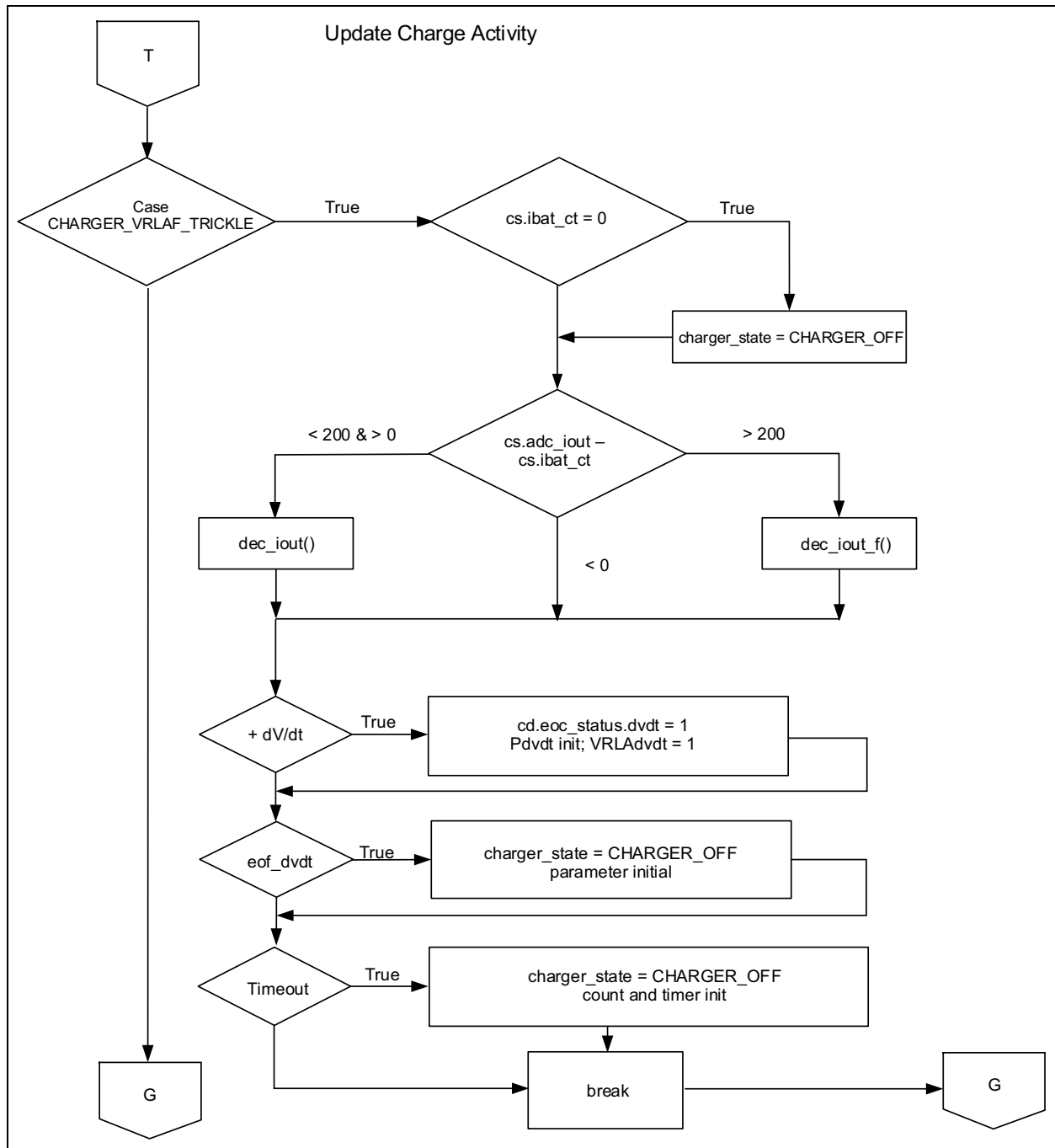

FIGURE C-13: Block Diagram of VRLA Fast Trickle Charge Mode and Profile Termination.

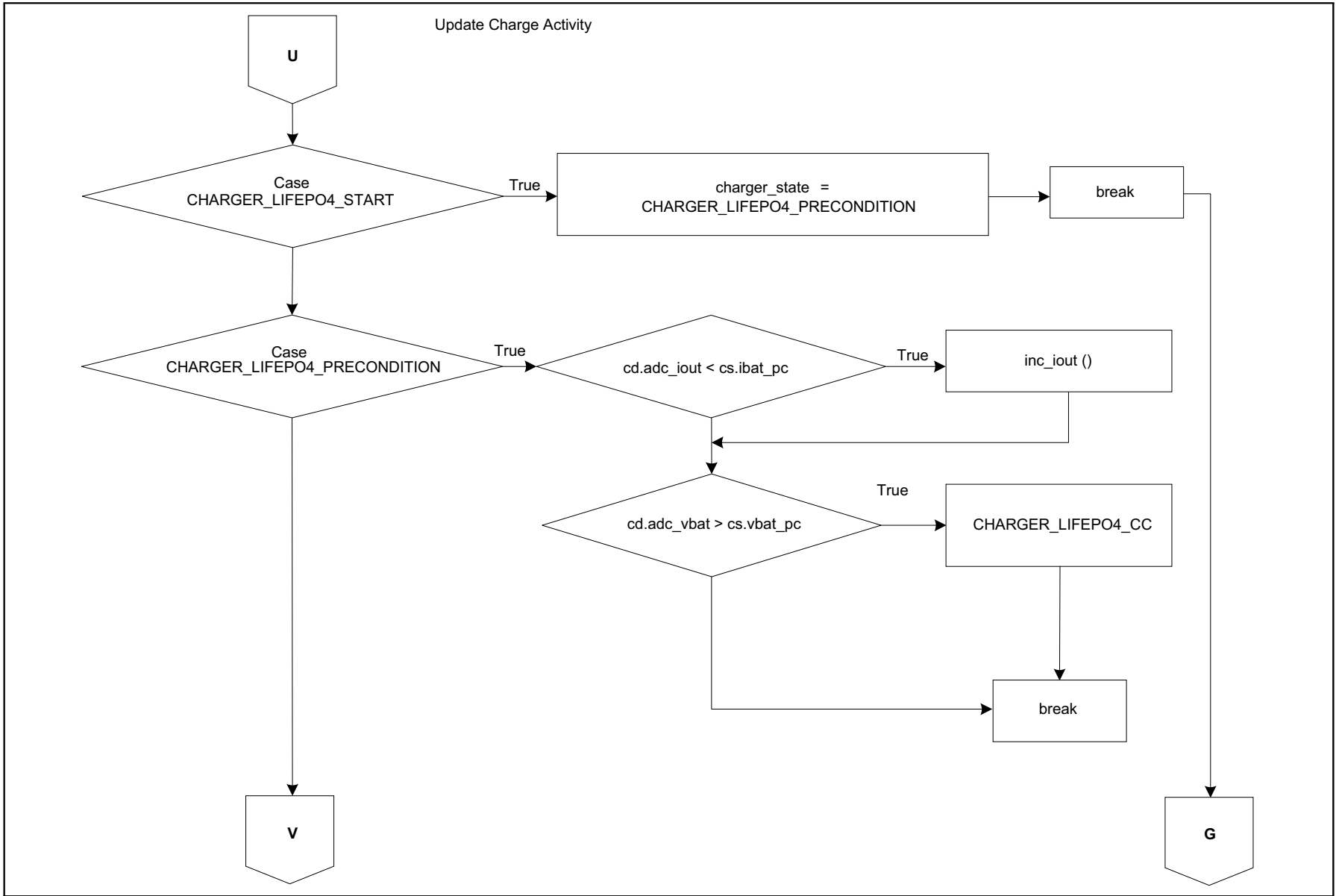

FIGURE C-14: Block Diagram of LiFEPO4 Profile Initialization.

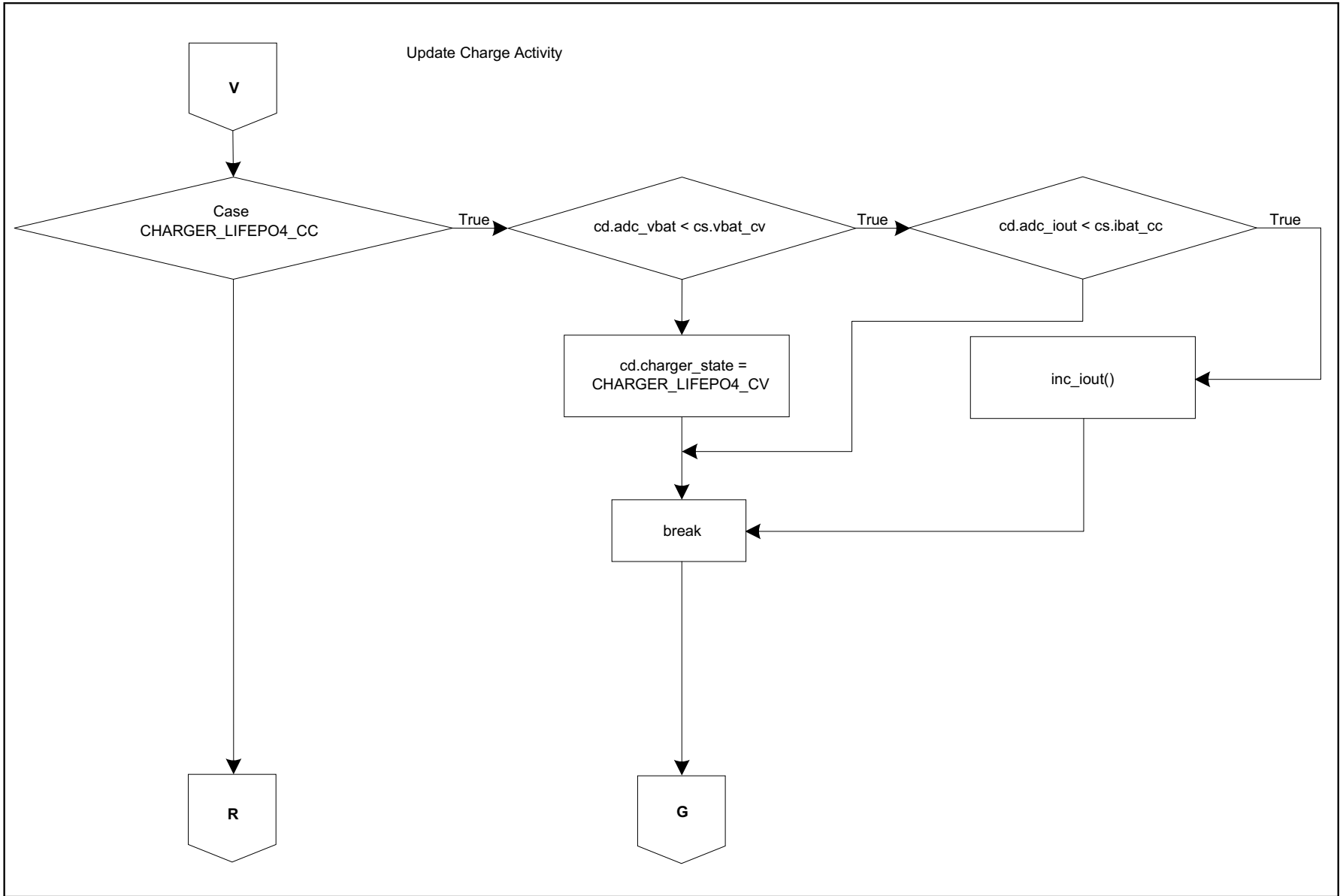

FIGURE C-15: Block Diagram of Transition to LiFEPO4 Constant-Current Charging Mode.

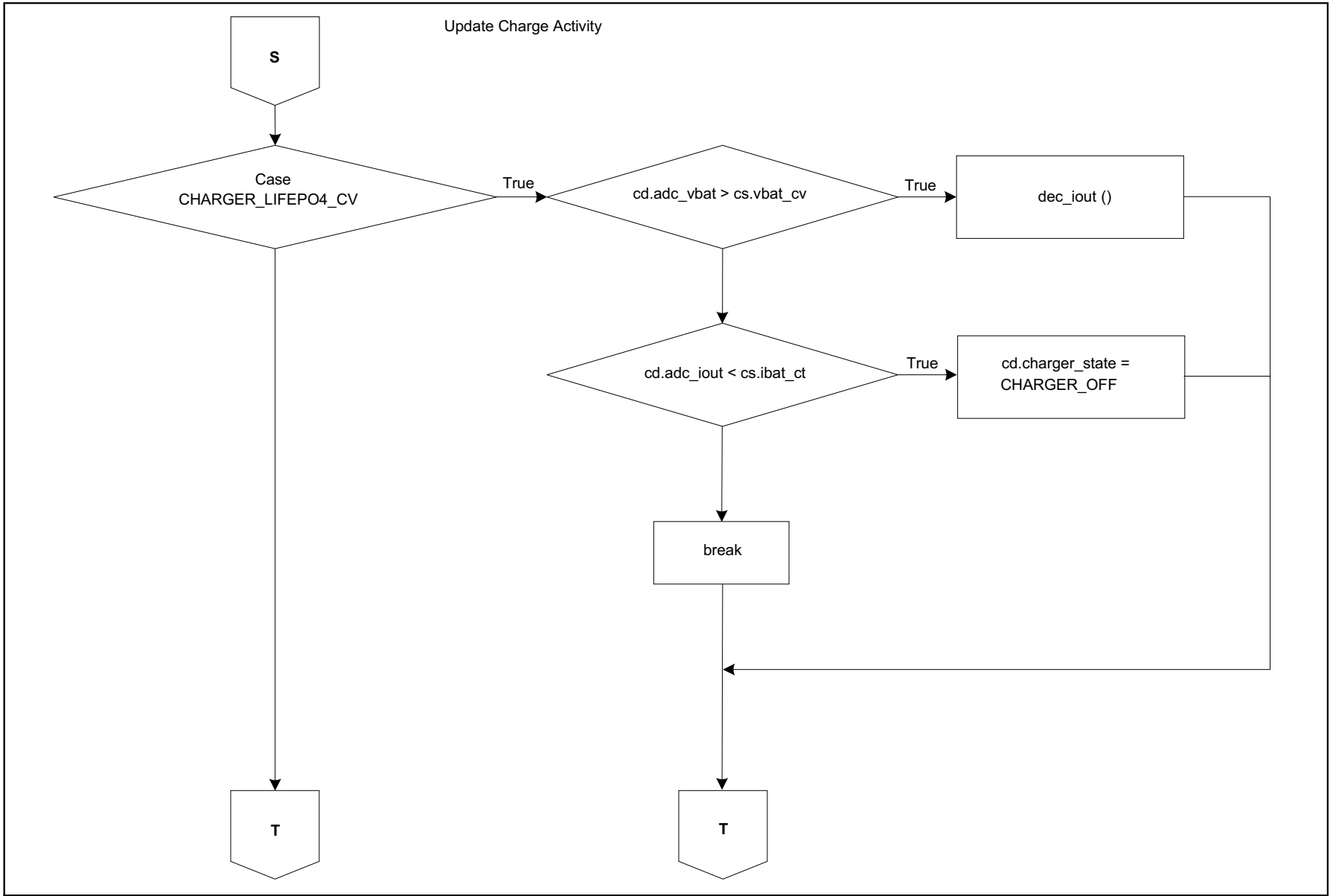

FIGURE C-16: Block Diagram of LiFEPO4 Profile Termination.



MICROCHIP

Worldwide Sales and Service

AMERICAS

Corporate Office
2355 West Chandler Blvd.
Chandler, AZ 85224-6199
Tel: 480-792-7200
Fax: 480-792-7277
Technical Support:
<http://www.microchip.com/support>
Web Address:
www.microchip.com

Atlanta
Duluth, GA
Tel: 678-957-9614
Fax: 678-957-1455

Austin, TX
Tel: 512-257-3370

Boston
Westborough, MA
Tel: 774-760-0087
Fax: 774-760-0088

Chicago
Itasca, IL
Tel: 630-285-0071
Fax: 630-285-0075

Dallas
Addison, TX
Tel: 972-818-7423
Fax: 972-818-2924

Detroit
Novi, MI
Tel: 248-848-4000

Houston, TX
Tel: 281-894-5983

Indianapolis
Noblesville, IN
Tel: 317-773-8323
Fax: 317-773-5453
Tel: 317-536-2380

Los Angeles
Mission Viejo, CA
Tel: 949-462-9523
Fax: 949-462-9608
Tel: 951-273-7800

Raleigh, NC
Tel: 919-844-7510

New York, NY
Tel: 631-435-6000

San Jose, CA
Tel: 408-735-9110
Tel: 408-436-4270

Canada - Toronto
Tel: 905-695-1980
Fax: 905-695-2078

ASIA/PACIFIC

Asia Pacific Office
Suites 3707-14, 37th Floor
Tower 6, The Gateway
Harbour City, Kowloon

Hong Kong
Tel: 852-2943-5100
Fax: 852-2401-3431

Australia - Sydney
Tel: 61-2-9868-6733
Fax: 61-2-9868-6755

China - Beijing
Tel: 86-10-8569-7000
Fax: 86-10-8528-2104

China - Chengdu
Tel: 86-28-8665-5511
Fax: 86-28-8665-7889

China - Chongqing
Tel: 86-23-8980-9588
Fax: 86-23-8980-9500

China - Dongguan
Tel: 86-769-8702-9880

China - Guangzhou
Tel: 86-20-8755-8029

China - Hangzhou
Tel: 86-571-8792-8115
Fax: 86-571-8792-8116

China - Hong Kong SAR
Tel: 852-2943-5100
Fax: 852-2401-3431

China - Nanjing
Tel: 86-25-8473-2460
Fax: 86-25-8473-2470

China - Qingdao
Tel: 86-532-8502-7355
Fax: 86-532-8502-7205

China - Shanghai
Tel: 86-21-3326-8000
Fax: 86-21-3326-8021

China - Shenyang
Tel: 86-24-2334-2829
Fax: 86-24-2334-2393

China - Shenzhen
Tel: 86-755-8864-2200
Fax: 86-755-8203-1760

China - Wuhan
Tel: 86-27-5980-5300
Fax: 86-27-5980-5118

China - Xian
Tel: 86-29-8833-7252
Fax: 86-29-8833-7256

ASIA/PACIFIC

China - Xiamen
Tel: 86-592-2388138
Fax: 86-592-2388130

China - Zhuhai
Tel: 86-756-3210040
Fax: 86-756-3210049

India - Bangalore
Tel: 91-80-3090-4444
Fax: 91-80-3090-4123

India - New Delhi
Tel: 91-11-4160-8631
Fax: 91-11-4160-8632

India - Pune
Tel: 91-20-3019-1500

Japan - Osaka
Tel: 81-6-6152-7160
Fax: 81-6-6152-9310

Japan - Tokyo
Tel: 81-3-6880-3770
Fax: 81-3-6880-3771

Korea - Daegu
Tel: 82-53-744-4301
Fax: 82-53-744-4302

Korea - Seoul
Tel: 82-2-554-7200
Fax: 82-2-558-5932 or
82-2-558-5934

Malaysia - Kuala Lumpur
Tel: 60-3-6201-9857
Fax: 60-3-6201-9859

Malaysia - Penang
Tel: 60-4-227-8870
Fax: 60-4-227-4068

Philippines - Manila
Tel: 63-2-634-9065
Fax: 63-2-634-9069

Singapore
Tel: 65-6334-8870
Fax: 65-6334-8850

Taiwan - Hsin Chu
Tel: 886-3-5778-366
Fax: 886-3-5770-955

Taiwan - Kaohsiung
Tel: 886-7-213-7830

Taiwan - Taipei
Tel: 886-2-2508-8600
Fax: 886-2-2508-0102

Thailand - Bangkok
Tel: 66-2-694-1351
Fax: 66-2-694-1350

EUROPE

Austria - Wels
Tel: 43-7242-2244-39
Fax: 43-7242-2244-393

Denmark - Copenhagen
Tel: 45-4450-2828
Fax: 45-4485-2829

Finland - Espoo
Tel: 358-9-4520-820

France - Paris
Tel: 33-1-69-53-63-20
Fax: 33-1-69-30-90-79

France - Saint Cloud
Tel: 33-1-30-60-70-00

Germany - Garching
Tel: 49-8931-9700

Germany - Haan
Tel: 49-2129-3766400

Germany - Heilbronn
Tel: 49-7131-67-3636

Germany - Karlsruhe
Tel: 49-721-625370

Germany - Munich
Tel: 49-89-627-144-0
Fax: 49-89-627-144-44

Germany - Rosenheim
Tel: 49-8031-354-560

Israel - Ra'anana
Tel: 972-9-744-7705

Italy - Milan
Tel: 39-0331-742611
Fax: 39-0331-466781

Italy - Padova
Tel: 39-049-7625286

Netherlands - Drunen
Tel: 31-416-690399
Fax: 31-416-690340

Norway - Trondheim
Tel: 47-7289-7561

Poland - Warsaw
Tel: 48-22-3325737

Romania - Bucharest
Tel: 40-21-407-87-50

Spain - Madrid
Tel: 34-91-708-08-90
Fax: 34-91-708-08-91

Sweden - Gothenberg
Tel: 46-31-704-60-40

Sweden - Stockholm
Tel: 46-8-5090-4654

UK - Wokingham
Tel: 44-118-921-5800
Fax: 44-118-921-5820