

Microchip**Filter specification****TFS718A****1/5****Measurement condition**

Ambient temperature T_A :	23	°C
Input power level:	0	dBm
Terminating impedance:		
Input:	50	Ω
Output:	50	Ω

Characteristics

Remark:

The maximum attenuation in the pass band is defined as the insertion loss a_e . The nominal frequency f_N is fixed at 718 MHz without any tolerance or limit. The values of absolute attenuation a_{abs} are guaranteed over the whole operating temperature range. The frequency shift of the filter within the operating temperature range is included in the production tolerance scheme.

D a t a		typ. value		tolerance / limit	
Insertion loss		a_e	2.4 dB	max.	3.5 dB
Nominal frequency		f_N	-		718.0 MHz
Passband		PB	-	$f_N \pm$	16.0 MHz
Absolute attenuation		a_{abs}			
10 MHz ...	618 MHz		51 dB	min.	40 dB
818 MHz ...	1200 MHz		46 dB	min.	38 dB
1200 MHz ...	2000 MHz		39 dB	min.	30 dB
Return loss within PB		RL	18 dB	min.	12 dB
Input power level			-	max.	10 dBm
Operating temperature range		OTR			-40 °C ... +85 °C
Storage temperature range					-55 °C ... +125 °C
Temperature coefficient of frequency		TC_f *)	-75 ppm/K		

$$*) \Delta f = TC_f (T - T_A) f_N$$

Generated:**Checked / Approved:**

Microchip Frequency Technology GmbH
Potsdamer Straße 18
D 14 513 TELTOW / Germany
Tel: (+49) 3328 4784-0 / Fax: (+49) 3328 4784-30

Microchip Frequency Technology GmbH reserves the right to make changes to the product(s) and/or information contained herein without notice. No liability is assumed as a result of their use or application. No rights under any patent accompany the sale of any such product(s) or information.

Filter characteristic

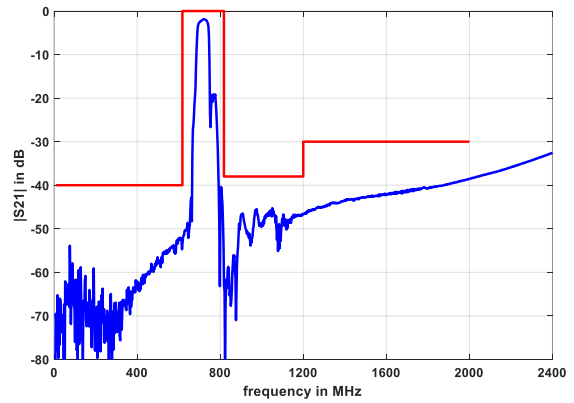
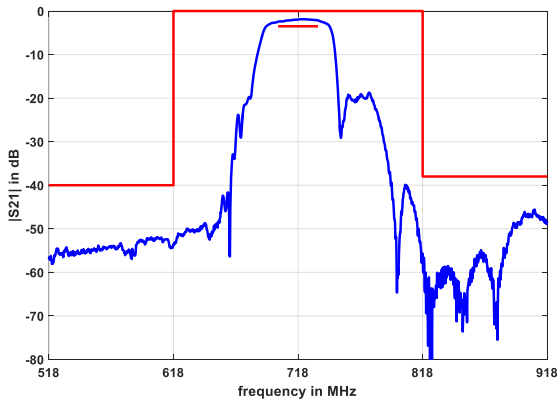

Construction and pin connection

(All dimensions in mm)

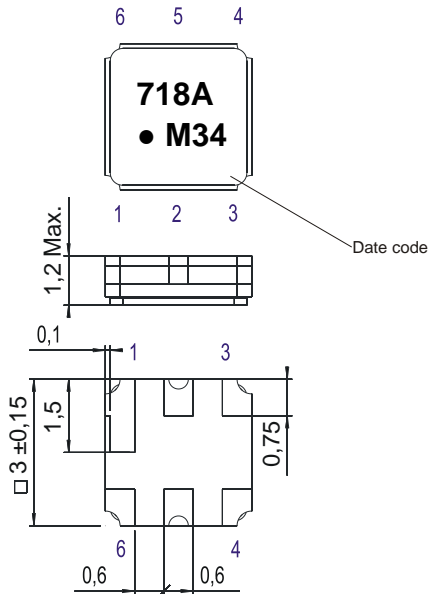

1	Ground
2	Input
3	Ground
4	Ground
5	Output
6	Ground

Date code: Year + week
 M 2020
 N 2021
 P 2022
 ...

50 Ω Test circuit

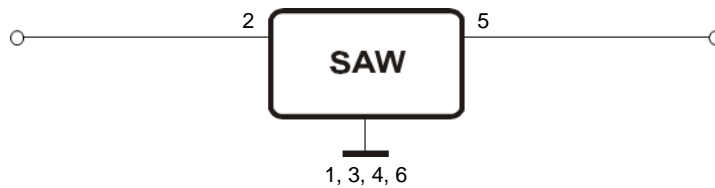

Microchip Frequency Technology GmbH
 Potsdamer Straße 18
 D 14 513 TELTOW / Germany
 Tel: (+49) 3328 4784-0 / Fax: (+49) 3328 4784-30

Microchip Frequency Technology GmbH reserves the right to make changes to the product(s) and/or information contained herein without notice. No liability is assumed as a result of their use or application. No rights under any patent accompany the sale of any such product(s) or information.

Stability characteristics, reliability

After the following tests the filter shall meet the whole specification:

1. Shock: 500 g, 1 ms, half sine wave, 3 shocks each plane;
DIN IEC 60068 T2 - 27
2. Vibration: 10 Hz to 2000 Hz, 0.35 mm or 5 g respectively, 1 octave per min, 10 cycles per plane, 3 planes; DIN IEC 60068 T2 - 6
3. Change of temperature: -55 °C to 125 °C / 15 min. each / 100 cycles
DIN IEC 60068 part 2 – 14 Test N
4. Resistance to solder heat (reflow): reflow possible: three times max.;
for temperature conditions refer to the attached "Air reflow temperature conditions" on page 4;
5. SAW devices are Electrostatic Discharge (ESD) sensitive devices.

This filter is RoHS compliant (2011/65/EU+2015/863/EU)

Packing

Tape & Reel: IEC 286 – 3, with exception of value for N and minimum bending radius;
tape type II, embossed carrier tape with top cover tape on the upper side;

reel of empty components at start:	min. 300 mm
reel of empty components at start including leader:	min. 500 mm
trailer:	min. 300 mm

Tape (all dimensions in mm)

- W : 8.00 ±0.3
- Po : 4.00 ±0.1
- Do : 1.50 +0.1/-0
- E : 1.75 ±0.1
- F : 3.50 ±0.05
- G(min) : 0.75
- P2 : 2.00 ±0.05
- P1 : 4.00 ±0.1
- D1(min) : 1.50
- Ao : 3.25 ±0.1
- Bo : 3.25 ±0.1
- Ct : 5.30 ±0.1
- Ko : 1.50 ±0.1
- t : 0.25 ±0.05

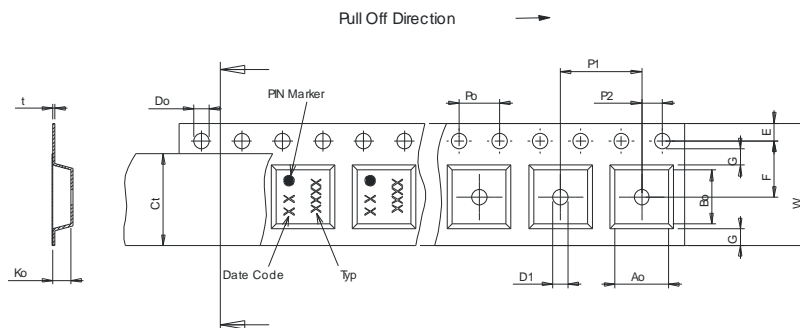

Reel (all dimensions in mm)

- A : 330 or 180
- W1 : 8.40 +1.5/-0
- W2(max) : 14.40
- N(min) : 60.00
- C : 13.0 ±0.2

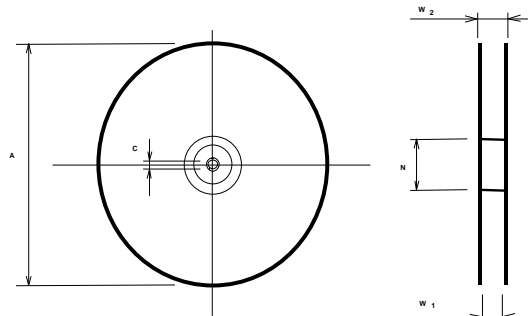

The minimum bending radius is 45 mm.

Microchip Frequency Technology GmbH
Potsdamer Straße 18
D 14 513 TELTOW / Germany
Tel: (+49) 3328 4784-0 / Fax: (+49) 3328 4784-30

Microchip Frequency Technology GmbH reserves the right to make changes to the product(s) and/or information contained herein without notice. No liability is assumed as a result of their use or application. No rights under any patent accompany the sale of any such product(s) or information.

Air reflow temperature conditions

Conditions	Exposure
Average ramp-up rate (30 °C to 217 °C)	less than 3 °C / second
> 100 °C	between 300 and 600 seconds
> 150 °C	between 240 and 500 seconds
> 217 °C	between 30 and 150 seconds
Peak temperature	max. 260 °C
Time within 5 °C of actual peak temperature	between 10 and 30 seconds
Cool-down rate (Peak to 50 °C)	less than 6 °C / second
Time from 30 °C to Peak temperature	no greater than 300 seconds

Chip-mount air reflow profile

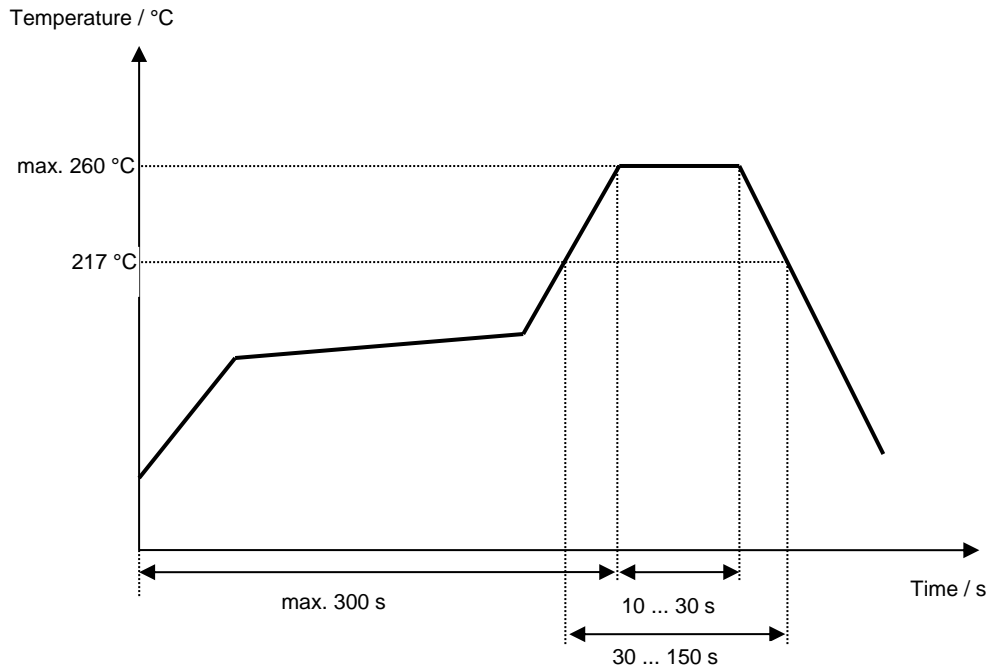

Microchip**Filter specification****TFS718A****5/5**

History

Version	Reason of Change	Name	Date
1.0	- generation of development specification	P. Jaster	07.01.2020
1.1	- changed from development spec to filter spec - added typical values - added filter characteristics	P. Jaster	19.08.2020