

Microchip**Filter specification****TFS 310C****1/5****Measurement condition**

Ambient temperature T_A :	23	°C
Input power level:	0	dBm
Terminating impedance: *		
Input:	235 Ω	-7.0 pF
Output:	235 Ω	-7.0 pF

Characteristics

Remark:

The reference level for the relative attenuation a_{rel} of the TFS 310C is the minimum of the pass band attenuation. This value is defined as the insertion loss a_e . The nominal frequency f_N is fixed at 310 MHz without any tolerance. The values of relative attenuation a_{rel} are guaranteed over the whole operating temperature range. The frequency shift of the filter within the operating temperature range is included in the production tolerance scheme.

D a t a		typ. value	tolerance / limit
Insertion loss (reference level)	a_e	8 dB	max. 10.5 dB
Nominal frequency	f_N		310.0 MHz
Passband	PB		$f_N \pm 15$ MHz
Pass band ripple		0.3 dB	max. 0.8 dB
Relative attenuation	a_{rel}		
f_N MHz ... $f_N \pm 15$ MHz		0.3 dB	max. 0.8 dB
$f_N - 260$ MHz ... $f_N - 110$ MHz		62 dB	min. 50 dB
$f_N + 110$ MHz ... $f_N + 245$ MHz		56 dB	min. 50 dB
$2 \times f_N \pm 65$ MHz		46 dB	min. 35 dB
$3 \times f_N \pm 100$ MHz		72 dB	min. 45 dB
Return loss within PB		- dB	min. 10 dB
Input power level ***			max. 25 dBm
Operating temperature range	OTR		- 40 °C ... + 85 °C
Storage temperature range			- 55 °C ... + 125 °C
Temperature coefficient of frequency	TC_f **	-94 ppm/K	

*) The terminating impedances depend on parasitics and q-values of matching elements and the board used, and are to be understood as reference values only. Should there be additional questions do not hesitate to ask for an application note or contact our design team.

***) $\Delta f = TC_f (T - T_A) f_N$

***) at $\leq +85$ °C, 30 dBm for ≤ 4000 hours at $\leq +85$ °C

Generated:

Checked / Approved:

Microchip Frequency Technology GmbH
Potsdamer Straße 18
D 14 513 TELTOW / Germany
Tel: (+49) 3328 4784-0 / Fax: (+49) 3328 4784-30

Microchip Frequency Technology GmbH reserves the right to make changes to the product(s) and/or information contained herein without notice. No liability is assumed as a result of their use or application. No rights under any patent accompany the sale of any such product(s) or information.

Filter characteristic

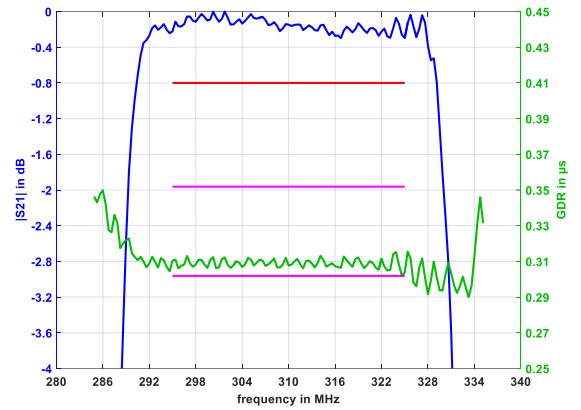
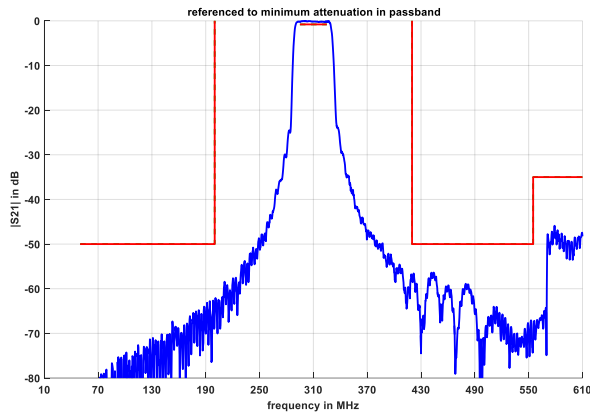

Construction and pin connection

(All dimensions in mm)

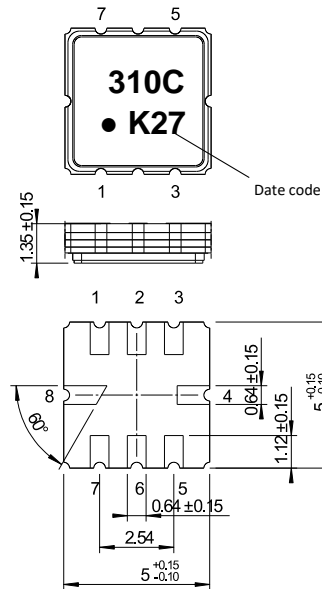

- 1 Ground
- 2 Ground
- 3 Output
- 4 Ground
- 5 Ground
- 6 Ground
- 7 Input
- 8 Ground

Date code: Year + week
 K 2018
 L 2019
 M 2020
 ...

Test circuit

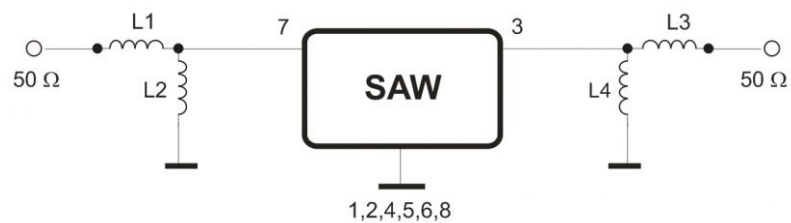

Microchip Frequency Technology GmbH
 Potsdamer Straße 18
 D 14 513 TELTOW / Germany
 Tel: (+49) 3328 4784-0 / Fax: (+49) 3328 4784-30

Microchip Frequency Technology GmbH reserves the right to make changes to the product(s) and/or information contained herein without notice. No liability is assumed as a result of their use or application. No rights under any patent accompany the sale of any such product(s) or information.

Stability characteristics, reliability

After the following tests the filter shall meet the whole specification:

1. Shock: 500 g, 1 ms, half sine wave, 3 shocks each plane;
DIN IEC 60068 T2 - 27
2. Vibration: 10 Hz to 2000 Hz, 0.35 mm or 5 g respectively, 1 octave per min, 10 cycles per plane, 3 planes; DIN IEC 60068 T2 - 6
3. Change of temperature: -55 °C to 125 °C / 15 min. each / 100 cycles
DIN IEC 60068 part 2 – 14 Test N
4. Resistance to solder heat (reflow): reflow possible: three times max.;
for temperature conditions refer to the attached "Air reflow temperature conditions" on page 4;
5. SAW devices are Electrostatic Discharge (ESD) sensitive devices.

This filter is RoHS compliant (2011/65/EU)

Packing

Tape & Reel: IEC 286 – 3, with exception of value for N and minimum bending radius;
tape type II, embossed carrier tape with top cover tape on the upper side;

reel of empty components at start:	min. 300 mm
reel of empty components at start including leader:	min. 500 mm
trailer:	min. 300 mm

Tape (all dimensions in mm)

- W : 12.00 +0.3/-0.1
- Po : 4.00 ±0.1
- Do : 1.50 ±0.10
- E : 1.75 ±0.1
- F : 5.50
- G(min) : 0.75
- P2 : 2.00 ±0.1
- P1 : 8.00
- D1(min) : 1.50
- Ao : 5.30 ±0.1
- Bo : 5.30 ±0.1
- Ct : 9.2 ±0.1
- Ko : 2.10 ±0.1
- t : 0.30 ±0.05

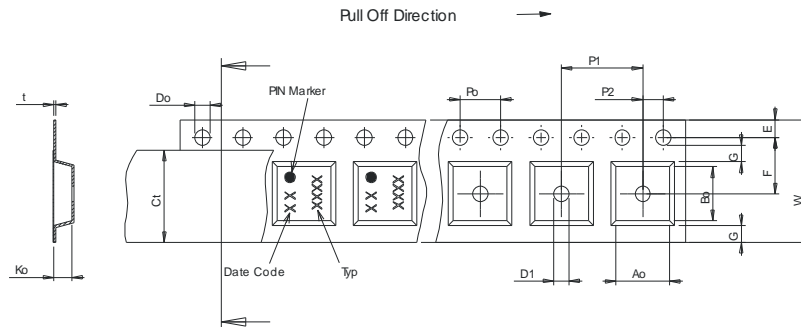

Reel (all dimensions in mm)

- A : 330 or 180
- W1 : 12.4 +2/-0
- W2(max) : 18.40
- N(min) : 50.00
- C : 13.0

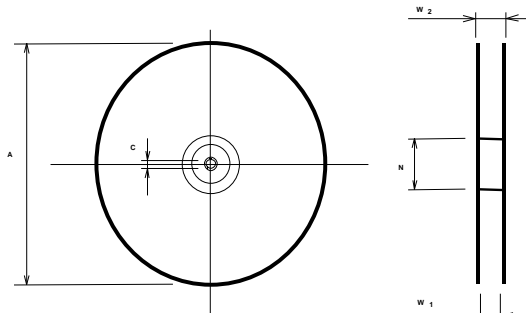

The minimum bending radius is 45 mm.

Microchip Frequency Technology GmbH
Potsdamer Straße 18
D 14 513 TELTOW / Germany
Tel: (+49) 3328 4784-0 / Fax: (+49) 3328 4784-30

Microchip Frequency Technology GmbH reserves the right to make changes to the product(s) and/or information contained herein without notice. No liability is assumed as a result of their use or application. No rights under any patent accompany the sale of any such product(s) or information.

Air reflow temperature conditions

Conditions	Exposure
Average ramp-up rate (30 °C to 217 °C)	less than 3 °C / second
> 100 °C	between 300 and 600 seconds
> 150 °C	between 240 and 500 seconds
> 217 °C	between 30 and 150 seconds
Peak temperature	max. 260 °C
Time within 5 °C of actual peak temperature	between 10 and 30 seconds
Cool-down rate (Peak to 50 °C)	less than 6 °C / second
Time from 30 °C to Peak temperature	no greater than 300 seconds

Chip-mount air reflow profile

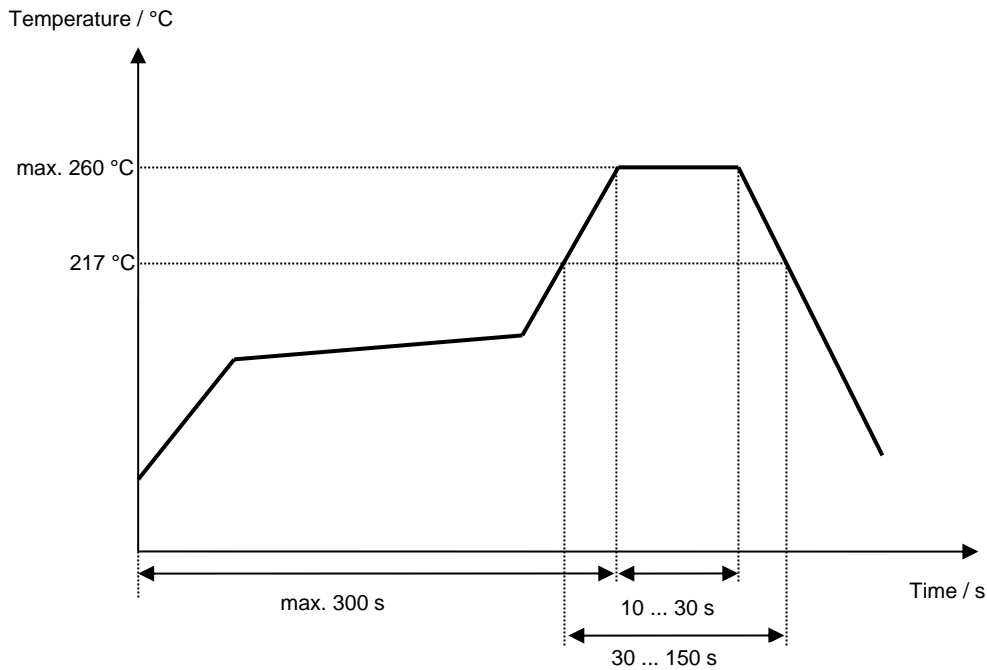

Microchip Frequency Technology GmbH
Potsdamer Straße 18
D 14 513 TELTOW / Germany
Tel: (+49) 3328 4784-0 / Fax: (+49) 3328 4784-30

Microchip Frequency Technology GmbH reserves the right to make changes to the product(s) and/or information contained herein without notice. No liability is assumed as a result of their use or application. No rights under any patent accompany the sale of any such product(s) or information.

Microchip**Filter specification****TFS 310C****5/5**

History

Version	Reason of Changes	Name	Date
1.0	- Generation of development specification	Jaffer	22.10.2018
1.1	- Generation of filter specification	Jaffer	07.02.2019

Microchip Frequency Technology GmbH
Potsdamer Straße 18
D 14 513 TELTOW / Germany
Tel: (+49) 3328 4784-0 / Fax: (+49) 3328 4784-30

Microchip Frequency Technology GmbH reserves the right to make changes to the product(s) and/or information contained herein without notice. No liability is assumed as a result of their use or application. No rights under any patent accompany the sale of any such product(s) or information.