

Microchip	Filter specification	TFS 522	1/5
------------------	-----------------------------	----------------	------------

Measurement condition

Ambient temperature (T ₀):	23	°C
Input power level:	0	dBm
Terminating impedance:		
Input:	50	Ω
Output:	50	Ω

Characteristics

Remark:

The maximum attenuation in the passband is defined as the insertion loss a_e. The nominal frequency f_N is fixed at 522 MHz without any tolerance or limit. The values of absolute attenuation a_{abs} are guaranteed for the whole operating temperature range. The frequency shift of the filter in the operating temperature range is included in the production tolerance scheme.

D a t a		typ. Value	tolerance / limit
Insertion loss within PB	a _e	2.2 dB	max. 3.0 dB
Nominal frequency	f _N	-	522 MHz
Passband	PB		f _N ± 12 MHz
Absolute attenuation	a _{abs}		
f _N ± 80 MHz ... f _N ± 149 MHz		48 dB	min. 33.5 dB
f _N + 149 MHz ... f _N + 300 MHz		49 dB	min. 45.0 dB
1 MHz ... 200 MHz		57 dB	min. 50.0 dB
200 MHz ... f _N - 149 MHz		60 dB	min. 55.0 dB
Group delay ripple within PB	p-p	10 ns	max. 0.2 μs
IIP3	*	-	min. 36 dBm
Input power level		-	max. 10 dBm
Operating temperature range	OTR	-	- 10 °C ... + 75 °C
Storage temperature range		-	- 40 °C ... + 85 °C
Temperature coefficient of frequency	TC _f **	-76 ppm/K	

*) f_{in1} = f_c - 14 MHz; f_{in2} = f_c - 14.4 MHz; P_{in} = 0 dBm; f_{measurement1} = f_c - 13.6 MHz; f_{measurement2} = f_c - 14.8 MHz. The centre frequency f_c is the arithmetic mean value of the upper and lower frequencies at the 3 dB filter attenuation level relative to the insertion loss a_e.

***) Δf_c [Hz] = TC_f [ppm/K] × (T[K] - T₀[K]) × f_{to} [MHz]

Generated: _____

Checked / Approved: _____

Microchip Frequency Technology GmbH
Potsdamer Straße 18
D 14 513 TELTOW / Germany
Tel: (+49) 3328 4784-0 / Fax: (+49) 3328 4784-30

Microchip Frequency Technology GmbH reserves the right to make changes to the product(s) and/or information contained herein without notice. No liability is assumed as a result of their use or application. No rights under any patent accompany the sale of any such product(s) or information.

Filter characteristic

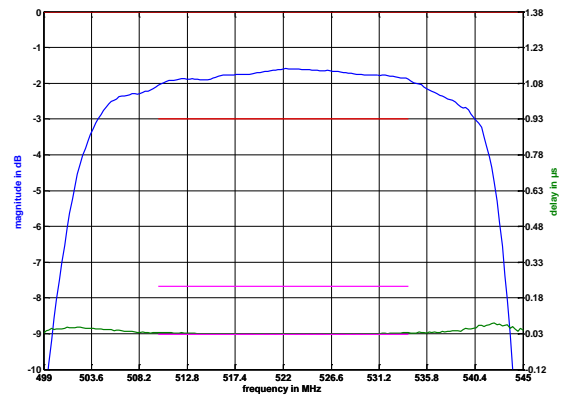
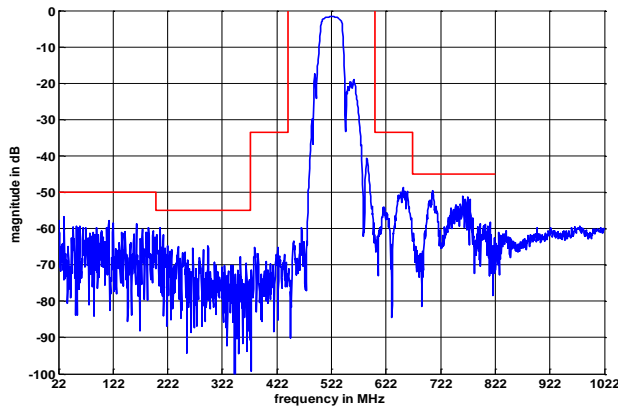

Construction and pin connection

(All dimensions in mm)

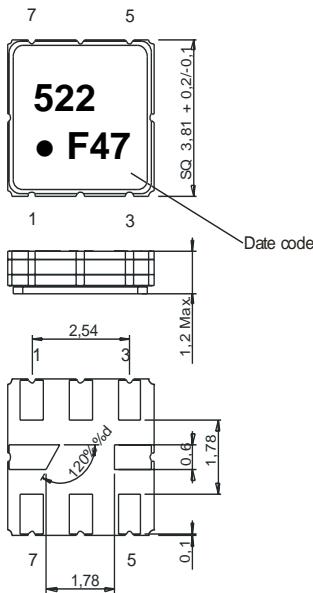

1	Ground
2	Input
3	Ground
4	Ground
5	Ground
6	Output
7	Ground
8	Ground

Date code: Year + week

F	2015
G	2016
H	2017
...	

50 Ω Test circuit

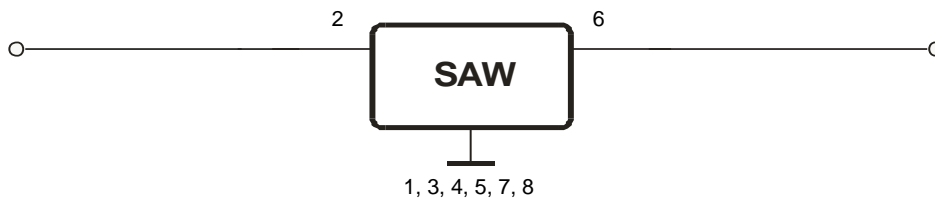

Microchip Frequency Technology GmbH
Potsdamer Straße 18
D 14 513 TELTOW / Germany
Tel: (+49) 3328 4784-0 / Fax: (+49) 3328 4784-30

Microchip Frequency Technology GmbH reserves the right to make changes to the product(s) and/or information contained herein without notice. No liability is assumed as a result of their use or application. No rights under any patent accompany the sale of any such product(s) or information.

Stability characteristics, reliability

After the following tests the filter shall meet the whole specification:

1. Shock: 500 g, 1 ms, half sine wave, 3 shocks each plane;
DIN IEC 68 T2 - 27
2. Vibration: 10 Hz to 2000 Hz, 0.35 mm or 5 g respectively, 1 octave per min, 10 cycles per plane, 3 planes; DIN IEC 68 T2 - 6
3. Change of temperature: -55 °C to 125 °C / 15 min. each / 100 cycles
DIN IEC 68 part 2 – 14 Test N
4. Resistance to solder heat (reflow): reflow possible: three times max.;
for temperature conditions, see page 4: "Air reflow temperature conditions"
5. ESD: SAW devices are electrostatic discharge (ESD) sensitive devices

This filter is RoHS compliant (2011/65/EU)

Packing

Tape & Reel: IEC 286 – 3, with exception of value for N and minimum bending radius;
tape type II, embossed carrier tape with top cover tape on the upper side;

max. pieces of filters per reel:	3000
reel of empty components at start:	min. 300 mm
reel of empty components at start including leader:	min. 500 mm
trailer:	min. 300 mm

Tape (all dimensions in mm)

- W : 12,00 ± 0,3
- Po : 4,00 ± 0,1
- Do : 1,50 +0,1/-0
- E : 1,75 ± 0,1
- F : 5,50 ± 0,05
- G(min) : 0,75
- P2 : 2,00 ± 0,05
- P1 : 8,00 ± 0,1
- D1(min) : 1,50
- Ao : 4,30 ± 0,1
- Bo : 4,30 ± 0,1
- Ct : 9,5 ± 0,1

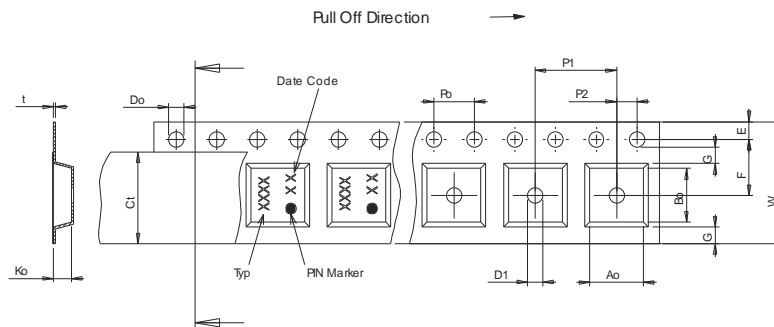

Reel (all dimensions in mm)

- A : 330 or 180
- W1 : 12,4 +2/-0
- W2(max) : 18,4
- N(min) : 50
- C : 13,0 +0,5/-0,2

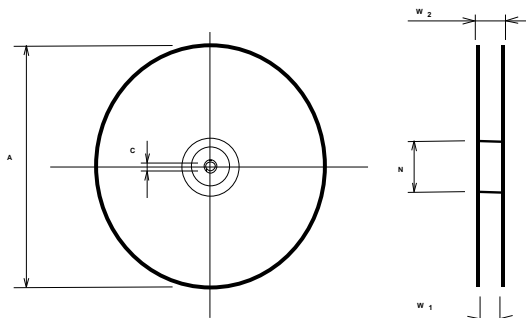

The minimum bending radius is 45 mm.

Microchip Frequency Technology GmbH
Potsdamer Straße 18
D 14 513 TELTOW / Germany
Tel: (+49) 3328 4784-0 / Fax: (+49) 3328 4784-30

Microchip Frequency Technology GmbH reserves the right to make changes to the product(s) and/or information contained herein without notice. No liability is assumed as a result of their use or application. No rights under any patent accompany the sale of any such product(s) or information.

Air reflow temperature conditions

Conditions	Exposure
Average ramp-up rate (30°C to 217°C)	less than 3°C/second
> 100°C	between 300 and 600 seconds
> 150°C	between 240 and 500 seconds
> 217°C	between 30 and 150 seconds
Peak temperature	max. 260°C
Time within 5°C of actual peak temperature	between 10 and 30 seconds
Cool-down rate (Peak to 50°C)	less than 6°C/second
Time from 30°C to Peak temperature	no greater than 300 seconds

Chip-mount air reflow profile

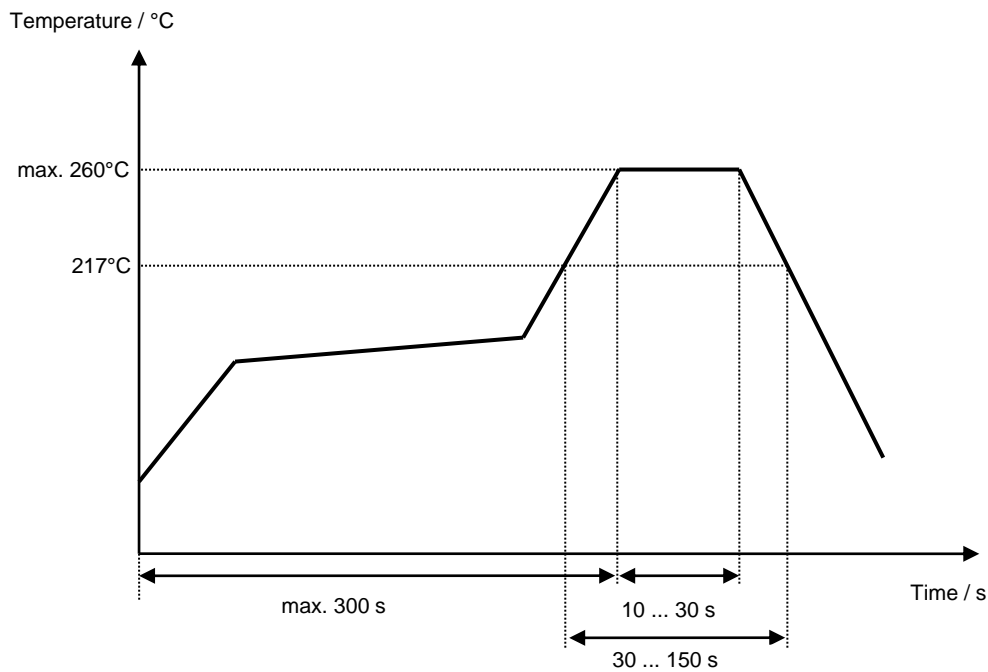

Microchip Frequency Technology GmbH
Potsdamer Straße 18
D 14 513 TELTOW / Germany
Tel: (+49) 3328 4784-0 / Fax: (+49) 3328 4784-30

Microchip Frequency Technology GmbH reserves the right to make changes to the product(s) and/or information contained herein without notice. No liability is assumed as a result of their use or application. No rights under any patent accompany the sale of any such product(s) or information.

Microchip**Filter specification****TFS 522****5/5****History**

Version	Reason of Changes	Name	Date
1.0	Generation of development specification	Springfeldt	14.04.2004
1.1	Change of absolute attenuation $f_N + 149 \dots 300$ MHz Change insertion loss	Strehl	20.01.2005
1.2	Change stability characteristics Add typical values and filter characteristic Generation of filter specification	Strehl	09.05.2005
1.3	Add IIP3 and change stability characteristics	Strehl	12.07.2006
1.4	Maximum input power updated	Kortenbeutel	07.01.2014
1.5	Maximum input power updated Typos corrected	Molke	17.11.2015

Microchip Frequency Technology GmbH
Potsdamer Straße 18
D 14 513 TELTOW / Germany
Tel: (+49) 3328 4784-0 / Fax: (+49) 3328 4784-30

Microchip Frequency Technology GmbH reserves the right to make changes to the product(s) and/or information contained herein without notice. No liability is assumed as a result of their use or application. No rights under any patent accompany the sale of any such product(s) or information.