

Microchip

Filter specification

TFS70BE

1/5

Measurement condition

Ambient temperature T_A :	23	°C
Input power level:	0	dBm
Terminating impedance: *		
Input:	1.6 kΩ -7.7 pF	
Output:	1.75 kΩ -7.5 pF	

Characteristics

Remark:

The reference level for the relative attenuation a_{rel} of the TFS 70BE is the minimum of the pass band attenuation a_{min} . The minimum of the pass band attenuation a_{min} is defined as the insertion loss a_e . The centre frequency f_C is the arithmetic mean value of the upper and lower frequencies at the 3 dB filter attenuation level relative to the insertion loss a_e . The nominal frequency f_N is fixed at 70.0 MHz without any tolerance. The given values for both the relative attenuation a_{rel} and the group delay ripple have to be achieved at the frequencies given below even if the centre frequency f_C is shifted due to the temperature coefficient of frequency TC_f in the operating temperature range and due to a production tolerance for the centre frequency f_C .

D a t a		typ. value		tolerance / limit		
Insertion loss (reference level)	a_e	13.3	dB	max.	15.0	dB
Nominal frequency	f_N	-			70.0	MHz
Centre frequency at ambient temperature	f_C	70.0	MHz		-	
Pass band	PB	-		$f_N \pm$	0.5	MHz
Pass band variation		0.4	dB	max.	0.8	dB
Amplitude ripple in any 112.5 kHz segment in PB		0.15	dB	max.	0.5	dB
Relative attenuation	a_{rel}					
f_N ... $f_N \pm$	0.5 MHz	0.4	dB	max.	0.8	dB
$f_N \pm$ 1.1 MHz ... $f_N \pm$ 1.5 MHz	1.5 MHz	42	dB	min.	37	dB
$f_N \pm$ 1.5 MHz ... $f_N \pm$ 3.0 MHz	3.0 MHz	42	dB	min.	40	dB
0.3 MHz ... $f_N -$ 3.0 MHz	3.0 MHz	53	dB	min.	50	dB
$f_N +$ 3.0 MHz ... $f_N +$ 1.0 GHz	1.0 GHz	52	dB	min.	50	dB
Group delay	at f_N	2.35	µs	max.	4	µs
Group delay ripple within PB (in any 112.5 KHz segment in PB)		70	ns	max.	120	ns
Phase linearity within PB (in any 112.5 KHz segment in PB)	p-p	2.0	deg	max.	5	deg
Input power level		-		max.	23 **	dBm
Operating temperature range	OTR	-			- 40 °C ... + 70 °C	
Storage temperature range		-			- 55 °C ... +125 °C	
Frequency inversion temperature		25	°C		-	
Temperature coefficient of frequency	TC_f ***	- 0.036	ppm/K ²		-	

*) The terminating impedances depend on parasitics and q-values of matching elements and the board used, and are to be understood as reference values only. Should there be additional questions do not hesitate to ask for an application note or contact our design team.

***) This power level is only allowed for short term operation (10% of the life time), the max. input power for continuous operation is max.15dBm only

***) $\Delta f = TC_f(T - T_0)^2 f_N$

Generated: _____

Checked / Approved: _____

Microchip Frequency Technology GmbH
Potsdamer Straße 18
D 14 513 TELTOW / Germany
Tel: (+49) 3328 4784-0 / Fax: (+49) 3328 4784-30

Microchip Frequency Technology GmbH reserves the right to make changes to the product(s) and/or information contained herein without notice. No liability is assumed as a result of their use or application. No rights under any patent accompany the sale of any such product(s) or information.

Filter characteristic

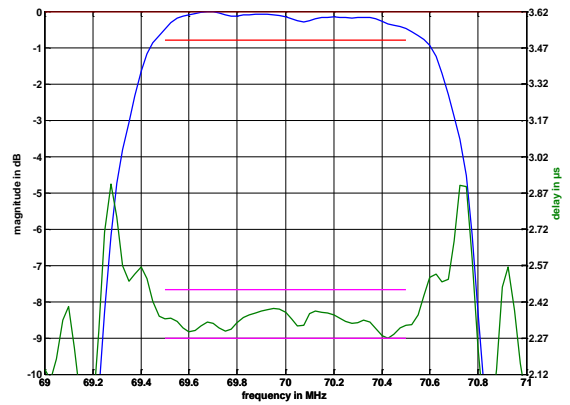
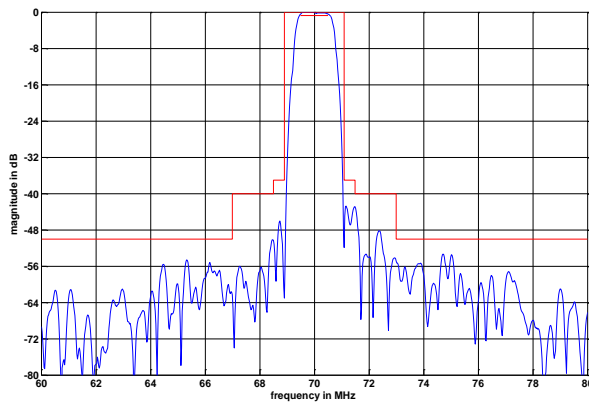

Construction and pin connection

(All dimensions in mm)

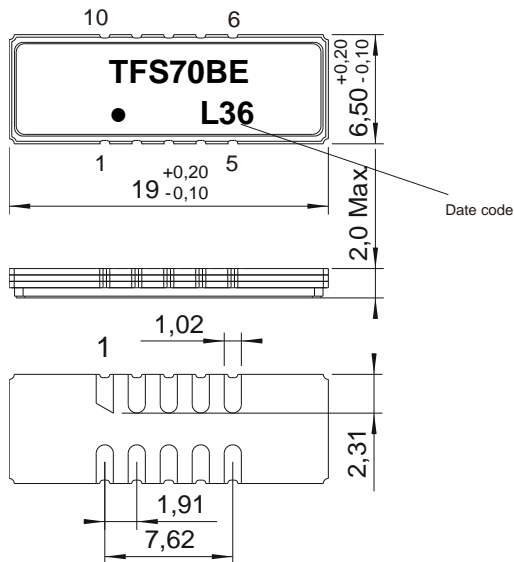

- 1 Input
- 2 Ground
- 3 Ground
- 4 Ground
- 5 Output
- 6 Output
- 7 Ground
- 8 Ground
- 9 Ground
- 10 Input

Date code: Year + week

- L 2019
- M 2020
- N 2021
- ...

50 Ω Test circuit

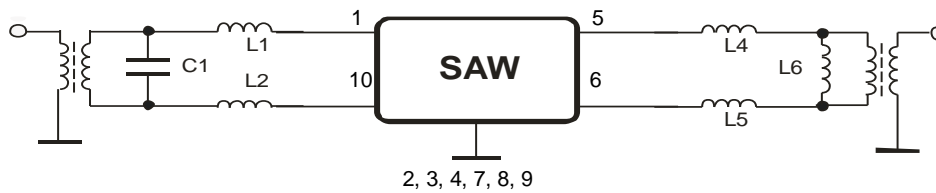

Microchip Frequency Technology GmbH
 Potsdamer Straße 18
 D 14 513 TELTOW / Germany
 Tel: (+49) 3328 4784-0 / Fax: (+49) 3328 4784-30

Microchip Frequency Technology GmbH reserves the right to make changes to the product(s) and/or information contained herein without notice. No liability is assumed as a result of their use or application. No rights under any patent accompany the sale of any such product(s) or information.

Stability characteristics, reliability

After the following tests the filter shall meet the whole specification:

1. Shock: 500 g, 1 ms, half sine wave, 3 shocks each plane;
DIN IEC 60068 T2 - 27
2. Vibration: 10 Hz to 2000 Hz, 0.35 mm or 5 g respectively, 1 octave per min, 10 cycles per plane, 3 planes; DIN IEC 60068 T2 - 6
3. Change of temperature: -55 °C to 125 °C / 15 min. each / 100 cycles
DIN IEC 60068 part 2 – 14 Test N 6
4. Resistance to solder heat (reflow): reflow possible: three times max.;
for temperature conditions refer to the attached "Air reflow temperature conditions" on page 4;
5. SAW devices are Electrostatic Discharge (ESD) sensitive devices.

This filter is RoHS compliant (2011/65/EU)

Packing

- Tape & Reel: IEC 286 – 3, with exception of value for N and minimum bending radius;
tape type II, embossed carrier tape with top cover tape on the upper side;
- reel of empty components at start: min. 300 mm
 reel of empty components at start including leader: min. 500 mm
 trailer: min. 300 mm

Tape (all dimensions in mm)

W	:	32.00	±0.3
Po	:	4.00	±0.1
Do	:	1.50	+0.1/-0
E	:	1.75	±0.1
F	:	14.20	±0.1
G(min)	:		
P2	:	2.00	±0.1
P1	:	12.00	±0.1
D1(min)	:	2.00	
Ao	:	7.10	±0.1
Bo	:	19.60	±0.1
Ct	:	25.50	±0.1
Ko	:	2.00	±0.1
t	:	0.30	±0.05
2	:		

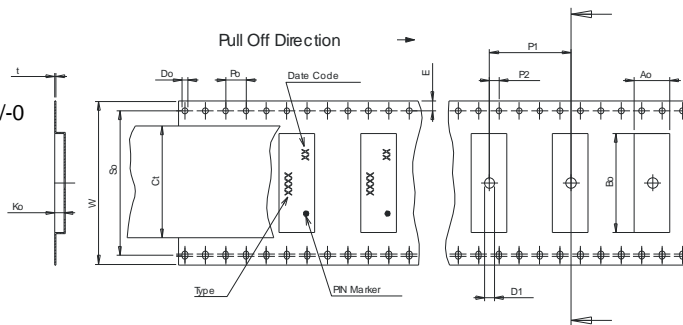

Reel (all dimensions in mm)

A	:	330 or 180
W1	:	32.4 +2/-0
W2(max)	:	38.40
N(min)	:	100.00
C	:	13.0 +0.5/-0.2

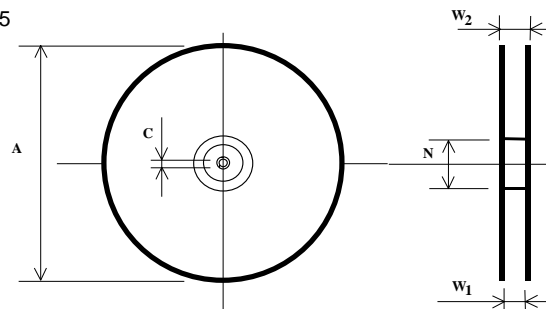

The minimum bending radius is 45 mm.

Microchip Frequency Technology GmbH
Potsdamer Straße 18
D 14 513 TELTOW / Germany
Tel: (+49) 3328 4784-0 / Fax: (+49) 3328 4784-30

Microchip Frequency Technology GmbH reserves the right to make changes to the product(s) and/or information contained herein without notice. No liability is assumed as a result of their use or application. No rights under any patent accompany the sale of any such product(s) or information.

Air reflow temperature conditions

Conditions	Exposure
Average ramp-up rate (30 °C to 217 °C)	less than 3 °C / second
> 100 °C	between 300 and 600 seconds
> 150 °C	between 240 and 500 seconds
> 217 °C	between 30 and 150 seconds
Peak temperature	max. 260 °C
Time within 5 °C of actual peak temperature	between 10 and 30 seconds
Cool-down rate (Peak to 50 °C)	less than 6 °C / second
Time from 30 °C to Peak temperature	no greater than 300 seconds

Chip-mount air reflow profile

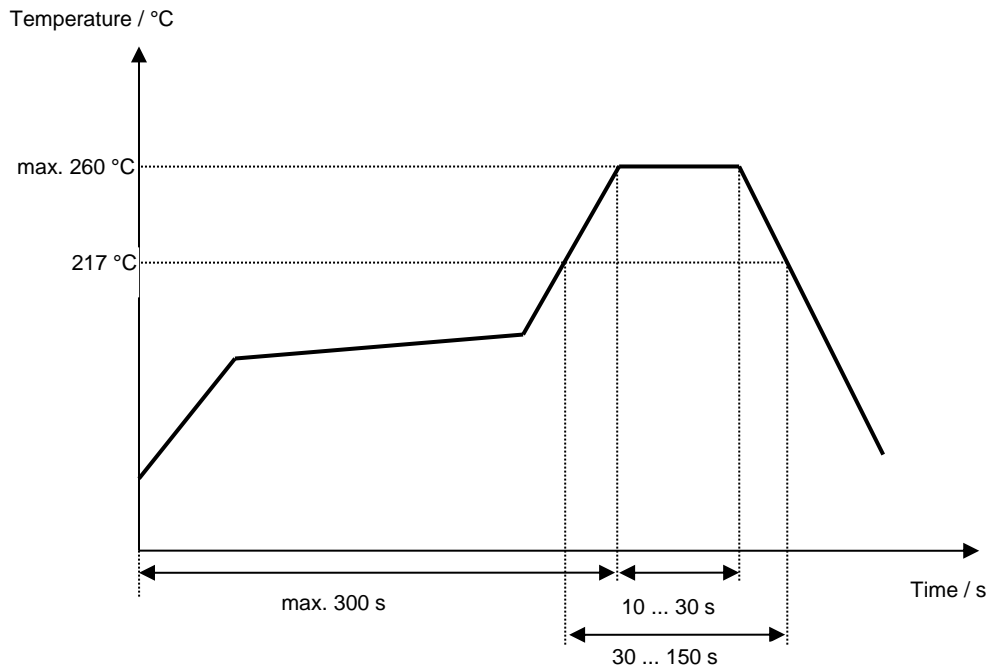

Microchip Frequency Technology GmbH
Potsdamer Straße 18
D 14 513 TELTOW / Germany
Tel: (+49) 3328 4784-0 / Fax: (+49) 3328 4784-30

Microchip Frequency Technology GmbH reserves the right to make changes to the product(s) and/or information contained herein without notice. No liability is assumed as a result of their use or application. No rights under any patent accompany the sale of any such product(s) or information.

Microchip**Filter specification****TFS70BE****5/5****History**

Version	Reason of Changes	Name	Date
1.0	- Generation of development specification	Strehl	07.11.2007
1.1	- Correct group delay ripple within PB - Correct pass band ripple - Correct phase linearity within PB - Add terminating impedances - Add typical values - Add filter characteristics - Add matching circuit - Generation of filter specification	Strehl	20.05.2008
1.2	- Remove previous screening requirements, (now with std screening only).	TCUK	26.11.2012
2.0	- correct typo in terminating impedance	Bonnen	05.09.2019

Microchip Frequency Technology GmbH
Potsdamer Straße 18
D 14 513 TELTOW / Germany
Tel: (+49) 3328 4784-0 / Fax: (+49) 3328 4784-30

Microchip Frequency Technology GmbH reserves the right to make changes to the product(s) and/or information contained herein without notice. No liability is assumed as a result of their use or application. No rights under any patent accompany the sale of any such product(s) or information.