

<b>Microchip</b>	<b>Filter specification</b>	<b>TFS535A</b>	<b>1/5</b>
------------------	-----------------------------	----------------	------------

**Measurement condition**

Ambient temperature $T_A$ :	23	°C
Input power level:	0	dBm
Terminating impedance: *		
Input:	200 $\Omega$	- 5.3 pF
Output:	232 $\Omega$	- 4.3 pF

**Characteristics**

Remark:

The reference level for the relative attenuation  $a_{rel}$  of the TFS535A is the minimum of the pass band attenuation. This value is defined as the insertion loss  $a_e$ . The nominal frequency  $f_N$  is fixed at 535 MHz without any tolerance. The values of relative attenuation  $a_{rel}$  are guaranteed over the whole operating temperature range. The frequency shift of the filter within the operating temperature range is included in the production tolerance scheme.

D a t a		typ. value	tolerance / limit		
<b>Insertion loss</b> (reference level)	$a_e$	8.3	max.	11	dB
<b>Nominal frequency</b>	$f_N$			535	MHz
<b>Passband</b>	PB		$f_N \pm$	5	MHz
<b>Amplitude ripple within PB</b>	p-p	0.6	max.	1	dB
<b>Relative attenuation</b>	$a_{rel}$				
$f_N \dots f_N \pm 5$ MHz		0.6	max.	1	dB
$f_N \pm 100$ MHz $\dots f_N \pm 18$ MHz		46	min.	40	dB
$f_N - 18$ MHz $\dots f_N - 15$ MHz		42	min.	35	dB
$f_N + 15$ MHz $\dots f_N + 18$ MHz		43	min.	25	dB
<b>Group delay ripple within PB</b>	p-p	23	max.	35	ns
<b>Return loss within PB</b>		16	min.	10	dB
<b>Input power level</b>			max.	10	dBm
<b>Operating temperature range</b>	OTR			-40 °C ... +85 °C	
<b>Storage temperature range</b>				-55 °C ... +125 °C	
<b>Temperature coefficient of frequency</b>	$TC_f^{**}$	-18		ppm/K	

\*) The terminating impedances depend on parasitics and q-values of matching elements and the board used and are to be understood as reference values only. Should there be additional questions do not hesitate to ask for an application note or contact our design team.

\*\*\*)  $\Delta f = TC_f(T - T_A)f_N$

**Generated:** \_\_\_\_\_

**Checked / Approved:** \_\_\_\_\_

---

**Microchip Frequency Technology GmbH**  
**Potsdamer Straße 18**  
**D 14 513 TELTOW / Germany**  
**Tel: (+49) 3328 4784-0 / Fax: (+49) 3328 4784-30**

Microchip Frequency Technology GmbH reserves the right to make changes to the product(s) and/or information contained herein without notice. No liability is assumed as a result of their use or application. No rights under any patent accompany the sale of any such product(s) or information.

**Filter characteristic**

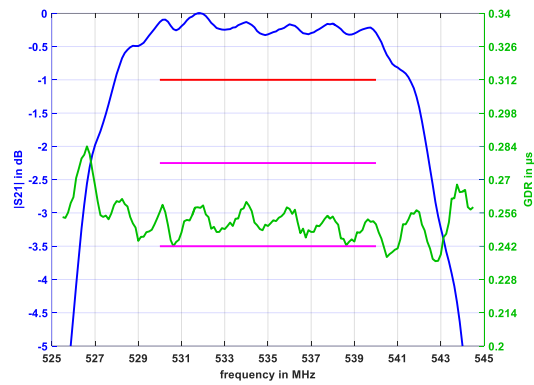
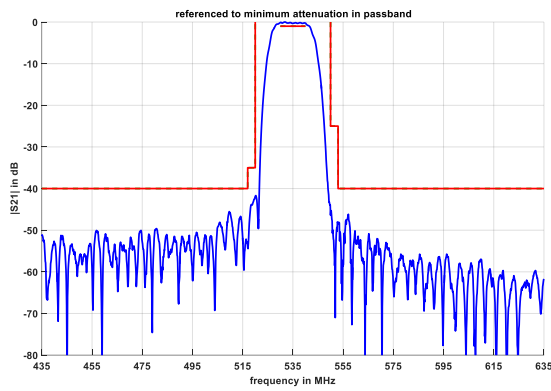

**Construction and pin connection**

(All dimensions in mm)

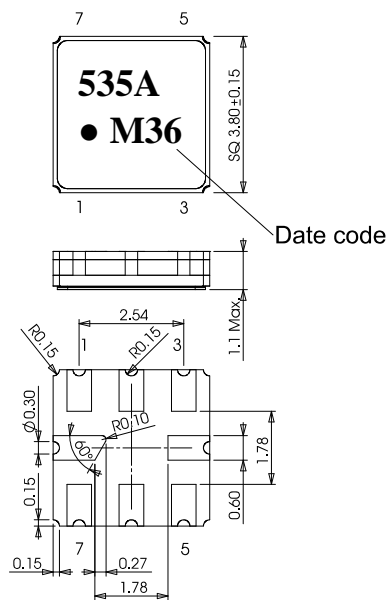

1	Ground
2	Ground
3	Output
4	Ground
5	Ground
6	Ground
7	Input
8	Ground

Date code: Year + week

M	2020
N	2021
P	2022

**50 Ohm Test circuit**

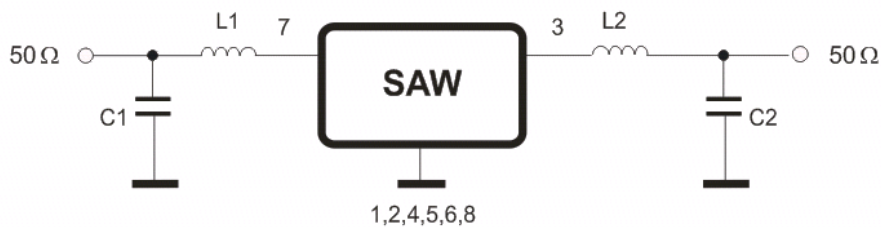

**Microchip Frequency Technology GmbH**  
**Potsdamer Straße 18**  
**D 14 513 TELTOW / Germany**  
**Tel: (+49) 3328 4784-0 / Fax: (+49) 3328 4784-30**

Microchip Frequency Technology GmbH reserves the right to make changes to the product(s) and/or information contained herein without notice. No liability is assumed as a result of their use or application. No rights under any patent accompany the sale of any such product(s) or information.

**Stability characteristics, reliability**

After the following tests the filter shall meet the whole specification:

1. Shock: 500 g, 1 ms, half sine wave, 3 shocks each plane;  
DIN IEC 60068 T2 - 27
2. Vibration: 10 Hz to 2000 Hz, 0.35 mm or 5 g respectively, 1 octave per min, 10 cycles per plane, 3 planes; DIN IEC 60068 T2 - 6
3. Change of temperature: -55 °C to 125 °C / 15 min. each / 100 cycles  
DIN IEC 60068 part 2 – 14 Test N
4. Resistance to solder heat (reflow): reflow possible: three times max.;  
for temperature conditions refer to the attached "Air reflow temperature conditions" on page 4;
5. SAW devices are Electrostatic Discharge (ESD) sensitive devices.

This filter is RoHS compliant (2011/65/EU+2015/863/EU)

**Packing**

Tape & Reel: IEC 286 – 3, with exception of value for N and minimum bending radius;  
tape type II, embossed carrier tape with top cover tape on the upper side;

reel of empty components at start: min. 300 mm  
reel of empty components at start including leader: min. 500 mm  
trailer: min. 300 mm

**Tape (all dimensions in mm)**

- W : 12.00 ±0.3
- Po : 4.00 ±0.1
- Do : 1.50 +0.1/-0
- E : 1.75 ±0.1
- F : 5.50 ±0.05
- G(min) : 0.75
- P2 : 2.00 ±0.05
- P1 : 8.00 ±0.1
- D1(min) : 1.50
- Ao : 4.30 ±0.1
- Bo : 4.30 ±0.1
- Ct : 9.2 ±0.1
- Ko : 1.80 ±0.1
- t : 0.30 ±0.05

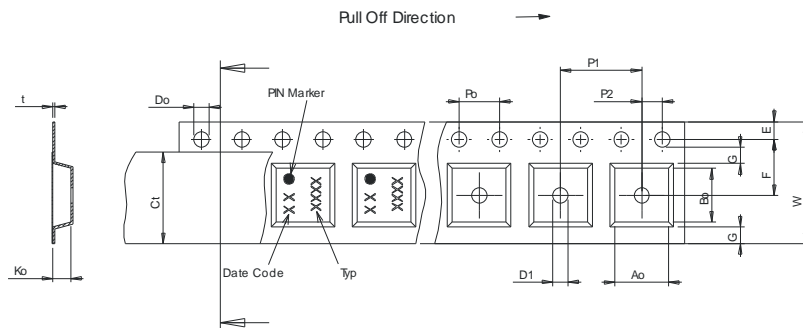

**Reel (all dimensions in mm)**

- A : 330 or 180
- W1 : 12.4 +2/-0
- W2(max) : 18.40
- N(min) : 50.00
- C : 13.0 +0.5/-0.2

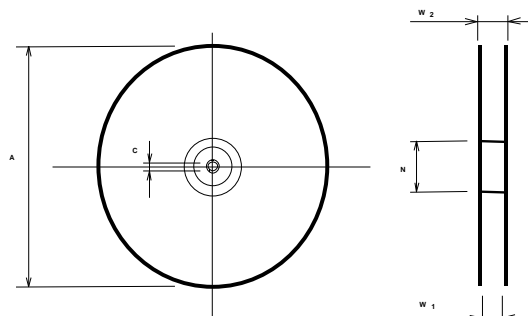

The minimum bending radius is 45 mm.

**Microchip Frequency Technology GmbH**

**Potsdamer Straße 18**

**D 14 513 TELTOW / Germany**

**Tel: (+49) 3328 4784-0 / Fax: (+49) 3328 4784-30**

Microchip Frequency Technology GmbH reserves the right to make changes to the product(s) and/or information contained herein without notice. No liability is assumed as a result of their use or application. No rights under any patent accompany the sale of any such product(s) or information.

**Air reflow temperature conditions**

<b>Conditions</b>	<b>Exposure</b>
Average ramp-up rate (30 °C to 217 °C)	less than 3 °C / second
> 100 °C	between 300 and 600 seconds
> 150 °C	between 240 and 500 seconds
> 217 °C	between 30 and 150 seconds
Peak temperature	max. 260 °C
Time within 5 °C of actual peak temperature	between 10 and 30 seconds
Cool-down rate (Peak to 50 °C)	less than 6 °C / second
Time from 30 °C to Peak temperature	no greater than 300 seconds

**Chip-mount air reflow profile**

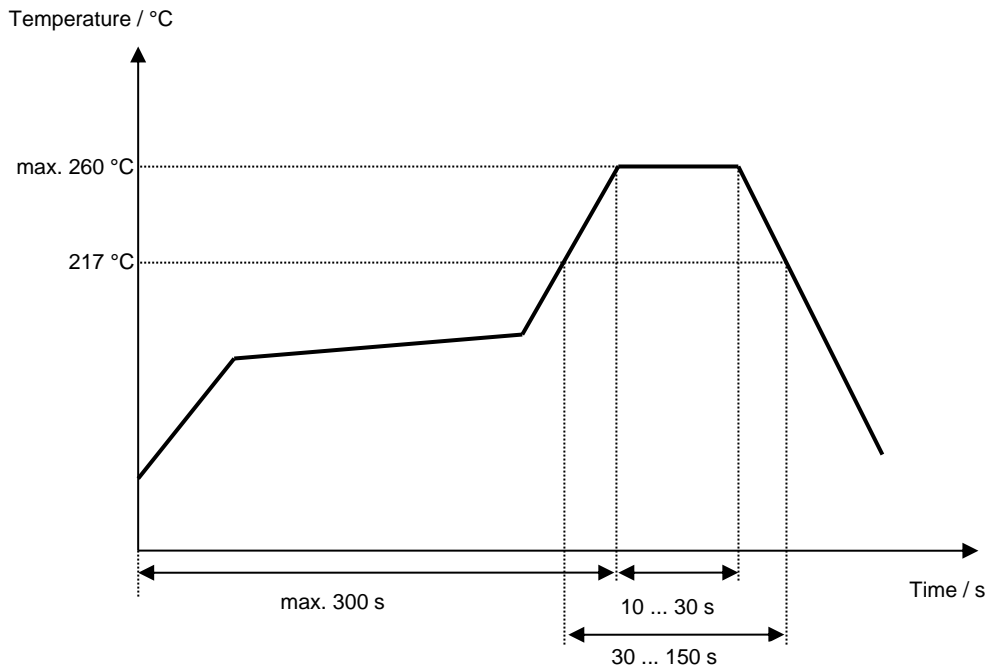

**Microchip Frequency Technology GmbH**  
**Potsdamer Straße 18**  
**D 14 513 TELTOW / Germany**  
**Tel: (+49) 3328 4784-0 / Fax: (+49) 3328 4784-30**

Microchip Frequency Technology GmbH reserves the right to make changes to the product(s) and/or information contained herein without notice. No liability is assumed as a result of their use or application. No rights under any patent accompany the sale of any such product(s) or information.

---

**Microchip****Filter specification****TFS535A****5/5**

---

**History**

<b>Version</b>	<b>Reason of Changes</b>	<b>Name</b>	<b>Date</b>
1.0	- Generation of development specification based on 535_rfq2 (sim1)	P. Jaster	24.04.2020
1.1	- pinning updated	P. Jaster	28.04.2020
2.0	- changed pin 7 to input and pin 3 to output	P. Jaster	29.04.2020
2.1	- add typ. values, plots and move to filter specification. - decided to stay with fN-18MHz...fN-15MHz 35dB min rather than 40dB min target as we have a sidelobe at ~ 520MHz - change tape and reel dimensions	Jaffer	03.09.2020

---

**Microchip Frequency Technology GmbH**  
**Potsdamer Straße 18**  
**D 14 513 TELTOW / Germany**  
**Tel: (+49) 3328 4784-0 / Fax: (+49) 3328 4784-30**

---

Microchip Frequency Technology GmbH reserves the right to make changes to the product(s) and/or information contained herein without notice. No liability is assumed as a result of their use or application. No rights under any patent accompany the sale of any such product(s) or information.