

**Microchip****Filter Specification****TFS 471A****1/5****Measurement condition**

Ambient temperature:	23 °C
Input power level:	0 dBm
Terminating impedances *	
Input:	270 Ω    -1pF
Output:	270 Ω    -1pF

**Characteristics**

## Remark:

Reference level for the relative attenuation  $a_{rel}$  of the TFS471A is the maximum of the attenuation within the usable signal bandwidth  $a_{max}$ . The maximum of the attenuation within the usable signal bandwidth is defined as the insertion loss  $a_e$ . The centre frequency  $f_c$  is the arithmetic mean value of the upper and lower frequencies at the 3 dB filter attenuation level relative to the insertion loss  $a_e$ . The nominal frequency  $f_N$  is fixed at 471,55 MHz without tolerance. The given values for the relative attenuation have to be reached at the frequencies given below even if the centre frequency  $f_c$  is shifted due to the temperature coefficient of frequency  $TC_f$  in the operating temperature range and due to a production tolerance for the centre frequency  $f_c$ .

<b>D a t a</b>		<b>typ. value</b>	<b>Variation / Limitation</b>
<b>Insertion loss</b> (Reference level)	$a_e = a_{max}$	3,6 dB	max. 5 dB
<b>Nominal frequency</b>	$f_N$	-	471,55 MHz
<b>Centre frequency</b>	$f_c$	471,55 MHz	-
<b>3 dB - bandwidth</b>	BW	280 kHz	-
<b>Usable signal bandwidth</b>		-	min. $f_N \pm 10$ kHz
<b>Relative attenuation</b> $f_N + 910$ kHz	$a_{rel}$	64 dB	min. 52 dB
<b>Temperature coefficient of frequency</b>	$TC_f$ **	-0,036 ppm/K <sup>2</sup>	-
<b>Frequency inversion temperature</b>	$T_0$	+ 25 °C	-
<b>Operating temperature range</b>		-	- 10°C ... + 50°C
<b>Storage temperature range</b>		-	- 40°C ... + 85°C

\*) The terminating impedances depend on parasitics and q-values of matching elements and the board used, and are to be understood as reference values only. Should there be additional questions do not hesitate to ask for an application note or contact our design team.

\*\*\*)  $\Delta f(\text{Hz}) = TC_f(\text{ppm/K}^2) \times (T - T_0)^2 \times f_{T_0}(\text{MHz})$

**generated:** \_\_\_\_\_

**checked / approved:** \_\_\_\_\_

**Microchip Frequency Technology GmbH**  
**Potsdamer Straße 18**  
**D 14 513 TELTOW / Germany**  
**Tel: (+49) 3328 4784-0 / Fax: (+49) 3328 4784-30**

Microchip Frequency Technology GmbH reserves the right to make changes to the product(s) and/or information contained herein without notice. No liability is assumed as a result of their use or application. No rights under any patent accompany the sale of any such product(s) or information.

**Construction and pin connection**

(All dimensions in mm)

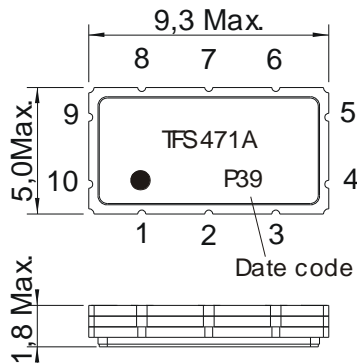

- 1 Ground
- 2 Ground
- 3 Ground
- 4 Ground
- 5 Output
- 6 Ground
- 7 Ground
- 8 Ground
- 9 Ground
- 10 Input

Datecode	Year + week
M	2000
N	2001
P	2002
...	

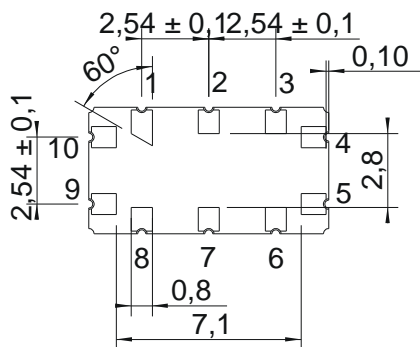

**50 Ω test circuit 1**

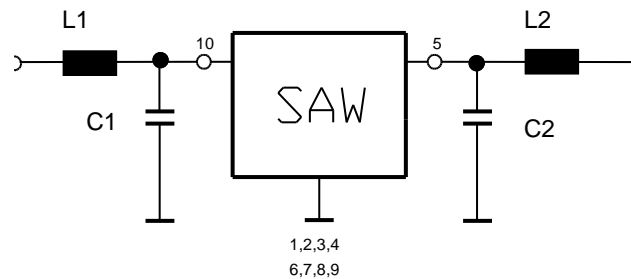

**50 Ω test circuit 2**

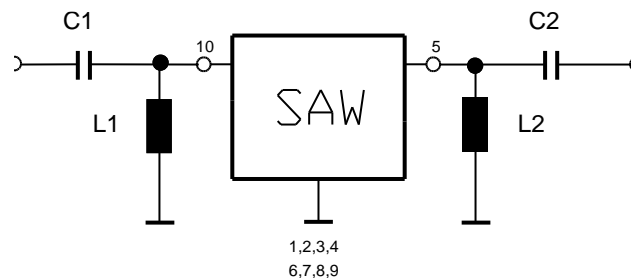

**Microchip Frequency Technology GmbH**

**Potsdamer Straße 18**

**D 14 513 TELTOW / Germany**

**Tel: (+49) 3328 4784-0 / Fax: (+49) 3328 4784-30**

Microchip Frequency Technology GmbH reserves the right to make changes to the product(s) and/or information contained herein without notice. No liability is assumed as a result of their use or application. No rights under any patent accompany the sale of any such product(s) or information.

**Stability Characteristics**

After the following tests the filter shall meet the whole specification:

1. Shock: 500g, 18 ms, half sine wave, 3 shocks each plane;  
DIN IEC 68 T2 - 27
2. Vibration: 10 Hz to 500 Hz, 1,5 mm or 20g respectively, 1 octave per min, 10 cycles per plan, 3 plans;  
DIN IEC 68 T2 - 6
3. Change of temperature: -55 °C to 125°C / 30 min. each / 10 cycles  
DIN IEC 68 part 2 – 14 Test N
4. Resistance to solder heat (reflow): reflow possible: twice max. ;  
for temperature conditions refer to the attached "Air reflow temperature conditions" on page 4;

**Packing**

Tape & Reel: IEC 286 - 3, with exception of value for N and minimum bending radius;  
tape type II, embossed carrier tape with top cover tape on the upper side;

max. pieces of filters per reel:	3000
Reel of empty components at start:	min 300 mm
Reel of empty components at start including leader:	min 500 mm
Trailer	min 300 mm

**Tape (all dimensions in mm)**

- W : 16 ± 0,3
- Po : 4 ± 0,1
- Do : 1,5 ± 0,1
- E : 1,75 ± 0,1
- F : 7,5 ± 0,1
- G (min) : 0,6
- P2 : 2 ± 0,1
- P1 : 8 ± 0,1
- D1(min) : 1,5
- Ao : 5,3 ± 0,1
- Bo : 9,7 ± 0,1
- CT : 13,5 ± 0,1

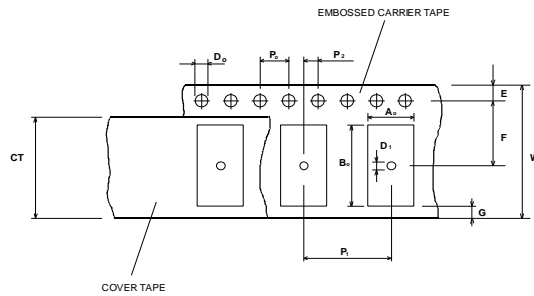

**Reel (all dimensions in mm):**

- A : 330
- W1 : 16,4 +2
- W2 (max) : 22,4
- N (min) : 50
- C : 13 + 0,5 / - 0,2

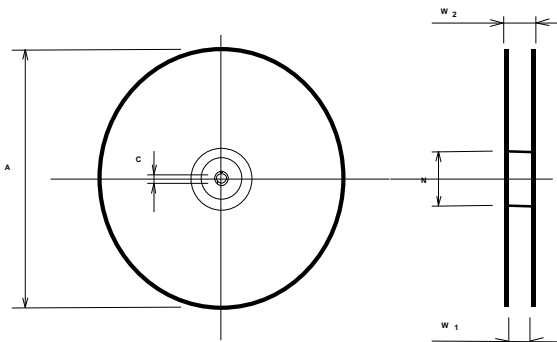

The minimum bending radius is 45 mm. The mounting surface of the filters faces the bottom side of the embossed carrier tape. Markings on the filters can be read if the upper side of the carrier tape is regarded with the sprocket holes on its right.

**Microchip Frequency Technology GmbH**

**Potsdamer Straße 18**

**D 14 513 TELTOW / Germany**

**Tel: (+49) 3328 4784-0 / Fax: (+49) 3328 4784-30**

Microchip Frequency Technology GmbH reserves the right to make changes to the product(s) and/or information contained herein without notice. No liability is assumed as a result of their use or application. No rights under any patent accompany the sale of any such product(s) or information.

**Air reflow temperature conditions**

1st and 2nd air reflow profile

<b>Name:</b>	pre-heating periods	main-heating periods	peak temperature
<b>Temperature:</b>	150 °C - 170 °C	over 200 °C	255 °C ± 5 °C
<b>Time:</b>	60 sec. - 90 sec.	20 sec. - 25 sec.	

**Chip-mount air reflow profile**

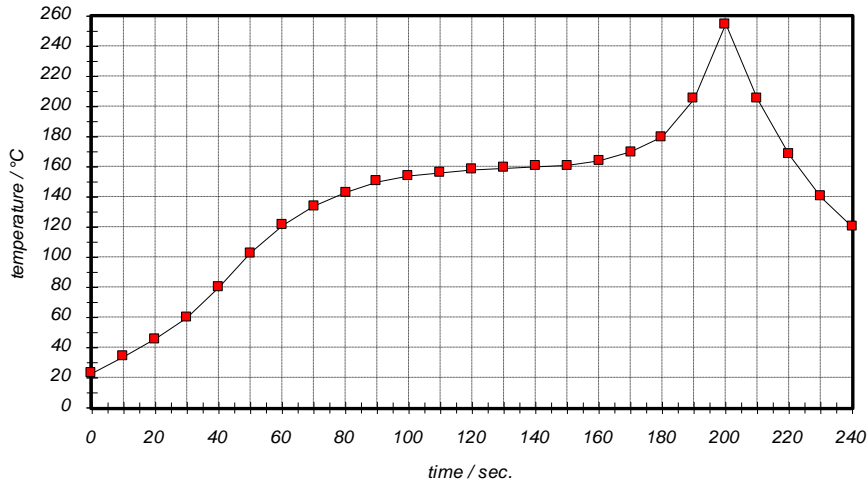

Table for temperature vs. time during the air reflow process

Tolerance of temperatures: ± 5 °C

time / sec.	temperature / °C	time / sec.	temperature / °C
0	23	140	160
10	34	150	161
20	46	160	164
30	60	170	170
40	80	180	180
50	103	190	205
60	121	195	230
70	134	200	255
80	143	205	230
90	150	210	205
100	154	215	180
110	156	220	165
120	158	230	140
130	159	240	120

**Microchip Frequency Technology GmbH**  
**Potsdamer Straße 18**  
**D 14 513 TELTOW / Germany**  
**Tel: (+49) 3328 4784-0 / Fax: (+49) 3328 4784-30**

Microchip Frequency Technology GmbH reserves the right to make changes to the product(s) and/or information contained herein without notice. No liability is assumed as a result of their use or application. No rights under any patent accompany the sale of any such product(s) or information.

---

**Microchip****Filter Specification****TFS 471A****5/5**

---

**History**

<b>Version</b>	<b>Reason of Changes</b>	<b>Name</b>	<b>Date</b>
1.3	Add history. Change remark for characteristic. Add remark for termination impedance. Change footprint of package. Correct stability characteristics. Correct packing information. Change typical values.	Dr. Wall	26.09.2002

---

**Microchip Frequency Technology GmbH**  
**Potsdamer Straße 18**  
**D 14 513 TELTOW / Germany**  
**Tel: (+49) 3328 4784-0 / Fax: (+49) 3328 4784-30**

---

Microchip Frequency Technology GmbH reserves the right to make changes to the product(s) and/or information contained herein without notice. No liability is assumed as a result of their use or application. No rights under any patent accompany the sale of any such product(s) or information.