

Microchip	Filter specification	TFS50A	1/5
------------------	-----------------------------	---------------	------------

Measurement condition

Ambient temperature T_A :	23	°C
Input power level:	0	dBm
Terminating impedance: *		
Input:	451 Ω -21.0 pF	
Output:	471 Ω -22.2 pF	

Characteristics

Remark:

The reference level for the relative attenuation a_{rel} of the TFS50A is the minimum of the pass band attenuation. This value is defined as the insertion loss a_e . The nominal frequency f_N is fixed at 50 MHz without any tolerance. The values of relative attenuation a_{rel} are guaranteed over the whole operating temperature range. The frequency shift of the filter within the operating temperature range is included in the production tolerance scheme.

D a t a	typ. value	tolerance / limit
Insertion loss (reference level)	a_e 11.4	max. 12 dB
Nominal frequency	f_N	50 MHz
Passband	PB	$f_N \pm 5$ MHz
Amplitude ripple within PB	p-p 0.8	max. 1.2 dB
Bandwidth 1 dB	BW 11.6	min. 10 MHz max. 12 MHz
Group delay ripple within PB	p-p 90 ns	max. 180 ns
Relative attenuation	a_{rel}	
$f_N \pm 5$ MHz	0.8	max. 1.2 dB
$f_N - 49$ MHz ... $f_N - 37$ MHz	44 dB	min. 35 dB
$f_N - 37$ MHz ... $f_N - 25$ MHz	54 dB	min. 50 dB
$f_N - 25$ MHz ... $f_N - 20$ MHz	52 dB	min.. 45 dB
$f_N - 20$ MHz ... $f_N - 15$ MHz	45 dB	min.. 40 dB
$f_N - 15$ MHz ... $f_N - 10$ MHz	32 dB	min. 25 dB
$f_N + 10$ MHz ... $f_N + 15$ MHz	30 dB	min. 25 dB
$f_N + 15$ MHz ... $f_N + 20$ MHz	47 dB	min. 40 dB
$f_N + 20$ MHz ... $f_N + 25$ MHz	54 dB	min. 45 dB
$f_N + 25$ MHz ... $f_N + 35$ MHz	57 dB	min. 50 dB
$f_N + 35$ MHz ... $f_N + 85$ MHz	44 dB	min. 40 dB
$f_N + 85$ MHz ... $f_N + 950$ MHz	60 dB	min. 50 dB
Return loss within PB	RL 11	min. 9 dB
Input power level		max. 30 dBm
Operating temperature range	OTR	-40 °C ... +85 °C
Storage temperature range		-55 °C ... +125 °C
Temperature coefficient of frequency	TC_f^{**} -94 ppm/K	-

*) The terminating impedances depend on parasitics and q-values of matching elements and the board used and are to be understood as reference values only. Should there be additional questions do not hesitate to ask for an application note or contact our design team.

***) $\Delta f = TC_f(T - T_A)f_N$

Generated: _____

Checked / Approved: _____

Microchip Frequency Technology GmbH
Potsdamer Straße 18
D 14 513 TELTOW / Germany
Tel: (+49) 3328 4784-0 / Fax: (+49) 3328 4784-30

Microchip Frequency Technology GmbH reserves the right to make changes to the product(s) and/or information contained herein without notice. No liability is assumed as a result of their use or application. No rights under any patent accompany the sale of any such product(s) or information.

Filter characteristic

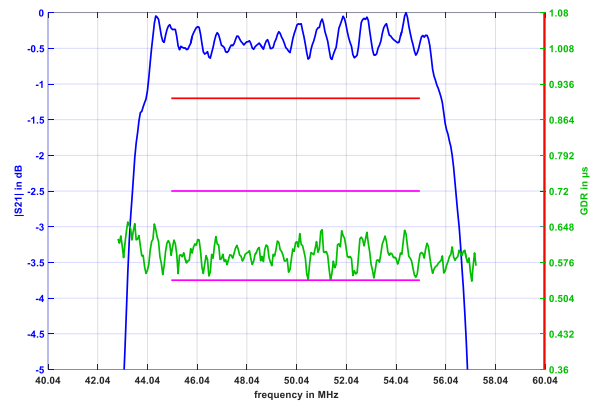
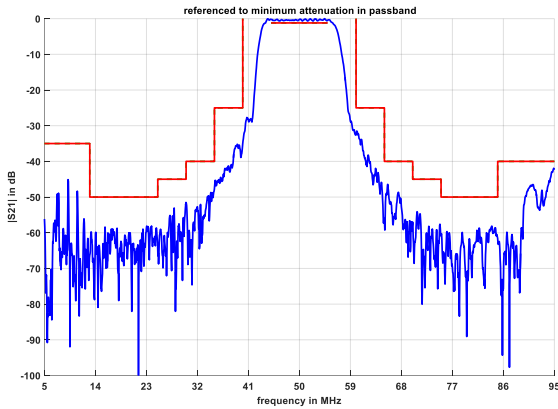

Construction and pin connection

(All dimensions in mm)

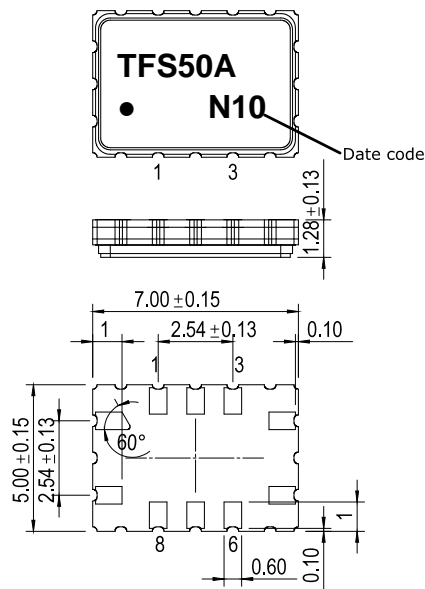

- 1 Ground
- 2 Ground
- 3 Ground
- 4 Output
- 5 Ground
- 6 Ground
- 7 Ground
- 8 Ground
- 9 Input
- 10 Ground

Date code: Year + week
 N 2021
 P 2022
 R 2023
 ...

50 Ω Test circuit

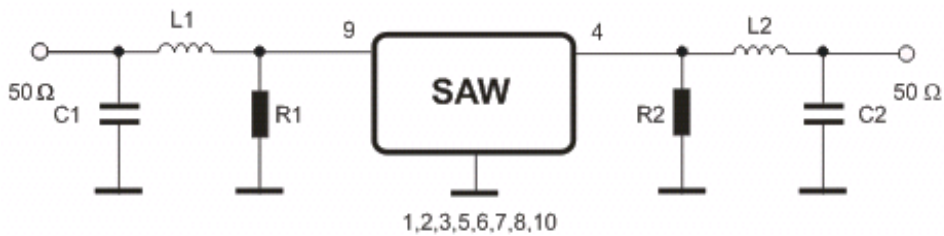

Microchip Frequency Technology GmbH
 Potsdamer Straße 18
 D 14 513 TELTOW / Germany
 Tel: (+49) 3328 4784-0 / Fax: (+49) 3328 4784-30

Microchip Frequency Technology GmbH reserves the right to make changes to the product(s) and/or information contained herein without notice. No liability is assumed as a result of their use or application. No rights under any patent accompany the sale of any such product(s) or information.

Stability characteristics, reliability

After the following tests the filter shall meet the whole specification:

1. Shock: 500 g, 1 ms, half sine wave, 3 shocks each plane;
DIN IEC 60068 T2 - 27
2. Vibration: 10 Hz to 2000 Hz, 0.35 mm or 5 g respectively, 1 octave per min, 10 cycles per plane, 3 planes; DIN IEC 60068 T2 - 6
3. Change of temperature: -55 °C to 125 °C / 15 min. each / 100 cycles
DIN IEC 60068 part 2 – 14 Test N
4. Resistance to solder heat (reflow): reflow possible: three times max.;
for temperature conditions refer to the attached "Air reflow temperature conditions" on page 4;
5. SAW devices are Electrostatic Discharge (ESD) sensitive devices.

This filter is RoHS compliant (2011/65/EU+2015/863/EU)

Packing

Tape & Reel: IEC 286 – 3, with exception of value for N and minimum bending radius;
tape type II, embossed carrier tape with top cover tape on the upper side;

reel of empty components at start: min. 300 mm
reel of empty components at start including leader: min. 500 mm
trailer: min. 300 mm

Tape (all dimensions in mm)

- W : 16.00 +0.3/-0.1
- Po : 4.00 ±0.1
- Do : 1.50 +0.1/-0
- E : 1.75 ±0.1
- F : 7.50 ±0.1
- G(min) : 0.75
- P2 : 2.00 ±0.1
- P1 : 8.00 ±0.1
- D1(min) : 1.50
- Ao : 5.40 ±0.1
- Bo : 7.60 ±0.1
- Ct : 13.30 ±0.1
- Ko : 2.00 ±0.1
- t : 0.30 ±0.05

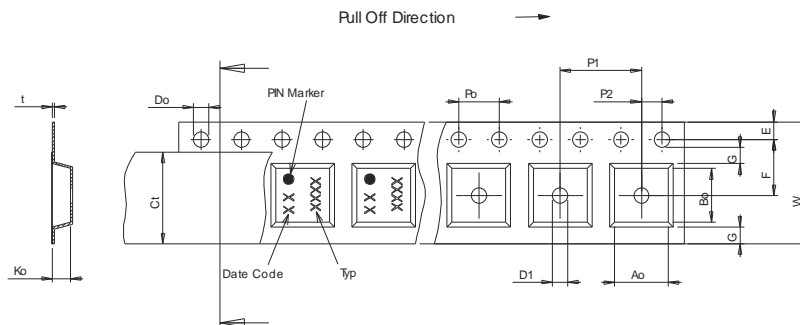

Reel (all dimensions in mm)

- A : 330 or 180
- W1 : 16.4 +2/-0
- W2(max) : 22.40
- N(min) : 50.00
- C : 13.0 +0.5/-0.2

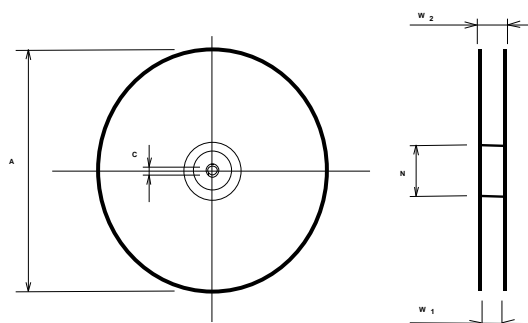

The minimum bending radius is 45 mm.

Microchip Frequency Technology GmbH
Potsdamer Straße 18
D 14 513 TELTOW / Germany
Tel: (+49) 3328 4784-0 / Fax: (+49) 3328 4784-30

Microchip Frequency Technology GmbH reserves the right to make changes to the product(s) and/or information contained herein without notice. No liability is assumed as a result of their use or application. No rights under any patent accompany the sale of any such product(s) or information.

Air reflow temperature conditions

Conditions	Exposure
Average ramp-up rate (30 °C to 217 °C)	less than 3 °C / second
> 100 °C	between 300 and 600 seconds
> 150 °C	between 240 and 500 seconds
> 217 °C	between 30 and 150 seconds
Peak temperature	max. 260 °C
Time within 5 °C of actual peak temperature	between 10 and 30 seconds
Cool-down rate (Peak to 50 °C)	less than 6 °C / second
Time from 30 °C to Peak temperature	no greater than 300 seconds

Chip-mount air reflow profile

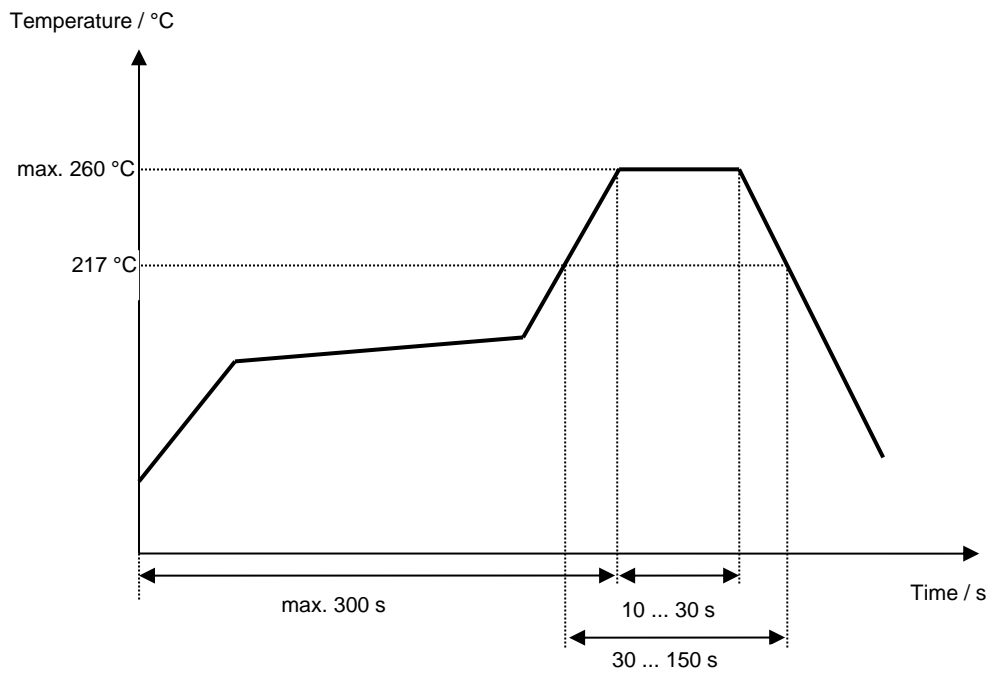

Microchip**Filter specification****TFS50A****5/5****History**

Version	Reason of Changes	Name	Date
1.0	- Generation of development specification	P. Jaster	03.12.2019
2.0	- Change to 10-pad package	Bonnen	09.01.2020
3.0	- Generation of filter specification	Bonnen	12.03.2020
4.0	- Update package drawing to BV100.1.A1-0 (from BV27.1.B3-0)	Jaffer	16.06.2020
5.0	- Add relaxations for: - the amplitude ripple from 1dB to 1.2dB - the group delay ripple from 140ns to 180ns	Bonnen	11.03.2021

Microchip Frequency Technology GmbH
Potsdamer Straße 18
D 14 513 TELTOW / Germany
Tel: (+49) 3328 4784-0 / Fax: (+49) 3328 4784-30

Microchip Frequency Technology GmbH reserves the right to make changes to the product(s) and/or information contained herein without notice. No liability is assumed as a result of their use or application. No rights under any patent accompany the sale of any such product(s) or information.