

10 MHz to 20 GHz Integrated Vector Network Analyzer Front End

FEATURES

- ▶ Wideband integrated bidirectional bridge
 - ▶ Raw directivity: 24.1 dB at 1 GHz, 12.8 dB at 18 GHz
 - ▶ Low insertion loss: 1.1 dB at 1 GHz, 1.9 dB at 18 GHz
 - ▶ Return loss: >12 dB typical
- ▶ SPI configurable LO interface
 - ▶ Divide by 2; multiply by 1, 2, or 4
 - ▶ Offset LO interface enables drive with $f_{RF} = f_{LO}$
 - ▶ Single-ended or differential drive
 - ▶ SYNC function—synchronization across multiple devices
- ▶ High dynamic range wideband IF signal path
 - ▶ SPI-programmable IF bandwidth from 1 MHz to 100 MHz
 - ▶ SPI-programmable IF gain, 6 dB step size
 - ▶ Externally adjustable output common-mode level
- ▶ 5-bit SPI readable temperature sensor
- ▶ Low power shutdown mode
- ▶ 3 mm × 4 mm, 26-lead LGA

APPLICATIONS

- ▶ Broadband, multiport vector network analyzers
- ▶ S-parameter magnitude and phase measurement
- ▶ Inline RF power measurement
- ▶ Automated test equipment
- ▶ Reflectometers
- ▶ Materials analysis

GENERAL DESCRIPTION

The ADL5960 is a wideband, small form factor vector network analyzer front end consisting of a resistive bidirectional bridge, downconversion mixers, programmable IF amplifiers and filters, and a highly flexible local oscillator (LO) interface. The bridge provides >14 dB of directivity up to 17 GHz. The primary transmission line from RFIN to RFOUT is wideband matched to 50 Ω with only 1.1 dB loss at low frequencies, increasing to 1.8 dB loss at 20 GHz.

The ADL5960 supports several different LO interface configurations that simplify the clocking design of a vector network analyzer (VNA) solution as well as the interfacing of the device to an analog-to-digital converter (ADC). The frequency divider and multipliers in the LO interface enable measurement sweeps beyond the operating frequency range of the LO source, enabling operation over the full 20 GHz frequency range of the ADL5960 using a 6 GHz synthesizer. The IF frequency offset mixer, driven through the offset interface formed by the OFP and OFM pins, enables further simplification by allowing the swept RF and LO interfaces to share the same

FUNCTIONAL BLOCK DIAGRAM

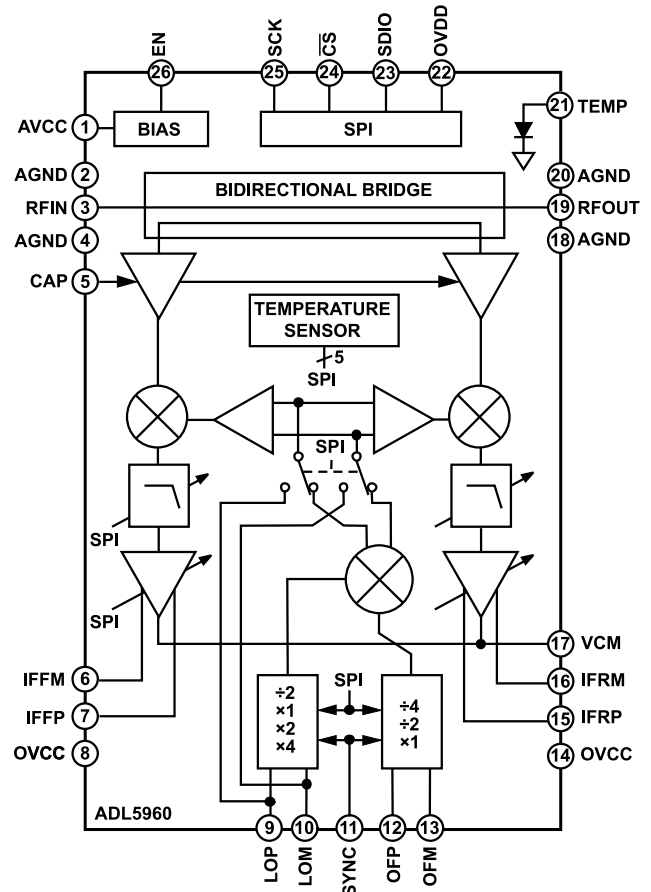

Figure 1. Functional Block Diagram

frequency source. The frequency of the IF output signals is then determined by the low-frequency source driving the OFP/OFM interface. When this interface is driven at the ADC sample frequency with the divide by 4 enabled, it automatically centers the IF output signal in the first Nyquist zone.

The IF filters with programmable bandwidth and IF amplifiers with individually programmable gain enable simultaneous dynamic range optimization of the IF output signals of the forward channel (IFFP, IFFM) and reverse channel (IFRP, IFRM). The IF amplifiers have an adjustable output common-mode level, sufficient drive capability, and wide output voltage swing to enable direct interfacing to a wide range of ADCs.

All configurations and functions in the ADL5960 are fully programmable through a 3-wire serial peripheral interface (SPI). The ADL5960 is offered in a 3 mm × 4 mm, 26-lead land grid array (LGA) package.

Rev. B

DOCUMENT FEEDBACK

TECHNICAL SUPPORT

Information furnished by Analog Devices is believed to be accurate and reliable "as is". However, no responsibility is assumed by Analog Devices for its use, nor for any infringements of patents or other rights of third parties that may result from its use. Specifications subject to change without notice. No license is granted by implication or otherwise under any patent or patent rights of Analog Devices. Trademarks and registered trademarks are the property of their respective owners.

TABLE OF CONTENTS

Features.....	1	Multiport Vector Network Analyzer.....	17
Applications.....	1	Calibration and Error Correction.....	19
Functional Block Diagram.....	1	Applications Information.....	23
General Description.....	1	Interface Descriptions.....	23
Specifications.....	3	LO Interface Configuration.....	25
Serial Interface Timing Specifications.....	5	IF Signal Path Configuration.....	26
Absolute Maximum Ratings.....	6	Serial Peripheral Interface.....	28
Thermal Resistance.....	6	Protocol.....	28
ESD Caution.....	6	Register Address.....	28
Pin Configuration and Function Descriptions.....	7	Read and Write Methods.....	28
Typical Performance Characteristics.....	8	Register Details.....	28
Theory of Operation.....	16	Typical Application Test Circuit.....	31
Basic One-Port Vector Network Analyzer.....	16	Outline Dimensions.....	32
Frequency Planning—LO Configurations.....	16	Ordering Guide.....	32
OF Interface.....	17	Evaluation Boards.....	32
IF Signal Path.....	17		

REVISION HISTORY**12/2024—Rev. A to Rev. B**

Changes to Table 5.....	7
Change to Power Supply Interfaces Section.....	23
Changes to Ordering Guide.....	32

7/2023—Rev. 0 to Rev. A

Changes to Ordering Guide.....	32
--------------------------------	----

7/2023—Revision 0: Initial Version

SPECIFICATIONS

AVCC = OVCC = 5.0 V, EN = OVDD = 3.3 V, VCM = 2.5 V, $T_A = 25^\circ\text{C}$, source and load impedance = 50 Ω , continuous wave (CW) input at RFIN, RF power (P_{RF}) = 0 dBm, LO drive single-ended, LO power (P_{LO}) = 0 dBm, RF frequency (f_{RF}) = 1 GHz, LO frequency (f_{LO}) = $f_{RF} + 500$ kHz, FGAIN (Register 0x23, Bits[6:0]) = RGAIN (Register 0x24, Bits[6:0]) = 24 (decimal), BYPASS (Register 0x20, Bit 4) = 1, default SPI register values, unless otherwise noted. Test circuit shown in [Figure 72](#).

Table 1. Specifications

Parameter	Test Conditions/Comments	Min	Typ	Max	Unit	
BIDIRECTIONAL BRIDGE						
RF Frequency Range	RFIN to RFOUT		0.01 to 20		GHz	
Insertion Loss	$f_{RF} = 10$ MHz		1.0		dB	
	$f_{RF} = 1$ GHz		1.1		dB	
	$f_{RF} = 10$ GHz		1.8		dB	
	$f_{RF} = 15$ GHz		1.8		dB	
	$f_{RF} = 18$ GHz		1.9		dB	
	$f_{RF} = 20$ GHz		1.8		dB	
Return Loss	$f_{RF} < 20$ GHz		>12		dB	
Directivity ¹	$f_{RF} = 10$ MHz, LOMODE = 0, BYPASS = 0		21.6		dB	
	$f_{RF} = 1$ GHz		24.1		dB	
	$f_{RF} = 10$ GHz		28.3		dB	
	$f_{RF} = 15$ GHz		20.7		dB	
	$f_{RF} = 18$ GHz		12.8		dB	
	$f_{RF} = 20$ GHz		8.9		dB	
Third-Order Intercept (IP3)	$f_{RF} = 1$ GHz		71		dBm	
VNA CHANNELS						
RF Frequency Range	RFIN to IFFP/IFFM, RFOUT to IFRP/IFRM		0.01 to 20		GHz	
RF to IF Leakage	$f_{RF} = 50$ MHz, differential IF output		-13.5		dBV	
Maximum Voltage Conversion Gain ²	FGAIN, RGAIN = 0x42 (66 dB)					
	$f_{RF} = 10$ MHz		41.1		dB	
	$f_{RF} = 1$ GHz		49.2		dB	
	$f_{RF} = 10$ GHz		48.0		dB	
	$f_{RF} = 15$ GHz		47.4		dB	
	$f_{RF} = 18$ GHz		46.4		dB	
Minimum Voltage Conversion Gain	$f_{RF} = 20$ GHz		45.2		dB	
	FGAIN, RGAIN = 0x00 (0 dB)					
	$f_{RF} = 10$ MHz		-21.4		dB	
	$f_{RF} = 1$ GHz	-15	-13.3	-11	dB	
	$f_{RF} = 10$ GHz		-14.5		dB	
	$f_{RF} = 15$ GHz		-15.2		dB	
Conversion Gain Step Size	$f_{RF} = 18$ GHz		-16.2		dB	
	$f_{RF} = 20$ GHz		-17.3		dB	
	See Table 11	4.4	6.0	6.3	dB	
	Input 1dB Compression Point (IP1dB)	$f_{RF} = 1$ GHz, FGAIN = RGAIN = 0		29		dBm
	Output 1dB Compression Point (OP1dB)	FGAIN, RGAIN ≥ 12 , 100 Ω differential load		18.4		dBm
	Input Third-Order Intercept (IIP3) ³	$f_{RF} = 1$ GHz, FGAIN, RGAIN = 0		32		dBm
Output Third-Order Intercept (OIP3)	FGAIN = RGAIN = 30 (decimal)		32.3		dBm	
Input Second-Order Intercept (IIP2) ³	$f_{RF} = 1$ GHz, FGAIN = RGAIN = 0		55		dBm	
Noise Figure	FGAIN = RGAIN = 60 (decimal)					
	$f_{RF} = 10$ MHz		73.5		dB	
	$f_{RF} = 1$ GHz		48.2		dB	
	$f_{RF} = 10$ GHz		48.1		dB	

SPECIFICATIONS

Table 1. Specifications (Continued)

Parameter	Test Conditions/Comments	Min	Typ	Max	Unit
	$f_{RF} = 15$ GHz		47.7		dB
	$f_{RF} = 18$ GHz		49.5		dB
	$f_{RF} = 20$ GHz		51.7		dB
LO INTERFACE	LOP, LOM				
Input Frequency Range	BYPASS = 1		0.01 to 20		GHz
	BYPASS = 0, LOMODE = 0 (divide by 2)		0.02 to 2.4		GHz
	BYPASS = 0, LOMODE = 1 (1 \times)		0.01 to 20		GHz
	BYPASS = 0, LOMODE = 2 (2 \times)		2 to 8		GHz
	BYPASS = 0, LOMODE = 3 (4 \times)		4 to 8		GHz
Return Loss	Characteristic impedance (Z_0) = 100 Ω differential		>10		dB
Input Power		-6	0	+6	dBm
LO to RF Leakage	BYPASS = 1, f_{LO}		-77.3		dBm
	BYPASS = 0, LOMODE = 0 (divide by 2), $f_{LO}/2$		-83.4		dBm
	BYPASS = 0, LOMODE = 0 (divide by 2), f_{LO}		-72.1		dBm
	BYPASS = 0, LOMODE = 1 (1 \times), f_{LO}		-80.4		dBm
	BYPASS = 0, LOMODE = 2 (2 \times), f_{LO}		-86.4		dBm
	BYPASS = 0, LOMODE = 2 (2 \times), $2f_{LO}$		-81.7		dBm
	BYPASS = 0, LOMODE = 3 (4 \times), f_{LO}		-93.4		dBm
	BYPASS = 0, LOMODE = 3 (4 \times), $2f_{LO}$		-102		dBm
	BYPASS = 0, LOMODE = 3 (4 \times), $4f_{LO}$		-92.1		dBm
LO to IF Leakage	$f_{RF} = 50$ MHz, differential		13.6		dBV
OFFSET FREQUENCY (OF) INTERFACE	OFF, OFM				
Input Frequency Range			0.1 to 400		MHz
OF Induced Spurious Tone at f_{IF}^4	OFMODE = 2 (divide by 4), $3f_{IF} = 1.5$ MHz		-3.2		dBc
	$5f_{IF} = 2.5$ MHz		-6.2		dBc
	$7f_{IF} = 3.5$ MHz		-8.7		dBc
Input Impedance	Differential		10 0.5		k Ω pF
Voltage Swing	Differential	0.125	0.5	2.0	V p-p
IF OUTPUT INTERFACE	IFFP/IFFM and IFRP/IFRM				
Output Frequency Range			0.1 to 100		MHz
Maximum Peak-to-Peak Voltage	Differential		8		V p-p
Short-Circuit Output Current	Single-ended, sourcing, output voltage = 0 V	200			mA
Output Noise Spectral Density	$f = f_{IF} = 500$ kHz, FGAIN = RGAIN = 60 (decimal), differential		207		μ V/ \sqrt Hz
VCM INTERFACE	VCM				
Input Voltage Range		1.0		4.0	V
Output V_{CM} Error	IF output common-mode voltage (V_{CM})	-100	0	+100	mV
Input Impedance			10k 4p		Ω F
ENABLE INTERFACE	EN				
Logic Low Input Voltage				0.8	V
Logic High Input Voltage		2.0			V
Current into pin				20	μ A
SPI AND SYNC INTERFACE	\overline{CS} , SCK, SDIO, SYNC				
Logic Low Input Voltage				$0.3 \times OVDD$	V
Logic High Input Voltage		$0.7 \times OVDD$			V
Input Voltage Hysteresis			209		mV
Current into Pin	\overline{CS} , SCK, SYNC			20	μ A
Logic Low Output Voltage	SDIO, sinking 10 mA			$0.3 \times OVDD$	V
Logic High Output Voltage	SDIO, sourcing 10 mA	$0.7 \times OVDD$			V

SPECIFICATIONS

Table 1. Specifications (Continued)

Parameter	Test Conditions/Comments	Min	Typ	Max	Unit
POWER SUPPLY INTERFACES					
Supply Voltage (AVCC, OVCC)	AVCC, OVCC, OVDD	4.75	5.0	5.25	V
Supply Current (AVCC + OVCC)	EN = AVCC, Register 0x20 = 0x0B (BYPASS = 0, LOMODE = 3)	200	225	250	mA
	EN = AVCC, Register 0x20 = 0x1D (OFMODE = 3)	110	120	130	mA
	EN = 0 V (shutdown)		32	2000	μA
SPI Supply Voltage (OVDD)		1.8	3.3	3.6	V
SPI Supply Current (OVDD)		2	24	500	μA

- 1 Error correction coefficient (ϵ_{00}) obtained from measurements of the ratio of reverse and forward IF output ports for short, open, and load terminations on RFOUT. Printed circuit board (PCB) transmission line is de-embedded by splitting the measured transmission matrix of the through line on the PCB in half and incorporating one half into the ideal model of the terminations. See the Calibration and Error Correction section for details.
- 2 Voltage gain from RF input to differential IF output, with high-impedance IF load. Although the FGAIN and RGAIN bit fields are seven bits wide, values beyond 0x42 are of limited practical use because amplified noise starts to saturate the IF output drivers.
- 3 Second RF tone power = 0 dBm, frequency = $f_{RF} + 100$ kHz.
- 4 Magnitude relative to the desired output at $f_{IF} = 500$ kHz.

SERIAL INTERFACE TIMING SPECIFICATIONS

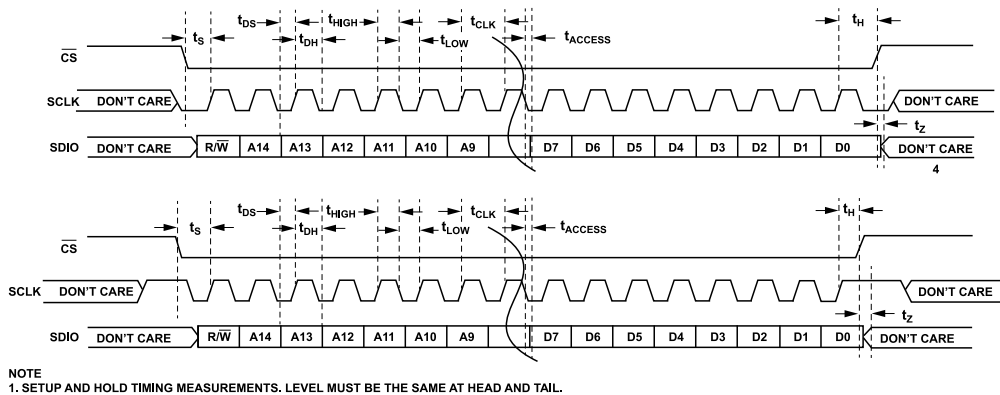

Figure 2. SPI Timing Diagram

Table 2. SPI Timing Specifications

Parameter	Description	Min	Typ	Max	Unit
t_{DS}	Setup time between data and rising edge of SCLK	15			ns
t_{DH}	Hold time between data and rising edge of SCLK	15			ns
t_{CLK}	Clock period	150			ns
t_S	Setup time between \overline{CS} and SCLK	40			ns
t_H	Hold time between \overline{CS} and SCLK	40			ns
t_{HIGH}	Minimum period that SCLK must be in a logic high state	75			ns
t_{LOW}	Minimum period that SCLK must be in a logic low state	75			ns
t_z	Maximum time delay between \overline{CS} deactivation and SDIO bus return to high impedance			150	ns
t_{ACCESS}	Maximum time delay between falling edge of SCLK and output data valid for a read operation			30	ns

ABSOLUTE MAXIMUM RATINGS

Table 3. Absolute Maximum Ratings

Parameter	Rating
Supply Voltage (AVCC and OVCC)	5.5 V
RFIN, RFOUT Input AC Power	
Average ¹	30 dBm
Peak ¹	35 dBm
DC Voltage	
RFIN, RFOUT to AGND ¹	-5 V to +10 V
OVDD	-0.3 V to +3.8 V
SCK, \overline{CS} , and SDIO	-0.3 V to OVDD + 0.3 V
IFFP, IFFM, IFRP, IFRM ²	-0.3 V to OVCC + 0.3 V
Any Other Pin ³	-0.3 V to AVCC + 0.3 V
DC Current RFIN to or from RFOUT	100 mA
Temperature	
Maximum T _J	150°C
T _A Operating Range	-40°C to +105°C
Storage Range	-65°C to +150°C

¹ Not production tested. Guaranteed by design and correlation to production tested parameters. Peak power duty cycle is 10% maximum.

² The voltage on these pins must not exceed 5.5 V, OVCC + 0.3 V, or be less than -0.3 V.

³ The voltage on these pins must not exceed 5.5 V, AVCC + 0.3 V, or be less than -0.3 V.

Stresses at or above those listed under Absolute Maximum Ratings may cause permanent damage to the product. This is a stress rating only; functional operation of the product at these or any other conditions above those indicated in the operational section of this specification is not implied. Operation beyond the maximum operating conditions for extended periods may affect product reliability.

THERMAL RESISTANCE

Thermal performance is directly linked to PCB design and operating environment. Careful attention to PCB thermal design is required.

θ_{JA} is the junction to ambient (or die to ambient) thermal resistance measured in a one cubic foot sealed enclosure, and θ_{JC} is the junction to case (or die to package) thermal resistance.

Table 4. Thermal Resistance

Package Type ¹	θ_{JA}	θ_{JB} ²	θ_{JCT} ³	θ_{JCB} ⁴	Ψ_{JT}	Ψ_{JB}	Unit
CC-26-2	39.32	13.10	30.09	7.63	1.30	12.95	°C/W

¹ Test Condition 1: thermal impedance simulated values are based upon use of 2S2P JEDEC PCB. See the [Ordering Guide](#).

² θ_{JB} is the junction-to-board thermal resistance.

³ θ_{JCT} is the junction-to-case top thermal resistance.

⁴ θ_{JCB} is the junction-to-case bottom thermal resistance.

ESD CAUTION



ESD (electrostatic discharge) sensitive device. Charged devices and circuit boards can discharge without detection. Although this product features patented or proprietary protection circuitry, damage may occur on devices subjected to high energy ESD. Therefore, proper ESD precautions should be taken to avoid performance degradation or loss of functionality.

PIN CONFIGURATION AND FUNCTION DESCRIPTIONS

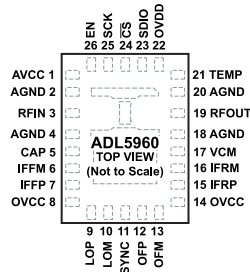

NOTES
 1. EXPOSED PAD. THE EXPOSED PAD (EPAD) ON THE UNDERSIDE OF THE DEVICE IS ALSO INTERNALLY CONNECTED TO GROUND AND REQUIRES GOOD THERMAL AND ELECTRICAL CONNECTION TO THE GROUND OF THE PRINTED CIRCUIT BOARD (PCB). CONNECT ALL GROUND PINS TO A LOW IMPEDANCE GROUND PLANE TOGETHER WITH THE EPAD.

Figure 3. Pin Configuration

Table 5. Pin Function Descriptions

Pin No.	Mnemonic	Description
1	AVCC	Analog Positive Power Supply Pin. Bypass by placing 1 nF and 4.7 μ F capacitors as closely as possible to the AVCC pin. On power-up, apply the AVCC voltage before the OVDD voltage. On power-down, remove the OVDD voltage before the AVCC voltage.
2, 4, 18, 20	AGND	Analog Ground Pins. All ground pins are internally connected. Use Pin 2 and Pin 4 as the RF return ground for the RFIN transmission line (Pin 3). Use Pin 18 and Pin 20 as the RF return ground for the RFOUT transmission line (Pin 19).
3, 19	RFIN, RFOUT	RF Input/Output of the Primary Transmission Line. RFIN and RFOUT have a 50 Ω load characteristic impedance and can DC-couple to a source and load. When using open and short terminations, do not exceed the maximum power dissipation ratings.
5	CAP	Bypass Capacitor. A 100 nF capacitor is recommended for 10 MHz operation.
6, 7, 15, 16	IFFM, IFFP, IFRP, IFRM	Differential IF Outputs. Pin 6 and Pin 7 are coupled to the forward power transfer (from RFIN to RFOUT). Pin 15 and Pin 16 are coupled to the reverse power transfer (from RFOUT to RFIN).
8, 14	OVCC	IF Amplifier Positive Power Supply Pin. Bypass OVCC with a 1 nF and a 4.7 μ F capacitor on each pin before connecting to AVCC. Place the capacitors as closely as possible to OVCC. On power-up, apply the OVCC voltage before the OVDD voltage. On power-down, remove the OVDD voltage before the OVCC voltage.
9, 10	LOP, LOM	Downconversion Mixer LO Inputs. LOP and LOM are internally terminated with a 100 Ω differential. A differential or single-ended signal source can drive the LOP and LOM pins. Register 0x20 configures the LO interface.
11	SYNC	Synchronization Input. This CMOS input pin stops the dividers in the LO and IF input interfaces when driven high and initiates synchronization when driven back low. If left floating, an internal 415 k Ω pull-down resistor disables the SYNC function.
12, 13	OFP, OFM	IF Offset Reference Frequency Inputs. The OFP and OFM pins set the center frequency at the IF outputs when the OFMODE bit field in Register 0x20 equals 0x0, 0x1, or 0x2. Setting OFMODE to 0x3 disables this input.
17	VCM	IF Output Common-Mode Voltage Control. The VCM pin sets the output common-mode voltage at IFFM, IFFP, IFRP, and IFRM. Floats to OVCC/2 if left open.
21	TEMP	Temperature Sensing Diode. The TEMP pin connects to the anode of an on-chip junction diode. TEMP can be used to measure the die temperature by measuring the voltage at this pin, while forcing a known current into the pin.
22	OVDD	SPI Positive Power Supply Pin. Connect this pin to the power supply of the SPI controller to avoid the need of voltage level translators in the SPI bus connections. On power-up, apply the AVCC and OVCC voltages before the OVDD voltage. On power-down, remove the OVDD voltage before the AVCC and OVCC voltages.
23	SDIO	SPI Data Input/Output. If the SDIO pin is floating, an internal 415 k Ω pull-down resistor pulls the pin to logic low.
24	\overline{CS}	SPI Chip Select (Active Low). If the \overline{CS} pin is floating, an internal 415 k Ω pull-up resistor ties the pin to OVDD.
25	SCK	SPI Clock Input. If SCK is left floating, an internal 415 k Ω pull-down resistor pulls the pin to logic low.
26	EN	Chip Enable. A logic high at the EN pin enables the chip. A logic low at the EN pin shuts down the ADL5960. If EN is left floating, an internal 415 k Ω pull-down resistor disables the ADL5960.
	EPAD	Exposed Pad. The exposed pad (EPAD) on the underside of the device is also internally connected to ground and requires good thermal and electrical connection to the ground of the PCB. Connect all ground pins to a low impedance ground plane together with the EPAD.

TYPICAL PERFORMANCE CHARACTERISTICS

AVCC = OVCC = 5.0 V, EN = OVDD = 3.3 V, VCM = 2.5 V, T_A = 25°C, 50 Ω source and load impedance, continuous wave input at RFIN, Z_O = 50 Ω, P_{RF} = 0 dBm, LO drive single-ended, P_{LO} = 0 dBm, f_{RF} = 1 GHz, and f_{LO} = f_{RF} + 500 kHz, unless otherwise noted. BYPASS = 1, FGAIN = RGAIN = 24, CIF1 = CIF2 = 15. Test circuit shown in Figure 72.

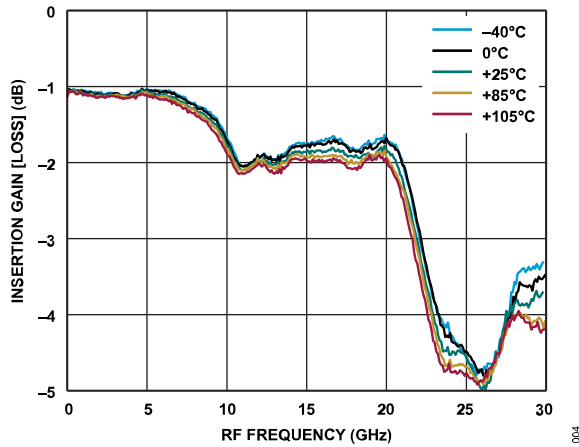

Figure 4. RFIN to RFOUT Insertion Gain (Loss) vs. RF Frequency at Various Temperatures

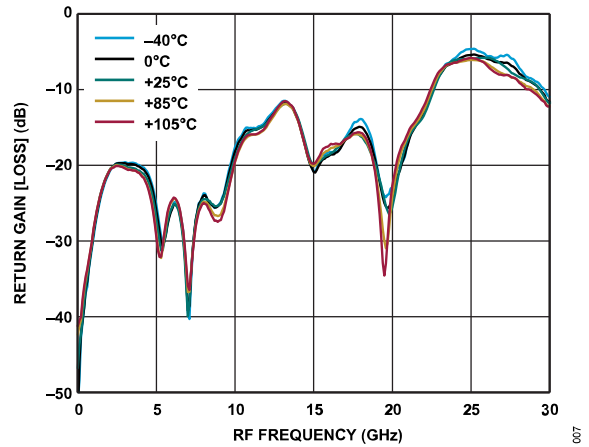

Figure 7. RFIN, RFOUT Return Gain (Loss) vs. RF Frequency at Various Temperatures

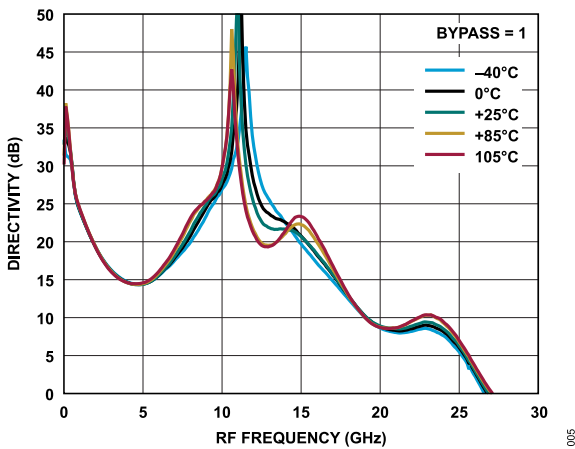

Figure 5. Directivity vs. RF Frequency at Various Temperatures, BYPASS = 1

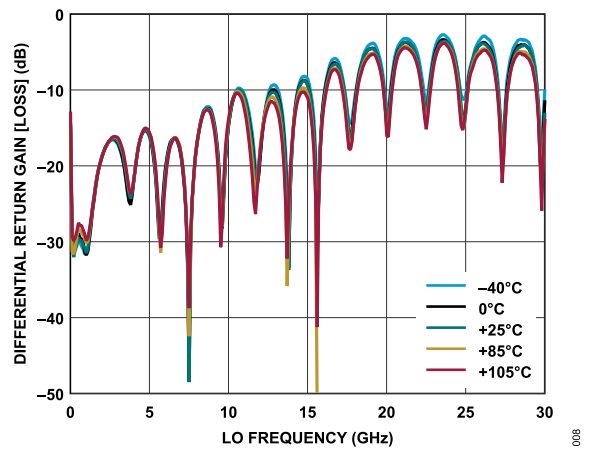

Figure 8. LO Differential Return Gain (Loss) vs. Frequency at Various Temperatures, Z₀ = 100 Ω

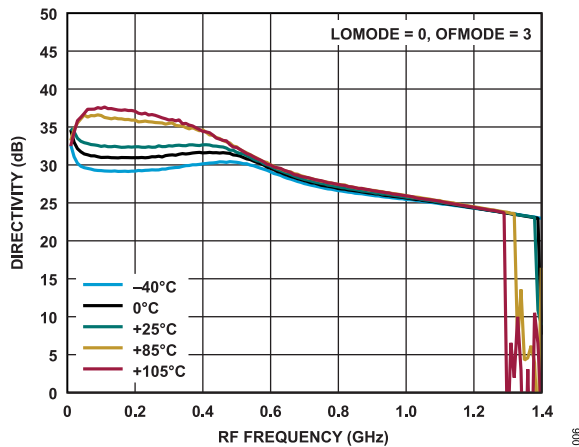

Figure 6. Directivity vs. RF Frequency at Various Temperatures, LOMODE = 0, OFMODE = 3

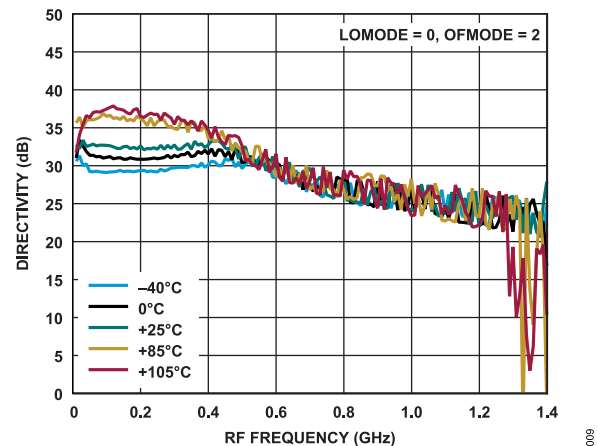

Figure 9. Directivity vs. RF Frequency at Various Temperatures, LOMODE = 0, OFMODE = 2

TYPICAL PERFORMANCE CHARACTERISTICS

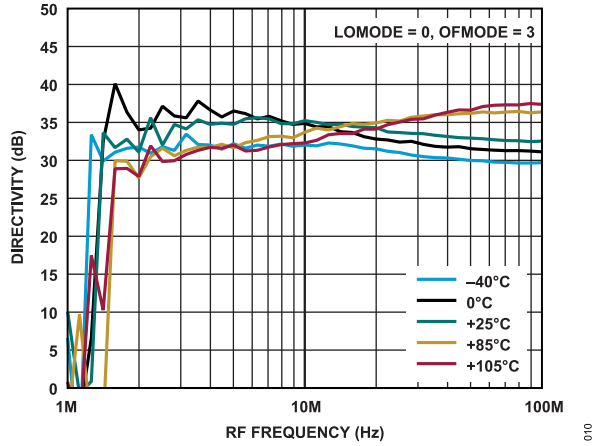

Figure 10. Directivity vs. Low RF Frequencies at Various Temperatures, LOMODE = 0, OFMODE = 3

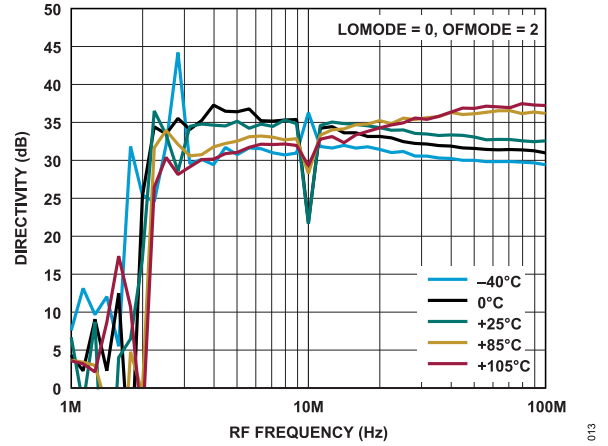

Figure 13. Directivity vs. Low RF Frequencies at Various Temperatures, LOMODE = 0, OFMODE = 2

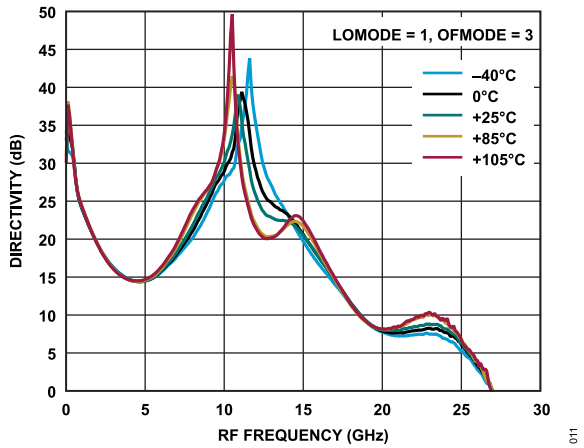

Figure 11. Directivity vs. RF Frequency at Various Temperatures, LOMODE = 1, OFMODE = 3

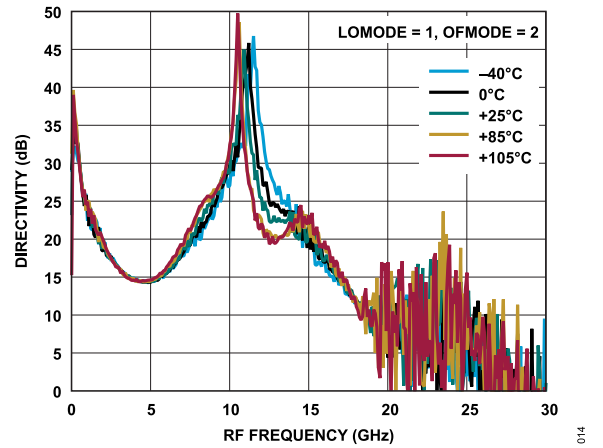

Figure 14. Directivity vs. RF Frequency at Various Temperatures, LOMODE = 1, OFMODE = 2

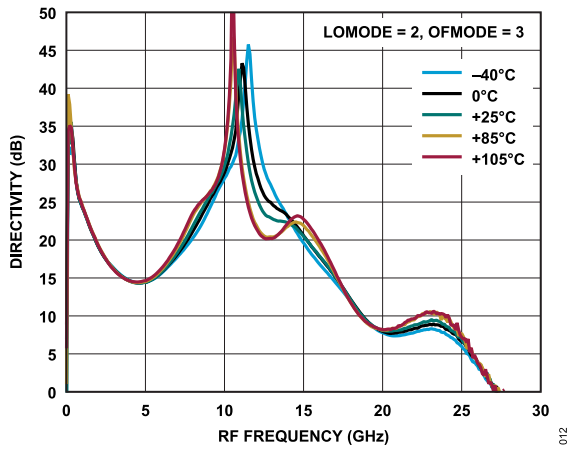

Figure 12. Directivity vs. RF Frequency at Various Temperatures, LOMODE = 2, OFMODE = 3

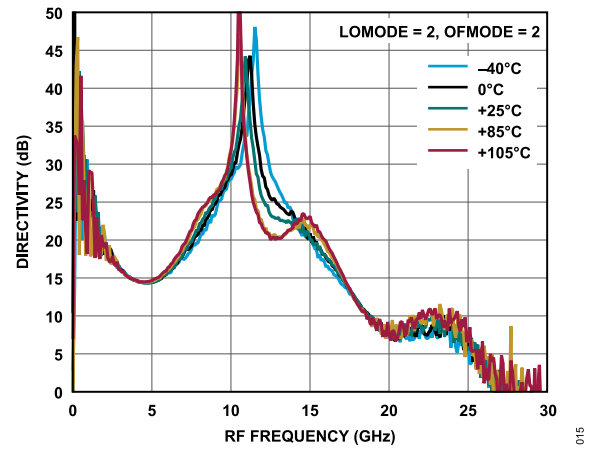

Figure 15. Directivity vs. RF Frequency at Various Temperatures, LOMODE = 2, OFMODE = 2

TYPICAL PERFORMANCE CHARACTERISTICS

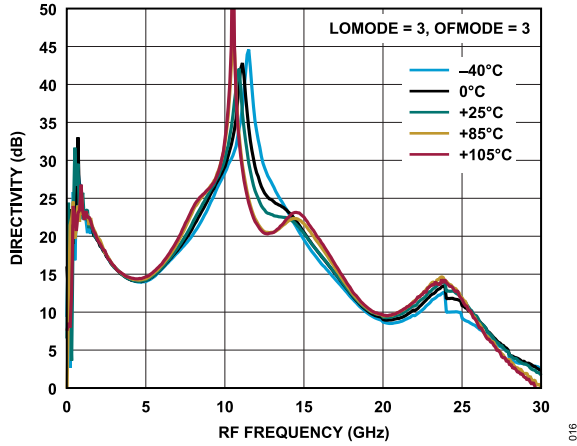

Figure 16. Directivity vs. RF Frequency at Various Temperatures, LOMODE = 3, OFMODE = 3

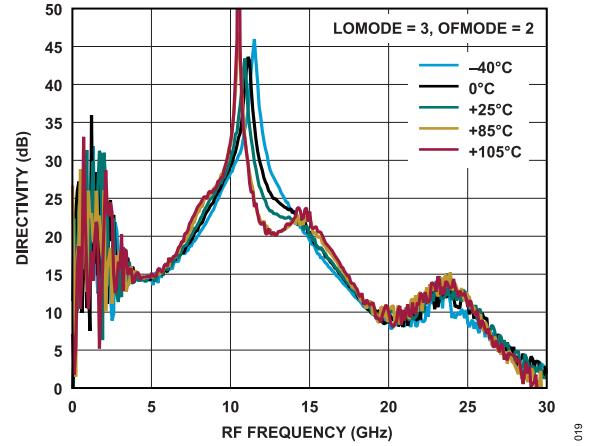

Figure 19. Directivity vs. RF Frequency at Various Temperatures, LOMODE = 3, OFMODE = 2

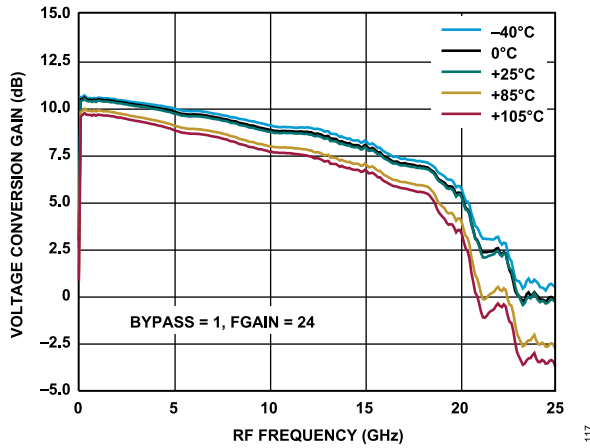

Figure 17. Voltage Conversion Gain vs. RF Frequency at Various Temperatures

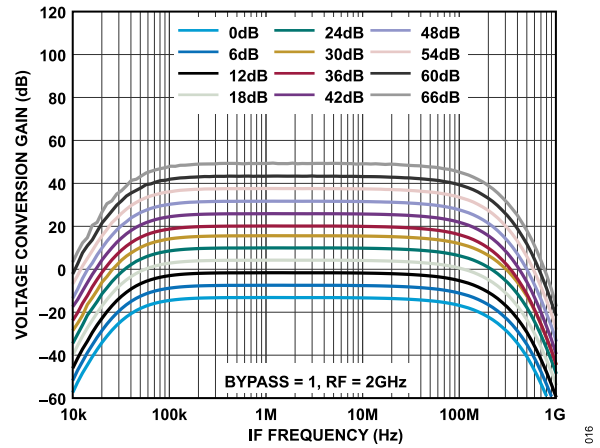

Figure 20. Voltage Conversion Gain vs. IF Frequency and FGAIN/RGAIN Settings

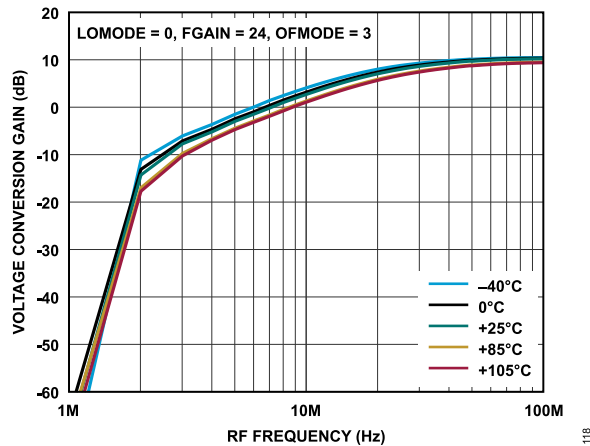

Figure 18. Voltage Conversion Gain at Low RF Frequencies at Various Temperatures, LOMODE = 0, OFMODE = 3

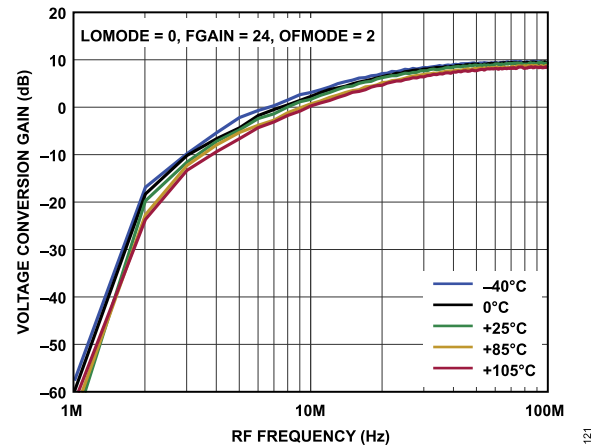

Figure 21. Voltage Conversion Gain at Low RF Frequencies at Various Temperatures, LOMODE = 0, OFMODE = 2

TYPICAL PERFORMANCE CHARACTERISTICS

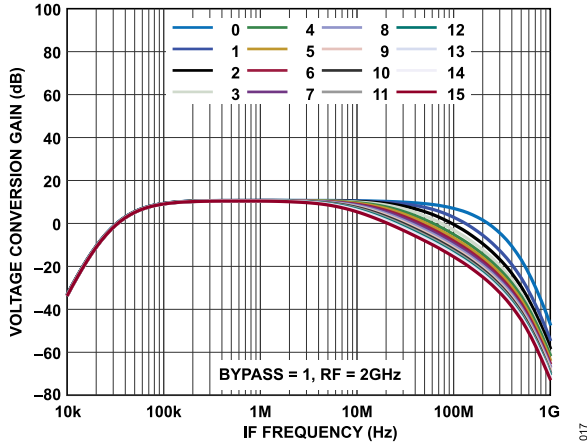

Figure 22. Voltage Conversion Gain vs. IF Frequency and CIF1 Setting, CIF2 = 0

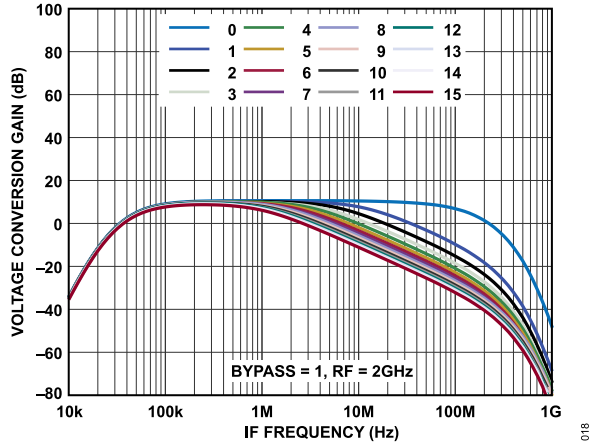

Figure 25. Voltage Conversion Gain vs. IF Frequency and CIF2 Setting, CIF1 = 0

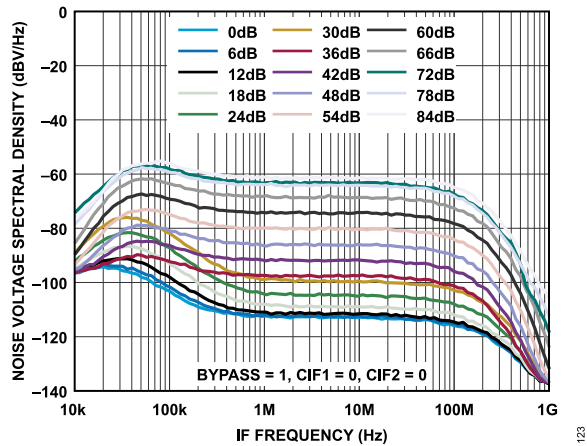

Figure 23. Differential IF Output-Noise Voltage Spectral Density vs. IF Frequency and Gain Settings (FGAIN, RGAIN), CIF1 = CIF2 = 0

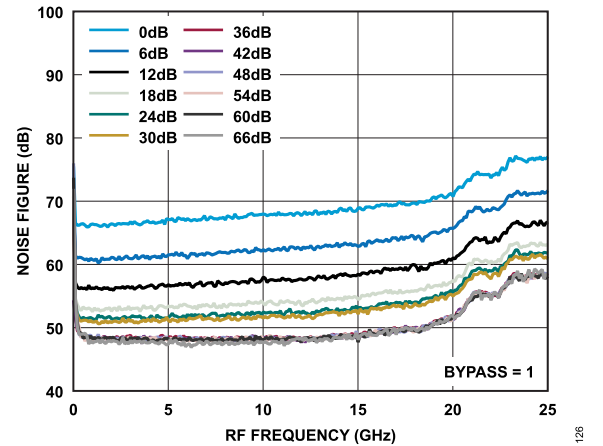

Figure 26. Noise Figure vs. RF Frequency and IF Gain Settings

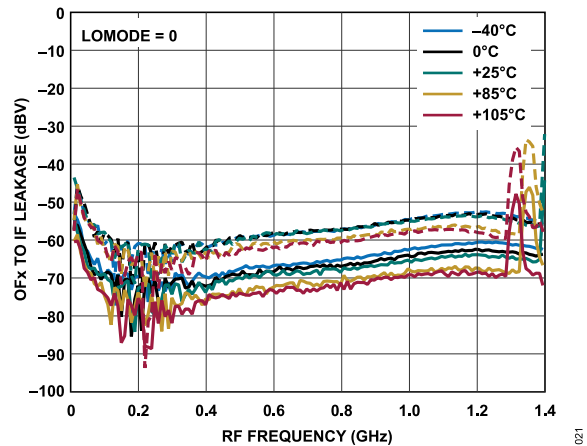

Figure 24. OFx to IF Leakage for Various Temperatures, LOMODE = 0, OFMODE = 2. Drawn: Forward Channel, Dashed: Reverse Channel

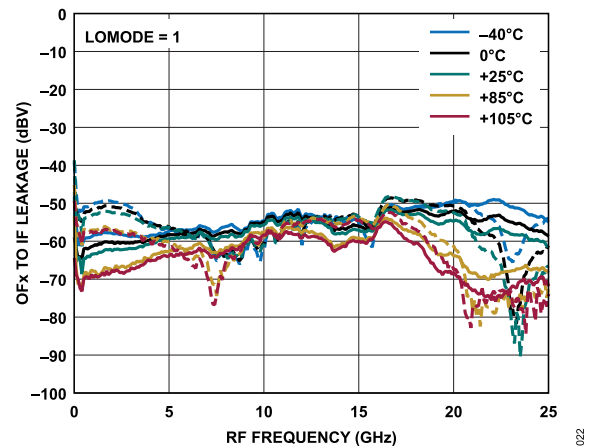

Figure 27. OFx to IF Leakage for Various Temperatures, LOMODE = 1, OFMODE = 2. Drawn: Forward Channel, Dashed: Reverse Channel

TYPICAL PERFORMANCE CHARACTERISTICS

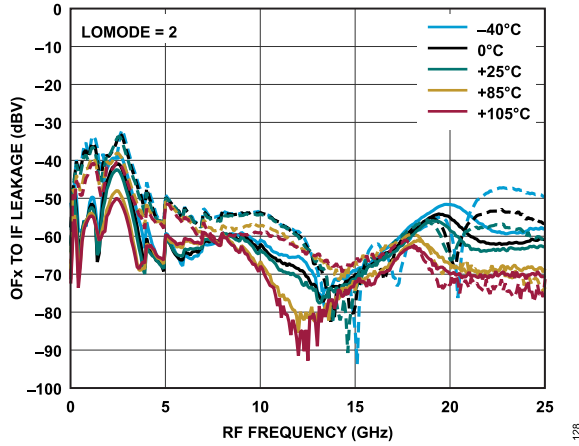

Figure 28. OFx to IF Leakage for Various Temperatures, LOMODE = 2, OFMODE = 2. Drawn: Forward Channel, Dashed: Reverse Channel

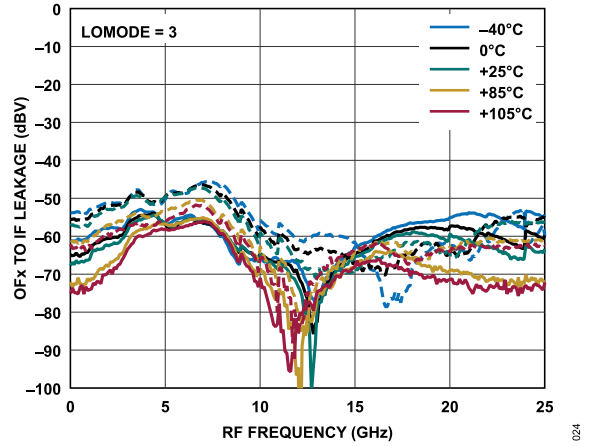

Figure 31. OFx to IF Leakage at Various Temperatures, LOMODE = 3, OFMODE = 2, Drawn: Forward Channel, Dashed: Reverse Channel

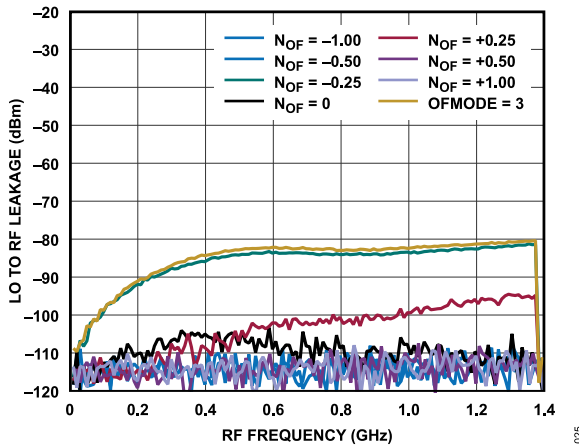

Figure 29. LO to RF Leakage for LOMODE = 0, Measurement Frequency = $f_{RF} + N_{OF} \times f_{OF}$ for OFMODE = 2, and $f_{RF} + f_{IF}$ for OFMODE = 3

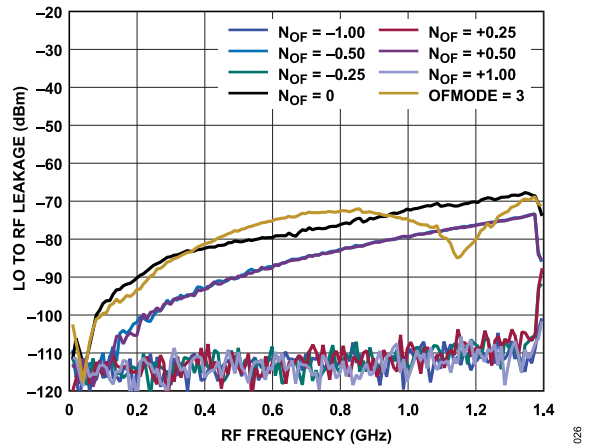

Figure 32. LO to RF Leakage for LOMODE = 0, Measurement Frequency = $2 \times f_{RF} + N_{OF} \times f_{OF}$ for OFMODE = 2, and $2 \times f_{RF} + f_{IF}$ for OFMODE = 3

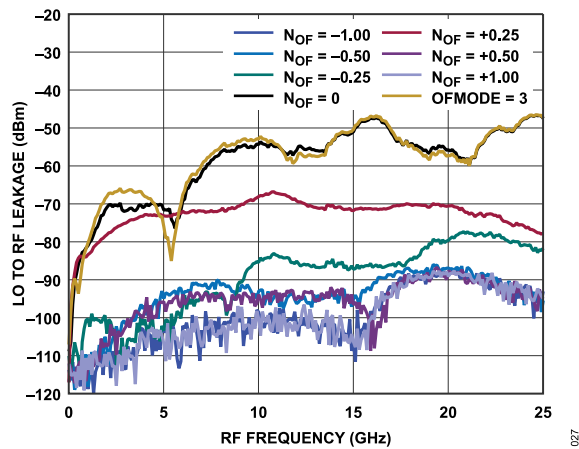

Figure 30. LO to RF Leakage for LOMODE = 1, Measurement Frequency = $f_{RF} + N_{OF} \times f_{OF}$ for OFMODE = 2, and $f_{RF} + f_{IF}$ for OFMODE = 3

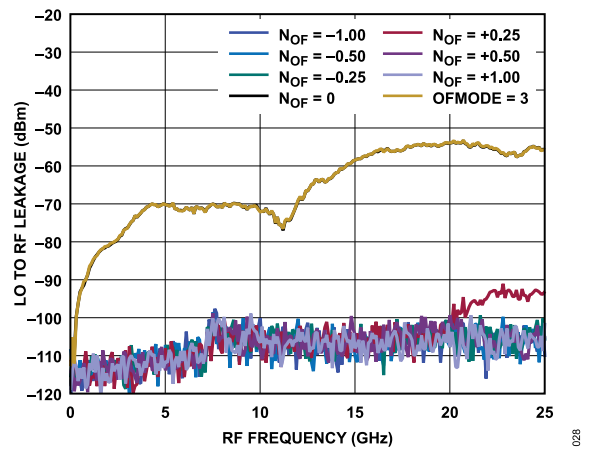

Figure 33. LO to RF Leakage for LOMODE = 2, Measurement Frequency = $f_{RF}/2 + N_{OF} \times f_{OF}$ for OFMODE = 2, and $f_{RF}/2 + f_{IF}$ for OFMODE = 3

TYPICAL PERFORMANCE CHARACTERISTICS

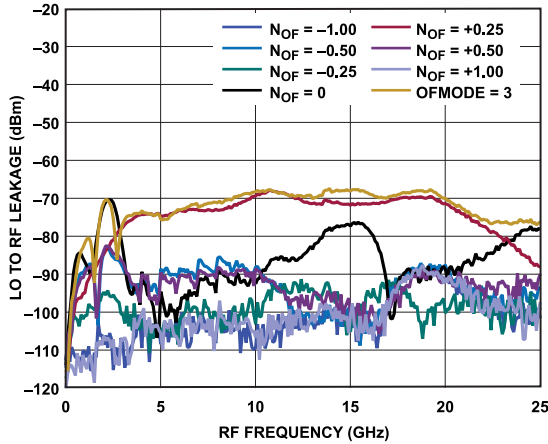

Figure 34. LO to RF Leakage for LOMODE = 2, Measurement Frequency = $f_{RF} + N_{OF} \times f_{OF}$ for OFMODE = 2, and $f_{RF} + f_{IF}$ for OFMODE = 3

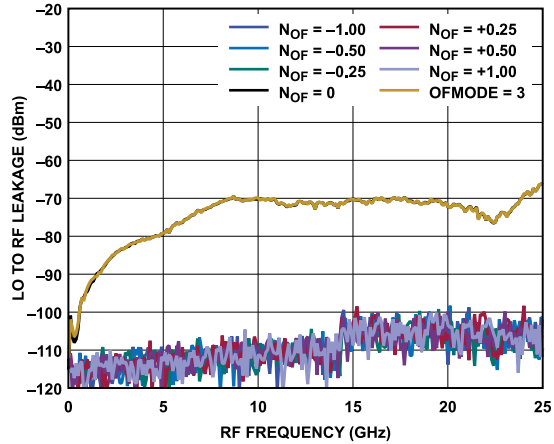

Figure 37. LO to RF Leakage for LOMODE = 3, Measurement Frequency = $f_{RF}/4 + N_{OF} \times f_{OF}$ for OFMODE = 2, and $f_{RF}/4 + f_{IF}$ for OFMODE = 3

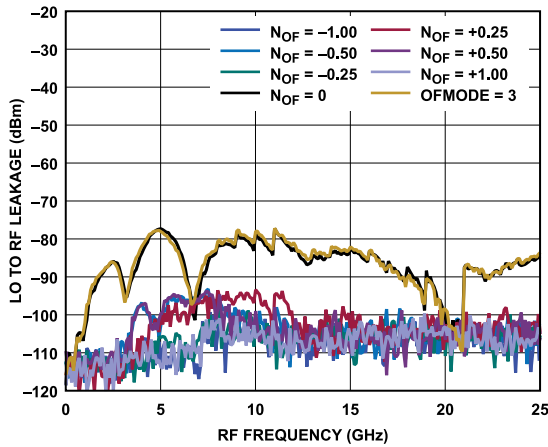

Figure 35. LO to RF Leakage for LOMODE = 3, Measurement Frequency = $f_{RF}/2 + N_{OF} \times f_{OF}$ for OFMODE = 2, and $f_{RF}/2 + f_{IF}$ for OFMODE = 3

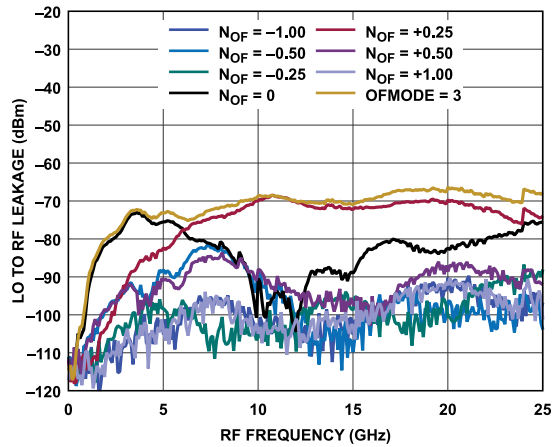

Figure 38. LO to RF Leakage for LOMODE = 3, Measurement Frequency = $f_{RF} + N_{OF} \times f_{OF}$ for OFMODE = 2, and $f_{RF} + f_{IF}$ for OFMODE = 3

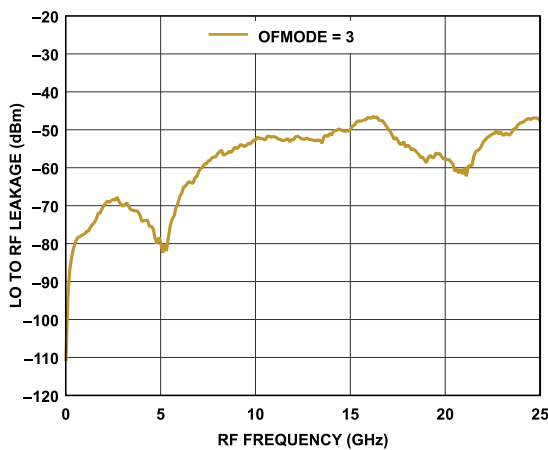

Figure 36. LO to RF Leakage for BYPASS = 1, Measurement Frequency = $f_{RF} + f_{IF}$

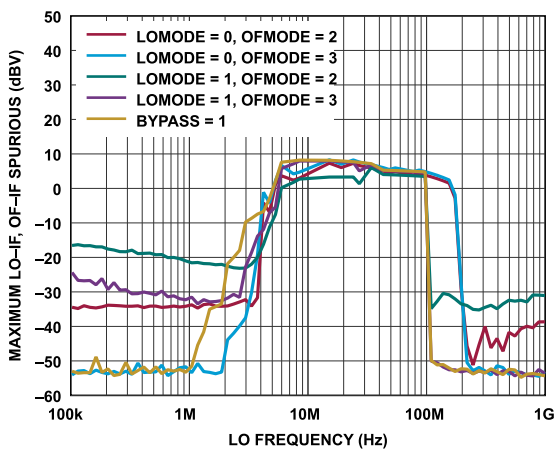

Figure 39. Maximum LO to IF, OF to IF Spurious Tone Levels vs. LO Frequency, CIF1 = CIF2 = 0

TYPICAL PERFORMANCE CHARACTERISTICS

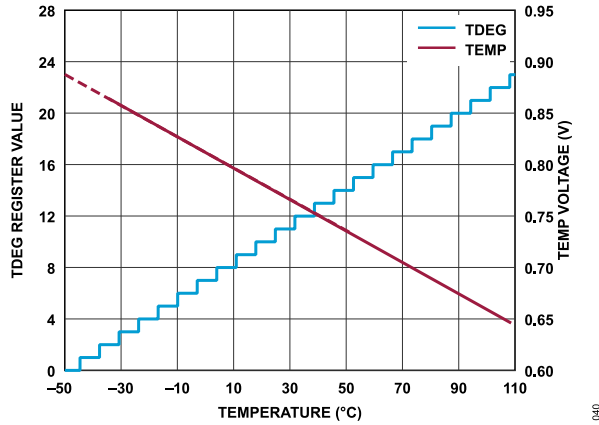

Figure 40. TDEG Register Value and TEMP Voltage vs. Temperature ($I_{TEMP} = 42 \mu A$)

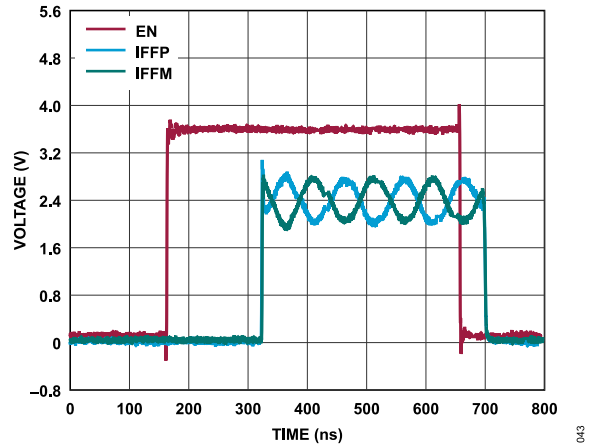

Figure 43. Turn-On/Off Time with Continuous Wave RF = 1 GHz, 10 dBm, IF = 10 MHz, 50 Ω Load at IFFP and IFFM

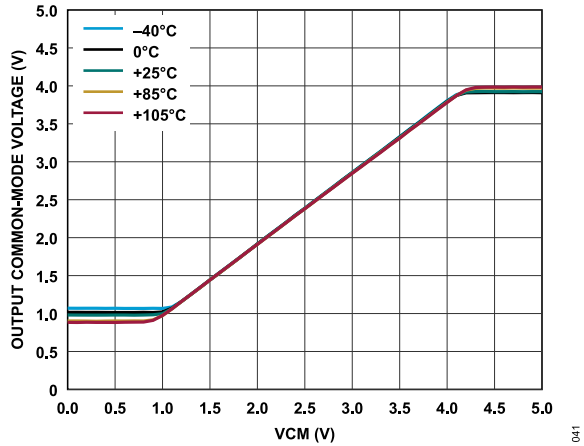

Figure 41. IF Output Common-Mode Voltage vs. Voltage at VCM Interface (VCM) at Various Temperatures

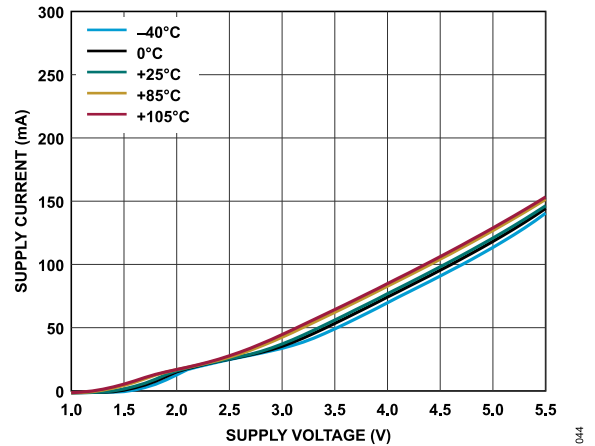

Figure 44. Supply Current vs. Supply Voltage at Various Temperatures, BYPASS = 1

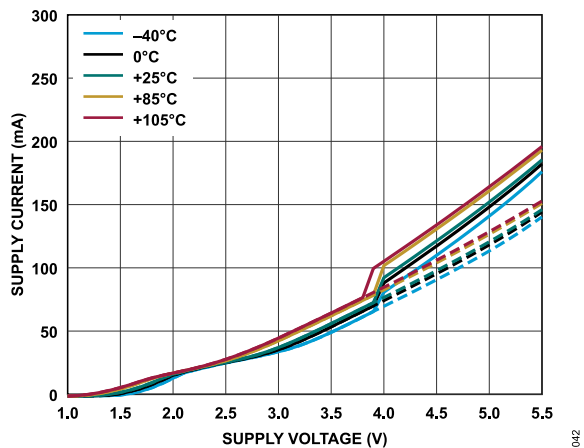

Figure 42. Supply Current vs. Supply Voltage at Various Temperatures, LOMODE = 0, Drawn: OFMODE = 2, Dashed: OFMODE = 3

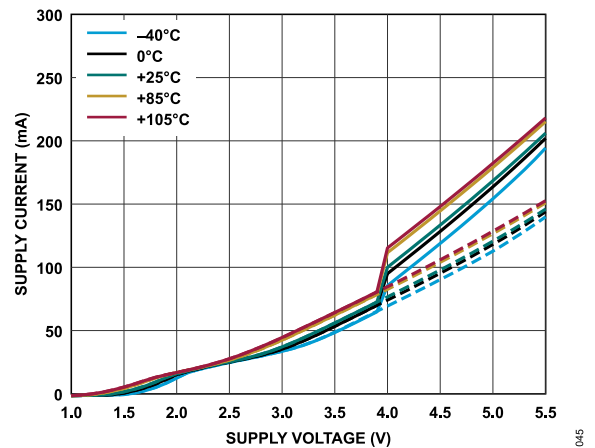

Figure 45. Supply Current vs. Supply Voltage at Various Temperatures, LOMODE = 1, Drawn: OFMODE = 2, Dashed: OFMODE = 3

TYPICAL PERFORMANCE CHARACTERISTICS

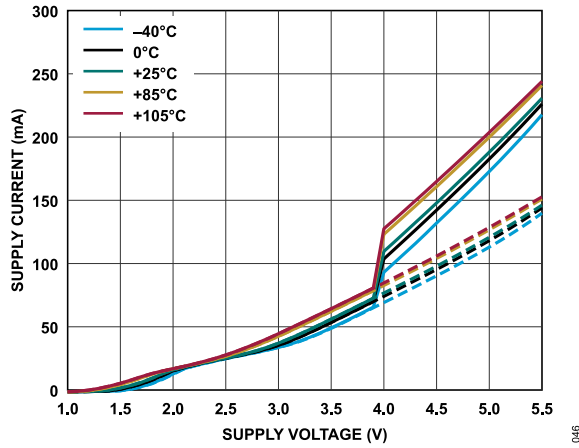

Figure 46. Supply Current vs. Supply Voltage at Various Temperatures, LOMODE = 2, Drawn: OFMODE = 2, Dashed: OFMODE = 3

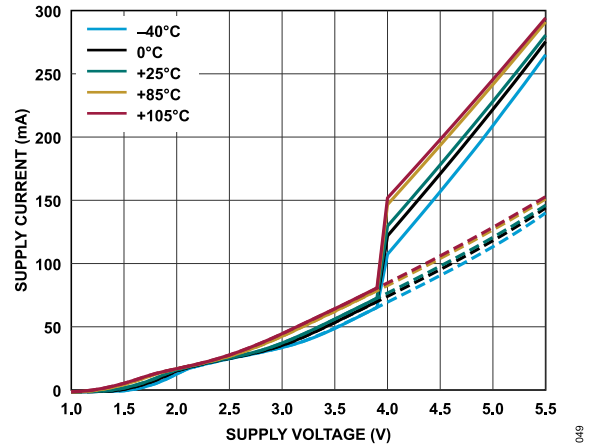

Figure 49. Supply Current vs. Supply Voltage at Various Temperatures, LOMODE = 3, Drawn: OFMODE = 2, Dashed: OFMODE = 3

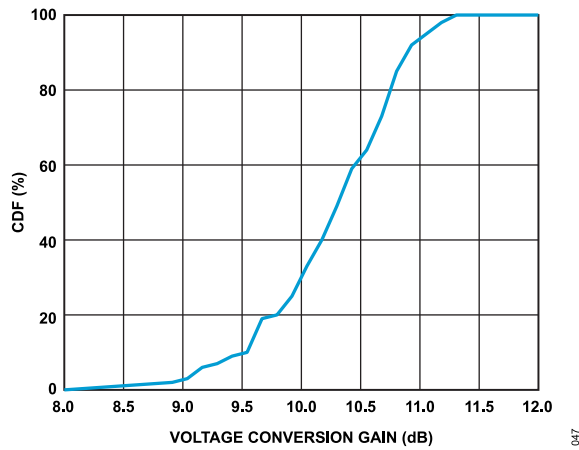

Figure 47. Conversion Gain Distribution, FGAIN = 24, Sample Size 100 Devices (CDF = Cumulative Distribution Function)

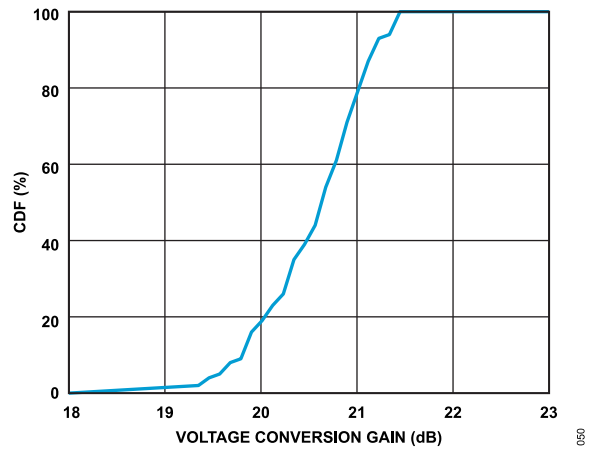

Figure 50. Conversion Gain Distribution, FGAIN = 36, Sample Size 100 Devices

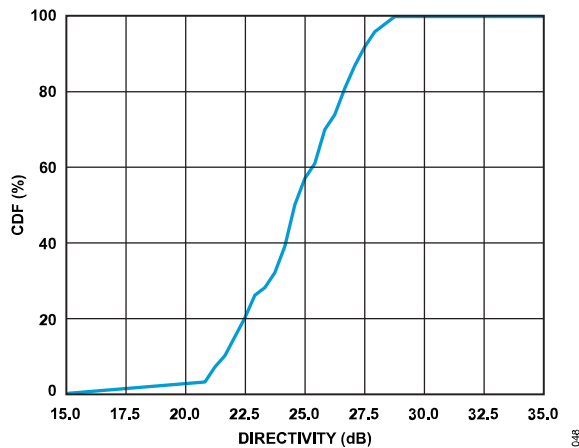

Figure 48. Directivity Distribution, RF = 1 GHz, Sample Size 100 Devices

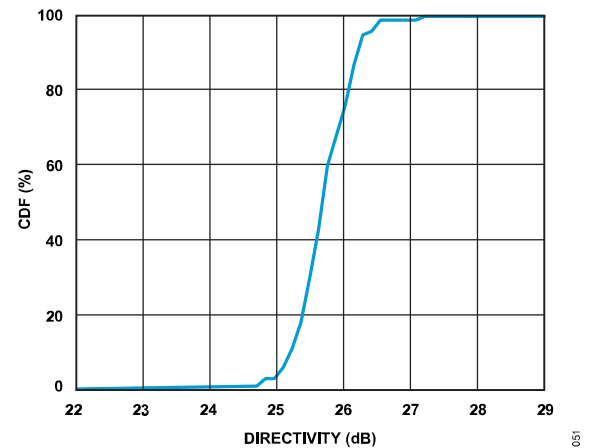

Figure 51. Directivity Distribution, RF = 10 GHz, Sample Size 100 Devices

THEORY OF OPERATION

The ADL5960 is designed to enable broadband multiport network analyzer solutions in a small footprint.

The ADL5960 is built around an integrated broadband bidirectional resistive bridge and coupled to broadband dual downconversion mixers. The differential IF outputs of the mixers are passed through low-pass filters with SPI-programmable bandwidth and IF amplifiers with individually SPI-programmable gain.

The LO interface to the mixers supports multiple SPI-programmable configurations, and is designed to simplify the frequency plan in a vector network analyzer application. The LO interface contains frequency multipliers and dividers that enable a wider frequency range of operation than supported by the LO signal source itself. A second input to the LO interface, the offset interface formed by the OFP and OFM pins, enables a zero-offset operating mode with greatly simplified frequency plan. In this mode, only a single swept high-frequency signal source is needed, driving both the RF and LO interfaces of the ADL5960. The signal supplied to the OF interface controls the frequency of the IF output signal as it mixes with the LO signal supplied to the LOP/LOM interface before driving the downconversion mixers.

Multiple ADL5960 devices can be phase synchronized and operated simultaneously, which enables the construction of small footprint multiport network analyzers using one ADL5960 device per network analyzer port.

BASIC ONE-PORT VECTOR NETWORK ANALYZER

A one-port vector network analyzer, or reflectometer, can be used to measure the magnitude and phase of the reflection coefficient of an unknown load vs. frequency.

Figure 52 shows the basic configuration of a one-port analyzer based on the ADL5960. The RFIN interface of the ADL5960 connects to the RF signal source (typically continuous wave), while the RFOUT interface connects to the unknown load, the device under test (DUT). Because the ADL5960 is completely symmetric, the RF source can also be connected to RFOUT and the load to RFIN. The RF source injects an incident RF signal into the directional bridge of the ADL5960, traveling from the source to the load. At the load, part of this incident power wave is reflected and travels back to the source, while the other part is absorbed by the load. The reflection coefficient to be measured (both magnitude and phase) equals the ratio of the reflected power to the incident power at the load. For proper operation of the bidirectional bridge, it is important that the RF signal source has a 50 Ω characteristic impedance. The LO interface can either be driven by a 50 Ω single-ended source or a 100 Ω differential source.

The directional bridge on the ADL5960 supplies a fraction of the incident signal to the input of the forward IF channel, and, likewise, a fraction of the reflected signal to the input of the reverse IF channel. Both these IF signals are downconverted, filtered, amplified, and made available at the differential IF channel output interfaces, IFFx

(with the IFFP and IFFM terminals) and IFRx (with the IFRP and IFRM terminals), respectively.

After analog-to-digital conversion, the IF output signals representing the incident and reflected waves are digitally quadrature (complex) downconverted, filtered, and decimated. Finally, their ratio (reflected/forward) is calculated to obtain the (complex) reflection coefficient.

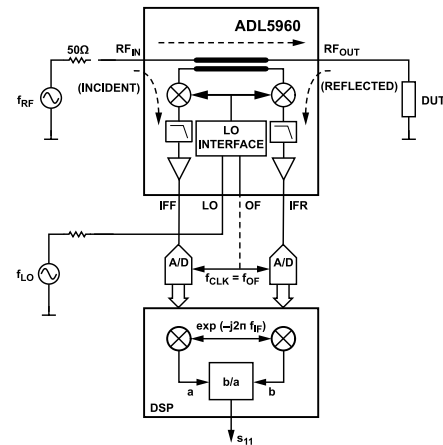

Figure 52. ADL5960 Used as One-Port VNA (Reflectometer)

FREQUENCY PLANNING—LO CONFIGURATIONS

The LO interface of the ADL5960 supports several different configurations, some of which significantly simplify the VNA configuration in exchange for slightly degraded accuracy.

The bypass mode, selected by setting Bit 4 in Register 0x20, is the most basic and highest performance mode of operation of the ADL5960. In this mode, the LO signal supplied to the LO interface (that is, the LOP and LOM pins) directly drives the downconversion mixers, bypassing the frequency multipliers, dividers, and offset mixer. To maintain a fixed IF output frequency, the LO signal must maintain a fixed frequency offset relative to the RF signal across the entire frequency sweep.

$$f_{LO} = f_{RF} \pm f_{IF} \quad (1)$$

The + sign corresponds to high-side injection, and the - sign corresponds to low-side injection. High-side injection often results in slightly improved dynamic range, because more of the mixing products calculate out at higher frequencies than the desired IF signal and can be suppressed by low-pass filtering. The ADL5960 supports IF frequencies up to 100 MHz. For high dynamic range analog-to-digital conversion, an IF frequency of a few MHz is often preferable, but an IF of 2 MHz to 3 MHz creates challenges for the signal sources, requiring an accurate, small frequency offset of a few MHz between RF and LO up to 20 GHz signal frequencies.

The frequency divider and frequency multipliers integrated into the LO interface of the ADL5960 enable measurement sweeps beyond the frequency range supported by the LO source itself, typically

THEORY OF OPERATION

a frequency synthesizer. When Bit 4 in Register 0x20 is cleared (disabling bypass mode), the LOMODE bit field in Bits[1:0] can be used to program the LO multiplication factor, M_{LO} as seen in the following equation:

$$M_{LO} = 2^{LOMODE - 1} \quad (2)$$

That is, divide by 2, or multiply by 1, 2, or 4. To ensure that the desired output signal downconverts at the desired IF output frequency, f_{IF} , the frequency supplied to the LO interface must meet the following condition:

$$f_{LO} = (f_{RF} \pm f_{IF}) / M_{LO} \quad (3)$$

Note from [Table 1](#) that the divide-by-two mode can only be used for LO input frequencies up to 2.4 GHz, whereas the doubler and quadrupler modes only operate from 2 GHz to 8 GHz and from 4 GHz to 8 GHz, respectively. The LO interface also contains high-frequency filters that suppress the harmonics and subharmonics in the multiplier outputs. The center frequency of these filters can be programmed through Register 0x21 and Register 0x22.

OF INTERFACE

Further simplification of the VNA configuration can be achieved by employing the differential offset frequency (OF) interface. In this configuration, a single swept source can be used to drive the RF and LO interfaces at the same frequency (zero frequency offset), while the IF output frequency is set by the signal applied to the OF interface. To enable the offset mixer, clear Bit 4 in Register 0x20 and program the OFMODE bit field in Bits[3:2]. The offset frequency input interface, when enabled, contains a programmable divider with ratios of 1, 2, and 4. The multiplication factor, M_{OF} , is as shown in [Table 6](#).

Table 6. Offset Input Configuration

Register 0x20 [3:2] OFMODE	Divide by	M_{OF}
00	1	1
01	2	0.5
10 (default)	4	0.25
11	Dividers off	Not applicable

The IF output signal frequency, including the offset mixer, can be represented as follows:

$$f_{IF} = f_{RF} - M_{LO} \times f_{LO} + M_{OF} \times f_{OF} \quad (4)$$

For a true zero-offset sweep the LO frequency therefore needs to satisfy the following:

$$f_{LO} = f_{RF} / M_{LO} \quad (5)$$

such that the first two terms of [Equation 4](#) cancel out, and the IF output frequency equals the following:

$$f_{IF} = M_{OF} \times f_{OF} \quad (6)$$

The setting $M_{OF} = 1/4$ (OFMODE = 2) is particularly useful and is the recommended OFMODE setting. When the OF interface is driven by the ADC sample clock frequency, f_s , it precisely centers the IF output signal in the first Nyquist zone of the ADC, with four time domain sample points per complete cycle of IF waveform. In this mode, the discrete time nature of the IF waveform becomes evident due to the divide-by-4 digital dividing of the offset input.

IF SIGNAL PATH

The IF output signal of the mixers is passed through low-pass filters to remove unwanted mixing products and noise. The bandwidth of these filters is SPI-programmable through Register 0x25. The same bandwidth setting is applied to both ADL5960 IF channels.

The IF amplifiers that follow the low-pass filters have individually SPI-programmable gain, adjustable in 6 dB steps. This programmable gain enables optimal interfacing of both channels to the ADC input dynamic range.

The IF output interfaces of the ADL5960 are suited to drive a wide range of ADCs directly. To avoid aliasing of broadband noise, it is recommended to insert a simple antialiasing filter as shown in [Figure 53](#).

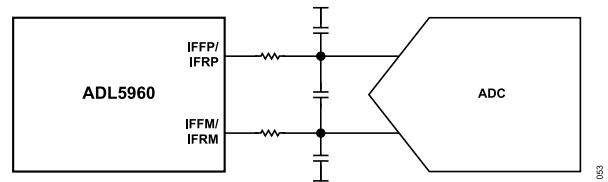

Figure 53. Interfacing the ADL5960 to an ADC

Each of the differential IF output nodes are low source impedance. For this reason, it is recommended to use series resistors when necessary, such as for driving filters or highly capacitive loads or cables, as shown on [the test circuit](#).

MULTIPOINT VECTOR NETWORK ANALYZER

The ADL5960 can also be used to create network analyzers consisting of multiple ports, as shown in [Figure 54](#). Each port connects to one ADL5960 device, and RF switches route the RF signal to one ADL5960 at a time. For optimum phase (and magnitude) accuracy, ensure the connections from the RF source to all ports are equal in length. Further, terminate the RFIN ports of the ADL5960 devices with 50 Ω at all times, that is, when the RF source is connected but also when the source is not connected to the port. A suitable way to achieve this is by using an SPxT nonreflective switch with the RF source connected to the pole. For VNAs with many ports, a cascade of nonreflective (terminated) RF switches can be used at the expense of larger insertion loss and potentially increased frequency tilt. Note that the connections to the RF source as drawn in [Figure 54](#) are overly simplified, and do not by any means follow the recommendations for an optimal layout of the system.

THEORY OF OPERATION

Phase synchronization between the ADL5960 devices is achieved through the LO and offset frequency signals. For optimal accuracy, it is preferable to match the propagation delays from the LO source to each of the ADL5960 devices. Residual delay differences can be addressed through calibration procedures for the VNA system. Routing of the signal lines to the offset interface is less critical, because these operate at much lower frequencies.

The SYNC interface is used to force the LO and offset dividers in all ADL5960 devices to the same known initial state, such that no phase ambiguities exist between the devices. A single pulse applied to this input after power-on is sufficient to synchronize all devices. Perform this synchronization before an LO signal is applied. In that case the timing of the SYNC pulse is not critical.

For the optimal accuracy, simultaneous sampling of all ADL5960 IF channels is recommended. For high port counts, a multichannel simultaneous sampling ADC can significantly reduce the solution footprint. Some of these multichannel devices include built-in digital downconversion (DDC) and decimation filters, which reduce the amount of processing required in the digital signal processor (DSP).

The performance of the system can further be enhanced by inserting a programmable RF filter in the RF path to filter any harmonic content of the RF source, and a programmable attenuator to compensate for tilt vs. frequency introduced by filters, switches, and transmission lines.

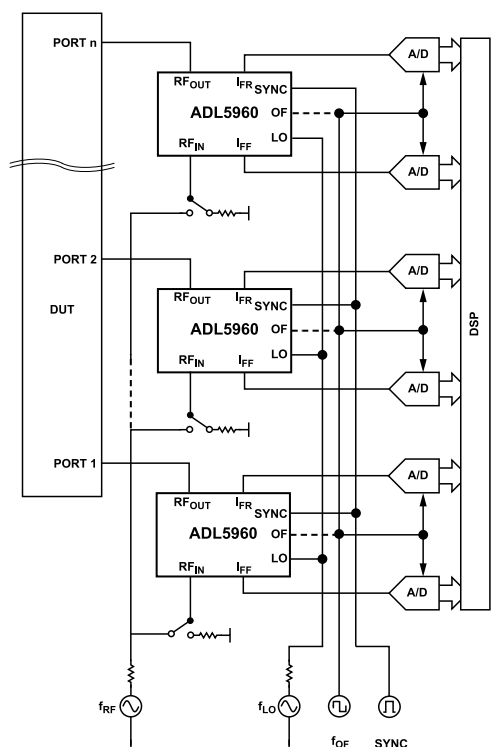

Figure 54. Multiport Vector Network Analyzer Based on the ADL5960

THEORY OF OPERATION

CALIBRATION AND ERROR CORRECTION

The accuracy of S-parameter measurements is prone to a variety of errors introduced by the hardware in vector network analyzers. Systematic errors, those that are repeatable and predictable, can be eliminated from the measurement results using calibration and error correction techniques. The types of systematic errors that can be eliminated (to a certain extent) include the following:

- ▶ Impedance mismatches
- ▶ Gain and insertion loss differences between channels
- ▶ Crosstalk between channels

Various error correction and calibration techniques have been developed over the years (see, for example, *D. K. Rytting, "Network Analyzer Accuracy Overview," 58th ARFTG Conference Digest, 2001, pp. 1-13, doi: 10.1109/ARFTG.2001.327486*) that differ in their effectiveness to eliminate certain errors, complexity, and calibration standards used. The general principals that are applied, however, are the same for all. The systematic errors are determined by measuring the VNA response for a set of DUTs with accurately known S-parameters—the calibration standards. Comparing the measured S-parameters with the known S-parameters allows calculation of the error coefficients. These error coefficients, combined into what is often referred to as an error adapter, can then be used in a postprocessing step to calculate the error corrected S-parameters from the measured S-parameters of an unknown DUT. [Figure 55](#) illustrates the concept.

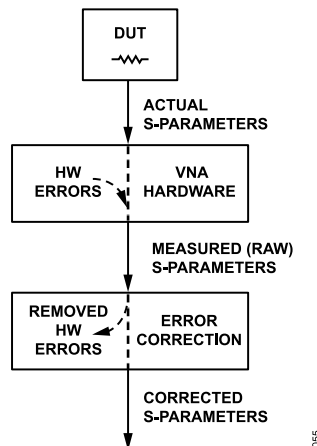

Figure 55. Concept of Error Correction in VNAs

Different error correction techniques require the use of different sets of calibration standards. Some of the most well known include short, open, load, thru (SOLT), thru, reflect, line (TRL), and thru, reflect, match (TRM). The standards within a set are chosen to have significantly different S-parameters, such that they span a large area on the Smith chart. The calibration standards themselves, particularly the ones with extreme S-parameter values such as short and open standards, are typically not completely ideal either and usually include a manufacturer supplied model for the S-parameters

vs. frequency. In general, calibration standards can be subdivided into the two following categories:

- ▶ One-port calibration standards, measured at each VNA port
- ▶ Two-port calibration standards, measured for each combination of VNA ports

The calibration procedure for a VNA built from ADL5960 devices is similar to that for any other VNA system. For maximum accuracy, it is important to note that the frequencies used. Additionally, the ADL5960 SPI gain, bandwidth, and frequency multiplier/divider settings used during calibration must exactly match the settings used during an actual DUT measurement. Calibrate the VNA for multiple different configurations if the settings are expected to be different during an actual measurement because gain and other settings are subject to device-to-device and channel-to-channel spread (mismatch).

Although S-parameters are the result of a power ratio calculation and, in principle, independent of absolute power levels, it is often important to accurately control the RF source power vs. frequency during a measurement. When the DUT exhibits nonlinearity across the applied RF power levels, such as semiconductor devices, a change in power level can result in a change of the DUT behavior that affects the measurement accuracy. The ADL5960 forward IF channel can be used to monitor the power levels in the RF signal path, particularly when the port is terminated with 50 Ω , such as during calibration of the system with a load standard. The conversion gain of the ADL5960 itself does exhibit roll-off vs. frequency as well, which must be taken into account to achieve an accurate power measurement.

One-Port Calibration

The calibration procedure for a one-port S-parameter measurement can be explained using the flow diagram in [Figure 56](#) (see also *D. K. Rytting, "Network Analyzer Accuracy Overview," 58th ARFTG Conference Digest, 2001, pp. 1-13, doi: 10.1109/ARFTG.2001.327486*). The directional coupler and error model together describe the operation of a practical VNA. The incident wave, a_0 , and reflected wave, b_0 , represent the forward and reverse power measured by the VNA. When using the ADL5960, these vectors are obtained from the IF outputs, IFFx and IFRx. The actual power incident on the load is represented by a_1 , whereas b_1 represents the actual power reflected by the load. An error-free VNA measures a_1 and b_1 .

THEORY OF OPERATION

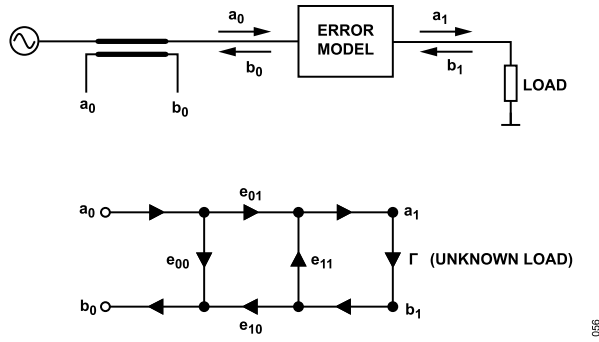

Figure 56. Error Model for One-Port S-Parameter Measurements

The flow diagram provides a more detailed description of the various error contributions that cause the measured reflection coefficient, $\Gamma_M = b_0/a_0$, to differ from the actual reflection coefficient, $\Gamma = b_1/a_1$. The factor, e_{11} , represents impedance mismatch of the VNA port (from 50 Ω). A fraction of b_1 is reflected back to the load. The e_{01} and e_{10} factors represent the tracking error. In relation to the ADL5960, the tracking error comprises insertion loss of the bridge, the conversion gain from RFIN to IFFx and RFOU to IFRx, as well as the mismatch in conversion gain between the channels. Finally, e_{00} represents the finite directivity of a practical VNA, a measure for the ability to separate the forward and reverse traveling power waves. If the load is a perfect 50 Ω , then $b_1 = 0$ and an ideal VNA measures $b_0 = 0$. However, in a practical VNA, the directivity is finite and some signal leaks from the forward path to the reverse path.

Using Figure 56, the measured reflection coefficient can be expressed in terms of the error coefficients and the reflection coefficient of the load as follows:

$$\Gamma_M = e_{00} + \frac{e_{01}e_{10}}{1 - \Gamma e_{11}} \Gamma \tag{7}$$

Equation 7 can be rearranged into a linear expression for the error coefficients as follows:

$$\begin{aligned} e_{00} - \Delta_e \Gamma + e_{11} \Gamma_M &= \Gamma_M \\ \Delta_e &= e_{00}e_{11} - e_{01}e_{10} \end{aligned} \tag{8}$$

A calibration procedure that measures three different known loads, that is, collects three combinations of measured and actual reflection coefficients, can then be used to calculate the error coefficients as follows:

$$\begin{bmatrix} 1 - \Gamma_1 & \Gamma_{M1} \\ 1 - \Gamma_2 & \Gamma_{M2} \\ 1 - \Gamma_3 & \Gamma_{M3} \end{bmatrix} \begin{bmatrix} e_{00} \\ \Delta_e \\ e_{11} \end{bmatrix} = \begin{bmatrix} \Gamma_{M1} \\ \Gamma_{M2} \\ \Gamma_{M3} \end{bmatrix} \Rightarrow \vec{e} = T^{-1} \vec{\Gamma}_M \tag{9}$$

After the system is calibrated, the corrected reflection coefficient can be calculated from the measured coefficient by rearranging Equation 7:

$$\Gamma = \frac{\Gamma_M - e_{00}}{e_{11}\Gamma_M - \Delta_e} \tag{10}$$

Although in principle any combination of sufficiently different standards can be used to calibrate the system, a combination of a short, an open, and a 50 Ω load are by far the most common choice. Note that the procedure outlined in Equation 9 needs to be repeated at every frequency point of interest.

Two-Port Calibration

The calibration procedure for a two-port S-parameter measurement can be explained using Figure 57. The VNA is modeled by Port 0, Port 2, and the error model. As a result of the hardware errors in the system, the measured S-parameters at Port 0 differ from the actual DUT S-parameters observed at Port 1, and the S-parameters measured at Port 2 differ from the DUT S-parameters at Port 3. As long as the error contributions scale linearly with power, the incident and reflected waves at Port 0 and Port 2 can be related to those at Port 1 and Port 3 using a block matrix, as follows:

$$\begin{bmatrix} b_0 \\ a_0 \\ b_2 \\ a_2 \end{bmatrix} = \begin{bmatrix} T_{01} & T_{03} \\ T_{21} & T_{23} \end{bmatrix} \begin{bmatrix} b_1 \\ a_1 \\ b_3 \\ a_3 \end{bmatrix} \tag{11}$$

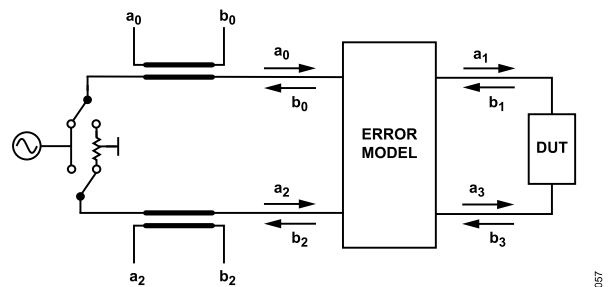

Figure 57. Error Model for Two-Port S-Parameter Measurements

Each of the matrix elements, T in Equation 11, is a 2x2 matrix that describes the interaction between one VNA port and one DUT port, resulting in a total of 16 unknown error coefficients. A wide range of different calibration strategies are reported in literature to determine either a subset of or all of the error coefficients (matrix elements).

One strategy to simplify the error model assumes that the crosstalk between the VNA channels is negligible, that is, that contributions of Port 1 to measurement errors in Port 2, and contributions of Port 3 to measurement errors in Port 0 are very small. This assumption is plausible in a VNA based on the ADL5960, because each VNA port is realized by a separate device. Interaction between the VNA channels can be minimized through careful PCB layout. For this situation, only the block matrices on the diagonal in Equation 11 have nonzero elements, resulting in the following:

THEORY OF OPERATION

$$\begin{bmatrix} b_2 \\ a_2 \end{bmatrix} = T_{23}T_{31}T_{01}^{-1} \begin{bmatrix} b_0 \\ a_0 \end{bmatrix} = T_M \begin{bmatrix} b_0 \\ a_0 \end{bmatrix} \tag{12}$$

where:

T_{31} represents the transmission matrix of the DUT itself (the quantity to be measured).

T_M the transmission matrix measured by the VNA.

The error corrected transmission matrix can then be expressed as follows:

$$T_{CORRECTED} = T_{23}^{-1}T_M T_{01} \tag{13}$$

Many different calibration techniques are available to determine the transmission matrices, T_{01} and T_{23} . One of the simplest yet effective methods is the SOLT calibration, in which a one-port calibration that is applied to each port, followed by measurement of a thru connection (short between Port 1 and Port 3).

Multiport Calibration

Calibration of VNAs consisting of more than two ports can be performed along similar procedures as the two-port calibration discussed in [Two-Port Calibration](#). The number of error coefficients to be determined grows quadratically as $4n^2$, where n is the number of ports. However, when interactions between the VNA ports can be neglected only the coefficients on the block diagonal of the error model need to be taken into account, resulting in $4n$ remaining coefficients.

A practical problem arising with multiport calibration is that calibration standards are usually either one-port (loads) or two-port, whereas the calibration procedure, in principle, requires the measured $n \times n$ S-matrix and an $n \times n$ S-matrix for the actual standard S-parameters. This problem can be addressed by constructing the n -port S-matrix from a series of two-port measurements. [Equation 14](#) illustrates the concept for a four-port system.

$$S = \begin{bmatrix} m_{12} & m_{12} & m_{13} & m_{14} \\ m_{12} & m_{12} & m_{23} & m_{24} \\ m_{13} & m_{23} & m_{13} & m_{34} \\ m_{14} & m_{24} & m_{34} & m_{14} \end{bmatrix} \tag{14}$$

where m_{xy} indicate from which two-port measurement the corresponding S-parameter is determined.

For example, a two-port measurement using Port 1 and Port 2, indicated by m_{12} , can be used to determine s_{11} , s_{12} , s_{21} , and s_{22} . Measurements on different combinations of two ports are needed to fill the entire S-matrix. Some parameters are determined multiple times (like s_{11}) and can be disregarded in all but one measurement. In general, the full set of n^2 S-parameters can be determined with $n(n - 1)/2$ two-port measurement sessions.

When the SOLT calibration method is applied to an n -port VNA, for example, it requires measurement of three loads on each port,

followed by a thru standard measurement between all combinations of two ports. The total number of measurement runs required for this is

$$3n + n(n - 1)/2 = n(n + 5)/2 \tag{15}$$

Rejection of IF Spurious Tones

Besides the desired output signal, a variety of other spurious tones and mixing products are generally present in the IF output signal spectrum. Some of these undesired tones appear at the same frequency as the desired IF signal, and therewith reduce the measurement accuracy. The techniques described in this section can be used to reduce the impact of such undesired tones and enhance the measurement accuracy.

The LO interface configurations that use the OF interface are most vulnerable to IF spurious tones. Harmonics, sub-harmonics, mixing products between the LO and OF, and partially suppressed image frequencies contribute to spurious tones in the IF output spectrum. The impact of spurious tones is most pronounced when the DUT at the RFOUT port is well matched, such that the desired signal in the reverse IF output channel is very small. [Figure 58](#) illustrates the impact of spurious tones at the IF frequency, comparing a return loss measurement result corrected for IF spurious tones and a raw, uncorrected result. As apparent from this figure, spurious tones introduce ripple vs. frequency in the measurement result, and reduce the measurement sensitivity, particularly at frequencies below 5GHz.

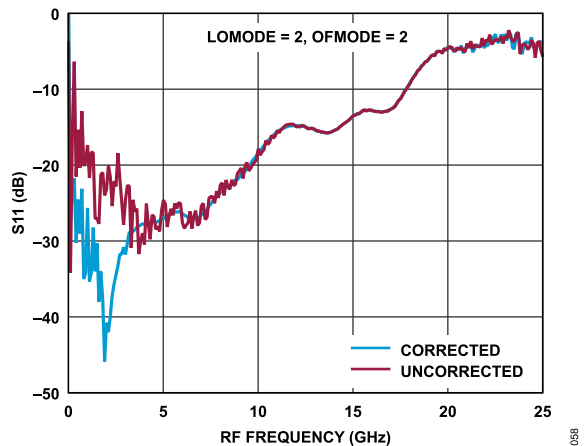

Figure 58. Return Loss Measurement of a 50 Ω Load, With and Without Correction of IF Spurious Tones

The following simple procedure can significantly reduce the ripple due to spurious tones:

1. Measure the IF output signal with RF present.
2. Calculate the complex fast Fourier transform (FFT) frequency component at the IF output frequency.
3. Measure the IF output signal with the RF signal off, or set to a very low level.

THEORY OF OPERATION

4. Calculate the frequency component at the IF frequency for this case.
5. Subtract the result obtained in Step 4 from the result in Step 2.
6. Apply error correction and further processing to the result of Step 5).

The order of the steps described can be changed, and the frequency sweep without RF signal can be stored in memory for correction of future measurements.

APPLICATIONS INFORMATION

INTERFACE DESCRIPTIONS

Power Supply Interfaces

The AVCC, OVCC, and OVDD pins have independent supply clamps and must be ramped slower than 100 μ s to avoid triggering the clamps. Decoupling of the supply interfaces with 1 nF/4.7 μ F capacitors is recommended to suppress residual high-frequency ripple. OVDD can be connected to the supply of the SPI controller to eliminate the need for logic level translators in the SPI bus lines. To prevent damages to the device, the following sequence must be followed. On power-up, apply the AVCC and OVCC voltages before the OVDD voltage. On power-down, remove the OVDD voltage before the AVCC and OVCC voltages.

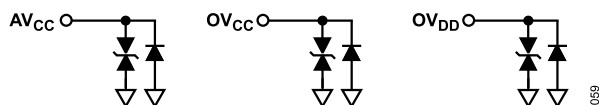

Figure 59. Simplified Power Supply Interface Schematics

RFIN and RFOUT Interface

RFIN and RFOUT are both single-ended RF inputs with 50 Ω characteristic impedance. Because both interfaces are internally coupled, the input impedance observed at RFIN (or RFOUT) is 50 Ω if, and only if, the other interface, RFOUT (or RFIN) is terminated with 50 Ω .

Both pins are internally DC-coupled through a 6 Ω series resistance of the bidirectional bridge. DC currents up to 100 mA can be safely passed through the bridge to bias a DUT such as an RF amplifier. The bridge is designed to support average signal levels up to 30 dBm in matched conditions and peak levels up to 35 dBm. Signal voltages on the interfaces must stay within the range from -5 V to +10 V under extreme mismatched conditions, such as an open circuit, that can result in larger voltage swings than observed with a matched termination.

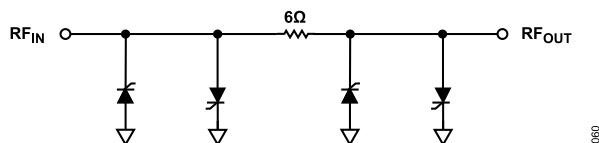

Figure 60. Simplified RFIN and RFOUT Interfaces

To achieve the best possible bridge directivity, both RFIN and RFOUT must be connected to carefully matched 50 Ω broadband transmission lines. A grounded coplanar waveguide (GCPW) as shown in Figure 61 is a suitable implementation for this purpose. Use Pin 2 and Pin 4 (AGND) as the RF return path for the RFIN interface, and use Pin 18 and Pin 20 as the return path for the RFOUT interface. A ground shield between RFIN and RFOUT is necessary to minimize interaction outside of the bridge, which also impacts the measured directivity. The top ground and bottom ground layers must be connected with as many vias as possible in

the shield between RFIN and RFOUT and around the edge of the ground return conductors of the GCPW.

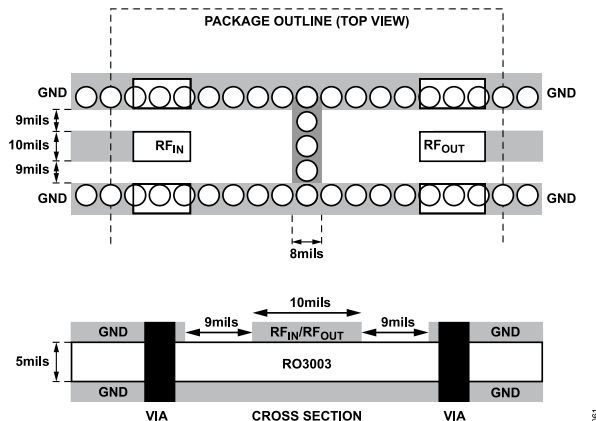

Figure 61. Example GCPW Design for Interfacing RFIN and RFOUT

IFFP, IFFM, IFRP, and IFRM Interfaces

The differential IF output amplifiers are capable of driving 100 Ω differential loads up to 8 V p-p. In the event of an output short circuit to ground or AVCC, an internal clamp limits the current to less than roughly 200 mA for each of the single-ended outputs (IFFM, IFFP, IFRP, and IFRM).

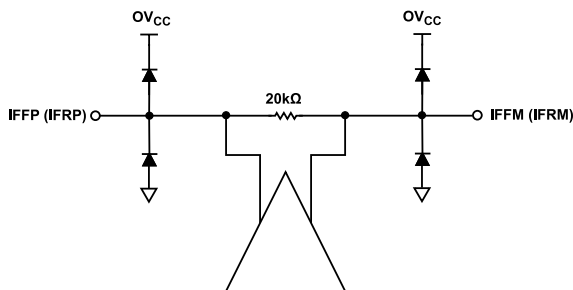

Figure 62. Simplified Schematic of the IF Output Interfaces

VCM Interface

The VCM interface controls the common-mode voltage level at the IFFx and IFRx output interfaces and simplifies DC-coupled interfacing to a wide variety of ADCs. If provided by the ADC of choice, this pin can be connected to the common-mode output or reference output pin to align the common-mode levels and maximize the available dynamic range.

When the VCM pin is left floating, an internal voltage-divider sets the common-mode voltage level to OVCC/2. When externally driven, a low-impedance voltage source must be used to set the voltage on this pin. The tracking range of the VCM pin voltage to the common-mode output voltage is linear in the range from 1 V to 4 V. For voltage levels outside this range, the output common-mode level is clamped to 1 V or 4 V, respectively.

APPLICATIONS INFORMATION

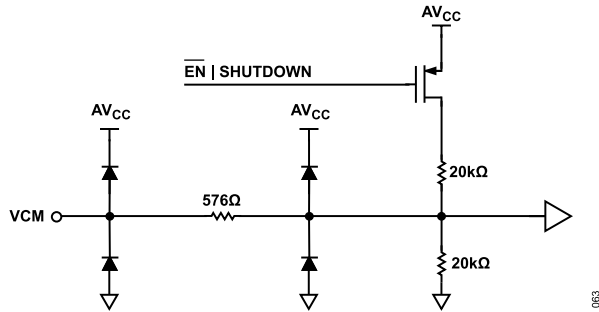

Figure 63. Simplified Schematic of the Common-Mode Control Interface

LOP and LOM Interface

The LO interface can be driven differentially or single-ended. A differentially driven LO with a well designed PCB layout (for example, using a ground, signal, signal, ground coplanar waveguide) can help to reduce LO signal radiated emission and unwanted coupling to other nets in the system. The LOP and LOM inputs are internally biased at AVCC/2. When driven single-ended, the internal 100 Ω termination can be impedance matched using a 2:1 external balun.

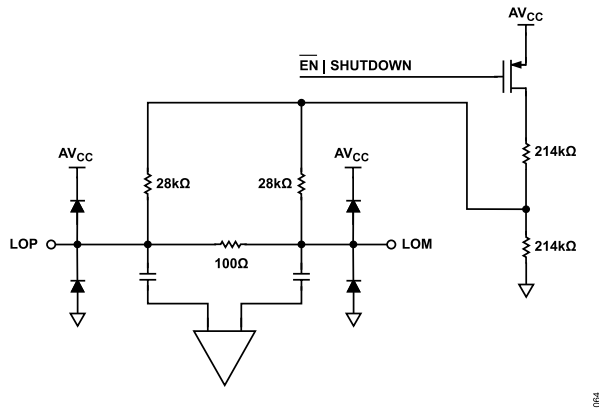

Figure 64. Simplified LO Interface

OFP and OFM Interface

The offset frequency interface (OFP and OFM) is internally biased at a common-mode level of 3.3 V, and must be AC-coupled to an external signal source. The inputs can be driven differentially or single-ended with one terminal AC-grounded with a high value capacitor. A value of 10 nF or higher is recommended for a 400 kHz input frequency.

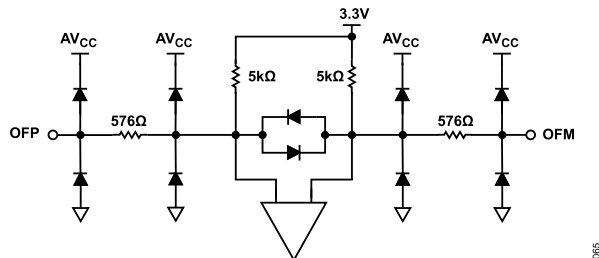

Figure 65. Simplified Offset Frequency Interface

EN Interface

The chip is in shutdown if either the shutdown bit in DEVICE_CONFIG (Register 0x02, Bit 1) is set, or the EN pin is deasserted. An internal 415 kΩ pull-down ensures the device is off (shut down) if the pin is left floating.

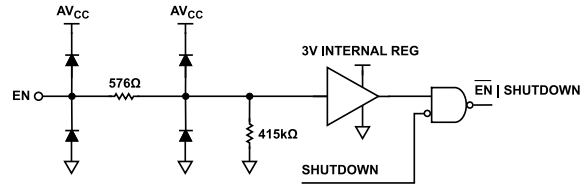

Figure 66. Simplified Enable Interface

SYNC and SCK Interfaces

The SYNC and SCK interfaces are both high-impedance CMOS logic input interfaces. As listed in Table 1, the logic high and logic low levels are defined relative to the serial port supply interface, OVDD. Both inputs are internally pulled low when left floating.

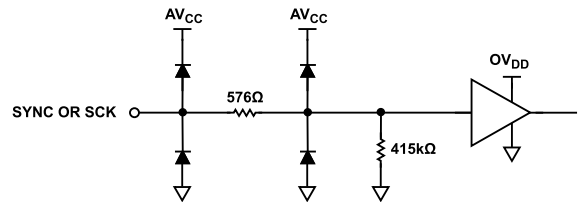

Figure 67. SYNC and SPI Clock Interface

The SYNC interface is used to synchronize all ADL5960 devices in a system. A falling edge on this interface resets the frequency dividers in the LO and OF interfaces to a known, predefined state. All ADL5960 devices receive the negative SYNC edge before the next edge on the LO or OF interface arrives. The SYNC pulse can also be applied directly after power-on, before an LO and OF clock are applied.

CS Interface

The CS interface controls the start and ending of the communication through the serial interface of the device. The SPI is active when the voltage on CS represents logic low and is disabled when the voltage on CS is logic high, as defined in Table 1. The input is internally pulled high, disabling the SPI, when this pin is left floating.

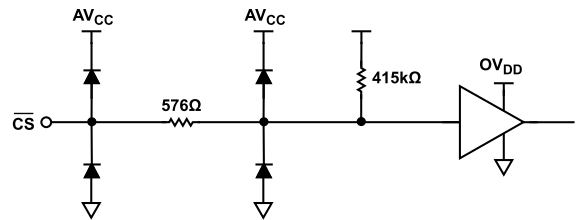

Figure 68. SPI Chip Select Interface

APPLICATIONS INFORMATION

SDIO Interface

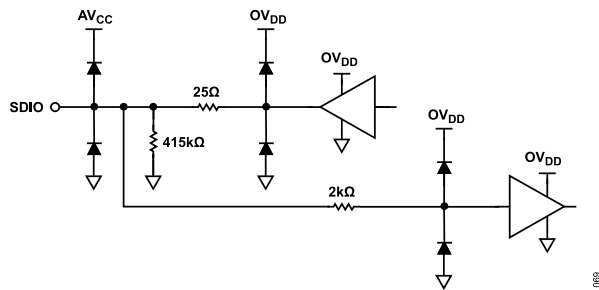

Figure 69. Simplified SDIO Interface

The ADL5960 implements a 3-wire SPI that uses a single line for transmission/reception of data. When receiving data, that is, during a write operation to the device, the transmitter output becomes high-impedance such that the transmitting device can pull the data line low or high as desired. To connect this interface to an SPI controller using a 4-wire interface, with separate data input and data output lines, a series current limiting resistor as shown in Figure 70 is recommended to isolate the controller and target outputs. This resistor provides protection in the event that both outputs become simultaneously active.

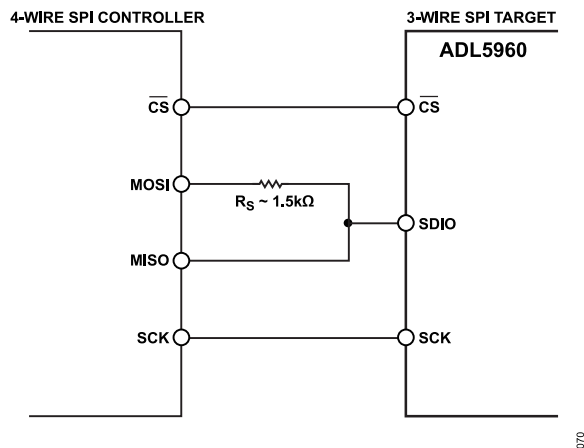

Figure 70. SPI 4-Wire to 3-Wire Interfacing

TEMP Interface

In addition to the on-chip digital thermometer, the TEMP pin can be used to monitor the die temperature by applying a known reference current into the pin and measure the pin voltage relative to ground. An injected current of 42 μA results in a nominal voltage of 0.775 V at 25°C and a temperature slope of approximately $-1.54 \text{ mV}/^\circ\text{C}$.

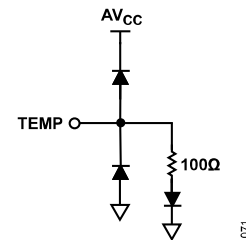

Figure 71. Temperature Diode Interface

LO INTERFACE CONFIGURATION

The LO interface supports a bypass mode and four different multiply/divide modes that are selectable through register 0x20 in the SPI interface. Each of these operating modes is discussed in the [Bypass Mode \(Bypass = 1\)](#) section to [Multiply by 4 Mode \(LOMODE = 3\)](#) section.

Bypass Mode (Bypass = 1)

The LO signal is routed directly to the internal downconversion mixers, bypassing the frequency multipliers and dividers. The LO multipliers and dividers and the OF interface are disabled. The ADL5960 achieves the widest bandwidth and highest dynamic range in this mode.

Divide by 2 Mode (LOMODE = 0)

The frequency of the LO input signal is divided by two before being passed through the offset mixer and supplied to the downconversion mixers. If supported by the frequency range of the RF signal, this LO operating mode provides a means to extend the VNA measurements frequency range below the minimum frequency supported by the LO source itself. This operating mode can be used either with the offset frequency interface enabled or disabled.

Multiply by 1 Mode (LOMODE = 1)

The LO signal bypasses the LO multipliers and dividers but is routed through the offset mixer to the downconversion mixers. The intended use is with the offset frequency interface enabled. Although it can be used with the offset frequency interface disabled, improved performance is achieved by selecting the bypass mode (bypass = 1) instead.

Multiply by 2 Mode (LOMODE = 2)

The LO signal is passed through a frequency doubler, a programmable band-pass filter, and an offset mixer to the downconversion mixers. The band-pass filter suppresses the subharmonics in the doubler output signal and can be tuned by programming the CT2 bit field in Register 0x21. Table 7 lists the recommended setting for different $2\times$ LO frequency ranges. All CT2 settings are valid. For CT2 settings not shown in the table, for example CT2=2, CT2=5, ... CT2=30, the minimum and maximum $2\times f_{LO}$ can be linearly interpolated based on the table entries shown. The multiply

APPLICATIONS INFORMATION

by 2 mode can be used standalone or in combination with the offset frequency interface.

Table 7. Recommended CT2 Band-Pass Filter Settings for LOMODE = 2

CT2	Minimum 2× f _{LO} (GHz)	Maximum 2× f _{LO} (GHz)
0	15	20
1	14	15
3	11	14
4	10	12
6	9	10
8	8	9
12	7	8
15	6	7
22	5	6
31	4	5

Multiply by 4 Mode (LOMODE = 3)

The LO signal is passed first through a frequency doubler, followed by the band-pass filter tuned through the CT2 bit field, through a second frequency doubler, and followed by a second band-pass filter tuned through the CT4 bit field in Register 0x22. Finally, the signal is passed through the offset mixer to the downconversion mixers. Table 8 lists the recommended setting for different 4× LO frequency ranges. The list is not exhaustive. Other valid combinations exist that result in frequency ranges partially or entirely overlapping with the recommended settings. This mode can be used standalone or in combination with the offset frequency interface.

Table 8. Recommended CT2 and CT4 Band-Pass Filter Settings for LOMODE = 3

CT2	CT4	Minimum 4× f _{LO} (GHz)	Maximum 4× f _{LO} (GHz)
<5	<12	>20	>21
5	12	20	21
6	13	19	20
7	14	17	19
12	15	14	17

IF SIGNAL PATH CONFIGURATION

The IF signal path following the downconversion mixers can be configured to optimize the output signal dynamic range and to achieve optimal interfacing to a wide range of ADCs.

Two cascaded low-pass filters provide programmable IF bandwidth for suppression of out of band noise and spurious tones. The first filter provides coarse bandwidth adjustment through the CIF1 bit field in Register 0x25, as listed in Table 9 and shown in Figure 22.

Table 9. IF -3 dB Bandwidth vs. CIF1 with CIF2 = 0

CIF1	f _{-3dB} (MHz)	CIF1	f _{-3dB} (MHz)
0	126	8	13.0
1	64.0	9	11.6
2	41.0	10	10.5
3	30.1	11	9.5

Table 9. IF -3 dB Bandwidth vs. CIF1 with CIF2 = 0 (Continued)

CIF1	f _{-3dB} (MHz)	CIF1	f _{-3dB} (MHz)
4	24.1	12	8.8
5	19.7	13	8.1
6	16.7	14	7.6
7	14.5	15	7.0

The second filter provides finely spaced lower bandwidth settings programmable through the CIF2 bit field in Register 0x25, listed in Table 10 and shown in Figure 25. Both output channels are programmed to the same IF bandwidth.

Table 10. IF -3 dB Bandwidth vs. CIF2 with CIF1 = 0

CIF2	f _{-3dB} (MHz)	CIF2	f _{-3dB} (MHz)
0	126	8	1.5
1	11.1	9	1.3
2	5.9	10	1.2
3	3.8	11	1.0
4	3.1	12	0.99
5	2.3	13	0.86
6	2	14	0.80
7	1.6	15	0.70

Following the filters are differential output amplifiers with individually programmable gain. The adjustable gain feature is to accommodate the actual RF drive level in use, and the feature also enables dynamic range optimization of both the forward and reverse channels over a wide range of port terminations. For example, if the bridge is terminated with an impedance close to 50 Ω, the bridge output signal level in the reverse (reflected) channel is much lower than in the forward (incident) channel. To compensate for this difference, the reverse channel amplifier can be programmed to a higher gain setting than the forward channel, so both channels use the full input dynamic range of the ADC connected to the IF outputs. To achieve optimal measurement accuracy, a calibration procedure must cover all used gain setting combinations for the forward and reverse channels.

The gain for the forward and reverse channel can be programmed through the FGAIN bit field in Register 0x23 and the RGAIN bit field in Register 0x24, respectively, in 6 dB steps, as shown in Table 11. Note that the bit field values also need to be increased in steps of 6 to select the next gain setting (see Figure 20). Although gain levels beyond 48 dB are supported, these levels are usually of little practical significance because amplified noise starts to saturate the IF channels.

Table 11. IF Amplifier Gain vs. FGAIN and RGAIN Settings

FGAIN, RGAIN	IF Gain (dB)
0 to 5	0
6 to 11	6
12 to 17	12
18 to 23	18

APPLICATIONS INFORMATION

Table 11. IF Amplifier Gain vs. FGAIN and RGAIN Settings (Continued)

FGAIN, RGAIN	IF Gain (dB)
24 to 29	24
30 to 35	30
36 to 41	36
42 to 47	42
48 to 53	48
...	...

For best overall measurement accuracy, large-signal non-linearity of the signal chain must be minimized. At FGAIN (or RGAIN) values greater than 0, the ADL5960 exhibits a slight large-signal gain expansion characteristic, up to 1 dB. This can introduce small errors in the measured transmission or reflection coefficients. One way to mitigate a non-linearity error is to calibrate at lower input power levels, ≤ 0 dBm for example. Another technique to mitigate a non-linearity error is by using a polynomial curve fit and applying a correction after ADC conversion in the digital domain. For a solution involving external hardware, set FGAIN (or RGAIN) = 0 and add a high-precision ADC driver, such as the [ADA4945](#).

Finally, the adjustable output common-mode level, up to 8 V p-p output-voltage swing and up to 200 mA current drive capability, provide enough flexibility to interface with a broad range of suitable Σ - Δ , successive approximation register (SAR), or pipeline-based ADCs with sample rates up to several hundred MHz.

SERIAL PERIPHERAL INTERFACE

PROTOCOL

The ADL5960 can be connected to an SPI bus as a peripheral device to control and monitor several of its internal functions. See the [Serial Interface Timing Specifications](#) section for detailed timing requirements. The 3-wire interface with a shared data input and output line uses 16-bit addresses to access the 8-bit wide registers. Each SPI instruction consists of the register address followed by one or more data bytes, with the MSB transferred first. The device supports single-byte read and write operations as well as streaming read and write methods.

REGISTER ADDRESS

The 15 LSBs of the 16-bit register address define an address space with $2^{15} = 32,768$ unique register addresses. Only a fraction of these addresses is used by the ADL5960. The MSB is reserved to distinguish between a write operation to the device register (MSB = 0) and a readback from the register address (MSB = 1).

READ AND WRITE METHODS

The ADL5960 supports both single register read and write methods and streaming read and write methods, transferring data to and from multiple registers in a single operation.

Each instruction starts with a high to low transition of the \overline{CS} line. Data is latched, starting with the MSB address bit, at each rising edge of the clock as long as \overline{CS} remains low. The instruction ends

with a low to high transition on \overline{CS} . When a read instruction is executed, the SDIO shared input and output line changes from a high-impedance input (SDI) to a low-impedance output (SDO) during the $\frac{1}{2}$ clock cycle immediately following the rising edge on SCLK that latched the last address bit, and the next falling edge on SCLK. SDIO returns to a high-impedance input (SDI) state when \overline{CS} is deasserted.

Streaming read and write methods operate in autodecrement mode only, reading and writing the next data byte to and from the register with the address that is one lower than the previous one.

REGISTER DETAILS

Register 0x00 through Register 0x05 configure the SPI and contain device identifiers. Register 0x20 to Register 0x26 control the analog circuit functionality of the device. Refer to [Table 12](#) for details.

Interface Configuration Register

Register 0x00 is the serial interface configuration register and is implemented as a 4-bit palindrome with each nibble a mirror of the other. This mirror ensures that regardless of which way data is shifting, the device can be programmed if device synchronization is lost. Therefore, when writing to this address, the palindrome is always required to eliminate any ambiguity in configuring this register.

Table 12. ADL5960 SPI Register Details

Addr	Name	Bits	Bit Name	Description	Reset	Access
0x00	SPI_CONFIG_A	7	SOFTRESET_	Soft Reset. Copy of Bit 0	0x0	R/W
		6	LSB_FIRST_	LSB First. Copy of Bit 1	0x0	R/W
		5	ASCENSION_	Address Ascension. Copy of Bit 2.	0x0	R/W
		[4:3]	RESERVED	Reserved.	0x0	R
		2	ASCENSION	Address Ascension. When set, causes address ascension address mode to be enabled. When clear, addresses descend. 0: Address Autodecrement. 1: Address Autoincrement.	0x0	R/W
		1	LSB_FIRST	LSB First. When set, causes input and output data to be oriented as LSB first. If this bit is clear, the data is oriented as MSB first. 1: LSB First. 0: MSB First.	0x0	R/W
		0	SOFTRESET	Soft Reset. Setting this bit initiates a reset equivalent to a hard reset with the exception that the bits of 0x00 (this register) and the SPI state machine are unaffected. This bit is autoclearing after the soft reset is complete. 1: Reset Asserted. 0: Reset Not Asserted.	0x0	R/W
0x01	SPI_CONFIG_B	7	SINGLE_INSTRUCTION	Single Instruction. When this bit is set, streaming is disabled and only one read or write operation is performed regardless of the state of the \overline{CS} line. When this bit is clear, streaming is enabled. If this bit is set and the \overline{CS} remains asserted, the state machine resets after the data byte as if \overline{CS} was deasserted and awaits the next instruction. This forces each data byte to be preceded with a new instruction even though the \overline{CS} line has not been deasserted by the SPI controller.	0x0	R/W

SERIAL PERIPHERAL INTERFACE

Table 12. ADL5960 SPI Register Details (Continued)

Addr	Name	Bits	Bit Name	Description	Reset	Access
0x02	DEVICE_CONFIG	6	CSB_STALL	\overline{CS} Stalling. When Single Instruction is enabled and \overline{CS} stalling is enabled, the \overline{CS} signal does not reset the SPI state machine when pulled high. When \overline{CS} stalling is disabled, the SPI state machine always resets when \overline{CS} signal is high.	0x0	R/W
		5	CONTROLLER_TARGET_RB	Controller or Target Device Readback. Setting this bit allows readback of the SPI controller flip-flop outputs. Clearing this bit provides access to the internal SPI register outputs.	0x0	R/W
		[4:0]	RESERVED	Reserved.	0x0	R
		[7:2]	RESERVED	Reserved.	0x0	R/W
		1	SHUTDOWN	Device Shutdown. If shutdown is asserted, the device is powered off. See also the EN Interface section. 0: Normal Operation. 1: Shutdown.	0x0	R/W
0	RESERVED	Reserved.	0x0	R		
0x03	CHIPTYPE	[7:0]	CHIPTYPE	Chip Type, read only.	0x1	R
0x04	PRODUCT_ID_L	[7:0]	PRODUCT_ID_L	Product_ID_L, lower 8 Bits.	0x60	R
0x05	PRODUCT_ID_H	[7:0]	PRODUCT_ID_H	Product_ID_H, higher 8 Bits.	0x59	R
0x20	LO_CONFIG	[7:5]	RESERVED	Reserved.	0x0	R
		4	BYPASS	Bypass LO Path. When asserted, the LO chain is configured to have all multipliers and dividers turned off. IFMODE and LOMODE have no effect. The LO inputs are connected to the RF mixers by the LO amplifier only.	0x1	R/W
		[3:2]	OFMODE	OFMODE. Configures the divider in the offset reference frequency interface. 00: $\times 1$ no dividers enabled. 01: Divide by 2 mode. 10: Divide by 4 mode. 11: Dividers off, offset reference signal disconnected.	0x2	R/W
		[1:0]	LOMODE	LOMODE. Configures the LO chain divider and multipliers. 00: Divide by 2. 01: Multiply by 1 \times . 10: Multiply by 2 (2 \times). 11: Multiply by 4 (4 \times).	0x1	R/W
0x21	CT2	[7:5]	RESERVED	Reserved.	0x0	R
		[4:0]	CT2	CT2 Filter Setting. Sets the center frequency of the filter in the 2 \times frequency multiplier in the LO interface.	0x0	R/W
0x22	CT4	[7:4]	RESERVED	Reserved.	0x0	R
		[3:0]	CT4	CT4 Filter Setting. Sets the center frequency of the filter in the 4 \times frequency multiplier in the LO interface.	0x0	R/W
0x23	FGAIN	7	RESERVED	Reserved.	0x0	R
		[6:0]	FGAIN	Forward Gain. Configures the gain of the IF amplifier in the forward path, to the IFFP and IFFM output, in 6 dB steps. Decimal register value represents the gain in dB.	0x0	R/W
0x24	RGAIN	7	RESERVED	Reserved.	0x0	R
		[6:0]	RGAIN	Reverse Gain. Configures the gain of the IF amplifier in the reverse path, to the IFRP and IFRM output, in 6 dB steps. Decimal register value represents the gain in dB. Refer to Table 11 .	0x0	R/W
0x25	CIF2_CIF1	[7:4]	CIF2	Narrow-Band IF Filter Setting. Sets the corner frequency of the narrow bandwidth IF filter. Refer to Figure 25 .	0x0	R/W
		[3:0]	CIF1	Wideband IF Filter Setting. Sets the corner frequency of the wide bandwidth IF filter. Refer to Figure 22 .	0x0	R/W
0x26	TDEG	[7:5]	RESERVED	Reserved.	0x0	R

SERIAL PERIPHERAL INTERFACE

Table 12. ADL5960 SPI Register Details (Continued)

Addr	Name	Bits	Bit Name	Description	Reset	Access
		[4:0]	TDEG	Thermometer Register. A 5-bit thermometer read-out. Refer to Figure 40 . Approximately 7.4°C/step, TDEG = 0 to TDEG = 1 transition at -44.6°C.	0x0	R

TYPICAL APPLICATION TEST CIRCUIT

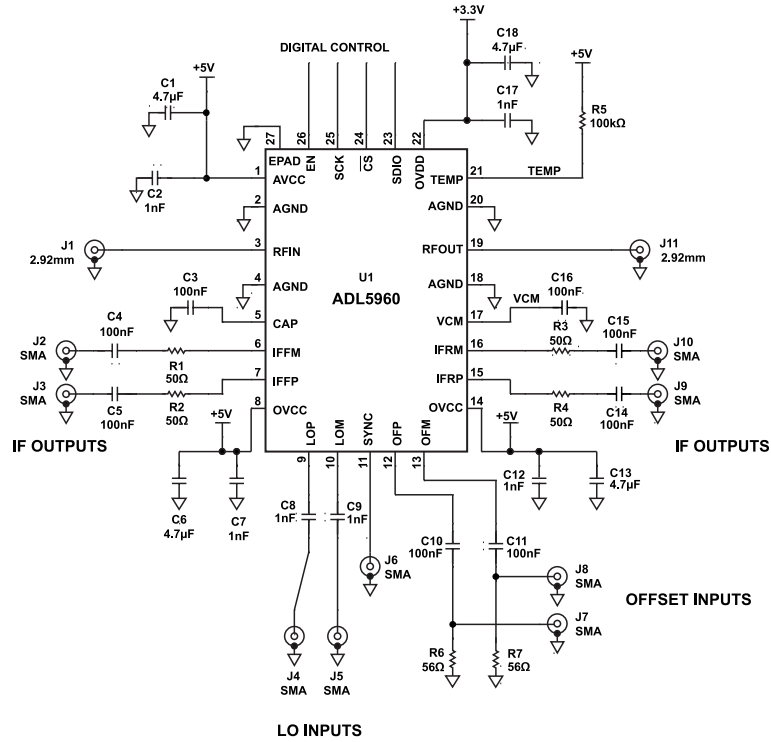

Figure 72. Test Circuit

See the [EVAL-ADL5960](#) user guide for details on the evaluation board components.

OUTLINE DIMENSIONS

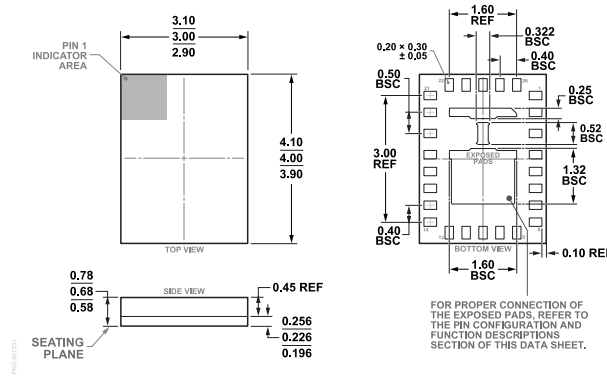

Figure 73. 26-Lead Land Grid Array [LGA]
3 mm x 4 mm
(CC-26-2)
Dimensions shown in millimeters

ORDERING GUIDE

Model ¹	Temperature Range	Package Description	Packing Quantity	Package Option
ADL5960ACCZ	-40°C to +105°C	26-Lead Land Grid Array [LGA]	Cut Tape, 1	CC-26-2
ADL5960ACCZ-R2	-40°C to +105°C	26-Lead Land Grid Array [LGA]	Reel, 250	CC-26-2
ADL5960ACCZ-R7	-40°C to +105°C	26-Lead Land Grid Array [LGA]	Reel, 1500	CC-26-2

¹ Z = RoHS Compliant Part.

EVALUATION BOARDS

Model ^{1, 2, 3}	Description
ADL5960-EVALZ	Evaluation Board
ADL5960-KIT-EVALZ	RF Evaluation Board Kit

¹ Z = RoHS Compliant Part.

² The ADL5960-EVALZ package includes the board only.

³ A preprogrammed DC2026C Linduino One controller board is included with the ADL5960-KIT-EVALZ.

Mouser Electronics

Authorized Distributor

Click to View Pricing, Inventory, Delivery & Lifecycle Information:

[Analog Devices Inc.:](#)

[ADL5960ACCZ-R7](#) [ADL5960ACCZ-R2](#) [ADL5960ACCZ](#) [ADL5960-EVALZ](#) [ADL5960-KIT-EVALZ](#)