



Q20 Series Sensor

Original Instructions

p/n: 127816 Rev. O

06-May-25

© Banner Engineering Corp. All rights reserved. www.bannerengineering.com

Contents

Chapter 1 Features	3
Models	3
Chapter 2 Overview	5
Wiring Diagrams	5
Chapter 3 Specifications	6
FCC Part 15 Class B for Unintentional Radiators.....	7
Industry Canada ICES-003(B).....	7
Performance Curves.....	7
Dimensions.....	9
Chapter 4 Accessories	10
Mounting Brackets.....	10
Cross Talk Prevention Filters.....	11
Quick-Disconnect (QD) Cordsets	11
Q20 Apertures	12
Chapter 5 Product Support and Maintenance	13
Clean Sensor with Compressed Air Then Isopropyl Alcohol	13
Repairs	13
Contact Us.....	13
Banner Engineering Corp Limited Warranty.....	13

Chapter 1 Features



- Photoelectric sensors in a compact, rugged, sealed, overmolded plastic housing
- Standard 3 mm threaded mounting holes on 25.4 mm (1 in) spacing
- Advanced electronic design for excellent noise immunity and cross-talk avoidance
- Threaded metal M8 connector on certain quick-disconnect models
- 10 V DC to 30 V DC operation with complementary solid-state outputs (1 normally open, 1 normally closed); PNP or NPN, depending on model
- Complete offering of mounting brackets and apertures available
- Crosstalk prevention filters are available for visible red opposed mode pairs
- Exceptional optical performance with easy-to-align visible red emitters
- Background suppression models provide reliable detection up to 150 mm while ignoring objects in the background
- Background suppression models provide stable detection in the presence of fluorescent lights

WARNING:



- Do not use this device for personnel protection
- Using this device for personnel protection could result in serious injury or death.
- This device does not include the self-checking redundant circuitry necessary to allow its use in personnel safety applications. A device failure or malfunction can cause either an energized (on) or de-energized (off) output condition.

Models

Model	Sensing Mode	Range	Output
Q20E	Opposed, 624 nm Visible Red Effective Beam: 10 mm (0.4 in)	12 m (39.4 ft)	N/A
Q20PR			PNP
Q20NR			NPN
Q20EL	Opposed, 850 nm Infrared Effective Beam: 10 mm (0.4 in)	20 m (65.6 ft)	N/A
Q20PRL			PNP
Q20NRL			NPN
Q20PLP	Polarized Retroreflective, 645 nm Visible Red	4 m (13 ft) (specified using reflector BRT-84)	PNP
Q20NLP			NPN
Q20PLV	Retroreflective, 645 nm Visible Red	6 m (20 ft) (specified using reflector BRT-84)	PNP
Q20NLV			NPN
Q20PDL	Long-Range Diffuse, 624 nm Visible Red	800 mm (32 in)	PNP
Q20NDL			NPN

Model	Sensing Mode	Range	Output
Q20PDXL	Long Range Diffuse, 850 nm Infrared	1500 mm (59 in)	PNP
Q20NDXL			NPN

Continued on page 4

Continued from page 3

Model	Sensing Mode	Range	Output
Q20PD	Short Range Diffuse, 624 nm Visible Red	250 mm (10 in)	PNP
Q20ND			NPN
Q20PDVS	Small Spot Diffuse, 660 nm Visible Red	250 mm (10 in)	PNP
Q20NDVS			NPN
Q20PFF50	Fixed Field, 655 nm Visible Red	50 mm (2 in) cutoff	PNP
Q20NFF50			NPN
Q20PFF100		100 mm (4 in) cutoff	PNP
Q20NFF100			NPN
Q20PFF150		150 mm (6 in) cutoff	PNP
Q20NFF150			NPN

Diffuse-mode and fixed-field performances are based on the use of a 90% reflectance white test card.

Integral 2 m (6.5 ft) unterminated cable models are listed.

- To order the 9 m (30 ft) PVC cable model, add the suffix "W/30" to the cabled model number. For example, Q20E W/30.
- To order the 4-pin M8 integral quick disconnect model, add the suffix "Q7" to the model number. For example, Q20EQ7.
- To order the 150 mm (6 in) PVC cable model with a 4-pin M8 quick disconnect, add the suffix "Q" to the model number. For example, Q20EQ.
- To order the 150 mm (6 in) PVC cable model with a 4-pin M12 quick disconnect, add the suffix "Q5" to the model number. For example, Q20EQ5.
- To order the 150 mm (6 in) PUR cable model with a 4-pin M12 quick disconnect, add the suffix "QPMA" to the model number. For example, Q20EQPMA.
- Models with a quick disconnect require a mating cordset.

Models are available with Health or Alarm Mode output; contact Banner Engineering for details.

Chapter 2 Overview

Banner's Q20 family of sensors offers a full complement of sensing modes, with the excellent performance expected of much larger sensors. Their compact plastic housings feature overmolded construction for superior robustness and sealing. Their popular rectangular design is easy to mount into tight spaces; integral threaded mounting holes eliminate the need for separate mounting nuts.

The single-turn Gain potentiometer on most models and bright LEDs (positioned on top of the housing for 360° visibility) provide easy alignment and configuration for reliable sensing.

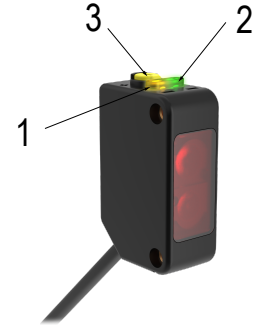

1. Output LED
2. Power LED
3. Single-Turn Gain Potentiometer (Retro and Diffuse models only)

Wiring Diagrams

Cabled wiring diagrams are shown. Quick disconnect wiring diagrams are functionally identical.

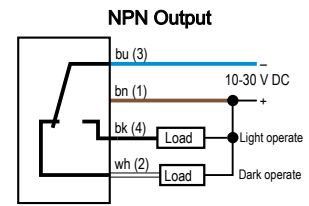
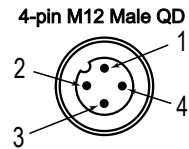
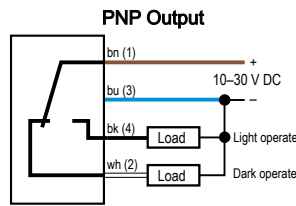
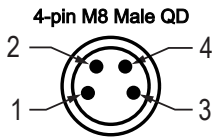
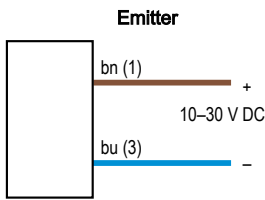

1. Brown
2. White
3. Blue
4. Black

Chapter Contents

FCC Part 15 Class B for Unintentional Radiators 7
 Industry Canada ICES-003(B)..... 7
 Performance Curves 7
 Dimensions..... 9

Chapter 3 Specifications

Supply Voltage

Fixed-Field: 10 V DC to 30 V DC (10% maximum ripple within specified limits) at less than 25 mA, exclusive of load
All others: 10 V DC to 30 V DC (10% maximum ripple within specified limits) at less than 18 mA, exclusive of load

Supply Protection Circuitry

Protected against reverse polarity and transient voltages

Repeatability

Opposed mode: 140 microseconds
 All other models: 90 microseconds

Construction

ABS housing; PMMA lenses; PBT Gain Adjuster (Retro and Diffuse models only)

Output Configuration for Receiver

100 mA with short circuit protection
 OFF-state leakage current:
 NPN: < 200 µA sinking (see Application Note 2);
 PNP: < 10 µA sourcing
 ON-state saturation voltage
 NPN: < 1.6 V at 100 mA
 PNP: < 3.0 V at 100 mA

Output Configuration for all Other Models

Maximum Current ≤ 100 mA
 PNP Output Voltage:
 High ≥ Vsupply – Vsaturation
 Low ≤ 1 V (≤ 1M Ω)
 NPN Output Voltage:
 High ≥ Vsupply – 1 V (≤ 1M Ω)
 Low ≤ Vsaturation
 Vsaturation ≤ 3 V

Output Response Time

Opposed mode: 1 millisecond ON/600 microseconds OFF
 All other models: 850 microseconds ON/OFF
 100 millisecond delay on power-up; outputs do not conduct during this time

Connections

2 m (6.5 ft) or 9 m (30 ft) 4-wire PVC cable, 150 mm (6 in) cable with 4-pin threaded M8 (Q) or M12 (Q5) connector, or 4-pin integral threaded M8 connector (Q7), depending on the model ordered

Indicators

Two LED Indicators: Power (green) and Output (amber)
 Fixed-Field models:
 Green on: Power ON
 Amber on: Black (LO) wire conducting
 All other models:
 Green on: Power ON
 Amber on: Black (LO) wire conducting
 Amber flashing: Marginal excess gain (1 to 1.5×)
 Black (LO) wire conducting

Adjustments

Diffuse, Retroreflective, and Polarized Retroreflective models (only): Single-turn Sensitivity (Gain) adjustment potentiometer

Operating Conditions

–20 °C to +60 °C (–4 °F to +140 °F)
 95% at +50 °C maximum relative humidity (non-condensing)

Environmental Rating

IP67; NEMA 6

Vibration and Mechanical Shock

Applications Notes

- Opposed mode sensor spacing can be reduced by alternating emitters and receivers or by applying cross talk filters (visible red models only)
- For receiver only: NPN off-state leakage current is <200 µA for load resistances > 3kΩ or optically isolated loads. For load currents of 100 mA, leakage is <1% of load current.

Certifications



Banner Engineering BV
 Park Lane, Culliganlaan 2F bus 3
 1831 Diegem, BELGIUM



Turck Banner LTD Blenheim House
 Blenheim Court
 Wickford, Essex SS11 8YT
 GREAT BRITAIN



(Class 2 power supply required)

Required Overcurrent Protection



WARNING: Electrical connections must be made by qualified personnel in accordance with local and national electrical codes and regulations.

Overcurrent protection is required to be provided by end product application per the supplied table.

Overcurrent protection may be provided with external fusing or via Current Limiting, Class 2 Power Supply.

Supply wiring leads < 24 AWG shall not be spliced.

For additional product support, go to www.bannerengineering.com.

Supply Wiring (AWG)	Required Overcurrent Protection (A)	Supply Wiring (AWG)	Required Overcurrent Protection (A)
20	5.0	26	1.0
22	3.0	28	0.8
24	1.0	30	0.5

FCC Part 15 Class B for Unintentional Radiators

(Part 15.105(b)) This equipment has been tested and found to comply with the limits for a Class B digital device, pursuant to part 15 of the FCC Rules. These limits are designed to provide reasonable protection against harmful interference in a residential installation. This equipment generates, uses, and can radiate radio frequency energy and, if not installed and used in accordance with the instructions, may cause harmful interference to radio communications. However, there is no guarantee that interference will not occur in a particular installation. If this equipment does cause harmful interference to radio or television reception, which can be determined by turning the equipment off and on, the user is encouraged to try to correct the interference by one or more of the following measures:

- Reorient or relocate the receiving antenna.
- Increase the separation between the equipment and receiver.
- Connect the equipment into an outlet on a circuit different from that to which the receiver is connected.
- Consult the dealer or an experienced radio/TV technician for help.

(Part 15.21) Any changes or modifications not expressly approved by the party responsible for compliance could void the user's authority to operate this equipment.

Industry Canada ICES-003(B)

This device complies with CAN ICES-3 (B)/NMB-3(B). Operation is subject to the following two conditions: 1) This device may not cause harmful interference; and 2) This device must accept any interference received, including interference that may cause undesired operation.

Cet appareil est conforme à la norme NMB-3(B). Le fonctionnement est soumis aux deux conditions suivantes : (1) ce dispositif ne peut pas occasionner d'interférences, et (2) il doit tolérer toute interférence, y compris celles susceptibles de provoquer un fonctionnement non souhaité du dispositif.

Performance Curves

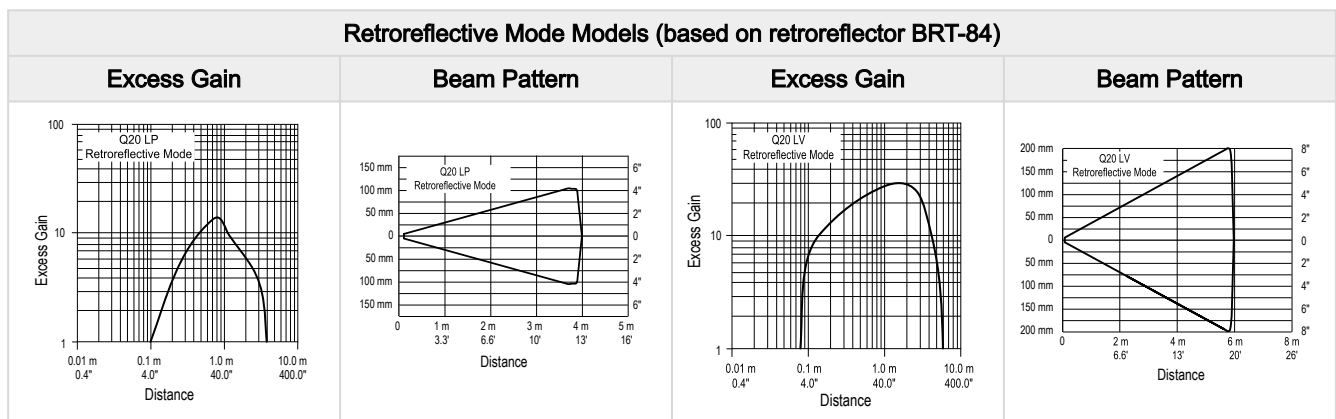
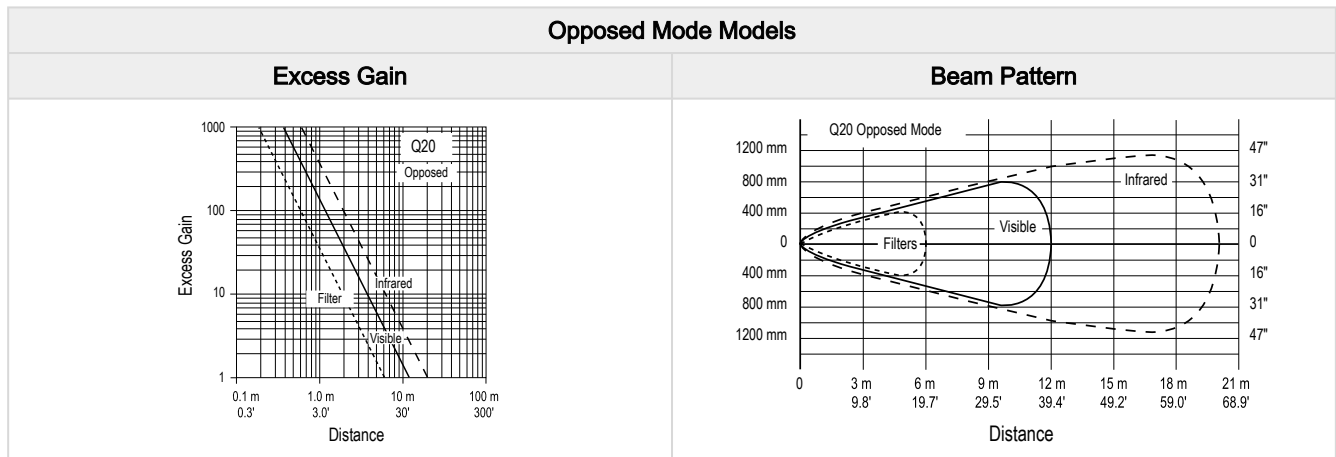

Diffuse Mode Models (based on 90% reflectance white test card)

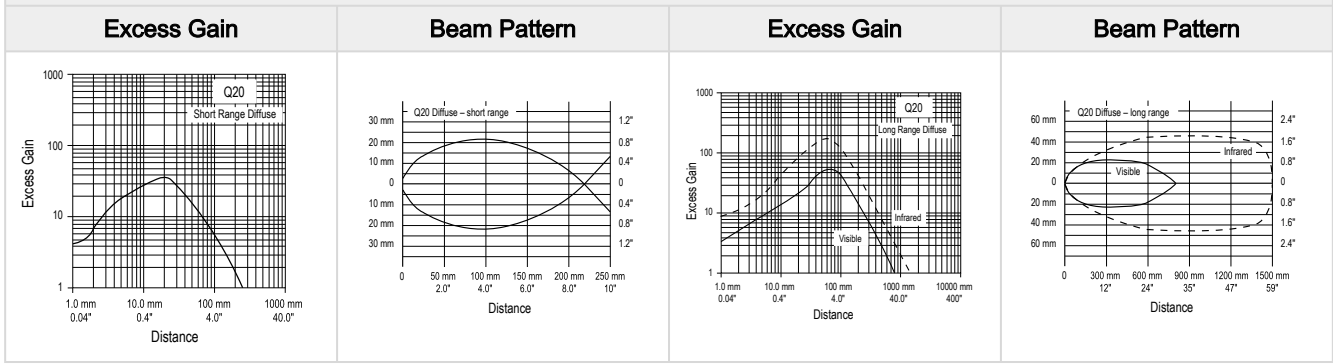

Q20DVS Models

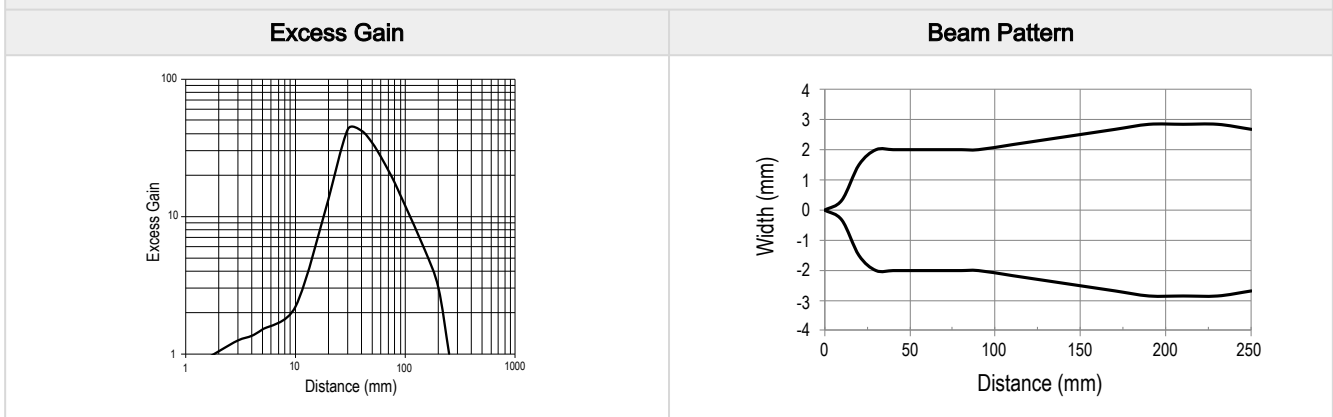

Fixed-Field Excess Gain (based on 90% reflectance white test card)

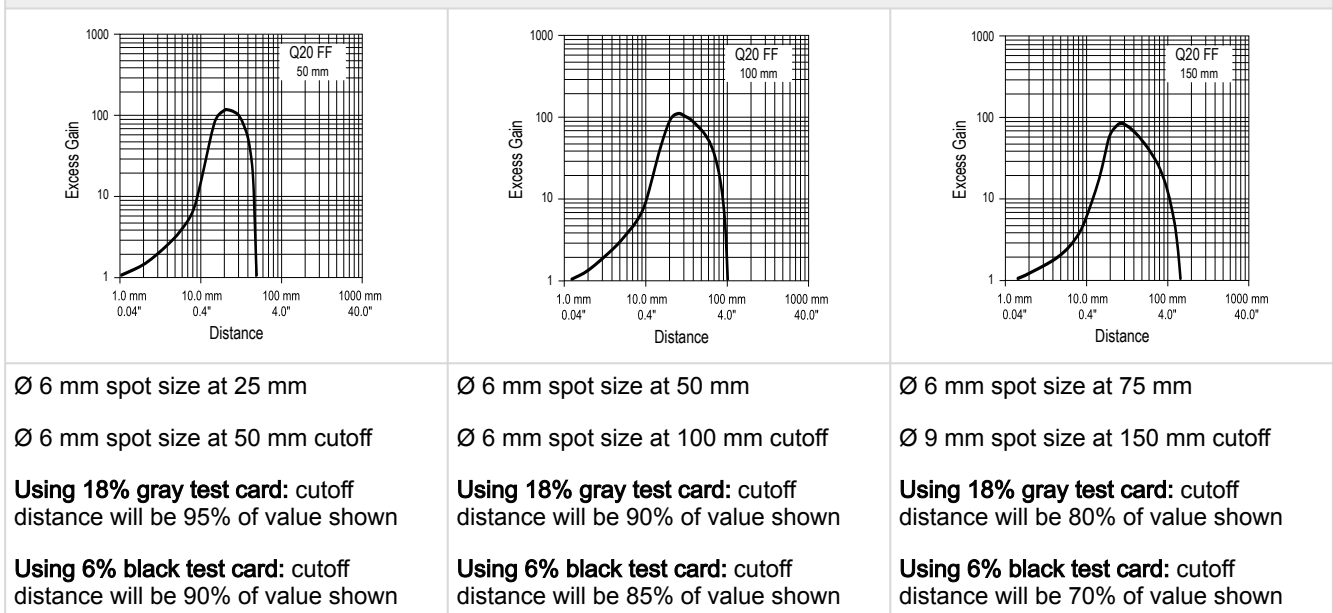

See "Accessories" on page 10 or www.bannerengineering.com for complete information.

NOTE: Polarized sensors require corner cube type retroreflective targets only.

Dimensions

All measurements are listed in millimeters [inches], unless noted otherwise. The measurements provided are subject to change.

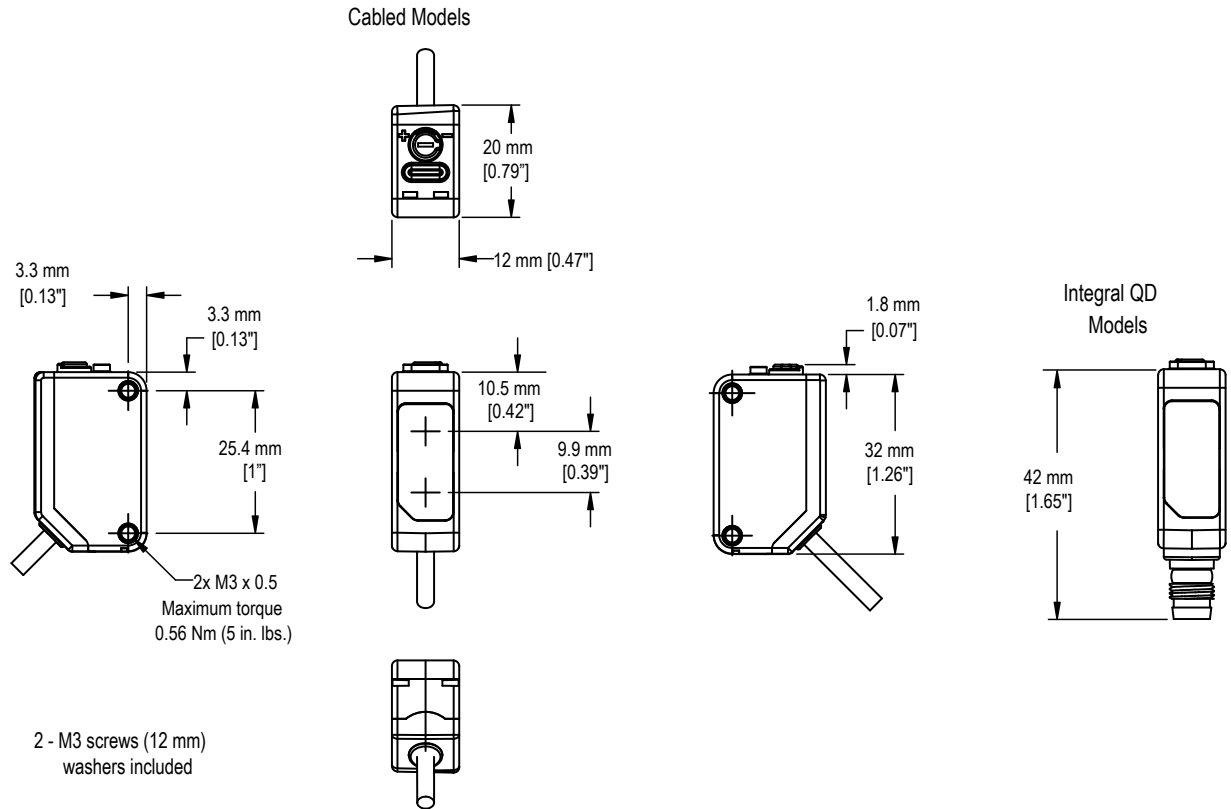

Chapter Contents

Mounting Brackets..... 10
 Cross Talk Prevention Filters..... 11
 Quick-Disconnect (QD) Cordsets..... 11
 Q20 Apertures 12

Chapter 4 Accessories

Mounting Brackets

SMBQ20L

- Sensor vertical base mount
- ±5° tip, ±7° swivel
- Stainless steel

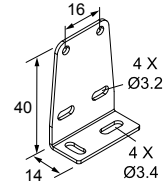

SMBQ20LV

- Sensor vertical back mount
- ±10° tip
- Stainless steel

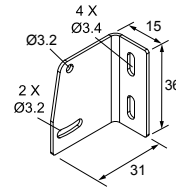

SMBQ20H

- Sensor horizontal flange mount
- ±10° swivel
- Stainless steel

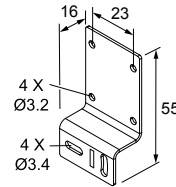

SMBQ20U

- Sensor vertical base mount with protection
- ±22.5° swivel
- Stainless steel

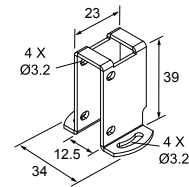

Cross Talk Prevention Filters

Model	Description		Reduced Sensor Range E/R (two apertures used)
PFQ20-H		Stainless steel (natural color)	7.5 mm (0.3 in) dia. 6.0 m (19.7 ft)
PFQ20-V		Stainless steel (colorized black)	

For visible red models only. The "H" and "V" in the model numbers refer to the polarization of the filter material. Since they are visually identical, the "H" models have been left the natural stainless steel and the "V" models have been colored black.

Quick-Disconnect (QD) Cordsets

4-Pin Single-Ended M12 Female Cordsets				
Model	Length	Style	Dimensions	Pinout (Female)
MQDC-406	2 m (6.56 ft)	Straight		
MQDC-415	5 m (16.4 ft)			
MQDC-430	9 m (29.5 ft)			
MQDC-450	15 m (49.2 ft)	Right-Angle		
MQDC-406RA	2 m (6.56 ft)			
MQDC-415RA	5 m (16.4 ft)			
MQDC-430RA	9 m (29.5 ft)			
MQDC-450RA	15 m (49.2 ft)			

1 = Brown
2 = White
3 = Blue
4 = Black
5 = Not used



4-Pin Single-Ended Snap-on M8 Female Cordsets				
Model	Length	Style	Dimensions	Pinout (Female)
PKG4-2	2.03 m (6.66 ft)	Straight		

1 = Brown
2 = White
3 = Blue
4 = Black

Continued on page 12

Continued from page 11

4-Pin Single-Ended Snap-on M8 Female Cordsets				
Model	Length	Style	Dimensions	Pinout (Female)
PKW4Z-2	2 m (6.56 ft)	Right-Angle		

4-Pin Single-Ended M8 Female Cordsets				
Model	Length	Style	Dimensions	Pinout (Female)
PKG4M-2	2 m (6.56 ft)	Straight		
PKG4M-5	5 m (16.4 ft)			
PKG4M-9	9 m (29.52 ft)			
PKW4M-2	2 m (6.56 ft)	Right Angle		
PKW4M-5	5 m (16.4 ft)			
PKW4M-9	9 m (29.5 ft)			

1 = Brown
 2 = White
 3 = Blue
 4 = Black

Q20 Apertures

Model		Reduced Sensor Range E/R (two apertures used)	Reduced Sensor Range EL/RL (two apertures used)	Description	
Circular					
APQ20-0.5	0.5 mm (0.02") dia.	0.10 m (0.33 ft)	0.18 m (0.6 ft)		
APQ20-1	1 mm (0.04") dia.	0.35 m (1.14 ft)	0.66 m (2.1 ft)		
APQ20-2	2 mm (0.08") dia.	1.5 m (4.9 ft)	2.9 m (9.5 ft)		
Vertical Slot					
APQ20-0.5V	0.5 mm (0.02") dia.	1.4 m (4.6 ft)	2.3 m (7.5 ft)		
APQ20-1V	1 mm (0.04") dia.	2.8 m (9.2 ft)	4.8 m (15.7 ft)		
APQ20-2V	2 mm (0.08") dia.	5.8 m (19.0 ft)	8.6 m (28.2 ft)		
APK-Q20	Includes two of each type				

Chapter Contents

Clean Sensor with Compressed Air Then Isopropyl Alcohol 13
Repairs 13
Contact Us 13
Banner Engineering Corp Limited Warranty 13

Chapter 5 Product Support and Maintenance

Clean Sensor with Compressed Air Then Isopropyl Alcohol

Handle the sensor with care during installation and operation. Sensor windows soiled by fingerprints, dust, water, oil, etc. create stray light that may degrade the peak performance of the sensor.

Blow dust from the sensor using filtered, compressed air. If the sensor is still dirty, gently wipe the sensor with a dry optical cloth. If the dry optical cloth does not remove all residue, use 70% isopropyl alcohol on a clean optical cloth, then dry with a clean dry optical cloth and blow with filtered, compressed air. Do not use any other chemicals for cleaning.

Repairs

Contact Banner Engineering for troubleshooting of this device. **Do not attempt any repairs to this Banner device; it contains no field-replaceable parts or components.** If the device, device part, or device component is determined to be defective by a Banner Applications Engineer, they will advise you of Banner's RMA (Return Merchandise Authorization) procedure.

IMPORTANT: If instructed to return the device, pack it with care. Damage that occurs in return shipping is not covered by warranty.

Contact Us

Banner Engineering Corp. headquarters is located at: 9714 Tenth Avenue North | Plymouth, MN 55441, USA | Phone: + 1 888 373 6767

For worldwide locations and local representatives, visit www.bannerengineering.com.

Banner Engineering Corp Limited Warranty

Banner Engineering Corp. warrants its products to be free from defects in material and workmanship for one year following the date of shipment. Banner Engineering Corp. will repair or replace, free of charge, any product of its manufacture which, at the time it is returned to the factory, is found to have been defective during the warranty period. This warranty does not cover damage or liability for misuse, abuse, or the improper application or installation of the Banner product.

THIS LIMITED WARRANTY IS EXCLUSIVE AND IN LIEU OF ALL OTHER WARRANTIES WHETHER EXPRESS OR IMPLIED (INCLUDING, WITHOUT LIMITATION, ANY WARRANTY OF MERCHANTABILITY OR FITNESS FOR A PARTICULAR PURPOSE), AND WHETHER ARISING UNDER COURSE OF PERFORMANCE, COURSE OF DEALING OR TRADE USAGE.

This Warranty is exclusive and limited to repair or, at the discretion of Banner Engineering Corp., replacement. **IN NO EVENT SHALL BANNER ENGINEERING CORP. BE LIABLE TO BUYER OR ANY OTHER PERSON OR ENTITY FOR ANY EXTRA COSTS, EXPENSES, LOSSES, LOSS OF PROFITS, OR ANY INCIDENTAL, CONSEQUENTIAL OR SPECIAL DAMAGES RESULTING FROM ANY PRODUCT DEFECT OR FROM THE USE OR INABILITY TO USE THE PRODUCT, WHETHER ARISING IN CONTRACT OR WARRANTY, STATUTE, TORT, STRICT LIABILITY, NEGLIGENCE, OR OTHERWISE.**

Banner Engineering Corp. reserves the right to change, modify or improve the design of the product without assuming any obligations or liabilities relating to any product previously manufactured by Banner Engineering Corp. Any misuse, abuse, or improper application or installation of this product or use of the product for personal protection applications when the product is identified as not intended for such purposes will void the product warranty. Any modifications to this product without prior express approval by Banner Engineering Corp will void the product warranties. All specifications published in this document are subject to change; Banner reserves the right to modify product specifications or update documentation at any time. Specifications and product information in English supersede that which is provided in any other language. For the most recent version of any documentation, refer to: www.bannerengineering.com.

For patent information, see www.bannerengineering.com/patents.

Mouser Electronics

Authorized Distributor

Click to View Pricing, Inventory, Delivery & Lifecycle Information:

[Banner Engineering:](#)

[Q20E](#) [Q20ELQ5](#) [Q20ELQ7](#) [Q20EQ](#) [Q20EQ5](#) [Q20ND](#) [Q20NDL](#) [Q20NDLQ](#) [Q20NDXL](#) [Q20NLP](#) [Q20NR](#) [Q20PD](#)
[Q20PDQ](#) [Q20PDXL](#) [Q20PDXLQ5](#) [Q20PDXLQ7](#) [Q20PFF100](#) [Q20PFF100Q](#) [Q20PFF100Q5](#) [Q20PFF150Q7](#)
[Q20PFF50](#) [Q20PLPQ](#) [Q20PLPQ5](#) [Q20PLPQ7](#) [Q20PLVQ](#) [Q20PR](#) [Q20PRLQ5](#) [Q20PRLQ7](#) [Q20PRQ](#) [Q20PRQ5](#)
[APK-Q20](#) [APQ20-0.5](#) [APQ20-0.5V](#) [APQ20-1](#) [APQ20-1.5](#) [APQ20-1V](#) [APQ20-2](#) [APQ20-2V](#) [Q20APARQ5](#)
[Q20APDLQ3](#) [Q20APDQ3](#) [Q20APFF150Q3](#) [Q20APFF50Q3](#) [Q20E W/17](#) [Q20E W/30](#) [Q20EL](#) [Q20EL W/30](#) [Q20ELQ](#)
[Q20EQ7](#) [Q20EQPMA](#) [Q20NDLQ5](#) [Q20NDLQ7](#) [Q20NDQ](#) [Q20NDQ5](#) [Q20NDQ7](#) [Q20NDVS](#) [Q20NDVS W/30](#)
[Q20NDVSQ](#) [Q20NDVSQ5](#) [Q20NDVSQ7](#) [Q20NDXL W/30](#) [Q20NDXLQ](#) [Q20NDXLQ5](#) [Q20NFF100](#) [Q20NFF100Q](#)
[Q20NFF100Q5](#) [Q20NFF100Q7](#) [Q20NFF150](#) [Q20NFF150IR](#) [Q20NFF150IRQ7](#) [Q20NFF150Q](#) [Q20NFF150Q5](#)
[Q20NFF150Q7](#) [Q20NFF50](#) [Q20NFF50 W/30](#) [Q20NFF50IR](#) [Q20NFF50IRQ7](#) [Q20NFF50Q](#) [Q20NFF50Q5](#)
[Q20NFF50Q7](#) [Q20NLPQ](#) [Q20NLPQ5](#) [Q20NLPQ7](#) [Q20NLPQMA](#) [Q20NLV](#) [Q20NLV W/30](#) [Q20NLVQ](#) [Q20NLVQ5](#)
[Q20NLVQ7](#) [Q20NR W/17](#) [Q20NR W/30](#) [Q20NRL](#) [Q20NRL W/30](#) [Q20NRLQ](#) [Q20NRLQ5](#) [Q20NRLQ7](#) [Q20NRQ](#)
[Q20NRQ5](#) [Q20NRQ7](#) [Q20PD W/30](#)