

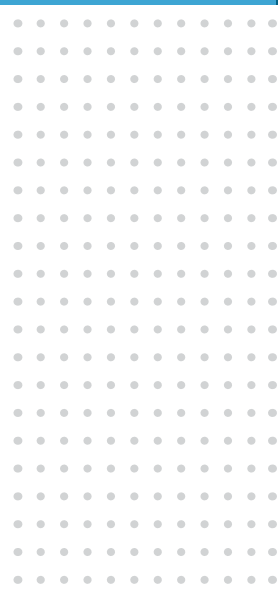

MLC Capacitors

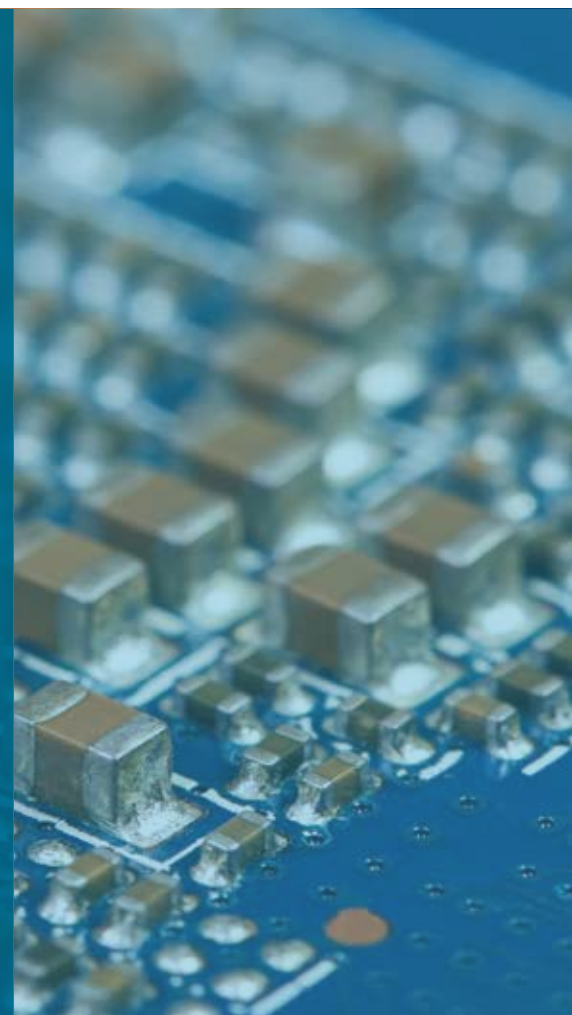

Introduction to Knowles Capacitors

At Knowles Capacitors, we make Single Layer, Multilayer, High Reliability and Precision Variable Capacitors; EMI Filters; and Thin Film Devices.

Our business was formed by combining Dielectric Laboratories, Johanson Manufacturing, Novacap, Syfer Technology and Voltronics into a single organization — each well-established specialty capacitor makers with a combined history of more than 175 years.

Our expertise is the design and manufacture of components important to engineers in applications where function and reliability are key. The markets we serve include medical implantable and medical equipment, military, aerospace/avionics, EMI and connector filtering, oil exploration, instrumentation, industrial electronics, optical networks, telecom and automotive.

We aim to be a leader in every market we serve, to the benefit of our customers and our mutual long-term success.

We achieve this by:

- Understanding our customers' real needs and providing products and services to meet and exceed them.
- Providing better products and services than competitors.
- Investing in product development, manufacturing processes and people.
- Insisting on the highest ethical standards and a business culture of trust, respect and open communication.

Products in this catalog form the basis of our ranges for "new designs." However, there are legacy products from our five brands that will still be available — we ask that you contact your local Knowles Precision Devices Sales Office for details and ordering.



Table of Contents

MLCC ORDERING INFORMATION

Product Selector	4-5
Chip Marking System	20
Ceramic Chip Capacitors — Packaging Information	21-22
Chip Dimensions & Ordering Information.....	23-26
Dielectric Information	6-9
Manufacturing Processes	10-11
Testing & Screening	12-15
Aging & Surface Mount Considerations.....	16-19

MLC CAPACITORS

Standard / AEC-Q200 MLCC Ranges	27-37
Pulse Energy	38-39
High Q, High Power RF Capacitors	40-57

SPECIAL REQUIREMENTS

High Voltage Capacitors.....	55-57, 77-78
High Reliability Capacitors	60-62, 77-82
High Temperature Capacitors	83-86
Safety Certified Capacitors	68-72

DESIGN FEATURES

Non-Magnetic Capacitors.....	73-76
Open Mode Capacitors.....	58
Tandem Capacitors	59
StackiCap™ Capacitors	63
HiTeca™ Capacitors	64-65
Leaded Standoff Capacitors	66

MLC RADIAL LEADED CAPACITORS & CAPACITOR ASSEMBLIES

Radial Leaded Capacitors	97-105
Capacitor Assemblies	87-96

SM EMI FILTERS

Surface Mount EMI Filters	106-109
---------------------------------	---------

Product Selector

Capacitors
and Filters

SM and Leaded

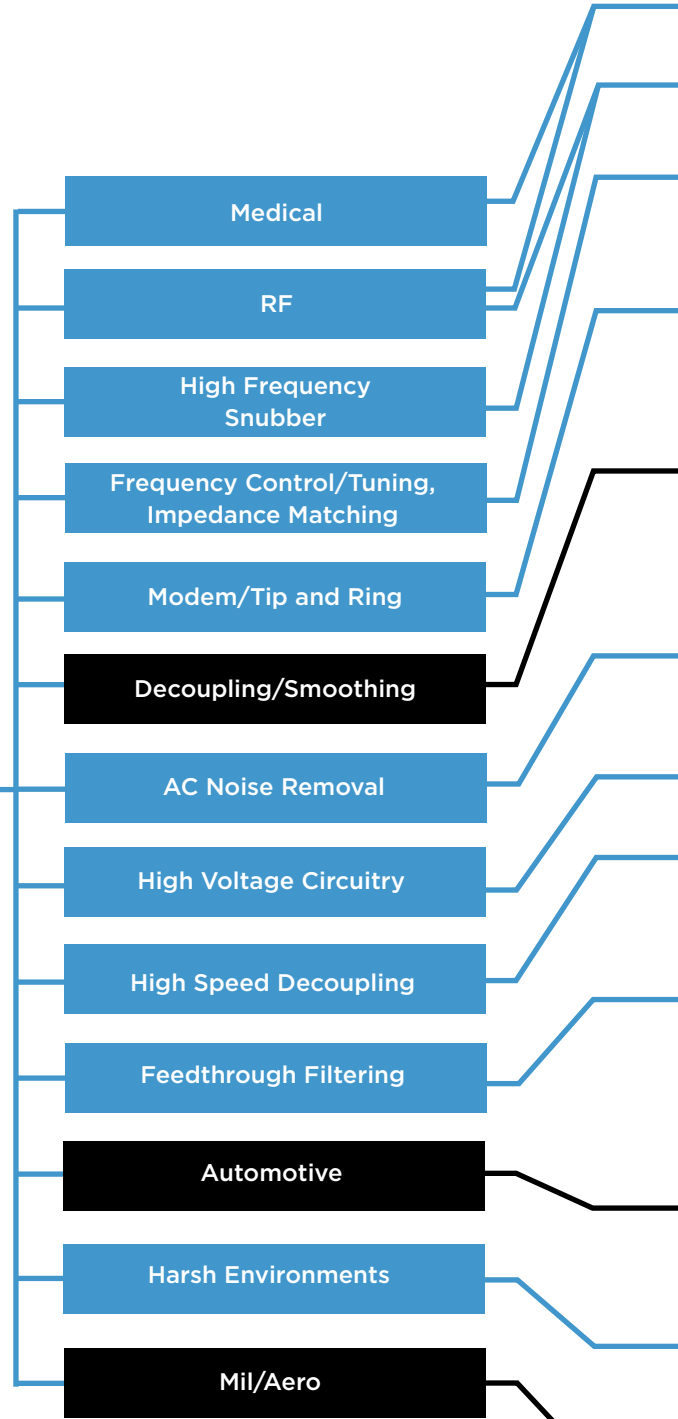

 FlexiCap™ is particularly recommended for these applications where possible.



MRI/Non-Magnetic	X7R, COG/NP0, High Q and Ultra-Low ESR 0402 to 4040 Non-Magnetic Termination 0.1pF to 6.8µF - 16V to 3kV	Pages 60-62, 78-82
Class 1 Dielectrics Low DF/ESR	High Q, COG/NP0 & Porcelain Range Ultra-Low ESR	Pages 40-54
Class 1 Dielectrics	COG/NP0 Range 0402 to 8060 0.47pF to 1µF - 10V to 12kV	Pages 27-29 and 34
High Capacitance	X7R 1812/2220/2225 100nF to 1µF - 250Vdc	Pages 30-32 and 35
Safety Certified	X7R, COG/NP0 Y2/X1, X2 Safety Certified Ranges UL/TÜV 1808/1812/2211/2215/2220	Pages 67-71
High Capacitance	X7R Range 0603 to 8060 100pF to 22µF - 16V to 12kV	Pages 30-32 and 35
Balanced Line Capacitors	X7R, E03 X2Y IPCs 0603 to 1812 150pF to 1.2µF - 16V to 1kV	Pages 104-105
Safety Certified	X7R, COG/NP0, Y2/X1, X2 Safety Certified Ranges UL/TÜV 1808/1812/2211/2215/2220	Pages 68-72
250Vac Range	X7R, COG/NP0 Ranges 250Vac Rated 50/60Hz AC	Page 67
PCB Space Saving	StackiCap™	Page 63
Low Inductance Capacitors	0505/1111/1825 Ranges X7R, COG/NP0, High Q	Pages 40-57
Capacitive	X7R and COG/NP0, E03 X2Y IPCs 0603 to 2220 10pF to 1.2µF	Pages 104-105
Capacitive/Inductive Pi	E01/E07/SBSGC/SBSMC X7R, COG/NP0 0805 to 2220 - 1A to 20A	Pages 102-103 and See EMI Filters Catalog
Filtering	SBSP/SBSG/SBSM X7R, COG/NP0 1206 to 2220 22pF to 470nF - 1A to 10A	See EMI Filters Catalog
MLCC	AEC-Q200 E03 X2Y IPCs X7R and COG/NP0 AEC-Q200 E01/E07 Feedthrough Capacitors	Pages 102-105
High Temperature	Open Mode and Tandem FlexiCap™ Capacitors With Extra Safe Electrode Design	Pages 58-59
Dipped Radial Leaded Capacitors	AEC-Q200 Ranges X7R, COG/NP0	Pages 27-37
High Reliability Capacitors and Filters	X8R Range Operational Temperature up to 150°C	Page 83-86
	Class I and II High Temperature 160°C, 200°C and 250°C	Pages 83-86
	X7R, COG/NP0 4.7pF to 22µF - 50V to 12kV	Pages 97-104
	115Vac 400Hz Range S02A/IECG-CECC/MIL-PRF/Burn in Hi Rel X2Y IPCs	Pages 60-62



Dielectric Characteristics

CLASS I DIELECTRICS

Multilayer Ceramic Capacitors are generally divided into classes, which are defined by the capacitance temperature characteristics over specified temperature ranges. These are designated by alpha-numeric codes. Code definitions are summarized below and are also available in the relevant national and international specifications.

Capacitors within this class have a dielectric constant range from 10 to 100. They are used in applications that require ultra stable

dielectric characteristics with negligible dependence of capacitance and dissipation factor with time, voltage and frequency. They exhibit the following characteristics:

- Time does not significantly affect capacitance and dissipation factor (Tan δ) – no aging.
- Capacitance and dissipation factor are not affected by voltage.
- Linear temperature coefficient.

CLASS I DIELECTRICS

	COG/NPO (1B) (Porcelain)	P90 (Porcelain)	COG/NPO (1B)	X8G	Class I High Temperature	
Dielectric classifications	-	Ultra Stable	Ultra Stable	Ultra Stable	Ultra Stable	
	IECQ-CECC	-	-	1B/CG	-	
	EIA	COG/NPO (1B)	P90	COG/NPO (1B)	X8G	
	MIL	-	-	CG (BP)	-	
Ordering code	DLI	CF	AH	-	-	
	Novacap	-	-	N, RN	-	
	Syfer	-	-	Q, U	C	
	Voltronics	F	H	Q	-	
Rated temperature range	-	-55°C to +125°C	-55°C to +125°C	-55°C to +125°C	-55°C to +150°C	
Maximum capacitance change over temperature range	No DC voltage applied	0 ± 15 ppm/°C	+90 ± 20 ppm/°C	0 ± 30 ppm/°C	0 ± 30 ppm/°C	
	Rated DC voltage applied	-				
Tangent of loss angle (tan δ)	-	≤0.0005 @1MHz	≤0.0005 @1MHz	>50pF ≤0.0015 ≤50pF 0.0015 (15/Cr + 0.7)	≤0.0005 @1MHz	
Insulation resistance (Ri)	Time constant (Ri x Cr)	@25°C = 10 ⁶ MΩ min @125°C = 10 ⁵ MΩ min	100GΩ or 1000s (whichever is the least)		@25°C = 100GΩ or 1000ΩF @160°C & 200°C = 1GΩ or 100ΩF (whichever is the least)	
Capacitance tolerance	Cr <4.7pF	±0.05pF, ±0.10pF, ±0.25pF, ±0.5pF				
	Cr ≥ 4.7 to <10pF	±0.10pF, ±0.25pF, ±0.5pF				
	Cr ≥ 10pF	±1%, ±2%, ±5%, ±10%				
Dielectric strength. Voltage applied for 5 seconds. Charging current limited to 50mA maximum.	≤200V	2.5 times	2.5 times	2.5 times		
	>200V to <500V			Rated voltage +250V		
	500V to ≤ 1kV			1.5 times		
	>1kV to ≤ 1.2kV			1.25 times		
	>1.2kV		N/A	1.2 times		
Climatic category (IEC)	Chip	-	-	55/125/56	-	
	Dipped	-	-	-	55/125/21	
	Discoidal	-	-	-	55/125/56	
Aging characteristic (Typical)	-	Zero				
Approvals	Syfer Chip	-	-	-	QC-32100	

Note: exact specification may differ for individual part numbers – refer to detailed datasheet for exact specification. In most cases this is available to download direct from our website.



Dielectric Characteristics

CLASS II DIELECTRICS

Capacitors of this type have a dielectric constant range of 1000-4000 and also have a nonlinear temperature characteristic that exhibits a dielectric constant variation of less than $\pm 15\%$ (2R1) from its room temperature value, over the specified temperature range. Generally used for bypassing (decoupling), coupling, filtering, frequency discrimination, DC blocking and voltage transient suppression with greater volumetric efficiency than Class I units, while maintaining stability within defined limits.

Capacitance and dissipation factors are affected by:

- a) Time (Aging)
- b) Voltage (AC or DC)
- c) Frequency

CLASS II DIELECTRICS

X5R	X7R (2R1)			X8R	Class II High Temperature			Hiteca™			
Stable	Stable			Stable	Stable			Improved Stability	-	Dielectric classifications	
-	2C1	2R1	2X1	-	-			-	IECQ-CECC		
X5R	-	X7R (2R1)	-	X8R	-			Hiteca™	EIA		
-	BZ	-	BX	-	-			-	MIL		
-	-			-	-			-	DLI	Ordering code	
BW	-	B, RB	X	S	G	E, RE		-	Novacap		
P	R	X	B	N	-	X		Z	Syfer		
-	-	X	-	-	-	-		-	Voltronics		
-55°C to +85°C	-55°C to +125°C			-55°C to +150°C	-55°C to +160°C	-55°C to +200°C		-55°C to +125°C	-	Rated temperature range	
$\pm 15\%$	$\pm 15\%$	$\pm 15\%$	$\pm 15\%$	$\pm 15\%$	+15 -40%	+15 -65%		$\pm 15\%$	No DC voltage applied	Maximum capacitance change over temperature range	
-	+15 -45%	-	+15 -25%	-	-			-	Rated DC voltage applied		
≤ 0.025 Typical*	$>25V \leq 0.025$ $\leq 25V \leq 0.035$			≤ 0.025	≤ 0.025			≤ 0.01	-	Tangent of loss angle (tan δ)	
100G Ω or 1000s (whichever is the least)									Time constant (Ri x Cr)	Insulation resistance (Ri)	
$\pm 5\%, \pm 10\%, \pm 20\%$									-	Capacitance tolerance	
2.5 times									$\leq 200V$	Dielectric strength. Voltage applied for 5 seconds.	
Rated voltage +250V									$>200V$ to $<500V$		
1.5 times									500V to $<1kV$	Charging current limited to 50mA maximum.	
1.2 times									$\geq 1kV$		
55/85/56	55/125/56			55/150/56	-			55/125/56	Chip	Climatic category (IEC)	
-	55/125/21			-	-			-	Dipped		
-	55/125/56			-	-			-	Discoidal		
5% Typical	$<2\%$ per time decade								Zero	-	Aging characteristic (Typical)
-	QC-32100	-			-	QC-32100	-		-	Syfer chip	Approvals

* Refer to the MLC Capacitors catalog for details of Dissipation Factor.

Note: exact specification may differ for individual part numbers – refer to detailed datasheet for exact specification. In most cases this is available to download direct from our website.



Dielectric Characteristics

TYPICAL DIELECTRIC TEMPERATURE CHARACTERISTICS

Porcelain COG/NP0 (1B) and P90

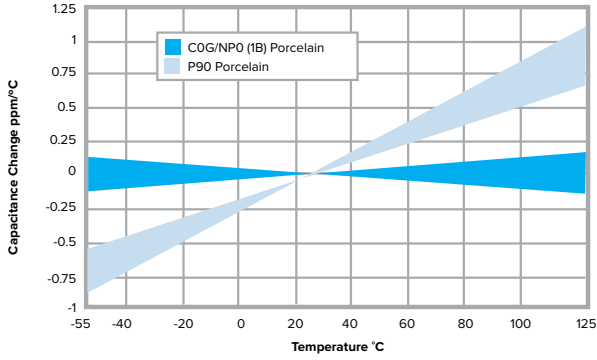

Family	Dielectric Characteristics	Temperature Range
AH	P90 +90/ ± 20	-55°C/+125°C
CF	COG/NP0 0 ± 15	-55°C/+125°C
UL	COG/NP0 0 ± 30	-55°C/+125°C

COG/NP0 (1B)

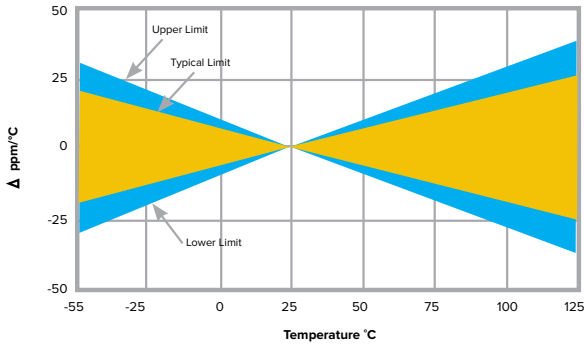

X7R (2R1)

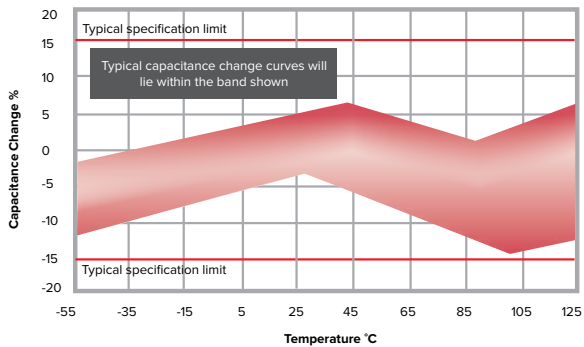

IMPEDANCE vs. FREQUENCY

Ultra Stable COG/NP0 (1B) Dielectric

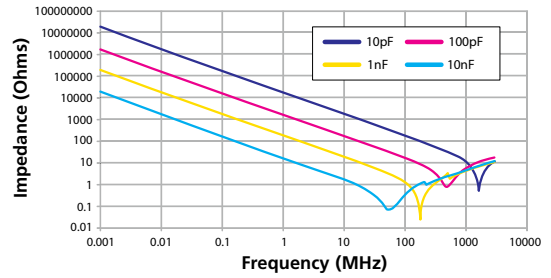

Stable X7R Dielectric

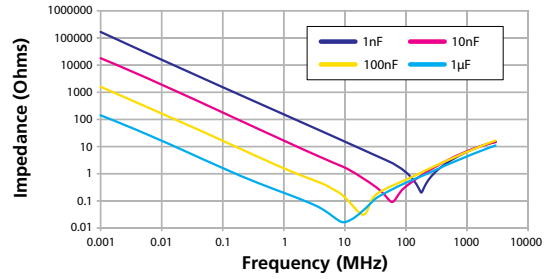

Stable X7R Dielectric – 10nF

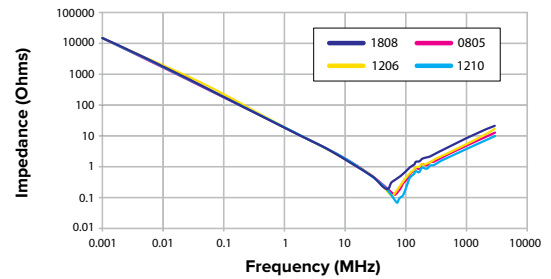

ESR vs. FREQUENCY – CHIPS

Ultra Stable COG/NP0 Dielectric

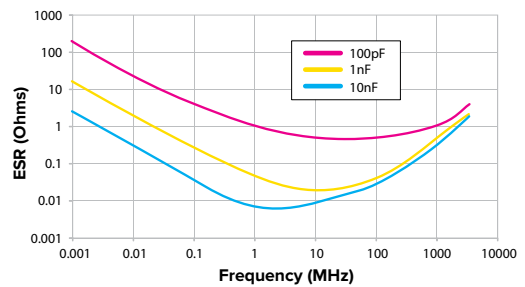

Stable X7R Dielectric

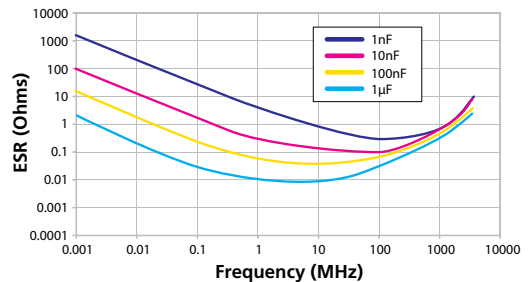

Dielectric Termination Combinations

		Palladium Silver	Palladium Silver	Nickel Barrier (100% matte tin plating) Lead free	Nickel Barrier 90/10% tin/lead	Nickel Barrier Gold flash	FlexiCap™ with Nickel Barrier 100% tin	FlexiCap™ with Nickel Barrier 90/10% tin/lead	FlexiCap™ with Copper Barrier 100% tin	FlexiCap™ Ag Layer, 400-u-in Cu Barrier 200-u-in Sn Plate	FlexiCap™ with Copper Barrier 90/10% tin/lead	Copper Barrier 100% tin	Ag Layer, 400-500-u-in Cu Barrier, 200-u-in 90/10 Sn Plate	Copper Barrier 90/10% tin/lead	Solderable Silver	Solderable Palladium Silver	Ag termination, Ni Barrier, Heavy SnPb Plated Solder	Ag termination, Enhanced Ni Barrier, Sn Plated Solder	Ag termination, Enhanced Cu Barrier, Sn Plated Solder	Ag Termination, Cu Barrier Layer, Heavy SnPb Plated Solder	
		RoHS	RoHS	RoHS	RoHS	RoHS	RoHS	RoHS	RoHS	RoHS	RoHS	RoHS	RoHS	RoHS	RoHS	RoHS	RoHS	RoHS	RoHS	RoHS	
NPO Porcelain - Hi Q				●	●		●	●	●	●	●	●	●	●	●	●	●	●	●	●	●
NPO Porcelain - Hi Q		●	●			●															
Termination ordering code	DLI	-	P	Z	U	S	Q	Y	M	-	-	W	-	V	-	-	T	E	H	R	
	Novacap	P	PR	N	Y	NG	C	D	-	-	-	B	-	E	S	K	-	-	-	-	
	Syfer	-	F	J	A	-	Y	H	3	-	5	2	-	4	-	-	-	-	-	-	
	Voltronics	-	S	-	-	-	-	-	3	M	-	2	W	-	-	-	-	-	-	-	
Dielectric	Code																				
NPO Porcelain - Hi Q	DLI - CF		●	●	●	●	●	●	●			●		●			●	●	●	●	
P90 Porcelain - Hi Q	DLI - AH		●	●	●	●	●	●	●			●		●			●	●	●	●	
COG - Hi Q/Low ESR	Syfer - Q, U			●	●																
COG - Hi Q/Low ESR BME	Syfer - H			●																	
COG/NPO	Novacap - N/RN	●	●	●	●	●	●	●							●	●					
	Syfer - A			●	●		●	●													
	Syfer - C, F		●	●	●		●	●													
COG/NPO - BME	Syfer - G, K			●	●		●	●													
COG/NPO - Non-Mag	Novacap - M	●	●									●		●		●					
	Syfer - C, Q								●		●	●		●							
	Voltronics - Q		●							●		●	●								
X5R	Syfer - P		●	●	●		●	●													
	Novacap - BW			●	●	●															
X7R	Novacap - B/RB	●	●	●	●	●	●	●							●	●					
	Syfer - E						●	●													
	Syfer - X, D		●	●	●		●	●													
X7R - BME	Novacap - BB			●	●	●															
	Syfer - J			●			●	●													
	Syfer - S						●	●													
BX	Novacap - X	●	●	●	●	●	●	●							●	●					
	Syfer - B		●	●	●		●	●													
BZ	Syfer - R		●	●	●		●	●													
X7R - Non-Mag	Novacap - C	●	●									●		●		●					
	Syfer - X								●		●			●							
	Voltronics - X		●						●	●			●								
X8R	Novacap - S	●	●	●	●		●	●							●	●					
	Syfer - N		●	●	●		●	●													
	Syfer - T						●	●													
COG/NPO (160°C)	Novacap - F	●	●	●	●		●	●							●	●					
COG/NPO (200°C)	Novacap - D														●	●					
COG/NPO (200°C)	Novacap - RD			●																	
	Syfer - G			●																	
Class II (160°C)	Novacap - G	●	●	●	●		●	●							●	●					
Class II (200°C)	Novacap - E														●	●					
	Novacap - RE			●																	
	Syfer - X			●																	
Hiteca	Syfer - Z						●														
	Syfer - Y						●														

Dielectric codes in Red — AEC-Q200 qualified. Dielectric codes in Green — IECQ-CECC.

FlexiCap™ Overview

FLEXICAP™ TERMINATION

MLCCs are widely used in electronic circuit design for a multitude of applications. Their small package size, technical performance and suitability for automated assembly make them the component of choice for the specifier.

However, despite the technical benefits, ceramic components are brittle and need careful handling on the production floor. In some circumstances they may be prone to mechanical stress damage if not used in an appropriate manner. Board flexing, depanelization, mounting through hole components, poor storage and automatic testing may all result in cracking.

Careful process control is important at all stages of circuit board assembly and transportation — from component placement to test and packaging. Any significant board flexing may result in stress fractures in ceramic devices that may not always be evident during the board assembly process. Sometimes it may be the end customer who finds out — when equipment fails!

KNOWLES HAS THE SOLUTION — FLEXICAP™

FlexiCap™ has been developed as a result of listening to customers' experiences of stress damage to MLCCs from many manufacturers, often caused by variations in production processes. Our answer is a proprietary flexible epoxy polymer termination material that is applied to the device under the usual nickel barrier finish. FlexiCap™ will accommodate a greater degree of board bending than conventional capacitors.

FLEXICAP™ TERMINATION

Ranges are available with FlexiCap™ termination material offering increased reliability and superior mechanical performance (board flex and temperature cycling) when compared with standard termination materials. Refer to Knowles application note reference AN0001. FlexiCap™ capacitors enable the board to be bent almost twice as much before mechanical cracking occurs. Refer to application note AN0002. FlexiCap™ is also suitable for Space applications having passed thermal vacuum outgassing tests. Refer to Syfer application note reference AN0026.

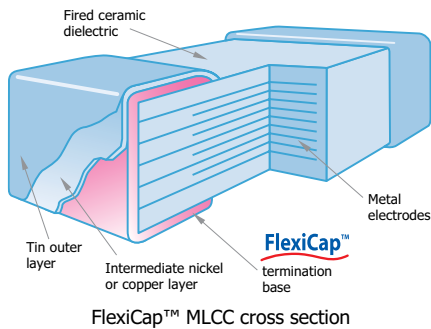

FLEXICAP™ BENEFITS

With traditional termination materials and assembly, the chain of materials from bare PCB to soldered termination provides no flexibility. In circumstances where excessive stress is applied, the weakest link fails. This means the ceramic itself, which may fail short-circuit.

The benefit to the user is to facilitate a wider process window — giving a greater safety margin and substantially reducing the typical root causes of mechanical stress cracking. FlexiCap™ may be soldered using your traditional wave or reflow solder techniques including, lead free, and needs no adjustment to equipment or current processes.

Knowles has delivered millions of FlexiCap™ components, and during that time has collected substantial test and reliability data, working in partnership with customers worldwide, to eliminate mechanical cracking. An additional benefit of FlexiCap™ is that MLCCs can withstand temperature cycling -55°C to +125°C in excess of 1,000 times without cracking. FlexiCap™ termination has no adverse effect on any electrical parameters, nor affects the operation of the MLCC in any way.



- Picture taken at 1,000x magnification using a SEM to demonstrate the fibrous nature of the FlexiCap™ termination that absorbs increased levels of mechanical stress.

AVAILABLE ON THE FOLLOWING:

- All High Reliability Ranges
- Standard and High Voltage Capacitors
- Open Mode and Tandem Capacitors
- Safety Certified Capacitors
- Non-Magnetic Capacitors
- 3-terminal EMI Chips
- X2Y Integrated Passive Components
- X8R High Temperature Capacitors

SUMMARY OF PCB BEND TEST RESULTS

The bend tests conducted on X7R have proven that the FlexiCap™ termination withstands a greater level of mechanical stress before mechanical cracking occurs. The AEC-Q200 test for X7R requires a bend level of 2mm minimum and a cap change of less than 10%. Knowles tests to a minimum bend of 5mm for X7R with FlexiCap™ termination and for COG with either FlexiCap™ or standard termination.

Product X7R (2R1)	Typical bend performance under AEC-Q200 test conditions
Standard termination	2mm to 3mm
FlexiCap™	Typically 8mm to 10mm

APPLICATION NOTES

FlexiCap™ may be handled, stored and transported in the same manner as standard terminated capacitors. The requirements for mounting and soldering FlexiCap™ are the same as for standard SMD capacitors. For customers currently using standard terminated capacitors, there should be no requirement to change the assembly process when converting to FlexiCap™. Based upon board bend tests in accordance with IEC 60384-1, the amount of board bending required to mechanically crack a FlexiCap™ terminated capacitor is significantly increased compared with standard terminated capacitors. It must be stressed, however, that capacitor users must not assume that the use of FlexiCap™ terminated capacitors will totally eliminate mechanical cracking. Good process controls are still required for this objective to be achieved.



Manufacturing Processes

PRODUCTION PROCESS FLOWCHART

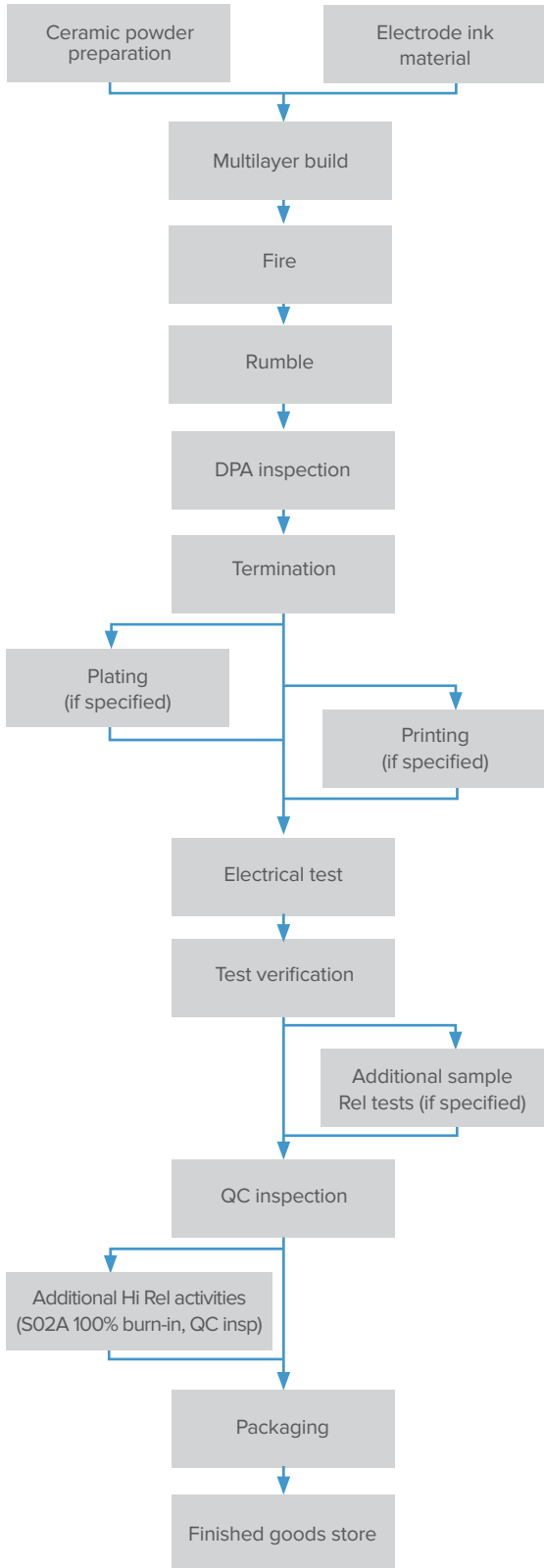

KNOWLES RELIABILITY GRADES

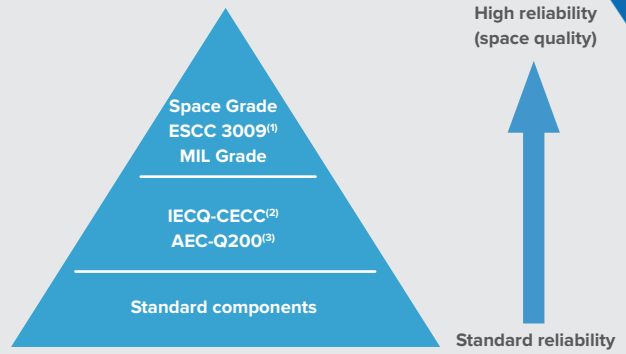

Notes:

1) Space grade tested in accordance with ESCC3009 (refer to Knowles Spec S02A 0100) or MIL Grade (in accordance with MIL-PRF-123, MIL-PRF-55681).

2) IECQ-CECC. The International Electrotechnical Commission (IEC) Quality Assessment System for Electronic Components. This is an internationally recognized product quality certification that provides customers with assurance that the product supplied meets high-quality standards. View Knowles IECQ-CECC approvals at iecq.org or at knowlesc capacitors.com

3) AEC-Q200. Automotive Electronics Council Stress Test Qualification For Passive Components. Refer to Knowles application note reference AN0009.

KNOWLES RELIABILITY SURFACE MOUNT PRODUCT GROUPS

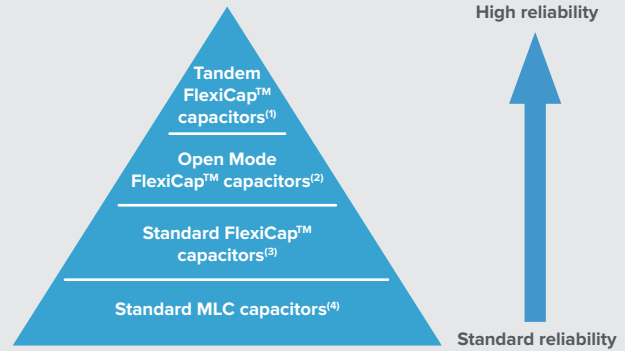

Notes:

1) "Tandem" construction capacitors, i.e., internally having the equivalent of 2 series capacitors. If one of these should fail short-circuit, there is still capacitance end to end and the chip will still function as a capacitor, although capacitance may be affected. Refer to application note AN0021. Also available qualified to AEC-Q200.

2) "Open Mode" capacitors with FlexiCapTM termination also reduce the possibility of a short-circuit by utilizing inset electrode margins. Refer to application note AN0022. Also available qualified to AEC-Q200.

3) Multilayer capacitors with Knowles FlexiCapTM termination. By using FlexiCapTM termination, there is a reduced possibility of the mechanical cracking occurring.

4) "Standard" capacitors include MLCCs with tin finish over nickel but no FlexiCapTM.



Testing

TESTS CONDUCTED DURING BATCH MANUFACTURE

KNOWLES RELIABILITY SM PRODUCT GROUP

	Standard SM capacitors	IECQ-CECC/MIL grade	AEC-Q200	S (Space grade) High Rel S02A ESCC 3009 MIL-PRF-123
Solderability	●	●	●	●
Resistance to soldering heat	●	●	●	●
Plating thickness verification (if plated)	●	●	●	●
Destructive Physical Analysis (DPA)	●	●	●	●
Voltage proof test (DWV/Flash)	●	●	●	●
Insulation resistance	●	●	●	●
Capacitance test	●	●	●	●
Dissipation factor test	●	●	●	●
100% visual inspection	○	○	●	●
100% burn-in (2xRV @125°C for 168 hours)	○	○	○	●
Load sample test @ 125°C	○	○	●	LAT1 & LAT2 (1,000-hours)
Humidity sample test @ 85°C/85% RH	○	○	●	240 hours
Hot IR sample test	○	○	○	○
Axial pull sample test (MIL-STD-123)	○	○	○	○
Breakdown voltage sample test	○	○	○	○
Deflection (bend) sample test	○	○	○	○
Scanning Acoustic Microscop (SAM)	○	○	○	○
LAT1 (4 x adhesion, 8 x rapid temp change + LAT2 and LAT3)	-	-	-	○
LAT2 (20 x 1,000-hour life test + LAT3)	-	-	-	○
LAT3 (6 x TC and 4 x solderability)	-	-	-	○

● Test conducted as standard.

○ Optional test. Please discuss with the Sales Office.



IECQ-CECC and AEC-Q200 — Periodic Tests

PERIODIC TESTS CONDUCTED FOR IECQ-CECC AND AEC-Q200

Test ref	Test	Termination type	Additional requirements	Sample acceptance			Reference
				P	N	C	
P1	High temperature exposure (storage)	All types	Un-powered. 1,000 hours @ T=150°C. Measurement at 24 ± 2 hours after test conclusion.	12	77	0	MIL-STD-202 Method 108
P2	Temperature cycling	COG: All types X7R: Y & H only	1,000 cycles -55°C to +125°C Measurement at 24 ± 2 hours after test conclusion.	12	77	0	JESD22 Method JA-104
P3	Moisture resistance	All types	T = 24 hours/cycle. Note: Steps 7a and 7b not required. Unpowered. Measurement at 24 ± 2 hours after test conclusion.	12	77	0	MIL-STD-202 Method 106
P4	Biased humidity	All types	1,000 hours 85°C/85%RH. Rated voltage or 50V whichever is the least and 1.5V. Measurement at 24 ± 2 hours after test conclusion.	12	77	0	MIL-STD-202 Method 103
P5	Operational life	All types	Condition D steady state TA=125°C at full rated. Measurement at 24 ± 2 hours after test conclusion.	12	77	0	MIL-STD-202 Method 108
P6	Resistance to solvents	All types	Note: Add aqueous wash chemical. Do not use banned solvents.	12	5	0	MIL-STD-202 Method 215
P7	Mechanical shock	COG: All types X7R: Y & H only	Figure 1 of Method 213. Condition F	12	30	0	MIL-STD-202 Method 213
P8	Vibration	COG: All types X7R: Y & H only	5g's for 20 minutes, 12 cycles each of 3 orientations. Note: Use 8" x 5" PCB 0.031" thick 7 secure points on one long side and 2 secure points at corners of opposite sides. Parts mounted within 2" from any secure point. Test from 10-2,000Hz.	12	30	0	MIL-STD-202 Method 204
P9	Resistance to soldering heat	All types	Condition B, no pre-heat of samples: Single wave solder - Procedure 2	12	12	0	MIL-STD-202 Method 210
P10	Thermal shock	COG: All types X7R: Y & H only	-55°C/+125°C. Number of cycles 300. Maximum transfer time - 20 seconds, dwell time - 15 minutes. Air-Air.	12	30	0	MIL-STD-202 Method 107
P11	Adhesion, rapid temp change and climatic sequence	COG: All types (Class I)	5N force applied for 10s, -55°C/+125°C for 5 cycles, damp heat cycles	12	27	0	BS EN 60384-21 Clause 8.8, 8.12 & 8.13
		X7R: A, F & J only (Class II)					BS EN 60384-22 Clause 8.8, 8.12 & 8.13
P12	Board flex	COG: All types X7R: Y & H only	3mm deflection Class I 2mm deflection Class II	12	30	0	AEC-Q200-005
P13		X7R: A, F & J only (Class II)	1mm deflection	12	12	0	BS EN 60384-22 Clause 8.9
P14	Terminal strength	All types	Force of 1.8kg for 60 seconds	12	30	0	AEC-Q200-006
P15	Beam load test	All types	-	12	30	0	AEC-Q200-003
P16	Damp heat steady state	All Types (Class I & II)	56 days, 40°C/93% RH 15x no volts, 15x 5Vdc, 15x rated voltage or 50V whichever is the least	12	45	0	BS EN 60384-21 Clause 8.14
							BS EN 60384-22 Clause 8.14

Test results are available on request.

P = Period in months. N = Sample size. C = Acceptance criteria.



High Reliability Testing

Our High Rel products are designed for optimum reliability and are burned in at elevated voltage and temperature levels. They are 100% electrically inspected to ascertain conformance to a strict performance criteria.

Applications for High Reliability products include medical implanted devices, aerospace, airborne, various military applications and consumer uses requiring safety margins not attainable with conventional product.

We have the ability to test surface mount and leaded capacitors to High Reliability standards as detailed below, or to customer SCD. Military performance specifications are designed and written for the voltage/capacitance ratings of the individual product slash numbers associated with the specification.

Some of the requirements of the military document may not apply to the High Reliability product. The following details the intent of the individual military specifications available for test and the deviations that may apply. Product voltage ratings outside of the intended military specification will follow the voltage test potential outlined. Contact the Sales Office with any requirements or deviations that are not covered here.

ENVIRONMENTAL TESTING

We also have the capability to perform all the Environmental Group B, Group C and Qualification testing to the referenced military specifications.

Testing abilities include the following:

- Nondestructive internal examination
- Destructive physical analysis
- Radiographic inspection
- Terminal strength
- Resistance to soldering heat
- Voltage-temperature limits
- Temperature coefficient
- Moisture resistance
- Humidity, steady state, low voltage
- Vibration
- Resistance to solvents
- Life
- Thermal shock and immersion
- Low temperature storage
- Barometric pressure
- Shock, specified pulse
- Mechanical shock
- Constant acceleration
- Wire bond evaluation
- Partial discharge (corona)
- 200°C Voltage Conditioning

MILITARY PERFORMANCE SPECIFICATIONS

MIL-PRF-55681 (GROUP A)

General purpose military high reliability specification for surface mount sizes 0805 through 2225 in 50V and 100V.

- VOLTAGE CONDITIONING
- 100 HRS, 2X VDCW, 125°C
- DWV, IR, 125°C IR, CAP, DF TEST
- VISUAL & MECH. INSPECTION (AQL SAMPLE PLAN)
- SOLDERABILITY, SAMPLE 13(0)
- 8% PDA MAXIMUM

MIL-PRF-123 (GROUP A)

The specification affords an increased reliability level over MIL-PRF-55681 for space, missile and other high reliability applications such as medical implantable or life support equipment. The specification covers surface mount sizes 0805 through 2225 in 50V rating and various radial/axial leaded products in 50V, 100V and 200V ratings.

- THERMAL SHOCK, 20 CYCLES
- VOLTAGE CONDITIONING 168/264 HRS, 2X VDCW, 125°C
- DWV, IR, 125°C IR, CAP, DF TEST
- VISUAL & MECH. INSPECTION SAMPLE 20(0)
- DPA⁽¹⁾
- PDA, 3% (0.1%), 5% (0.2%) MAX⁽²⁾

MIL-PRF-39014 (GROUP A)

The specification covers general military purpose radial/axial leaded and encapsulated products in 50V, 100V and 200V ratings.

- THERMAL SHOCK, 5 CYCLES
- VOLTAGE CONDITIONING 96 HRS, 2X VDCW, 125°C
- DWV, IR, 125°C IR, CAP, DF TEST
- VISUAL & MECH. INSPECTION (AQL SAMPLE PLAN)
- SOLDERABILITY, SAMPLE 13(0)
- 8% PDA MAXIMUM

MIL-PRF-49467 (GROUP A)

General purpose military high reliability specification for radial leaded epoxy coated products. The specification covers sizes 1515 through 13060 with 600V, 1kV, 2kV, 3kV, 4kV and 5kV ratings.

- THERMAL SHOCK, 5 CYCLES
- VOLTAGE CONDITIONING 96 HRS, RATED VDCW, 125°C
- PARTIAL DISCHARGE (OPTION)⁽³⁾
- DWV, IR, 125°C IR, CAP, DF TEST
- VISUAL & MECH. INSPECTION SAMPLE 13(0)
- SOLDERABILITY, SAMPLE 5(0)
- 10% PDA MAXIMUM

MIL-PRF-49470 (DSCC 87106) (GROUP A)

General purpose military high reliability specification for stacked and leaded capacitors for switch mode power supplies. The specification covers sizes 2225 through 120200 in 50V, 100V, 200V and 500V ratings.

- THERMAL SHOCK, 5 CYCLES
- VOLTAGE CONDITIONING 96 HRS, 2X VDCW⁽⁴⁾, 125°C
- DWV, IR, 125°C IR, CAP, DF TEST
- VISUAL & MECH. INSPECTION SAMPLE 13(0)
- SOLDERABILITY, SAMPLE 5(0)
- 10% PDA MAXIMUM

MIL-PRF-38534 (GROUP A)

Specification for Hybrid Microcircuits with a section for Element Evaluation on passive components. There are two classification levels of reliability. Class H is for a standard military quality level. Class K is for the highest reliability level intended for space application. Knowles will perform a 100-hour burn-in on all Class K products and assumes Class K Subgroup 3 samples will be unmounted and Subgroup 4 (wirebond) shall not apply unless otherwise stated.

TEST VOLTAGE (VDC)

This test potential shall be used on all High Reliability Testing unless otherwise specified.

*V/C Is Voltage Conditioning.

WVDC	DWV	V/C*
<200	2.5X Rated	2.0X Rated
250	500V	400V
300	500V	400V
400	600V	500V
500	750V	600V
600	750V	600V
>700	1.2X Rated	1.0X Rated

Notes:

1. MIL-PRF-123 DPA shall be per TABLE XIV AQL requirements unless otherwise specified.
2. MIL-PRF-123 allowable PDA shall be 3% overall and 0.1% in the last 48 hours for capacitance/voltage values listed in MIL-PRF-123, and be 5% overall and 0.2% in the last 48 hours for capacitance/voltage values beyond MIL-PRF-123.
3. MIL-PRF-49467 standard Group A is without Partial Discharge. Partial Discharge test is optional and must be specified.
4. MIL-PRF-49470 (DSCC 87106) 500V rated product has Voltage Conditioning at 1.2X VDCW.



Regulations and Compliance

RELEASE DOCUMENTATION

	Knowles reliability SM product group			
	Standard SM capacitors	IECQ-CECC	AEC-Q200 MIL grade	S (Space grade) High Rel S02A
Certificate of conformance	●	-	●	●
IECQ-CECC Release certificate of conformity	-	●	-	-
Batch electrical test report	○	○	○	Included in data pack
S (space grade) data documentation package	-	-	-	●

- Release documentation supplied as standard.
- Original documentation.

PERIODIC TESTS CONDUCTED AND RELIABILITY DATA AVAILABILITY

STANDARD SURFACE MOUNT CAPACITORS

Components are randomly selected on a sample basis and the following routine tests are conducted:

- Load Test. 1,000 hours @125°C (150°C for X8R). Applied voltage depends on components tested.
- Humidity Test. 168 hours @ 85°C/85% RH.
- Board Deflection (bend test).

Test results are available on request.

CONVERSION FACTORS

From	To	Operation
FITS	MTBF (hours)	$10^9 \div \text{FITS}$
FITS	MTBF (years)	$10^9 \div (\text{FITS} \times 8760)$

FITS = Failures in 10^9 hours.
MTBF = Mean time between failures.

EXAMPLE OF FIT (FAILURE IN TIME) DATA AVAILABLE:

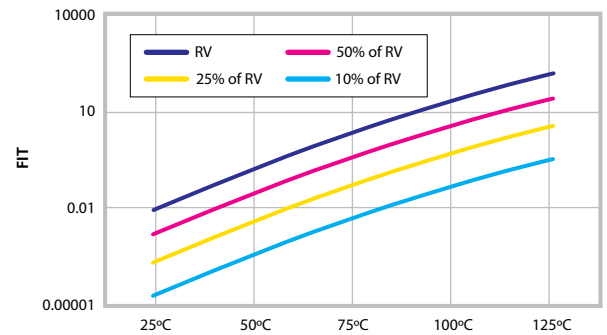

Component type: 0805 (C0G/NP0 and X7R).
Testing location: Knowles reliability test department.
Results based on: 16,622,000 component test hours.

REGISTRATION, EVALUATION, AUTHORIZATION AND RESTRICTION OF CHEMICALS (REACH)

The main purpose of REACH is to improve the protection of human health and the environment from the risks arising from the use of chemicals. Knowles maintains both ISO14001 Environmental Management System and OHSAS 18001 Health and Safety Management System approvals that require and ensure compliance with corresponding legislation such as REACH. For further information, please contact the Knowles Precision Devices Sales Office at knowlesc capacitors.com

ROHS COMPLIANCE

Knowles routinely monitors worldwide material restrictions (e.g., EU/China and Korea RoHS mandates) and is actively involved in shaping future legislation. All standard C0G/NP0, X7R, X5R and High Q Knowles MLCC products are compliant with the EU RoHS directive (see below for special exceptions) and those with plated terminations are suitable for soldering using common lead-free solder alloys (refer to "Soldering Information" for more details on soldering limitations). Compliance with the EU RoHS directive automatically signifies compliance with some other legislation (e.g., China and Korea RoHS). Please refer to the Knowles Precision Devices Sales Office for details of compliance with other

materials legislation. Breakdown of material content, SGS analysis reports and tin whisker test results are available on request. Most Knowles MLCC components are available with non-RoHS compliant tin lead (SnPb) solderable termination finish for exempt applications and where pure tin is not acceptable. Other tin-free termination finishes may also be available – please refer to the Knowles Precision Devices Sales Office for further details. Radial components have tin plated leads as standard, but tin/lead is available as a special option. Please refer to the radial section of the catalog for further details.

X8R ranges <250Vdc are not RoHS 2011/65/EU compliant. Check the website, knowlesc capacitors.com for latest RoHS update.

EXPORT CONTROLS AND DUAL-USE REGULATIONS

Certain Knowles catalog components are defined as "dual-use" items under international export controls — those that can be used for civil or military purposes which meet certain specified technical standards. The defining criteria for a dual-use component with respect to Knowles Capacitor products is one with a voltage rating of >750Vdc and a capacitance value of >250nF when measured at 750Vdc and a series inductance <10nH. Components defined as dual-use under the above criteria may require a licence for export across international borders. Please contact the Sales Office for further information on specific part numbers.



Explanation of Aging of MLC

AGING

Capacitor aging is a term used to describe the negative, logarithmic capacitance change that takes place in ceramic capacitors with time. The crystalline structure for barium titanate based ceramics changes on passing through its Curie temperature (known as the Curie Point) at about 125°C. This domain structure relaxes with time and in doing so, the dielectric constant reduces logarithmically; this is known as the aging mechanism of the dielectric constant. The more stable dielectrics have the lowest aging rates.

The aging process is reversible and repeatable. Whenever the capacitor is heated to a temperature above the Curie Point, the aging process starts again from zero.

The aging constant, or aging rate, is defined as the percentage loss of capacitance due to the aging process of the dielectric that occurs during a decade of time (a tenfold increase in age) and is expressed as percent per logarithmic decade of hours. As the law of decrease of capacitance is logarithmic, this means that in a capacitor with an aging rate of 1% per decade of time, the capacitance will decrease at a rate of:

- a) 1% between 1 and 10 hours
- b) An additional 1% between the following 10 and 100 hours
- c) An additional 1% between the following 100 and 1,000 hours
- d) An additional 1% between the following 1,000 and 10,000 hours, etc.
- e) The aging rate continues in this manner throughout the capacitor's life

Typical values of the aging constant for our Multilayer Ceramic Capacitors are:

Dielectric class	Typical values
Ultra Stable COG/NPO	Negligible capacitance loss through aging
Stable X7R	<2% per decade of time

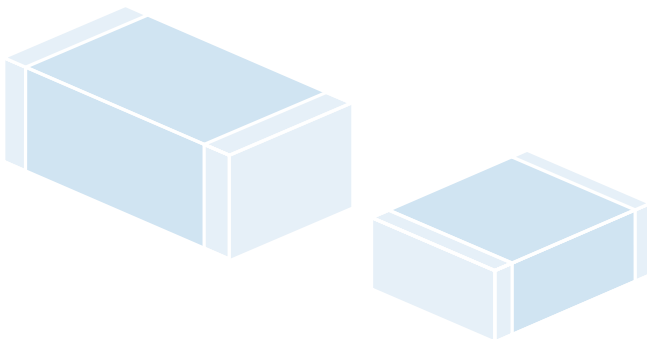

CAPACITANCE MEASUREMENTS

Because of aging it is necessary to specify an age for reference measurements at which the capacitance shall be within the prescribed tolerance. This is fixed at 1,000 hours, since for practical purposes there is not much further loss of capacitance after this time.

All capacitors shipped are within their specified tolerance at the standard reference age of 1,000 hours after having cooled through their Curie temperature.

The aging curve for any ceramic dielectric is a straight line when plotted on semi-log paper.

CAPACITANCE VS. TIME

(Aging X7R @ <2% per decade)

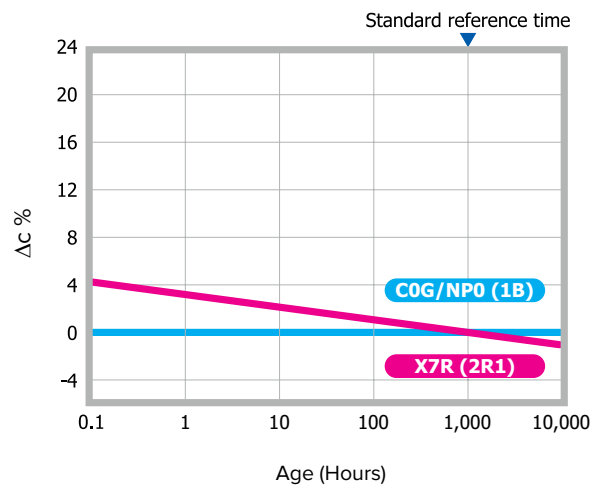

TIGHT TOLERANCE

One of the advantages of Knowles' unique "wet process" of manufacture is the ability to offer capacitors with exceptionally tight capacitance tolerances.

The accuracy of the printing screens used in the fully automated, computer controlled manufacturing process allows for tolerance as close as +/-1% on COG/NPO parts greater than or equal to 10pF. For capacitance values below <4.7pF, tolerances can be as tight as +/-0.05pF.



Mounting, Soldering, Storage and Mechanical Precautions

Detailed application notes intended to guide and assist our customers in using multilayer ceramic capacitors in surface mount technology are available on the Knowles website at knowlesc capacitors.com. The information concentrates on the handling, mounting, connection, cleaning, test and rework requirements particular to MLCs for SMD technology, to ensure a suitable match between component capability and user expectation. Some extracts are given below.

MECHANICAL CONSIDERATIONS FOR MOUNTED CERAMIC CHIP CAPACITORS

Due to their brittle nature, ceramic chip capacitors are more prone to excesses of mechanical stress than other components used in surface mounting. One of the most common causes of failure is directly attributable to bending the printed circuit board after solder attachment. The excessive or sudden movement of the flexible circuit board stresses the inflexible ceramic block, causing a crack to appear at the weakest point, usually the ceramic/termination interface. The crack may initially be quite small and not penetrate into the inner electrodes; however, subsequent handling and rapid changes in temperature may cause the crack to enlarge.

This mode of failure is often invisible to normal inspection techniques as the resultant cracks usually lie under the capacitor terminations, but if left, can lead to catastrophic failure. More importantly, mechanical cracks, unless they are severe, may not be detected by normal electrical testing of the completed circuit, failure only occurring at some later stage after moisture ingression.

The degree of mechanical stress generated on the printed circuit board is dependent upon several factors, including the board material and thickness, the amount of solder and land pattern. The amount of solder applied is important, as an excessive amount reduces the chip's resistance to cracking.

It is Knowles' experience that more than 90% are due to board depanelization, a process where two or more circuit boards are separated after soldering is complete. Other manufacturing stages that should be reviewed include:

- 1) Attaching rigid components such as connectors, relays, display panels, heat sinks etc.,
- 2) Fitting conventional leaded components. Special care must be exercised when rigid terminals, as found on large can electrolytic capacitors, are inserted.
- 3) Storage of boards in such a manner that allows warping.
- 4) Automatic test equipment, particularly the type employing "bed of nails" and support pillars.
- 5) Positioning the circuit board in its enclosure, especially where this is a "snap-fit"

Knowles was the first MLCC manufacturer to launch a flexible termination to significantly reduce the instances of mechanical cracking. FlexiCap™ termination introduces a certain amount of give into the termination layer, absorbing damaging stress. Unlike similar systems, FlexiCap™ does not tear under tension, but absorbs the stress, so maintaining the characteristics of the MLCC.

SM PAD DESIGN

Knowles conventional 2-terminal chip capacitors can generally be mounted using pad designs in accordance with IPC-7351, Generic Requirements for Surface Mount Design and Land Pattern Standards, but there are some other factors that have been shown to reduce mechanical stress, such as reducing the pad width to less than the chip width. In addition, the position of the chip on the board should also be considered.

3-Terminal components are not specifically covered by IPC-7351, but recommended pad dimensions are included in the Knowles catalogue / website for these components.

ALTERNATIVE PRINTED WIRE BOARD LAND PATTERNS

Printed Wire Board land pattern design for chip components is critical to ensure a reliable solder fillet, and to reduce nuisance type manufacturing problems such as component swimming and tombstoning. The land pattern suggested can be used for reflow and wave solder operations as noted. Land patterns constructed with these dimensions will yield optimized solder fillet formation and thus reduce the possibility of early failure.¹

¹ Frances Classon, James Root, Martin Marietta Orlando Aerospace, "Electronics Packaging and Interconnection Handbook".

$$A = (\text{Max Length}) + 0.030" (.762\text{mm})^*$$
$$B = (\text{Max Width}) + 0.010" (.254\text{mm})^{**}$$
$$C = (\text{Min Length}) - 2 (\text{Nominal Band})^{***}$$

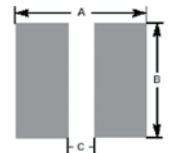

- * Add 0.030" for Wave Solder operations.
- ** Replace "Max Width" with "Max Thickness" for vertical mounting.
- *** "C" to be no less than 0.02", change "A" to (Max Length) + 0.020".

For C04 "C" to be no less than 0.01".

MLC ORIENTATION — HORIZONTAL AND VERTICAL MOUNTING

The orientation of the MLC relative to the ground plane affects the device's impedance. When the internal electrodes are parallel to the ground plane (horizontal mounting), the impedance of the MLC resembles a folded transmission line driven from one end.

The graphs below show the modeled insertion loss and parallel resonances of Knowles product C17AH101K-7UN-X0T with horizontal mounting (modeling can be done in CapCad). When the internal electrodes are perpendicular to the ground plane (vertical mounting, bottom graph), the MLC impedance resembles a folded transmission line driven from the center, reducing resonance effects.

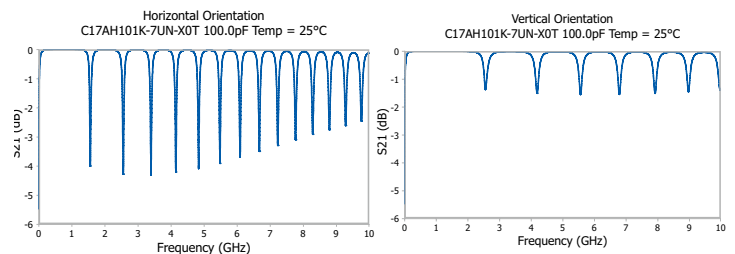

Mounting, Soldering, Storage and Mechanical Precautions

Knowles MLCCs are compatible with all recognized soldering/mounting methods for chip capacitors. Specific application notes on mounting and soldering Knowles components are included on the website for each brand.

- For DLI brand components, please see DLI application note “Recommended Solder Attachment Techniques for MLC Chip and Pre-Tinned Capacitors” located at: knowlescapacitors.com
- For Syfer brand components, please see Syfer application note AN0028 “Soldering/Mounting Chip Capacitors, Radial Leaded Capacitors and EMI Filters” located at: knowlescapacitors.com
- For Novacap brand products, please refer to the appropriate application note located at: knowlescapacitors.com

The volume of solder applied to the chip capacitor can influence the reliability of the device. Excessive solder can create thermal and tensile stresses on the component, which can lead to fracturing of the chip or the solder joint itself. Insufficient or uneven solder application can result in weak bonds, rotation of the device off line or lifting of one terminal off the pad (tombstoning). The volume of solder is process and board pad size dependent. Soldering methods commonly used in industry are Reflow Soldering, Wave Soldering and, to a lesser extent, Vapor Phase Soldering. All these methods involve thermal cycling of the components and therefore the rate of heating and cooling must be controlled to preclude thermal shocking of the devices.

Without mechanical restriction, thermally induced stresses are released once the capacitor attains a steady state condition. Capacitors bonded to substrates, however, will retain some stress, due primarily to the mismatch of expansion of the component to the substrate; the residual stress on the chip is also influenced by the ductility and hence the ability of the bonding medium to relieve the stress. Unfortunately, the thermal expansion of chip capacitors differs significantly from those of most substrate materials. Large chips are more prone to thermal shock as their greater bulk will result in sharper thermal gradients within the device during thermal cycling. Large units experience excessive stress if processed through the fast cycles typical of solder wave or vapor phase operations.

REFLOW SOLDERING SURFACE MOUNT CHIP CAPACITORS

Knowles recommends reflow soldering as the preferred method for mounting MLCCs. Knowles MLCCs can be reflow soldered using a reflow profile generally as defined in IPC/JEDEC J-STD-020. Sn plated termination chip capacitors are compatible with both conventional and lead-free soldering, with peak temperatures of 260°C to 270°C acceptable. The heating ramp rate should be such that components see a temperature rise of 1.5°C to 4°C per seconds to maintain temperature uniformity through the MLCC. The time for which the solder is molten should be maintained at a minimum, so as to prevent solder leaching. Extended times above 230°C can cause problems with oxidation of Sn plating. Use of inert atmosphere can help if this problem is encountered. PdAg terminations can be particularly susceptible to leaching with lead-free, tin-rich solders and trials are recommended for this combination. Cooling to ambient temperature should be allowed to occur naturally, particularly if larger chip sizes are being soldered. Natural cooling allows a gradual relaxation of thermal mismatch stresses in the solder joints. Forced cooling should be avoided as this can induce thermal breakage.

WAVE SOLDERING SURFACE MOUNT CHIP CAPACITORS

Wave soldering is generally acceptable, but the thermal stresses caused by the wave have been shown to lead to potential problems with larger or thicker chips. Particular care should be taken when soldering SM chips larger than size 1210 and with a thickness greater than 1.0mm for this reason. 0402 size components are not suitable for wave soldering. 0402 size components can also be susceptible to termination leaching, and reflow soldering is recommended for this size MLCC.

Wave soldering exposes the devices to a large solder volume, hence the pad size area must be restricted to accept an amount of solder that is not detrimental to the chip size utilized. Typically the pad width is 66% of the component width, and the length is .030" (.760mm) longer than the termination band on the chip. A 0805 chip, which is .050" wide and has a .020" termination band therefore requires a pad .033" wide by .050" in length. Opposing pads should be identical in size to preclude uneven solder fillets and mismatched surface tension forces, which can misalign the device. It is preferred that the pad layout results in alignment of the long axis of the chips at right angles to the solder wave, to promote even wetting of all terminals. Orientation of components in line with the board travel direction may require dual waves with solder turbulence to preclude cold solder joints on the trailing terminals of the devices, as these are blocked from full exposure to the solder by the body of the capacitor.

The preheat ramp should be such that the components see a temperature rise of 1.5°C to 4°C per second as for reflow soldering. This is to maintain temperature uniformity through the MLCC and prevent the formation of thermal gradients within the ceramic. The preheat temperature should be within 120°C maximum (100°C preferred) of the maximum solder temperature to minimize thermal shock. Maximum permissible wave temperature is 270°C for SM chips. Total immersion exposure time for Sn/Ni terminations is 30s at a wave temperature of 260°C. Note that for multiple soldering operations, including the rework, the soldering time is cumulative. The total immersion time in the solder should be kept to a minimum. It is strongly recommended that plated terminations are specified for wave soldering applications. PdAg termination is particularly susceptible to leaching when subjected to lead-free wave soldering and is not generally recommended for this application. Cooling to ambient temperature should be allowed to occur naturally, particularly if larger chip sizes are being soldered. Natural cooling allows a gradual relaxation of thermal mismatch stresses in the solder joints. Forced cooling should be avoided as this can induce thermal breakage.

VAPOR PHASE SOLDERING CHIP CAPACITORS

Vapor phase soldering can expose capacitors to similar thermal shock and stresses as wave soldering, and the advice is generally the same. Particular care should be taken in soldering large capacitors to avoid thermal cracks being induced and natural cooling should be used to allow a gradual relaxation of stresses.

HAND SOLDERING AND REWORK OF CHIP CAPACITORS

Attachment using a soldering iron requires extra care and is accepted to have a risk of cracking of the chip. Precautions include preheating of the assembly to within 100°C of the solder flow temperature and the use of a fine tip iron that does not exceed 30 watts. In no circumstances should the tip of the iron be allowed to contact the chip directly. Knowles recommends hot air/gas as the preferred method for applying heat for rework. Apply even heat surrounding the component to minimize internal thermal gradients. Minimize the rework heat duration and allow components to cool naturally after soldering.



Mounting, Soldering, Storage and Mechanical Precautions

WAVE SOLDERING RADIAL LEADED CHIP CAPACITORS

Radial leaded capacitors are suitable for wave soldering when mounted on the opposite side of the board to the wave. The body of radial components should not be exposed directly to the wave. Maximum permissible wave temperature is 260°C for Radial leaded capacitors.

HAND SOLDERING RADIAL LEADED CAPACITORS

Radial capacitors can be hand soldered into boards using soldering irons, provided care is taken not to touch the body of the capacitor with the iron tip. Soldering should be carried out from the opposite side of the board to the radial to minimize the risk of damage to the capacitor body. Where possible, a heat sink should be used between the solder joint and the body, especially if longer dwell times are required.

SOLDER LEACHING

Leaching is the term for the dissolution of silver into the solder, causing a failure of the termination system, which causes increased ESR, $\tan \delta$ and open circuit faults, including, ultimately, the possibility of the chip becoming detached. Leaching occurs more readily with higher temperature solders and solders with a high tin content. Pb-free solders can be very prone to leaching certain termination systems. To prevent leaching, exercise care when choosing solder alloys and minimize both maximum temperature and dwell time with the solder molten.

Plated terminations with nickel or copper anti-leaching barrier layers are available in a range of top coat finishes to prevent leaching from occurring. These finishes also include Syfer FlexiCap™ for improved stress resistance post soldering.

BONDING

Hybrid assembly using conductive epoxy or wire bonding requires the use of silver palladium or gold terminations. Nickel barrier termination is not practical in these applications, as intermetallics will form between the dissimilar metals. The ESR will increase over time and may eventually break contact when exposed to temperature cycling.

CLEANING

Chip capacitors can withstand common agents such as water, alcohol and degreaser solvents used for cleaning boards. Ascertain that no flux residues are left on the chip surfaces as these diminish electrical performance.

HANDLING

Ceramics are dense, hard, brittle and abrasive materials. They are liable to suffer mechanical damage, in the form of chips or cracks, if improperly handled.

Terminations may be abraded onto chip surfaces if loose chips are tumbled in bulk. Metallic tracks may be left on the chip surfaces, which might pose a reliability hazard.

Components should never be handled with fingers; perspiration and skin oils can inhibit solderability and will aggravate cleaning. Chip capacitors should never be handled with metallic instruments. Metal tweezers should never be used as these can chip the product and may leave abraded metal tracks on the product surface. Plastic or plastic coated metal types are readily available and recommended — these should be used with an absolute minimum of applied pressure.

Counting or visual inspection of chip capacitors is best performed on a clean glass or hard plastic surface. If chips are dropped or subjected to rough handling, they should be visually inspected before use. Electrical inspection may also reveal gross damage via a change in capacitance, an increase in dissipation factor or a decrease either in insulation resistance or electrical strength.

TRANSPORTATION

Where possible, any transportation should be carried out with the product in its unopened original packaging. If already opened, any environmental control agents supplied should be returned to packaging and the packaging resealed.

Avoid paper and card as a primary means of handling, packing, transportation and storage of loose components. Many grades have a sulphur content that will adversely affect termination solderability. Loose chips should always be packed with sulphur-free wadding to prevent impact or abrasion damage during transportation.

STORAGE

Incorrect storage of components can lead to problems for the user. Rapid tarnishing of the terminations, with an associated degradation of solderability, will occur if the product comes into contact with industrial gases such as sulphur dioxide and chlorine. Storage in free air, particularly moist or polluted air, can result in termination oxidation.

Packaging should not be opened until the MLCs are required for use. If opened, the pack should be resealed as soon as is practicable. Alternatively, the contents could be kept in a sealed container with an environmental control agent. Long-term storage conditions, ideally, should be temperature controlled between -5°C and +40°C and humidity controlled between 40% and 60% RH. Taped product should be stored out of direct sunlight, which might promote deterioration in tape or adhesive performance.

Product, stored under the conditions recommended above, in its “as received” packaging has a minimum shelf life of 2 years.



Chip Marking System

Most, but not all, MLCCs can be supplied marked to indicate the capacitance value on request. Parts smaller than 1812 will generally use laser marking, chips sizes larger will use laser or ink marking at the Knowles' discretion. Neither system causes surface degradation and the ink is chosen to withstand most conventional MLCC cleaning processes. Some values of size/voltage may not be suitable for marking due to internal design parameters.



Two position alpha-numeric marking is available on chip sizes 0603 and larger. The marking denotes retma value and significant figures of capacitance (see table)
e.g., A5 = 100,000pF.

Three position alpha-numeric marking is available on chip sizes 1206 and larger.

Capacitance is shown using one of the following methods, depending on the size of the component:

- 2 digit EIA-198 code (see table below, e.g., N1 = 33pF). Where space allows, the brand identifier may also be applied (e.g., N = Novacap brand).
- 3-digit capacitance code as part number (e.g., 0330 = 33pF)
- Brand identifier, 3-digit capacitance code and tolerance (e.g., S/0330J = Syfer Brand, 33pF ± 5%)

MARKING CODE – VALUE IN PICO FARADS FOR ALPHA-NUMERIC CODE

Number	0	1	2	3	4	5	6	7	9	
Letter	A	1.0	10	100	1,000	10,000	100,000	1,000,000	10,000,000	0.10
	B	1.1	11	110	1,100	11,000	110,000	1,100,000	11,000,000	0.11
	C	1.2	12	120	1,200	12,000	120,000	1,200,000	12,000,000	0.12
	D	1.3	13	130	1,300	13,000	130,000	1,300,000	13,000,000	0.13
	E	1.5	15	150	1,500	15,000	150,000	1,500,000	15,000,000	0.15
	F	1.6	16	160	1,600	16,000	160,000	1,600,000	16,000,000	0.16
	G	1.8	18	180	1,800	18,000	180,000	1,800,000	18,000,000	0.18
	H	2.0	20	200	2,000	20,000	200,000	2,000,000	20,000,000	0.20
	J	2.2	22	220	2,200	22,000	220,000	2,200,000	22,000,000	0.22
	K	2.4	24	240	2,400	24,000	240,000	2,400,000	24,000,000	0.24
	L	2.7	27	270	2,700	27,000	270,000	2,700,000	27,000,000	0.27
	M	3.0	30	300	3,000	30,000	300,000	3,000,000	30,000,000	0.30
	N	3.3	33	330	3,300	33,000	330,000	3,300,000	33,000,000	0.33
	P	3.6	36	360	3,600	36,000	360,000	3,600,000	36,000,000	0.36
	Q	3.9	39	390	3,900	39,000	390,000	3,900,000	39,000,000	0.39
	R	4.3	43	430	4,300	43,000	430,000	4,300,000	43,000,000	0.43
	S	4.7	47	470	4,700	47,000	470,000	4,700,000	47,000,000	0.47
	T	5.1	51	510	5,100	51,000	510,000	5,100,000	51,000,000	0.51
	U	5.6	56	560	5,600	56,000	560,000	5,600,000	56,000,000	0.56
	V	6.2	62	620	6,200	62,000	620,000	6,200,000	62,000,000	0.62
	W	6.8	68	680	6,800	68,000	680,000	6,800,000	68,000,000	0.68
	X	7.5	75	750	7,500	75,000	750,000	7,500,000	75,000,000	0.75
	Y	8.2	82	820	8,200	82,000	820,000	8,200,000	82,000,000	0.82
	Z	9.1	91	910	9,100	91,000	920,000	9,200,000	92,000,000	0.91
	a	2.5	25	250	2,500	25,000	250,000	2,500,000	25,000,000	0.25
	b	3.5	35	350	3,500	35,000	350,000	3,500,000	35,000,000	0.35
d	4.0	40	400	4,000	40,000	400,000	4,000,000	40,000,000	0.40	
e	4.5	45	450	4,500	45,000	450,000	4,500,000	45,000,000	0.45	
f	5.0	50	500	5,000	50,000	500,000	5,000,000	50,000,000	0.50	
m	6.0	60	600	6,000	60,000	600,000	6,000,000	60,000,000	0.60	
n	7.0	70	700	7,000	70,000	700,000	7,000,000	70,000,000	0.70	
t	8.0	80	800	8,000	80,000	800,000	8,000,000	80,000,000	0.80	
y	9.0	90	900	9,000	90,000	900,000	9,000,000	90,000,000	0.90	



Ceramic Chip Capacitors — Packaging Information

Tape and reel packing of surface mounting chip capacitors for automatic placement are in accordance with IEC60286-3.

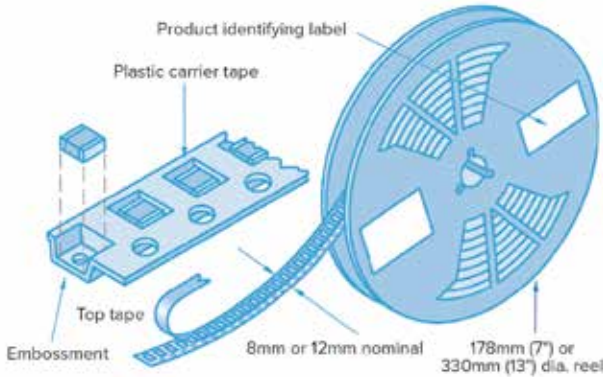

Dimensions
mm (inches)

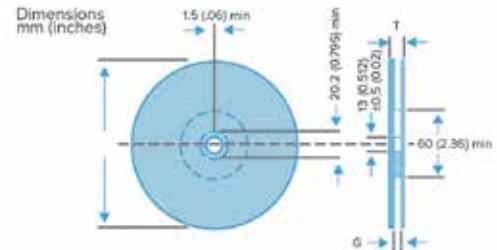

PEEL FORCE

The peel force of the top sealing tape is between 0.2 and 1.0 Newton at 180°. The breaking force of the carrier and sealing tape in the direction of unreeling is greater than 10 Newtons.

IDENTIFICATION

Each reel is labeled with the following information: manufacturer, chip size, capacitance, tolerance, rated voltage, dielectric type, batch number, date code and quantity of components.

MISSING COMPONENTS

Maximum number of missing components shall be 1 per reel or 0.025%, whichever is greater. There shall not be consecutive components missing from any reel for any reason.

TAPE DIMENSIONS

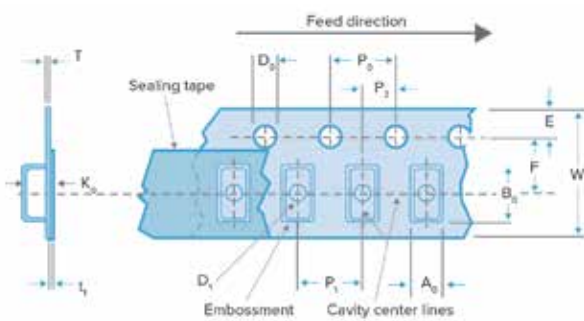

Symbol	Description	178mm reel	330mm reel
A	Diameter	178 (7)	330 (13)
G	Inside width	8.4 (0.33)	12.4 (0.49)
T	Outside width	14.4 (0.56) max	18.4 (0.72) max

LEADER AND TRAILER

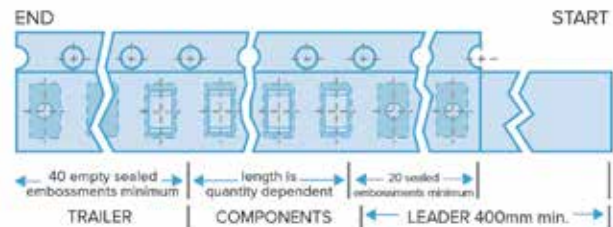

		Dimensions mm (inches)	
Symbol	Description	8mm tape	12mm tape
A ₀	Width of cavity	Dependent on chip size to minimize rotation	
B ₀	Length of cavity		
K ₀	Depth of cavity		
W	Width of tape	8.0 (0.315)	12.0 (0.472)
F	Distance between drive hole centers and cavity centers	3.5 (0.138)	5.5 (0.213)
E	Distance between drive hole centers and tape edge	1.75 (0.069)	
P ₁	Distance between cavity centers	4.0 (0.156)	8.0 (0.315)
P ₂	Axial distance between drive hole centers and cavity centers	2.0 (0.079)	
P ₀	Axial distance between drive hole centers	4.0 (0.156)	
D ₀	Drive hole diameter	1.5 (0.059)	
D ₁	Diameter of cavity piercing	1.0 (0.039)	1.5 (0.059)
T	Carrier tape thickness	0.3 (0.012) ±0.1 (0.004)	0.4 (0.016) ±0.1 (0.004)
t ₁	Top tape thickness	0.1 (0.004) max	



Ceramic Chip Capacitors — Packaging Information

COMPONENT ORIENTATION

Tape and reeling is in accordance with IEC 60286 part 3, which defines the packaging specifications of leadless components on continuous tapes.

Notes:

- 1) IEC60286-3 states $A_o \leq B_o$ (see tape dimensions on page 21).
- 2) Regarding the orientation of 1825 and 2225 components, the termination bands are right to left, NOT front to back. Please see diagram.

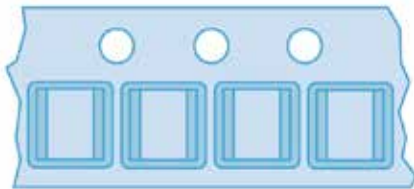

Orientation of 1825 & 2225 components

OUTER PACKAGING

OUTER CARTON DIMENSIONS MM (INCHES) MAX.

Reel Size	No. of reels	L	W	T
178 (7.0)	1	185 (7.28)	185 (7.28)	25 (0.98)
178 (7.0)	4	190 (7.48)	195 (7.76)	75 (2.95)
330 (13.0)	1	335 (13.19)	335 (13.19)	25 (0.98)

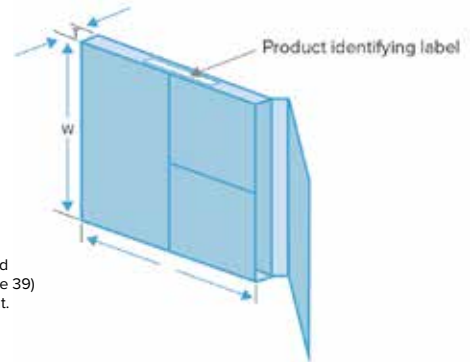

Note: Labeling of box and reel with bar codes (Code 39) available by arrangement.

STANDARD REEL QUANTITIES — NOVACAP, SYFER AND VOLTRONICS PRODUCTS

Chip size	0402	0505	0603	0805	1111	1206	1210	1410	1515	1808	1812	1825	2211	2215	2220	2221	2225	2520	3333	3530	3640	4540	5550	6560	7565	
Max. chip thickness																										
mm	0.61	1.3	0.89	1.37	1.8	1.63	2.0	2.0	3.3	2.0	3.2	4.2	2.5	2.5	4.2	2.0	4.2	4.57	6.35	6.35	4.2	7.62	7.62	7.62	7.62	
inches	0.02"	0.05"	0.03"	0.05"	0.07"	0.06"	0.08"	0.08"	0.13"	0.08"	0.13"	0.165"	0.1"	0.1"	0.165"	0.08"	0.165"	0.18"	0.25"	0.25"	0.165"	0.3"	0.3"	0.3"	0.3"	
Reel quantities																										
178mm (7")	10k	2500	4000	3000	1000	2500	2000	2000	500	1500	500	500	750	500	500	1000	500	-	-	-	-	-	-	-	-	-
330mm (13")	15k	10k	16k	12k	5000	10k	8000	8000	-	6000	2000	2000	2000	2000	2000	-	2000	1000	1000	500	500	500	500	500	200	200

Note: Chip thickness may affect reel quantity.

PACKAGING CONFIGURATIONS — DLI PRODUCTS

Style	Chip Size L x W	7" Reel, 8mm Tape		7" Reel, 16mm Tape	13" Reel, 16mm Tape	2" x 2" Waffle Pack
		Horizontal Orientation	Vertical Orientation			
C04	0.040" x 0.020"	4000	-	-	-	-
C06	0.060" x 0.030"	4000	-	-	-	108
C07	0.110" x 0.070"	2000	-	-	-	-
C08	0.080" x 0.050"	5000	3100	-	-	108
C11	0.055" x 0.055"	3500	3100	-	-	108
C17	0.110" x 0.110"	2350	750	-	-	49
C18	0.110" x 0.110"	2350	750	-	-	49
C22	0.220" x 0.245"	500	-	-	-	-
C40	0.380" x 0.380"	250	-	250	1300	-

BULK PACKAGING, TUBS

Chips can be supplied in rigid resealable plastic tubs together with impact cushioning wadding. Tubs are labeled with the details: chip size, capacitance, tolerance, rated voltage, dielectric type, batch number, date code and quantity of components.

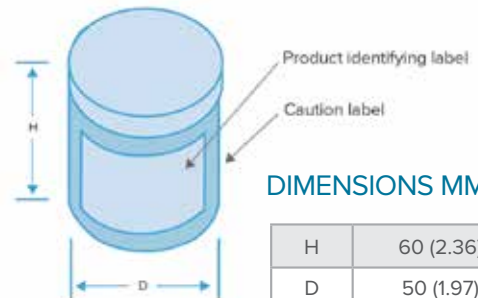

DIMENSIONS MM (INCHES)

H	60 (2.36)
D	50 (1.97)



Chip Dimensions

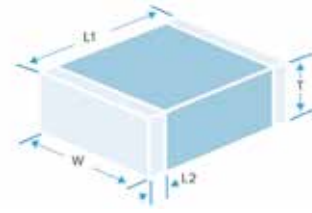

1. For FlexiCap™ terminations, length increases by maximum 0.004" (0.1mm).
2. Dimensions for High Q, Ultra-low ESR and Non-magnetic parts may vary for optimum performance.
For accurate part dimensions, use the Part Builder or Part Search application on the Knowles website to generate a component datasheet.
3. Non-standard thicknesses are available – consult your local Knowles Precision Devices sales office.

Size	Length (L1)	Width (W)	Max. Thickness (T)	Termination Band (L2)	
	mm ~ inches	mm ~ inches	mm ~ inches	min (mm ~ inches)	max (mm ~ inches)
0402	1.0 ± 0.10 ~ 0.04 ± 0.004	0.50 ± 0.10 ~ 0.02 ± 0.004	0.60 ~ 0.024	0.10 ~ 0.004	0.40 ~ 0.016
C04	1.057 ± 0.188 ~ 0.042 ± 0.008	0.515 ± 0.153 ~ 0.02 ± 0.006	0.64 ~ 0.025	0.097 ~ 0.004	0.427 ~ 0.017
0504	1.27 ± 0.152 ~ 0.050 ± 0.006	1.02 ± 0.152 ~ 0.04 ± 0.006	1.12 ~ 0.044	0.20 ~ 0.008	0.50 ~ 0.02
0505	1.4 +0.35/-0.25 ~ 0.055 +0.014/-0.01	1.4 ± 0.25 ~ 0.055 ± 0.01	1.27 ~ 0.05	0.13 ~ 0.005	0.5 ~ 0.02
RF0505	1.4 +0.38/-0.25 ~ 0.055 +0.015/-0.01	1.4 ± 0.381 ~ 0.055 ± 0.015	1.45 ~ 0.057	0.20 ~ 0.008	0.50 ~ 0.02
C11	1.477 ± 0.391 ~ 0.059 ± 0.016	1.416 ± 0.451 ~ 0.056 ± 0.018	1.334 ~ 0.053	0.193 ~ 0.008	0.733 ~ 0.029
0603	1.6 ± 0.15 ~ 0.063 ± 0.006	0.8 ± 0.15 ~ 0.032 ± 0.006	0.90 ~ 0.036	0.20 ~ 0.004	0.40 ~ 0.016
C06	1.532 ± 0.229 ~ 0.06 ± 0.009	0.77 ± 0.191 ~ 0.031 ± 0.008	0.8 ~ 0.032	0.169 ~ 0.007	0.680 ~ 0.027
C07	1.797 ± 0.470 ~ 0.071 ± 0.019	2.813 ± 0.521 ~ 0.111 ± 0.021	2.667 ~ 0.105	0.193 ~ 0.008	1.20 ~ 0.047
0805	2.0 ± 0.20 ~ 0.079 ± 0.008	1.25 ± 0.20 ~ 0.049 ± 0.008	1.37 ~ 0.054	0.25 ~ 0.010	0.75 ~ 0.030
C08	2.048 ± 0.407 ~ 0.081 ± 0.016	1.28 ± 0.267 ~ 0.051 ± 0.011	1.360 ~ 0.054	0.362 ~ 0.014	1.04 ~ 0.041
0907	2.3 ± 0.30 ~ 0.090 ± 0.012	1.8 ± 0.30 ~ 0.070 ± 0.012	1.52 ~ 0.06	0.25 ~ 0.010	0.75 ~ 0.030
1005	2.54 ± 0.203 ~ 0.100 ± 0.008	1.27 ± 0.203 ~ 0.050 ± 0.008	1.37 ~ 0.054	0.25 ~ 0.010	0.75 ~ 0.030
1111	2.79 +0.51/-0.25 ~ 0.11 +0.02/-0.01	2.79 ± 0.38 ~ 0.113 ± 0.015	1.78 ~ 0.07	0.13 ~ 0.005	0.63 ~ 0.025
RF1111	2.79 +0.64/-0.25 ~ 0.11 +0.025/-0.01	2.79 ± 0.381 ~ 0.110 ± 0.015	2.59 ~ 0.102	0.25 ~ 0.010	0.75 ~ 0.030
C17	2.94 ± 0.527 ~ 0.116 ± 0.021	2.813 ± 0.521 ~ 0.111 ± 0.021	2.667 ~ 0.105	0.193 ~ 0.008	1.2 ~ 0.047
C18	3.14 ± 0.727 ~ 0.124 ± 0.029	2.946 ± 0.654 ~ 0.116 ± 0.026	2.667 ~ 0.105	0.193 ~ 0.008	1.2 ~ 0.047
1206	3.2 ± 0.20 ~ 0.126 ± 0.008	1.6 ± 0.20 ~ 0.063 ± 0.008	1.70 ~ 0.068	0.25 ~ 0.010	0.75 ~ 0.030
1210	3.2 ± 0.20 ~ 0.126 ± 0.008	2.5 ± 0.20 ~ 0.098 ± 0.008	2.0 ~ 0.08	0.25 ~ 0.010	0.75 ~ 0.030
1515	3.81 ± 0.381 ~ 0.150 ± 0.015	3.81 ± 0.381 ~ 0.150 ± 0.015	3.3 ~ 0.13	0.381 ~ 0.015	1.143 ~ 0.045
1808	4.5 ± 0.35 ~ 0.180 ± 0.014	2.0 ± 0.30 ~ 0.08 ± 0.012	2.0 ~ 0.08	0.25 ~ 0.01	1.0 ~ 0.04
1812	4.5 ± 0.30 ~ 0.180 ± 0.012	3.2 ± 0.20 ~ 0.126 ± 0.008	3.2 ~ 0.125	0.25 ~ 0.010	1.143 ~ 0.045
1825	4.5 ± 0.30 ~ 0.180 ± 0.012	6.40 ± 0.40 ~ 0.252 ± 0.016	4.2 ~ 0.16	0.25 ~ 0.010	1.0 ~ 0.04
2020	5.0 ± 0.40 ~ 0.197 ± 0.016	5.0 ± 0.40 ~ 0.197 ± 0.016	4.5 ~ 0.18	0.25 ~ 0.01	1.0 ~ 0.04
2220	5.7 ± 0.40 ~ 0.225 ± 0.016	5.0 ± 0.40 ~ 0.197 ± 0.016	4.2 ~ 0.165	0.25 ~ 0.01	1.0 ~ 0.04
2211	5.7 ± 0.40 ~ 0.225 ± 0.016	2.79 ± 0.30 ~ 0.11 ± 0.012	2.5 ~ 0.1	0.25 ~ 0.01	0.8 ~ 0.03
2215	5.7 ± 0.40 ~ 0.225 ± 0.016	3.81 ± 0.35 ~ 0.35 ± 0.02	2.5 ~ 0.1	0.25 ~ 0.01	0.8 ~ 0.03
2221	5.59 ± 0.381 ~ 0.220 ± 0.015	5.33 ± 0.381 ~ 0.210 ± 0.015	2.03 ~ 0.08	0.381 ~ 0.015	1.143 ~ 0.045
2225	5.7 ± 0.40 ~ 0.225 ± 0.016	6.30 ± 0.40 ~ 0.252 ± 0.016	4.2 ~ 0.165	0.381 ~ 0.01	1.143 ~ 0.045
C22	5.734 ± 0.667 ~ 0.226 ± 0.026	6.37 ± 0.699 ~ 0.251 ± 0.028	3.467 ~ 0.137	N/A	N/A
2520	6.35 ± 0.40 ~ 0.250 ± 0.016	5.08 ± 0.40 ~ 0.200 ± 0.016	4.57 ~ 0.18	0.381 ~ 0.015	1.143 ~ 0.045
RF2525	5.84 ± 0.51 ~ 0.230 ± 0.020	6.35 ± 0.381 ~ 0.250 ± 0.015	4.19 ~ 0.165	0.381 ~ 0.015	1.143 ~ 0.045
3333	8.38 ± 0.432 ~ 0.330 ± 0.017	8.38 ± 0.432 ~ 0.330 ± 0.017	6.35 ~ 0.25	0.381 ~ 0.015	1.143 ~ 0.045
3530	8.89 ± 0.457 ~ 0.350 ± 0.018	7.62 ± 0.381 ~ 0.300 ± 0.015	6.35 ~ 0.25	0.381 ~ 0.015	1.143 ~ 0.045
3640	9.2 ± 0.50 ~ 0.36 ± 0.02	10.16 ± 0.50 ~ 0.40 ± 0.02	4.5 ~ 0.18	0.50 ~ 0.02	1.50 ~ 0.06
C40	9.732 ± 0.804 ~ 0.384 ± 0.032	8.665 ± 1.737 ~ 0.381 ± 0.029	3.467 ~ 0.137	N/A	N/A
4040	10.2 ± 0.508 ~ 0.400 ± 0.020	10.2 ± 0.508 ~ 0.400 ± 0.020	7.62 ~ 0.30	0.50 ~ 0.02	1.50 ~ 0.06
4540	11.4 ± 0.584 ~ 0.450 ± 0.023	10.2 ± 0.508 ~ 0.400 ± 0.020	7.62 ~ 0.30	0.50 ~ 0.02	1.50 ~ 0.06
5440	13.7 ± 0.686 ~ 0.540 ± 0.027	10.2 ± 0.508 ~ 0.400 ± 0.020	7.62 ~ 0.30	0.50 ~ 0.02	1.50 ~ 0.06
5550	14.0 ± 0.711 ~ 0.550 ± 0.028	12.7 ± 0.635 ~ 0.500 ± 0.025	7.62 ~ 0.30	0.50 ~ 0.02	1.50 ~ 0.06
6560	16.5 ± 0.838 ~ 0.650 ± 0.033	15.2 ± 0.762 ~ 0.600 ± 0.030	7.62 ~ 0.30	0.50 ~ 0.02	1.50 ~ 0.06
7565	19.1 ± 0.965 ~ 0.750 ± 0.038	16.5 ± 0.838 ~ 0.650 ± 0.033	7.62 ~ 0.30	0.50 ~ 0.02	1.50 ~ 0.06
8060	20.3 ± 0.5 ~ 0.80 ± 0.02	15.24 ± 0.50 ~ 0.60 ± 0.02	4.2 ~ 0.165	0.50 ~ 0.02	1.50 ~ 0.06



Chip Ordering Information — DLI Brand Parts

C	17	CF	620	J	-	7	U	N	-	X	0	T
MLC Capacitor	Case Size	Dielectric	Capacitance Codes	Capacitance Tolerance		Rated Voltage	Termination	Lead Type		Test Level	Marking	Packaging

CASE SIZE

Case	Dimensions
04	0.040" x 0.020"
06	0.060" x 0.030"
07	0.110" x 0.070"
08	0.080" x 0.050"
11	0.055" x 0.055"
17	0.110" x 0.110"
18	0.110" x 0.110"
22	0.220" x 0.250"
40	0.380" x 0.380"

DIELECTRIC CODES

Material	Characteristics
AH	P90 High-Q Porcelain
CF	NP0 High-Q Porcelain
UL	NP0 Ultra Low ESR

CAPACITANCE CODES

1st two digits are significant figures of capacitance, 3rd digit denotes number of zeros, R = decimal point
Examples:

1R0	1.0pF
120	12pF
471	470pF
102	1,000pF

TERMINATION CODES

CODE	Termination System
T	Ag Termination, Ni Barrier Layer, Heavy SnPb Plated Solder
U	Ag Termination, Ni Barrier Layer, SnPb Plated Solder
S	Ag Termination, Ni Barrier Layer, Gold Flash**
Z	Ag Termination, Ni Barrier Layer, Sn Plated Solder**
E	Ag Terier, Sn Plated Solder**
P*	AgPd Termination**
Q	Polymer Termination, Ni Barrier Layer, Sn Plated Solder**
Y	Polymer Termination, Ni Barrier Layer, SnPb Plated Solder
M*	Polymer Termination, Cu Barrier Layer, Sn Plated Solder**
W*	Ag Termination, Cu Barrier Layer, Sn Plated Solder**
H*	Ag Termination, Enhanced Cu Barrier, Sn Plated Solder**
V*	Ag Termination, Cu Barrier Layer, SnPb Plated Solder
R*	Ag Termination, Cu Barrier Layer, Heavy SnPb Plated Solder

* Nonmagnetic **Indicates RoHS terminations

CAPACITANCE TOLERANCE

Code	Value
A	± 0.05pF
B	± 0.1pF
C	± 0.25pF
D	± 0.5pF
F	± 1%
G	± 2%
J	± 5%
K	± 10%
M	± 20%
X	GMV
S	SPECIAL

<10pF A, B, C, D
>10pF F, G, J, K, M

VOLTAGE CODES

Code	Value
5	50V
1	100V
8	150V
6	200V
9	250V
3	300V
4	500V
7	1kV
A	1.5kV
G	2kV
B	2.5kV
D	3.6kV
H	7.2kV
S	SPECIAL

LEADING

Code	Lead Type
A	Axial Ribbon
B	Radial Ribbon
C	Center Ribbon
D	Specialty Customer Defined
E	Axial Wire
F	Radial Wire
N	NONE

Note: Consult your local Sales Office for RoHS-compliant leaded devices.

TEST LEVEL

Code	Testing
X	Commercial or Industrial
Y	Reduced Visual
A	MIL-PRF-55681 Group A
C	MIL-PRF-55681 Group C
D	Customer Specified

LASER MARK

Code	Laser Marking
0	No Marking
1*	Single-Side Marked
2*	Double-Side Marked
3*	Large Single-Side Marked
4*	Large Double-Side Marked
5*	Vertical Edge Marked
9	Customer Specified

*Reduces DWV Rating.

PACKAGING

Code	Packaging
T	Tape & Reel – Horizontal
V	Tape & Reel – Vertical
W	Waffle Pack
B	Bulk
P	Plastic Box
R	Tube (Rail)
S	Customer Specified

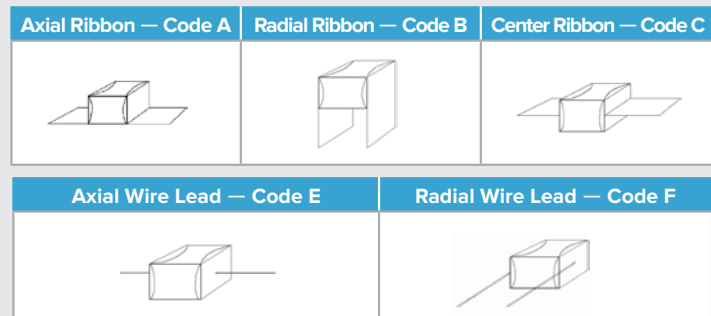

Chip Ordering Information — Novacap Brand Parts

XX	1206	N	472	J	101	N	X050	H	T	M	-	HB
Prefix	Case Size	Dielectric	Capacitance Codes	Capacitance Tolerance	Voltage	Termination	Special Thickness	High Reliability Testing	Packaging	Marking		High Reliability Test Criteria

PREFIX DEFINITIONS

None	Standard Chip	
RF	Improved ESR Capacitor	p. 37
ST	Stacked Capacitor Assembly	p. 83-88
SM	Stacked Hi-Rel Capacitor Assembly	p. 83-88
CR	Cap Rack Arrays	p. 89
SV	Stacked Vertical Capacitor Assembly	p. 90

DIELECTRIC CODES

N	COG/NP0	Ultra Stable
K	R3L	Ultra Stable
B	X7R	Stable
W	X5R	Stable
X	BX	MIL
BB	X7R	Stable BME
BW	X5R	Stable BME
M	COG/NP0	Non-Magnetic
C	X7R	Non-Magnetic
F	COG/NP0	High Temp. (up to 160°C)
D, RD	COG/NP0	High Temp. (up to 200°C)
S	X8R	High Temp. (up to 150°C)
E, RE	Class II	High Temp. (up to 200°C)
G	Class II	High Temp. (up to 160°C)
RN	COG/NP0	Lead Free
RB	X7R	Lead Free

CAPACITANCE CODES

1st two digits are significant figures of capacitance, 3rd digit denotes number of zeros, R = decimal point Examples:	1R0	1.0pF
	120	12pF
	471	470pF
	102	1,000pF
	273	0.027μF
	474	0.47μF
	105	1.0μF

CAPACITANCE TOLERANCE CODES

Code	Tolerance	COG/NP0			R3L	X7R		BX	X8R	Class II	X5R
	*Not RF series	N	M	F/D, RD	K	B	C, RE	X	S	E/G	W
B	±0.10pF	●	●								
C	±0.25pF	●	●		●						
D	±0.50pF	●	●		●						
F	±1%	●	●	●							
G	±2%	●	●	●	●						
J	±5%	●	●	●	●	●*	●	●*	●	●	
K	±10%	●	●	●	●	●	●	●	●	●	●
M	±20%	●		●	●	●	●	●	●	●	●

SPECIAL THICKNESS

None	Standard thickness as per Novacap catalog specifications
X	Denotes a special thickness other than standard. Specify in inches if required. (As shown above X = 0.050")

HIGH RELIABILITY TESTING

None	No voltage conditioning/burn-in
H	Voltage conditioning/burn-in*

*Option H is required for Testing Criteria HB, HV, HS, HK, and is optional for HH. For high temperature dielectrics, option H includes high temperature screening.

MARKING

None	Unmarked
M	Marked *Marking not available on sizes ≤ 0603

Note: Refer to page 20.

PACKAGING

None	Bulk
T	Tape and Reel
W	Waffle Pack

HIGH RELIABILITY TESTING CRITERIA

HB	MIL-PRF-55681 Group A
HV	MIL-PRF-49467 Group A
HS	MIL-PRF-123 Group A
HK	MIL-PRF-38534 Class K
HH	MIL-PRF-38534 Class H

VOLTAGE CODES

1st two digits are significant, third digit denotes number of zeros.
For example:

160	16 Volts
101	100 Volts
501	500 Volts
102	1,000 Volts
502	5,000 Volts
103	10,000 Volts

TERMINATION CODES

P	Palladium Silver	
PR	Palladium Silver*	
K	Solderable Palladium Silver*	
N	Nickel Barrier*	100% tin
Y	Nickel Barrier	90% tin, 10% lead
NG	Nickel Barrier Gold Flash*	
C	FlexiCap™/Nickel Barrier*	100% tin
D	FlexiCap™/Nickel Barrier	90% tin, 10% lead
B	Copper Barrier*	100% tin
E	Copper Barrier	90% tin, 10% lead
S	Silver*	

*Indicates RoHS terminations



Chip Ordering Information — Syfer Brand Parts

1210	Y	100	0103	K	X	T	---
Chip Size	Termination	Voltage	Capacitance in Picofarads (pF)	Capacitance Tolerance	Dielectric	Packaging	Suffix Code

CASE CODE

0402
0603
0805
1206
1210
1808
1812
1825
2220
2225
3640
4040
5550
8060

CAPACITANCE TOLERANCE CODES

Code	Tolerance	Cap. Value < 4.7pF
H	±0.05pF	Cap. Value < 10pF
H	±0.05pF	
B	±0.10pF	
C	±0.25pF	
D	±0.50pF	
F	±1%	Cap. Value ≥ 10pF
G	±2%	
J	±5%	
K	±10%	
M	±20%	

PACKAGING

Code	
T	178mm (7") reel
R	330mm (13") reel
B	Bulk pack — tubs or trays

SUFFIX DEFINITIONS

Used for specific customer requirements

PXX	Palladium electrodes
LS*	Chip marking *(consult Sales Office)

TERMINATION CODES

Code	Termination	Plating
A	Nickel barrier	90%/10% tin/lead
F	Palladium Silver*	
H	FlexiCap™/Nickel Barrier	90%/10% tin/lead
J	Nickel Barrier*	100% tin
Y	FlexiCap™/Nickel Barrier*	100% tin
2	Copper Barrier* (Non-Mag)	100% tin
3	FlexiCap™/Copper Barrier* (Non-Mag)	100% tin
4	Copper Barrier (Non-Mag)	90%/10% tin/lead
5	FlexiCap™/Copper Barrier (Non-Mag)	90%/10% tin/lead

*Indicates RoHS terminations

DIELECTRIC CODES

Code	Dielectric	Feature
C	COG/NP0 (1B)	Ultra Stable
H	X8G	Ultra Stable/High Q
P	X5R	Stable
X	X7R (2R1)	Stable
J	X7R (2R1)(BME)	Stable
N	X8R	Stable
Z	Hiteca	Improved Stability
Q	COG/NP0 (1B)	Ultra Stable/High Q
U	COG/NP0 (1B)	Ultra Stable/Ultra-Low ESR
A	COG/NP0 (1B)	AEC -Q200 Approved
S	X7R (2R1)(BME)	AEC -Q200 Approved
E	X7R (2R1)	AEC -Q200 Approved
T	X8R	AEC -Q200 Approved
K	COG/NP0 (1B)(BME)	AEC -Q200 Approved
Y	Hiteca	AEC -Q200 Approved
F	COG/NP0 (1B)	IECQ-CECC Release
D	X7R (2R1)	IECQ-CECC Release
R	BZ (2C1)	IECQ-CECC Release
B	BX (2X1)	IECQ-CECC Release
G	COG/NP0 (1B)(BME)	Ultra Stable

VOLTAGE CODES

Code	Value	Code	Value	Code	Value
010	10Vdc	1K0	1kVdc	A25	250Vac
016	16Vdc	1K2	1.2kVdc		
025	25Vdc	1K5	1.5kVdc		
050	50Vdc	2K0	2kVdc		
063	63Vdc	2K5	2.5kVdc		
100	100Vdc	3K0	3kVdc		
200	200Vdc	4K0	4kVdc		
250	250Vdc	5K0	5kVdc		
500	500Vdc	6K0	6kVdc		
630	630Vdc	8K0	8kVdc		
		10K	10kVdc		
		12K	12kVdc		

CAPACITANCE CODES

Calculation	Example	Capacitance value
<1.0pF Insert a P for the decimal point as the 1st character.	P300	0.3pF (values in 0.1pF steps)
≥1.0pF & <10pF Insert a P for the decimal point as the 2nd character.	8P20	8.2pF (values are E24 series)
≥10pF 1st digit is 0. 2nd and 3rd digits are significant figures of capacitance value. 4th digit is number of zeros.	0101	100pF (values are E24 series)



COG/NPO (1B) — AEC-Q200 and Standard Ranges

COG/NPO (1B) — AEC-Q200 AND STANDARD RANGES — CAPACITANCE VALUES

	COG/NPO (1B)	0402	0603	0805	1206	1210	1808		
	Maximum Thickness (T)	0.6mm	0.8mm	1.3mm	1.7mm	1.91mm	2.0mm	2.8mm	2.0mm
10V	Standard	-	0.5pF-3.9nF	1.0pF-15nF	1.0pF-47nF	12nF-12nF	3.9pF-100nF	27nF- 33nF	4.7pF-100nF
16V	AEC-Q200	-	0.5pF-1.0nF	1.0pF-4.7nF	1.0pF-15nF	12nF-12nF	3.9pF-27nF	27nF- 33nF	4.7pF-27nF
	Standard	-	0.5pF-2.7nF	1.0pF-12nF	1.0pF-33nF	12nF-12nF	3.9pF-68nF	27nF- 33nF	4.7pF-68nF
25V	AEC-Q200	-	0.5pF-1.0nF	1.0pF-4.7nF	1.0pF-15nF	12nF-12nF	3.9pF-27nF	27nF- 33nF	4.7pF-27nF
	Standard	0.2pF- 220pF	0.5pF-2.2nF	1.0pF-10nF	1.0pF-27nF	12nF-12nF	3.9pF-56nF	27nF- 33nF	4.7pF-47nF
50V/63V	AEC-Q200	-	0.5pF-1.0nF	1.0pF-4.7nF	1.0pF-15nF	12nF-12nF	3.9pF-27nF	27nF- 33nF	4.7pF-27nF
	Standard	0.2pF-220pF	0.5pF-1.5nF	1.0pF-5.6nF	1.0pF-22nF	12nF-12nF	3.9pF-33nF	27nF- 33nF	4.7pF-33nF
100V	AEC-Q200	-	0.5pF-680pF	1.0pF-2.2nF	1.0pF-8.2nF	12nF-12nF	3.9pF-15nF	27nF- 33nF	4.7pF-15nF
	Standard	0.2pF-100pF	0.5pF-680pF	1.0pF-2.2nF	1.0pF-12nF	5.6nF-6.8nF	3.9pF-22nF	27nF- 33nF	4.7pF-18nF
200/250V	AEC-Q200	-	0.5pF-560pF	1.0pF-1.5nF	1.0pF-3.9nF	12nF-12nF	3.9pF-8.2nF	27nF- 33nF	4.7pF-8.2nF
	Standard	0.2pF-33pF	0.5pF-560pF	1.0pF-1.5nF	1.0pF-12nF	12nF-12nF	3.9pF-22nF	27nF- 33nF	4.7pF-8.2nF
500V	AEC-Q200	-	0.5pF-330pF	1.0pF-1.0nF	1.0pF-3.3nF	12nF-12nF	3.9pF-6.8nF	15nF- 33nF	4.7pF -6.8nF
	Standard	-	0.5pF-330pF	1.0pF-1.0nF	1.0pF-6.8nF	5.6nF-6.8nF	3.9pF-12nF	15nF- 33nF	4.7pF-8.2nF
630V	AEC-Q200	-	-	1.0pF-820pF	1.0pF-2.7nF	5.6nF-6.8nF	3.9pF-6.8nF	15nF- 33nF	4.7pF-6.8nF
	Standard	-	-	1.0pF-820pF	1.0pF-6.8nF	5.6nF-6.8nF	3.9pF-12nF	15nF- 33nF	4.7pF-8.2nF
1kV	AEC-Q200	-	-	1.0pF-330pF	1.0pF-2.2nF	2.7nF-2.7nF	3.9pF-3.9nF	8.2nF- 22nF	4.7pF-3.9nF
	Standard	-	-	1.0pF-330pF	1.0pF-2.7nF	2.7nF-2.7nF	3.9pF-6.8nF	8.2nF- 22nF	4.7pF-3.9nF
1.2kV	AEC-Q200	-	-	1.0pF-180pF	1.0pF-820pF	-	3.9pF-1.8nF	-	4.7pF-2.2nF
	Standard	-	-	1.0pF-180pF	1.0pF-820pF	-	3.9pF-1.8nF	-	4.7pF-2.2nF
1.5kV	AEC-Q200	-	-	1.0pF-150pF	1.0pF-560pF	-	3.9pF-1.2nF	-	4.7pF-1.5nF
	Standard	-	-	1.0pF-150pF	1.0pF-560pF	-	3.9pF-1.2nF	-	4.7pF-1.8nF
2kV	AEC-Q200	-	-	1.0pF-100pF	1.0pF -390pF	-	3.9pF-560pF	-	4.7pF-1.0nF
	Standard	-	-	1.0pF-100pF	1.0pF-390pF	-	3.9pF-560pF	-	4.7pF-1.0nF
2.5kV	AEC-Q200	-	-	-	10pF-150pF	-	3.9pF-330pF	-	4.7pF-390pF
	Standard	-	-	-	1.0pF-150pF	-	3.9pF-330pF	-	4.7pF-390pF
3kV	AEC-Q200	-	-	-	1.0pF-100pF	-	3.9pF-220pF	-	4.7pF-270pF
	Standard	-	-	-	1.0pF-100pF	-	3.9pF-220pF	-	4.7pF-270pF
4kV*	AEC-Q200	-	-	-	-	-	-	-	10pF-150pF
	Standard	-	-	-	-	-	-	-	4.7pF-150pF
5kV*	AEC-Q200	-	-	-	-	-	-	-	4.7pF-82pF
	Standard	-	-	-	-	-	-	-	4.7pF-82pF
6kV*	AEC-Q200	-	-	-	-	-	-	-	4.7pF-47pF
	Standard	-	-	-	-	-	-	-	4.7pF-47pF
8kV*	Standard	-	-	-	-	-	-	-	-
10kV*	Standard	-	-	-	-	-	-	-	-
12kV*	Standard	-	-	-	-	-	-	-	-

Notes:

- 1) *Parts rated 4kV and above may require conformal coating post soldering.
- 2) Standard parts are normally ordered using the Syfer order code system (see page 26), but are also available as Novacap parts using dielectric code RN (page 25). Note the RN nomenclature is being phased out and is not recommended for new designs, rather the Syfer brand part number should be used.



COG/NPO (1B) — AEC-Q200 and Standard Ranges

CONTINUED

10V TO 12KV

COG/NPO (1B)		1812		1825		2220	
Maximum Thickness (T)		2.5mm	3.2mm	2.5mm	4.0mm	2.5mm	4.0mm
10V	Standard	10pF-220nF	-	10pF - 470nF	-	10pF-470nF	-
16V	AEC-Q200	5.6pF-47nF	22nF-33nF	10pF-82nF	-	10pF-100nF	-
	Standard	5.6pF-180nF	22nF-33nF	10pF-330nF	-	10pF-330nF	-
25V	AEC-Q200	5.6pF-47nF	22nF-33nF	10pF-82nF	-	10pF-100nF	-
	Standard	5.6pF-150nF	22nF-33nF	10pF-220nF	-	10pF-220nF	-
50V/63V	AEC-Q200	5.6pF-47nF	22nF-33nF	10pF-82nF	-	10pF-100nF	-
	Standard	5.6pF-100nF	22nF-33nF	10pF-150nF	-	10pF-150nF	-
100V	AEC-Q200	5.6pF-39nF	22nF-33nF	10pF-47nF	-	10pF-56nF	-
	Standard	5.6pF-47nF	22nF-33nF	10pF-68nF	-	10pF-68nF	-
200V/250V	AEC-Q200	5.6pF-18nF	18nF-33nF	10pF-27nF	22nF-33nF	10pF-33nF	39nF-39nF
	Standard	5.6pF-22nF	18nF-33nF	10pF-33nF	22nF-47nF	10pF-33nF	39nF-56nF
500V	AEC-Q200	5.6pF-15nF	18nF-33nF	10pF-18nF	15nF-33nF	10pF-27nF	33nF-39nF
	Standard	5.6pF-15nF	18nF-33nF	10pF-27nF	15nF-33nF	10pF-27nF	27nF-39nF
630V	AEC-Q200	5.6pF-15nF	18nF-33nF	10pF-10nF	12nF-33nF	10pF-27nF	33nF-39nF
	Standard	5.6pF-15nF	12nF-33nF	10pF-22nF	12nF-33nF	10pF-27nF	22nF-39nF
1kV	AEC-Q200	5.6pF-6.8nF	8.2nF-10nF	10pF-10nF	10nF-22nF	10pF-15nF	18nF-22nF
	Standard	5.6pF-6.8nF	8.2nF-10nF	10pF-12nF	10nF-22nF	10pF-15nF	18nF-22nF
1.2kV	AEC-Q200	5.6pF-3.9nF	4.7nF-8.2nF	10pF-5.6nF	6.8nF-18nF	10pF-5.6nF	6.8nF-22nF
	Standard	5.6pF-4.7nF	4.7nF-8.2nF	10pF-6.8nF	6.8nF-18nF	10pF-10nF	6.8nF-22nF
1.5kV	AEC-Q200	5.6pF-3.9nF	4.7nF-6.8nF	10pF-5.6nF	6.8nF-12nF	10pF-5.6nF	6.8nF-15nF
	Standard	5.6pF-3.9nF	3.3nF-6.8nF	10pF-5.6nF	5.6nF-12nF	10pF-5.6nF	6.8nF-15nF
2kV	AEC-Q200	5.6pF-2.2nF	2.7nF-3.3nF	10pF-4.7nF	5.6nF-5.6nF	10pF-4.7nF	5.6nF-6.8nF
	Standard	5.6pF-2.2nF	1.8nF-3.3nF	10pF-4.7nF	3.3nF-5.6nF	10pF-4.7nF	3.9nF-6.8nF
2.5kV	AEC-Q200	5.6pF-680pF	820pF-1.5nF	10pF-1.2nF	1.5nF-3.3nF	10pF-1.5nF	1.8nF-3.9nF
	Standard	5.6pF-820pF	820pF-1.5nF	10pF-1.5nF	1.5nF-3.3nF	10pF-1.8nF	1.8nF-3.9nF
3kV	AEC-Q200	5.6pF-470pF	560pF-1.0nF	10pF-820pF	1.0nF-2.2nF	10pF-1.0nF	1.2nF-2.7nF
	Standard	5.6pF-560pF	560pF-1.0nF	10pF- 1.2nF	1.0nF-2.2nF	10pF-1.5nF	1.2nF-3.3nF
4kV*	AEC-Q200	5.6pF-220pF	270pF-680pF	10pF-680pF	820pF-1.5nF	10pF-680pF	820pF-1.8nF
	Standard	5.6pF-270pF	270pF-680pF	10pF-680pF	680pF-1.5nF	10pF-680pF	820pF-1.8nF
5kV*	AEC-Q200	5.6pF-180pF	220pF-330pF	10pF-330pF	390pF- 560pF	10pF-330pF	390pF-1.0pF
	Standard	5.6pF-180pF	220pF-330pF	10pF-390pF	390pF- 820pF	10pF-470pF	390pF-1.0nF
6kV*	AEC-Q200	5.6pF-150pF	180pF-220pF	10pF-180pF	220pF- 270pF	10pF-220pF	270p-330pF
	Standard	5.6pF-150pF	150pF-220pF	10pF-270pF	220pF- 330pF	10pF-330pF	270p-560pF
8kV*	Standard	-	-	-	-	-	-
10kV*	Standard	-	-	-	-	-	-
12kV*	Standard	-	-	-	-	-	-

Notes:

- 1) *Parts rated 4kV and above may require conformal coating post soldering.
- 2) Standard parts are normally ordered using the Syfer order code system (see page 26), but are also available as Novacap parts using dielectric code RN (page 25). Note the RN nomenclature is being phased out and is not recommended for new designs, rather the Syfer brand part number should be used.



COG/NPO (1B) – AEC-Q200 and Standard Ranges

10V TO 12KV

	COG/NPO (1B)	2225		3640		5550		8060	
	Maximum Thickness (T)	2.5mm	4.0mm	2.5mm	4.0mm	2.5mm	4.0mm	2.5mm	4.0mm
10V	Standard	10pF - 560nF	-	10pF - 330nF	-	-	-	-	-
16V	AEC-Q200	10pF - 150nF	-	10pF - 220nF	-	-	-	-	-
	Standard	10pF - 470nF	-	10pF - 330nF	100nF-100nF	-	-	-	-
25V	AEC-Q200	10pF - 150nF	-	10pF - 220nF	-	-	-	-	-
	Standard	10pF - 330nF	-	10pF - 330nF	100nF-100nF	-	-	-	-
50V/ 63V	AEC-Q200	10pF - 150nF	-	10pF - 220nF	-	-	-	-	-
	Standard	10pF - 220nF	-	10pF - 330nF	100nF-100nF	27pF - 680nF	-	47pF - 1.0μF	-
100V	AEC-Q200	10pF - 68nF	-	10pF - 180nF	100nF-100nF	-	-	-	-
	Standard	10pF - 82nF	-	10pF - 270nF	100nF-100nF	27pF - 470nF	-	47pF - 680nF	-
200V/ 250V	AEC-Q200	10pF - 33nF	39nF - 47nF	10pF - 82nF	100nF - 100nF	-	-	-	-
	Standard	10pF - 47nF	56nF - 68nF	10pF - 120nF	100nF - 180nF	27pF - 270nF	330nF - 330nF	47pF - 390nF	470nF - 560nF
500V	AEC-Q200	10pF - 33nF	39nF - 47nF	10pF - 82nF	100nF - 100nF	-	-	-	-
	Standard	10pF - 33nF	39nF - 47nF	10pF - 82nF	100nF - 120nF	27pF - 180nF	220nF - 270nF	47pF - 270nF	330nF - 470nF
630V	AEC-Q200	10pF - 18nF	22nF-39nF	10pF - 82nF	100nF - 100nF	-	-	-	-
	Standard	10pF - 22nF	27nF - 39nF	10pF - 82nF	82nF - 100nF	27pF - 120nF	150nF - 180nF	47pF - 220nF	270nF - 390nF
1kV	AEC-Q200	10pF - 18nF	22nF - 27nF	10pF - 47nF	56nF - 68nF	-	-	-	-
	Standard	10pF - 18nF	22nF - 27nF	10pF - 47nF	56nF - 82nF	27pF - 82nF	100nF - 150nF	47pF - 150nF	180nF - 270nF
1.2kV	AEC-Q200	10pF - 6.8nF	8.2nF - 27nF	10pF - 33nF	39nF - 56nF	-	-	-	-
	Standard	10pF - 12nF	15nF - 27nF	10pF - 33nF	39nF - 56nF	27pF - 68nF	82nF - 100nF	47pF - 100nF	120nF - 180nF
1.5kV	AEC-Q200	10pF - 6.8nF	8.2nF - 18nF	10pF - 22nF	27nF - 39nF	-	-	-	-
	Standard	10pF - 6.8nF	8.2nF - 18nF	10pF - 22nF	27nF - 39nF	27pF - 39nF	47nF - 68nF	47pF - 68nF	82nF - 120nF
2kV	AEC-Q200	10pF - 3.9nF	4.7nF - 8.2nF	10pF - 12nF	15nF - 15nF	-	-	-	-
	Standard	10pF - 4.7nF	5.6nF - 8.2nF	10pF - 12nF	12nF - 18nF	27pF - 22nF	27nF - 39nF	47pF - 39nF	47nF - 68nF
2.5kV	AEC-Q200	10pF - 2.7nF	3.3nF - 4.7nF	100pF - 5.6nF	6.8nF - 8.2nF	-	-	-	-
	Standard	10pF - 2.7nF	3.3nF - 4.7nF	10pF - 6.8nF	6.8nF - 12nF	27pF - 12nF	15nF - 22nF	47pF - 22nF	27nF - 39nF
3kV	AEC-Q200	10pF - 1.5nF	1.8nF - 3.9nF	100pF - 3.9nF	4.7nF - 6.8nF	-	-	-	-
	Standard	10pF - 1.8nF	2.2nF - 3.9nF	10pF - 4.7nF	4.7nF - 8.2nF	27pF - 10nF	12nF - 18nF	47pF - 15nF	18nF - 27nF
4kV*	AEC-Q200	10pF - 1.0nF	1.2nF - 1.8nF	100pF-1.8nF	2.2nF-3.3nF	-	-	-	-
	Standard	10pF - 1.0nF	1.2nF - 1.8nF	10pF - 1.8nF	2.2nF - 3.3nF	27pF - 4.7nF	5.6nF - 6.8nF	47pF - 8.2nF	10nF - 15nF
5kV*	AEC-Q200	10pF - 680pF	820pF - 1.2pF	100pF-1.2nF	1.5nF-2.2nF	-	-	-	-
	Standard	10pF - 680pF	820pF - 1.2nF	10pF - 1.5nF	1.8nF - 2.2nF	27pF - 2.7nF	3.3nF - 4.7nF	47pF - 5.6nF	6.8nF - 10nF
6kV*	AEC-Q200	10pF - 270pF	330pF - 390pF	100pF - 820nF	1.0nF - 1.5nF	27pF - 1.8nF	2.2nF - 3.3nF	47pF - 3.9nF	4.7nF - 6.8nF
	Standard	10pF - 390pF	470pF - 680pF	10pF - 1.0nF	1.0nF - 1.5nF	27pF - 1.8nF	2.2nF - 3.3nF	47pF - 3.9nF	4.7nF - 6.8nF
8kV*	Standard	-	-	10pF - 150pF	-	27pF - 330pF	-	47pF - 680pF	-
10kV*	Standard	-	-	10pF - 100pF	-	27pF - 180pF	-	47pF - 470pF	-
12kV*	Standard	-	-	10pF - 68pF	-	27pF - 120pF	-	47pF - 220pF	-

Notes:

- 1) *Parts rated 4kV and above may require conformal coating post soldering.
- 2) Standard parts are normally ordered using the Syfer order code system (see page 26), but are also available as Novacap parts using dielectric code RN (page 25). Note the RN nomenclature is being phased out and is not recommended for new designs, rather the Syfer brand part number should be used.



X7R (2R1) — AEC-Q200 and Standard Ranges

X7R (2R1) — AEC-Q200 AND STANDARD RANGES — CAPACITANCE VALUES

16V TO 12KV

	X7R(2R1)	0402	0603	0805	1206	1210	1808		
	Maximum Thickness (T)	0.6mm	0.9mm	1.3mm	1.7mm	1.91 mm	2.0mm	2.8mm	2.0mm
	Special Requirements	-	-	-	-	-	-	-	-
16V	AEC-Q200	-	-	100pF - 100nF	100pF - 470nF	-	1.0nF - 1.0µF	-	82pF - 470nF
	Standard	-	100pF - 100nF	100pF - 330nF	100pF - 1.0µF	-	100pF - 1.5µF	-	82pF - 1.5µF
25V	AEC-Q200	-	-	100pF - 100nF	100pF - 470nF	-	100nF - 1.0µF	-	82pF - 470nF
	Standard	47pF - 10nF	100pF - 100nF	100pF - 220nF	100pF - 820nF	-	100pF - 1.2µF	-	82pF - 1.2µF
50/ 63V	AEC-Q200	-	100pF - 100nF	100pF - 220nF	100pF - 470nF	-	100pF - 1.0µF	-	82pF - 680nF
	Standard	47pF - 5.6nF	100pF - 100nF	100pF - 220nF	100pF - 470nF	-	100pF - 1.0µF	-	82pF - 680nF
100V	AEC-Q200	-	100pF - 47nF	100pF - 100nF	100pF - 220nF	-	100pF - 680nF	-	82pF - 560nF
	Standard	47pF - 3.3nF	100pF - 47nF	100pF - 100nF	100pF - 330nF	-	100pF - 680nF	-	82pF - 560nF
200	AEC-Q200	-	100pF - 15nF	100pF - 56nF	100pF - 150nF	180nF - 220nF	100pF - 330nF	90nF - 560nF	82pF - 330nF
	Standard	47pF - 1.0nF	100pF - 15nF	100pF - 56nF	100pF - 150nF	180nF - 220nF	100pF - 330nF	90nF - 560nF	82pF - 330nF
250V	AEC-Q200	-	100pF - 15nF	100pF - 56nF	100pF - 150nF	150nF - 220nF	100pF - 330nF	-	82pF - 270nF
	Standard	47pF - 1.0nF	100pF - 15nF	100pF - 56nF	100pF - 150nF	150nF - 220nF	100pF - 330nF	-	82pF - 270nF
500V	AEC-Q200	-	100pF - 4.7nF	100pF - 22nF	100pF - 68nF	82nF - 100nF	100pF - 150nF	180nF - 220nF	82pF - 150nF
	Standard	-	100pF - 4.7nF	100pF - 22nF	100pF - 68nF	82nF - 100nF	100pF - 150nF	180nF - 220nF	82pF - 150nF
630V	AEC-Q200	-	-	220pF - 10nF	100pF - 47nF	82nF - 100nF	100pF - 100nF	120nF - 150nF	82pF - 100nF
	Standard	-	-	100pF - 10nF	100pF - 47nF	56nF - 68nF	100pF - 100nF	120nF - 150nF	82pF - 100nF
1kV	AEC-Q200	-	-	220pF - 10nF	100pF - 22nF	56nF - 68nF	100pF - 47nF	56F - 56nF	82pF - 47nF
	Standard	-	-	100pF - 10nF	100pF - 27nF	27nF - 33nF	100pF - 47nF	56nF - 56nF	82pF - 47nF
1.2kV	AEC-Q200	-	-	-	100pF - 10nF	27nF - 33nF	100pF - 22nF	27nF - 33nF	82pF - 22nF
	Standard	-	-	-	100pF - 15nF	12nF - 22nF	100pF - 22nF	27nF - 33nF	82pF - 22nF
1.5kV	AEC-Q200	-	-	-	100pF - 10nF	12nF - 22nF	100pF - 18nF	22nF - 22nF	82pF - 18nF
	Standard	-	-	-	100pF - 10nF	12nF - 12nF	100pF - 18nF	22nF - 22nF	82pF - 18nF
2kV	AEC-Q200	-	-	-	100pF - 2.2nF	3.9nF - 6.8nF	100pF - 5.6nF	6.8nF - 10nF	82pF - 8.2nF
	Standard	-	-	-	100pF - 2.2nF	3.9nF - 6.8nF	100pF - 5.6nF	6.8nF - 10nF	82pF - 8.2nF
2.5kV	AEC-Q200	-	-	-	100pF - 2.2nF	-	100pF - 4.7nF	-	82pF - 4.7nF
	Standard	-	-	-	220pF - 2.7nF	-	680pF - 4.7nF	-	82pF - 4.7nF
3kV	AEC-Q200	-	-	-	100pF - 1.5nF	-	100pF - 3.3nF	-	82pF - 3.9nF
	Standard	-	-	-	220pF - 1.5nF	-	680pF - 3.3nF	-	82pF - 3.9nF
4kV*	AEC-Q200	-	-	-	-	-	-	-	82pF - 2.2nF
	Standard	-	-	-	-	-	-	-	82pF - 2.2nF
5kV*	AEC-Q200	-	-	-	-	-	-	-	470pF - 680pF
	Standard	-	-	-	-	-	-	-	470pF - 680pF
6kV*	AEC-Q200	-	-	-	-	-	-	-	47pF - 390pF
	Standard	-	-	-	-	-	-	-	47pF - 390pF
8kV*	Standard	-	-	-	-	-	-	-	-
10kV*	Standard	-	-	-	-	-	-	-	-
12kV*	Standard	-	-	-	-	-	-	-	-

Notes:

- 1) *Parts rated 4kV and higher may require conformal coating post soldering.
- 2) "Conformal Coating" identifies parts that must be conformally coated after mounting to prevent flashover, especially between the board and the component.
- 3) Suffix codes WS2 and WS3 relate to StackiCap™ high capacitance parts. WS3 parts (shown in parentheses) must be conformally coated after mounting, especially between the board and the component.
- 4) Parts in this range may be dual use under export control legislation and as such may be subject to export license restrictions. Please refer to page 15 for more information on the dual-use regulations and contact the Knowles Precision Devices sales office for further information on specific part numbers.
- 5) Standard parts are normally ordered using the Syfer order code system (see page 26), but are also available as Novacap parts using dielectric code RB (see page 25). Note the RB nomenclature is being phased out and is not recommended for new designs, rather the Syfer brand part number should be used.



X7R (2R1) — AEC-Q200 and Standard Ranges

16V TO 12KV

	X7R(2R1)	1812			1825		2220		
	Maximum Thickness (T)	2.5mm	3.2mm	3.5mm	2.5mm	4.0mm	2.5mm	4.0mm	4.5mm
	Special Requirements	-	-	Suffix Code WS2 (WS3)	-	-	-	-	Suffix Code WS2 (WS3)
16V	AEC-Q200	100pF - 680nF	-	-	220nF - 680nF	-	150pF - 1.5μF	-	-
	Standard	100pF - 3.3μF	-	-	220pF - 4.7μF	-	150pF - 5.6μF	-	-
25V	AEC-Q200	100pF - 680nF	-	-	220nF - 680nF	-	150pF - 1.5μF	-	-
	Standard	100pF - 2.2μF	-	-	220pF - 3.9μF	-	150pF - 4.7μF	-	-
50/ 63V	AEC-Q200	100pF - 2.2μF	-	-	220pF - 2.2μF	-	150pF - 3.3μF	-	-
	Standard	100pF - 2.2μF	-	-	220pF - 2.2μF	-	150pF - 3.3μF	-	-
100V	AEC-Q200	100pF - 1.0μF	-	-	220pF - 1.5μF	-	150pF - 1.5μF	-	-
	Standard	100pF - 1.5μF	-	-	220pF - 1.5μF	-	150pF - 2.2μF	-	-
200	AEC-Q200	100pF - 680nF	680nF - 680nF	820nF - 1.0μF	220pF - 1.2μF	1.5μF - 1.5μF	150pF - 1.2μF	1.5μF - 1.5μF	1.8μF - 2.2μF
	Standard	100pF - 680nF	680nF - 680nF	820nF - 1.0μF	220pF - 1.2μF	1.5μF - 1.5μF	150pF - 1.5μF	1.5μF - 1.5μF	1.2μF - 2.2μF
250V	AEC-Q200	100pF - 680nF	680nF - 680nF	820nF - 1.0μF	220pF - 1.2μF	1.5μF - 1.5μF	150pF - 1.2μF	1.5μF - 1.5μF	1.8μF - 1.8μF
	Standard	100pF - 680nF	680nF - 680nF	820nF - 1.0μF	220pF - 1.2μF	1.5μF - 1.5μF	150pF - 1.5μF	1.5μF - 1.5μF	1.2μF - 2.2μF
500V	AEC-Q200	100pF - 390nF	-	390nF - 470nF	220pF - 560nF	-	150pF - 680nF	-	820nF - 1.0μF
	Standard	100pF - 390nF	-	390nF - 470nF	220pF - 560nF	-	150pF - 680nF	-	680nF - 1.2μF
630V	AEC-Q200	100pF - 220nF	-	180nF - 330nF	220pF - 470nF	-	150pF - 470nF	-	390nF - 1.0μF
	Standard	100pF - 220nF	-	220nF - 330nF	220pF - 470nF	-	150pF - 470nF	-	390nF - 1.0μF
1kV	AEC-Q200	100pF - 100nF	100nF - 100nF	120nF - 180nF	220pF - 180nF	220nF - 220nF	150pF - 180nF	220nF - 220nF	150nF - 470nF
	Standard	100pF - 100nF	100nF - 100nF	120nF - 180nF	220pF - 180nF	220nF - 220nF	150pF - 180nF	220nF - 220nF	150nF - 470nF
1.2kV	AEC-Q200	100pF - 39nF	47nF - 68nF	(39nF - 100nF)	220pF - 68nF	82nF - 120nF	150pF - 82nF	100nF - 120nF	(100nF - 220nF)
	Standard	100pF - 39nF	47nF - 68nF	(39nF - 100nF)	220pF - 68nF	82nF - 120nF	150pF - 82nF	-	(100nF - 220nF)
1.5kV	AEC-Q200	100pF - 33nF	39nF - 39nF	(27nF - 56nF)	220pF - 68nF	82nF - 82nF	150pF - 82nF	-	(56nF - 150nF)
	Standard	100pF - 33nF	39nF - 39nF	(27nF - 56nF)	220pF - 68nF	82nF - 82nF	150pF - 82nF	-	(56nF - 150nF)
2kV	AEC-Q200	100pF - 18nF	-	-	220pF - 22nF	-	150pF - 27nF	-	(39nF - 100nF)
	Standard	100pF - 18nF	-	-	220pF - 22nF	-	150pF - 33nF	-	(39nF - 100nF)
2.5kV	AEC-Q200	100pF - 10nF	-	-	220pF - 18nF	-	150pF - 22nF	-	-
	Standard	100pF - 10nF	-	-	220pF - 18nF	-	150pF - 22nF	-	-
3kV	AEC-Q200	100pF - 4.7nF	-	-	220pF - 10nF	-	150pF - 15nF	-	-
	Standard	100pF - 4.7nF	-	-	220pF - 10nF	-	150pF - 15nF	-	-
4kV*	AEC-Q200	100pF - 2.2nF	-	-	220pF - 2.2nF	-	150pF - 6.8nF	-	-
	Standard	100pF - 3.3nF	-	-	220pF - 2.2nF	-	150pF - 6.8nF	-	-
5kV*	AEC-Q200	100pF - 1.0nF	-	-	220pF - 1.8nF	2.2nF - 2.2nF	150pF - 2.7nF	3.3nF - 4.7nF	-
	Standard	100pF - 1.2nF	-	-	220pF - 1.8nF	2.2nF - 2.2nF	150pF - 2.7nF	3.3nF - 4.7nF	-
6kV*	AEC-Q200	100pF - 820pF	-	-	220pF - 1.0nF	1.2nF - 1.5nF	150pF - 1.0nF	-	-
	Standard	100pF - 820pF	-	-	220pF - 1.0nF	1.2nF - 1.5nF	150pF - 1.0nF	1.2nF - 2.2nF	-
8kV*	Standard	-	-	-	-	-	-	-	-
10kV*	Standard	-	-	-	-	-	-	-	-
12kV*	Standard	-	-	-	-	-	-	-	-

Notes:

- 1) *Parts rated 4kV and above may require conformal coating post soldering.
- 2) *"Conformal Coating" identifies parts that must be conformally coated after mounting to prevent flashover, especially between the board and the component.
- 3) Suffix codes WS2 and WS3 relate to StackiCap™ high capacitance parts. WS3 parts (shown in parentheses) must be conformally coated after mounting, especially between the board and the component.
- 4) Parts in this range may be dual use under export control legislation and as such may be subject to export license restrictions. Please refer to page 15 for more information on the dual-use regulations and contact the Knowles Precision Devices sales office for further information on specific part numbers.
- 5) Standard parts are normally ordered using the Syfer order code system (see page 26), but are also available as Novacap parts using dielectric code RB (see page 25). Note the RB nomenclature is being phased out and is not recommended for new designs, rather the Syfer brand part number should be used.



X7R (2R1) — AEC-Q200 and Standard Ranges

CONTINUED

16V TO 12KV

	X7R(2R1)	2225			3640		5550	8060
	Maximum Thickness	2.5mm	4.0mm	4.5mm	2.5mm	4.5mm	2.5mm	2.5mm
	Special Requirements	-	-	Suffix Code WS2 (WS3)	-	Suffix Code WS2 (WS3)	-	-
16V	AEC-Q200	-	-	-	-	-	-	-
	Standard	330pF - 6.8µF	-	-	-	-	-	-
25V	AEC-Q200	-	-	-	-	-	-	-
	Standard	330pF - 5.6µF	-	-	-	-	-	-
50/ 63V	AEC-Q200	330pF - 3.3µF	-	-	470pF - 4.7µF	-	-	-
	Standard	330pF - 3.3µF	-	-	470pF - 10µF	-	1.0nF - 15µF	2.2nF - 22µF
100V	AEC-Q200	330pF - 2.2µF	-	-	470pF - 3.3µF	-	-	-
	Standard	330pF - 2.7µF	-	-	470pF - 5.6µF	-	1.0nF - 10µF	2.2nF - 15µF
200	AEC-Q200	330pF - 1.5µF	1.8µF - 1.8µF	2.2µF - 2.2µF	470pF - 3.3µF	-	-	-
	Standard	330pF - 1.5µF	1.8µF - 1.8µF	2.2µF - 2.2µF	470pF - 3.3µF	3.9µF - 5.6µF	1.0nF - 5.6µF	2.2nF - 10µF
250V	AEC-Q200	330pF - 1.5µF	1.8µF - 1.8µF	2.2µF - 2.2µF	470pF - 3.3µF	-	-	-
	Standard	330pF - 1.5µF	1.8µF - 1.8µF	2.2µF - 2.2µF	470pF - 3.3µF	3.9µF - 5.6µF	1.0nF - 5.6µF	2.2nF - 10µF
500V	AEC-Q200	330pF - 1.0µF	-	1.2µF - 1.2µF	470pF - 1.2µF	-	-	-
	Standard	330pF - 1.0µF	-	1.2µF - 1.2µF	470pF - 1.2µF	1.2µF - 2.7µF	1.0nF - 1.8µF	2.2nF - 3.3µF
630V	AEC-Q200	330pF - 680nF	-	820nF - 1.0µF	470pF - 680nF	-	-	-
	Standard	330pF - 680nF	-	820nF - 1.0µF	470pF - 680nF	820nF - 2.2µF	1.0nF - 1.2µF	2.2nF - 2.2µF
1kV	AEC-Q200	330pF - 220nF	270nF - 270nF	-	470nF - 220nF	220nF - 1.0µF	-	-
	Standard	330pF - 220nF	270nF - 270nF	-	470pF - 220nF	220nF - 1.0µF	1.0nF - 390nF	2.2nF - 1.0µF
1.2kV	AEC-Q200	330pF - 100nF	120nF - 150nF	-	470pF - 180nF	-	-	-
	Standard	330pF - 100nF	120nF - 150nF	-	470pF - 180nF	(180nF - 470nF)	1.0nF - 220nF	2.2nF - 470nF
1.5kV	AEC-Q200	330pF - 100nF	-	-	470pF - 100nF	-	-	-
	Standard	330pF - 100nF	-	-	470pF - 100nF	(120nF - 330nF)	1.0nF - 150nF	2.2nF - 330nF
2kV	AEC-Q200	330pF - 47nF	56nF - 56nF	-	470pF - 56nF	-	-	-
	Standard	330pF - 47nF	56nF - 56nF	-	470pF - 56nF	(56nF - 150nF)	1.0nF - 82nF	2.2nF - 150nF
2.5kV	AEC-Q200	330pF - 33nF	-	-	470pF - 39nF	-	-	-
	Standard	330pF - 33nF	-	-	470pF - 39nF	-	1.0nF - 68nF	2.2nF - 100nF
3kV	AEC-Q200	330pF - 18nF	-	-	470pF - 33nF	-	-	-
	Standard	330pF - 18nF	-	-	470pF - 33nF	-	1.0nF - 47nF	2.2nF - 82nF
4kV*	AEC-Q200	330pF - 10nF	-	-	1.0nF - 10nF	-	-	-
	Standard	330pF - 10nF	-	-	470pF - 10nF	-	1.0nF - 15nF	2.2nF - 33nF
5kV*	AEC-Q200	330pF - 3.9nF	4.7nF - 5.6nF	-	1.0nF - 6.8nF	-	-	-
	Standard	330pF - 4.7nF	4.7nF - 5.6nF	-	470pF - 6.8nF	-	1.0nF - 10nF	2.2nF - 22nF
6kV*	AEC-Q200	330pF - 1.5nF	1.8nF - 2.7nF	-	1.0nF - 4.7nF	-	-	-
	Standard	330pF - 2.7nF	1.8nF - 2.7nF	-	470pF - 4.7nF	-	1.0nF - 8.2nF	2.2nF - 15nF
8kV*	Standard	-	-	-	470pF - 1.5nF	-	1.0nF - 4.7nF	2.2nF - 6.8nF
10kV*	Standard	-	-	-	470pF - 1.0nF	-	1.0nF - 2.2nF	2.2nF - 4.7nF
12kV*	Standard	-	-	-	470pF - 820pF	-	1.0nF - 1.2nF	2.2nF - 2.2nF

Notes:

- 1) *Parts rated 4kV and above may require conformal coating post soldering.
- 2) "Conformal Coating" identifies parts that must be conformally coated after mounting to prevent flashover, especially between the board and the component.
- 3) Suffix codes WS2 and WS3 relate to StackiCap™ high capacitance parts. WS3 parts (shown in parentheses) must be conformally coated after mounting, especially between the board and the component.

- 4) Parts in this range may be dual use under export control legislation and as such may be subject to export license restrictions. Please refer to page 15 for more information on the dual-use regulations and contact the Knowles Precision Devices sales office for further information on specific part numbers.
- 5) Standard parts are normally ordered using the Syfer order code system (see page 26), but are also available as Novacap parts using dielectric code RB (see page 25). Note the RB nomenclature is being phased out and is not recommended for new designs, rather the Syfer brand part number should be used.



Ordering Information — AEC-Q200 and Standard Ranges

ORDERING INFORMATION — AEC-Q200 RANGES

0805	Y	100	0103	K	S	T	---
Chip Size	Termination	Voltage	Capacitance in Picofarads (pF)	Capacitance Tolerance	Dielectric Release Codes	Packaging	Suffix Code
0603	Y = FlexiCap™ termination base with Ni barrier (100% matte tin plating). RoHS compliant.	016 = 16V	First digit is 0. Second and third digits are significant figures of capacitance code. The fourth digit is number of zeros following Example: 0103 = 10nF	B = ± 0.1pF C = ± 0.25pF D = ± 0.5pF F = ±1% G = ±2% J = ±5% K = ±10% M = ±20% Note: X7R (2R1) parts are available in J, K & M tolerances only.	A = COG/NPO (1B) to AEC-Q200 — original K = COG/NPO (1B) to AEC-Q200 — recommended E = X7R (2R1) to AEC-Q200 — original S = X7R (2R1) to AEC-Q200 — recommended	T = 178mm (7") reel R = 330mm (13") reel B = Bulk pack — tubs or trays	For StackiCap™ parts only: WS2 WS3
0805	H = FlexiCap™ termination base with Ni barrier (Tin/lead plating with min. 10% lead). Not RoHS compliant.	025 = 25V					
1206	J = Nickel barrier (100% matte tin plating). RoHS compliant. Lead free.	050 = 50V					
1210	A = Nickel barrier (Tin/lead plating with min. 10% lead). Not RoHS compliant	063 = 63V					
1808	6 = Nickel Barrier, Sn/Pb Plated Solder (5-20% Lead, non RoHS)	100 = 100V					
1812	7 = FlexiCap™ Polymer termination, Nickel barrier, Sn/Pb Plated Solder (5-20% Lead, non RoHS)	200 = 200V					
1825	Note: X7R (2R1) to AEC-Q200 is only available in Y or H termination.	250 = 250V					
2220		630 = 630V					
2225		1K0 = 1kV					
3640		1K2 = 1.2kV					
		1K5 = 1.5kV					
		2K0 = 2kV					
		2K5 = 2.5kV					
		3K0 = 3kV					

Note: Suffix code WS3 applies to StackiCap™ parts rated ≥1.2kV, and indicates conformal coating is required after mounting. For StackiCap™ parts rated <1.2kV, use suffix WS2.

ORDERING INFORMATION — STANDARD RANGES

1210	Y	200	0103	K	C	T	---
Chip Size	Termination	Voltage	Capacitance in Picofarads (pF)	Capacitance Tolerance	Dielectric Release Codes	Packaging	Suffix Code
0402	Y = FlexiCap™ termination base with Ni barrier (100% matte tin plating). RoHS compliant.	010 = 10V	First digit is 0. Second and third digits are significant figures of capacitance code. The fourth digit is number of zeros following Example: 0103 = 10nF	B = ± 0.1pF C = ± 0.25pF D = ± 0.5pF F = ±1% G = ±2% J = ±5% K = ±10% M = ±20% Note: X7R (2R1) parts are available in J, K & M tolerances only.	C = COG/NPO (1B) X = X7R (2R1)	T = 178mm (7") reel R = 330mm (13") reel B = Bulk pack — tubs or trays	For StackiCap™ parts only: WS2 WS3
0603	H = FlexiCap™ termination base with Ni barrier (Tin/lead plating with min. 10% lead). Not RoHS compliant.	016 = 16V					
0805	J = Nickel barrier (100% matte tin plating). RoHS compliant. Lead free.	025 = 25V					
1206	A = Nickel barrier (Tin/lead plating with min. 10% lead). Not RoHS compliant.	050 = 50V					
1210	6 = Nickel Barrier, Sn/Pb Plated Solder (5-20% Lead, non RoHS)	063 = 63V					
1808	7 = FlexiCap™ Polymer termination, Nickel barrier, Sn/Pb Plated Solder (5-20% Lead, non RoHS)	100 = 100V					
1812		200 = 200V					
1825		250 = 250V					
2220		500 = 500V					
2225		630 = 630V					
3640		1K0 = 1kV					
5550		1K2 = 1.2kV					
8060		1K5 = 1.5kV					
		2K0 = 2kV					
		2K5 = 2.5kV					
		3K0 = 3kV					
		4K0 = 4kV					
		5K0 = 5kV					
		6K0 = 6kV					
		8K0 = 8kV					
		10K = 10kV					
		12K = 12kV					

Notes:

- 1) Suffix code WS3 applies to StackiCap™ parts rated ≥1.2kV, and indicates conformal coating is required after mounting. For StackiCap™ parts rated <1.2kV, use suffix WS2.
- 2) Standard parts are normally ordered using the Syfer order code system (see page 26), but are also available as Novacap parts using dielectric codes RN and RB (see page 25). Note the RN and RB nomenclature is being phased out and is not recommended for new designs, rather the Syfer brand part number should be used.



Novacap Range (Lead-Containing)

COG/NPO (1B) NOVACAP BRAND N RANGE – CAPACITANCE VALUES

COG/NPO (1B)	0402	0504	0603	0805	1005	1206	1210	1515	1808		1812		1825	
Max. T.	0.6mm	1.12mm	0.89mm	1.37mm	1.37mm	1.63mm	1.65mm	3.3mm	1.65mm	2.03mm	1.65mm	2.5mm	2.03mm	3.56mm
Min. Cap.	0.3pF	0.5pF	0.3pF	0.5pF	0.5pF	3.3pF	5.6pF	3.3pF	5.6pF	5.6pF	10pF	10pF	15pF	15pF
16V	270pF	2.2nF	1.5nF	5.6nF	8.2nF	15nF	27nF	47nF	39nF	39nF	56nF	56nF	100nF	100nF
25V	220pF	1.8nF	1.2nF	4.7nF	6.8nF	12nF	27nF	39nF	33nF	33nF	56nF	56nF	100nF	100nF
50V	180pF	1.5nF	1.0nF	3.9nF	5.6nF	12nF	22nF	33nF	22nF	27nF	39nF	39nF	100nF	100nF
100V	180pF	1.5nF	1.0nF	3.9nF	5.6nF	10nF	18nF	33nF	15nF	22nF	27nF	39nF	68nF	82nF
200V	100pF	820pF	560pF	1.8nF	2.7nF	5.6nF	10nF	22nF	10nF	15nF	18nF	27nF	47nF	68nF
250V	56pF	560pF	330pF	1.5nF	2.2nF	3.9nF	8.2nF	22nF	6.8nF	10nF	15nF	22nF	39nF	56nF
300V	-	-	-	820pF	1.2nF	2.7nF	4.7nF	15nF	5.6nF	10nF	15nF	22nF	39nF	47nF
400V	-	-	-	820pF	1.2nF	1.8nF	4.7nF	10nF	4.7nF	4.7nF	10nF	12nF	22nF	33nF
500V	-	-	-	820pF	1.2nF	1.8nF	3.9nF	8.2nF	4.7nF	4.7nF	10nF	12nF	22nF	27nF
600V	-	-	-	680pF	1.0nF	1.5nF	3.3nF	6.8nF	3.9nF	4.7nF	8.2nF	10nF	18nF	18nF
800V	-	-	-	680pF	1.0nF	1.5nF	3.3nF	6.8nF	3.9nF	4.7nF	8.2nF	10nF	18nF	18nF
1000V	-	-	-	470pF	390pF	1.0nF	2.2nF	5.6nF	2.2nF	3.3nF	4.7nF	8.2nF	10nF	15nF
1500V	-	-	-	-	-	560pF	1.2nF	3.9nF	1.2nF	1.8nF	2.7nF	4.7nF	5.6nF	10nF
2000V	-	-	-	-	-	390pF	820pF	2.7nF	820pF	1.2nF	1.8nF	2.7nF	2.7nF	5.6nF
3000V	-	-	-	-	-	-	-	1.2nF	390pF	470pF	820pF	1.2nF	1.2nF	2.2nF
4000V	-	-	-	-	-	-	-	680pF	270pF	270pF	470pF	680pF	680pF	1.2nF
5000V	-	-	-	-	-	-	-	-	-	-	-	-	390pF	820pF

COG/NPO (1B)	2020	2221	2225		2520	3333	3530	4040	4540	5440	5550	6560	7565
Max. T.	4.57mm	2.03mm	2.03mm	3.81mm	4.57mm	6.35mm	6.35mm	7.62mm	7.62mm	7.62mm	7.62mm	7.62mm	7.62mm
Min. Cap.	27pF	27pF	27pF	27pF	39pF	39pF	39pF	39pF	39pF	39pF	39pF	56pF	100pF
16V	68nF	100nF	120nF	120nF	100nF	180nF	180nF	330nF	330nF	390nF	390nF	680nF	820nF
25V	68nF	100nF	120nF	120nF	100nF	180nF	180nF	330nF	330nF	390nF	390nF	680nF	820nF
50V	68nF	100nF	120nF	120nF	100nF	150nF	180nF	270nF	330nF	390nF	390nF	680nF	820nF
100V	56nF	68nF	82nF	100nF	82nF	120nF	150nF	220nF	270nF	270nF	270nF	470nF	560nF
200V	56nF	47nF	56nF	82nF	68nF	100nF	120nF	180nF	220nF	270nF	270nF	470nF	560nF
250V	47nF	39nF	47nF	68nF	56nF	100nF	120nF	180nF	180nF	220nF	220nF	390nF	470nF
300V	39nF	22nF	27nF	56nF	47nF	82nF	100nF	150nF	180nF	220nF	220nF	390nF	470nF
400V	33nF	22nF	27nF	39nF	39nF	56nF	82nF	120nF	150nF	180nF	180nF	330nF	390nF
500V	27nF	22nF	27nF	33nF	39nF	47nF	68nF	100nF	120nF	150nF	180nF	270nF	330nF
600V	15nF	18nF	27nF	27nF	22nF	39nF	39nF	82nF	82nF	100nF	150nF	220nF	270nF
800V	15nF	18nF	27nF	27nF	18nF	33nF	33nF	56nF	68nF	82nF	120nF	180nF	220nF
1000V	10nF	10nF	15nF	22nF	12nF	27nF	27nF	56nF	56nF	68nF	100nF	150nF	180nF
1500V	8.2nF	5.6nF	8.2nF	15nF	10nF	18nF	22nF	39nF	39nF	39nF	56nF	82nF	120nF
2000V	4.7nF	2.7nF	3.9nF	8.2nF	5.6nF	15nF	15nF	27nF	33nF	33nF	47nF	68nF	100nF
3000V	2.2nF	1.2nF	1.8nF	3.3nF	2.7nF	8.2nF	10nF	18nF	22nF	22nF	33nF	47nF	68nF
4000V	1.2nF	680pF	1.0nF	1.8nF	1.5nF	3.3nF	5.6nF	12nF	12nF	12nF	18nF	27nF	39nF
5000V	820pF	390pF	560pF	1.2nF	1.0nF	2.2nF	3.3nF	6.8nF	8.2nF	8.2nF	12nF	18nF	22nF
6000V	-	-	-	-	-	1.8nF	1.8nF	3.9nF	3.9nF	4.7nF	5.6nF	10nF	12nF
7000V	-	-	-	-	-	-	1.2nF	2.7nF	2.7nF	3.3nF	4.7nF	6.8nF	8.2nF
8000V	-	-	-	-	-	-	1.0nF	2.2nF	2.2nF	2.7nF	3.3nF	5.6nF	6.8nF
9000V	-	-	-	-	-	-	820pF	1.5nF	1.8nF	1.8nF	2.7nF	3.9nF	4.7nF
10000V	-	-	-	-	-	-	680pF	1.2nF	1.5nF	1.5nF	2.2nF	3.3nF	3.9nF

Order using Novacap dielectric code N (see page 25). Lead-free alternatives are available using Syfer Brand.



Novacap Range (Lead-Containing)

X7R (2R1) NOVACAP BRAND B RANGE — CAPACITANCE VALUES

X7R (2R1)	0402	0504	0603	0805	1005	1206	1210	1515	1808		1812		1825	
Max. T.	0.6mm	1.12mm	0.89mm	1.37mm	1.37mm	1.63mm	1.65mm	3.3mm	1.65mm	2.03mm	1.65mm	2.5mm	2.03mm	3.56mm
Min. Cap.	120pF	120pF	120pF	120pF	120pF	120pF	120pF	150pF	150pF	150pF	150pF	150pF	470pF	470pF
16V	5.6nF	39nF	27nF	120nF	150nF	330nF	470nF	1.2uF	680nF	820nF	1.2uF	1.5uF	1.8uF	2.2uF
25V	4.7nF	33nF	22nF	100nF	120nF	270nF	470nF	1.0uF	560nF	560nF	1.0uF	1.2uF	1.5uF	2.2uF
50V	4.7nF	33nF	22nF	100nF	120nF	270nF	470nF	820nF	390nF	560nF	820nF	1.2uF	1.5uF	2.2uF
100V	4.7nF	33nF	22nF	68nF	82nF	180nF	330nF	680nF	270nF	390nF	560nF	820nF	1.2uF	1.8uF
200V	2.2nF	15nF	10nF	33nF	47nF	100nF	180nF	560nF	180nF	220nF	330nF	560nF	820nF	1.5uF
250V	1.5nF	10nF	6.8nF	27nF	39nF	68nF	120nF	390nF	120nF	150nF	220nF	390nF	680nF	1.2uF
300V	-	-	-	15nF	18nF	47nF	82nF	270nF	82nF	100nF	150nF	220nF	470nF	820nF
400V	-	-	-	12nF	12nF	27nF	56nF	220nF	56nF	82nF	100nF	180nF	330nF	560nF
500V	-	-	-	12nF	8.2nF	22nF	56nF	150nF	56nF	68nF	100nF	150nF	330nF	470nF
600V	-	-	-	8.2nF	8.2nF	18nF	39nF	120nF	39nF	56nF	68nF	120nF	220nF	390nF
800V	-	-	-	4.7nF	4.7nF	10nF	27nF	82nF	27nF	33nF	47nF	68nF	120nF	270nF
1000V	-	-	-	2.7nF	2.7nF	6.8nF	15nF	56nF	15nF	22nF	27nF	47nF	82nF	150nF
1500V	-	-	-	-	-	2.2nF	4.7nF	18nF	4.7nF	6.8nF	8.2nF	15nF	27nF	56nF
2000V	-	-	-	-	-	1.0nF	2.2nF	8.2nF	2.7nF	3.3nF	4.7nF	6.8nF	12nF	27nF
3000V	-	-	-	-	-	-	-	1.5nF	560pF	820pF	1.2nF	2.2nF	2.7nF	4.7nF
4000V	-	-	-	-	-	-	-	1.2nF	390pF	390pF	680pF	1.2nF	1.5nF	2.7nF
5000V	-	-	-	-	-	-	-	-	-	-	-	-	820pF	1.8nF

X7R (2R1)	2020	2221	2225		2520	3333	3530	4040	4540	5440	5550	6560	7565
Max. T.	4.57mm	2.03mm	2.03mm	3.81mm	4.57mm	6.35mm	6.35mm	7.62mm	7.62mm	7.62mm	7.62mm	7.62mm	7.62mm
Min. Cap.	470pF	470pF	470pF	470pF	1.0nF	1.0nF	1.0nF	1.0nF	1.0nF	1.0nF	1.0nF	2.2nF	2.2nF
16V	1.8uF	1.5uF	2.2uF	2.7uF	3.3uF	4.7uF	4.7uF	8.2uF	8.2uF	10uF	12uF	18uF	22uF
25V	1.5uF	1.2uF	1.8uF	2.2uF	2.7uF	4.7uF	4.7uF	6.8uF	6.8uF	10uF	10uF	18uF	22uF
50V	1.5uF	1.2uF	1.8uF	2.2uF	2.7uF	3.9uF	3.9uF	6.8uF	6.8uF	8.2uF	10uF	15uF	18uF
100V	1.5uF	1.2uF	1.5uF	2.2uF	2.7uF	3.9uF	3.9uF	5.6uF	6.8uF	8.2uF	8.2uF	12uF	18uF
200V	1.2uF	680nF	1.0uF	1.8uF	2.2uF	3.3uF	3.3uF	5.6uF	5.6uF	6.8uF	8.2uF	8.2uF	15uF
250V	1.0uF	560nF	820nF	1.5nF	1.8uF	2.7uF	2.7uF	4.7uF	5.6uF	6.8uF	6.8uF	8.2uF	12uF
300V	820nF	390nF	470nF	1.0uF	1.2uF	2.2uF	2.2uF	4.7uF	4.7uF	5.6uF	6.8uF	6.8uF	10uF
400V	560nF	270nF	390nF	680nF	820nF	1.2uF	1.2uF	2.2uF	2.7uF	2.7uF	3.3uF	4.7uF	8.2uF
500V	470nF	270nF	330nF	560nF	680nF	1.0uF	1.0uF	1.8uF	1.8uF	1.8uF	2.2uF	3.3uF	4.7uF
600V	270nF	220nF	270nF	470nF	390nF	680nF	680nF	1.5uF	1.5uF	1.5uF	2.2uF	2.7uF	3.9uF
800V	220nF	120nF	150nF	330nF	270nF	470nF	390nF	680nF	820nF	1.0uF	1.5uF	2.2uF	2.7uF
1000V	150nF	82nF	100nF	220nF	180nF	330nF	330nF	560nF	680nF	680nF	1.0uF	1.5uF	1.8uF
1500V	39nF	27nF	33nF	68nF	56nF	120nF	120nF	270nF	330nF	330nF	470nF	680nF	820nF
2000V	27nF	12nF	15nF	33nF	27nF	82nF	68nF	150nF	180nF	180nF	270nF	390nF	470nF
3000V	4.7nF	2.7nF	3.3nF	6.8nF	8.2nF	33nF	27nF	47nF	56nF	68nF	82nF	120nF	180nF
4000V	2.7nF	1.5nF	1.5nF	3.3nF	4.7nF	18nF	15nF	22nF	33nF	39nF	47nF	82nF	100nF
5000V	1.5nF	820pF	1.0nF	2.2nF	2.7nF	12nF	10nF	12nF	18nF	22nF	33nF	47nF	56nF
6000V	-	-	-	-	-	6.8nF	5.6nF	8.2nF	12nF	15nF	22nF	33nF	39nF
7000V	-	-	-	-	-	4.7nF	4.7nF	5.6nF	8.2nF	10nF	15nF	22nF	27nF
8000V	-	-	-	-	-	-	3.3nF	4.7nF	6.8nF	8.2nF	12nF	15nF	22nF
9000V	-	-	-	-	-	-	2.7nF	3.3nF	4.7nF	5.6nF	10nF	12nF	18nF
10000V	-	-	-	-	-	-	1.8nF	2.7nF	3.9nF	4.7nF	6.8nF	10nF	12nF

Order using Novacap dielectric code B (see page 25). Lead-free alternatives are available using Syfer Brand.



Standard Chip — BX

Manufactured with layer thickness, and minimal voltage coefficient, to meet BX requirements. BX characteristics are identical to X7R dielectric with the added restriction that the Temperature-Voltage Coefficient (TVC) does not exceed -25% at rated voltage, over -55°C to +125°C operating temperature.

High Reliability Testing available: HB = MIL-PRF-55681 Group A.
HK = MIL-PRF-38534 Class K. HS = MIL-PRF-123 Group A.

- For dimensions, see page 23.
- For termination types, see page 9.
- For ordering information, see page 25.



CAPACITANCE AND VOLTAGE SELECTION — BX

Size	0402	0504	0603	0805	1005	1206	1210	1808	1812	1825	2221	2225
Min cap.	120pF	120pF	120pF	120pF	120pF	120pF	120pF	150pF	150pF	470pF	470pF	470pF
16V	5.6nF	39nF	27nF	100nF	120nF	270nF	470nF	560nF	1.0μF	1.8μF	1.5μF	2.2μF
25V	4.7nF	33nF	22nF	100nF	120nF	270nF	470nF	560nF	1.0μF	1.5μF	1.2μF	1.8μF
50V	1.8nF	18nF	12nF	47nF	68nF	120nF	270nF	270nF	560nF	1.2μF	1.2μF	1.5μF
100V	680pF	6.8nF	4.7nF	18nF	18nF	47nF	100nF	100nF	180nF	390nF	330nF	470nF
200V	220pF	1.8nF	1.2nF	5.6nF	8.2nF	15nF	27nF	33nF	56nF	100nF	82nF	120nF
250V	-	680pF	390pF	1.8nF	2.7nF	4.7nF	10nF	10nF	22nF	56nF	47nF	68nF
300V	-	-	-	1.2nF	1.2nF	3.2nF	5.6nF	6.8nF	12nF	39nF	33nF	47nF
400V	-	-	-	680pF	680pF	1.8nF	3.3nF	3.9nF	5.6nF	18nF	18nF	22nF
500V	-	-	-	390pF	470pF	1.0nF	2.2nF	2.2nF	3.9nF	12nF	10nF	15nF



Improved ESR Capacitors — BX and X7R

A range of commercial MLC chip capacitors with improved ESR performance. This series has been designed for rugged environments in high power broadband coupling and switching power supplies. The Class II ceramic dielectric (BX or X7R, dependant on chip size) affords high volumetric efficiency with negligible piezoelectric effects.

Please consult the Knowles Precision Devices Sales Office if your specific requirement exceeds our catalog maximums (size, capacitance value and voltage).

- For dimensions, see page 23.
- Termination options:
 P = Palladium/Silver
 N = Nickel barrier 100% Tin (RoHS)
 Y = Nickel barrier 90% Tin/10% Lead
 B = Copper barrier 100% Tin (RoHS)
 E = Copper barrier 90% Tin/10% Lead
- Capacitance tolerances available $\pm 10\%$, $\pm 20\%$
- For ordering information, see page 25.

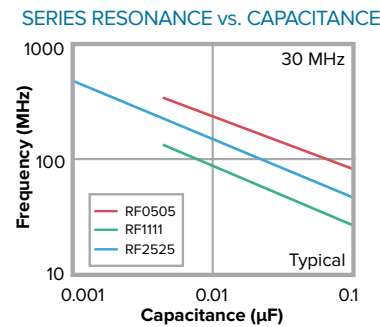
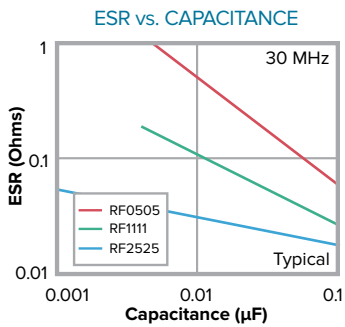
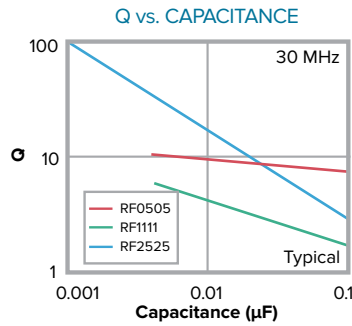
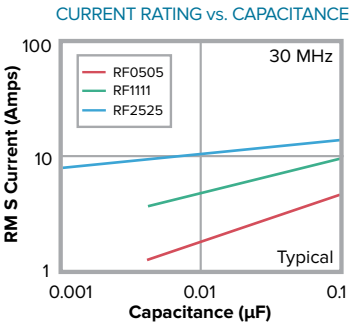

CAPACITANCE AND VOLTAGE SELECTION — BX

Size	RF0505	RF1111	RF2525				
Tmax mm ~ inches:	0.057 ~ 1.45*	0.102 ~ 2.59*	0.165 ~ 4.19*				
Dielectric	BX	BX	X7R				
Rated Voltage	50	50	100	150	200	250	300
470pF	●						
560pF	●						
680pF	●						
820pF	●						
1.0nF	●						
1.2nF	●						
1.5nF	●						
1.8nF	●						
2.2nF	●						
2.7nF	●						
3.3nF	●						
3.9nF	●						
4.7nF	●	●					
5.0nF	●	●					
5.6nF	●	●					
6.8nF	●	●					
8.2nF	●	●					
10nF	●	●					●
12nF		●					●
15nF		●					●
18nF		●					●
22nF		●					●
27nF		●					
33nF		●					●
39nF		●					●
47nF		●					●
50nF		●					
56nF		●					
68nF		●					●
82nF		●					
100nF		●					
120nF							
150nF							
220nF							
330nF							
470nF							
560nF							
680nF							
820nF							
1.0µF							

Note: *Denotes non standard chip thickness. Order code needs to have an "X" inserted together with the dimension in inches; e.g., X057 where dimension is 0.057".



Pulse Energy Capacitors

These high temperature, high energy, capacitors are manufactured with a dielectric formulation designed for reliable operation under single or multiple pulse firing applications. Energy density exceeds that of conventional Class 1 materials and offers excellent short duration pulse delivery at temperatures to 200°C. Discharge pulse width which is typically less than 100 nanoseconds will vary with load conditions which are influenced by inductive and resistive load components.

All parts are 100% tested to High Reliability Pulse Screening tests and are evaluated at temperature extremes up to 200°C consistent with munitions and oil field exploration/ seismic detonation conditions.

As an added safety feature, these pulse discharge capacitors can be supplied with integral bleed resistors at various resistance values. With exceptionally low ESR and low signal distortion, additional applications at high temperature include power supply filtering, energy storage and coupling/decoupling.

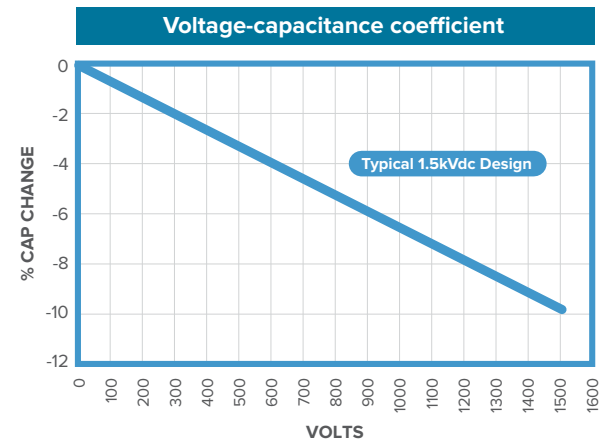
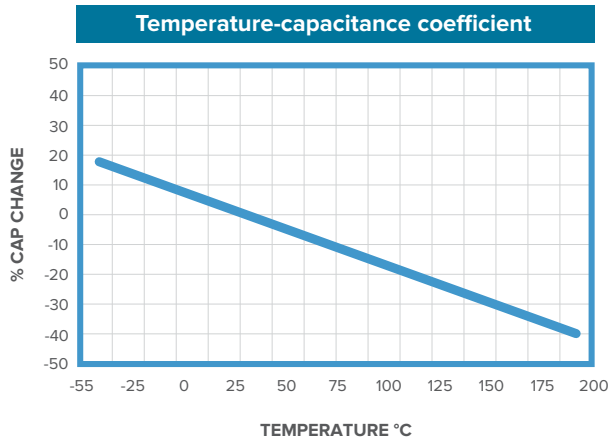
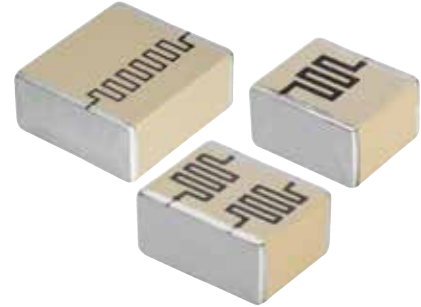

FUNCTIONAL APPLICATIONS

- Military detonation
- Down hole detonation
- Rocket ignition

BENEFITS

- Small size
- More energy in cold temperature detonation
- Low ESR
- Low Inductance

DIELECTRIC CHARACTERISTICS - PULSE ENERGY (R)

Operating temperature range:	-55°C to 200°C
Temperature coefficient:	+25°C to +200°C -2200 ppm/°C ±500 ppm/°C +25°C to -55°C -3330 to -1700 ppm/°C
Dissipation factor @ 25°C:	0.1% Max.
Insulation resistance	
@ 25°C:	>100GW or >1000WF whichever is less
@ 200°C:	>1GW or >10WF whichever is less
Dielectric withstanding voltage:	120%
Ageing rate:	0% per decade
Test parameters:	1KHz, 1.0 ±0.2 VRMS, 25°C



Pulse Energy Capacitors

SPECIFICATIONS- PULSE ENERGY (R)

Size	2225	3040	3640	4040	5550	6560	7565
Length L	0.220/5.59 ±0.015/0.381	0.300/7.62 ±0.015/0.381	0.360/9.15 ±0.018/0.457	0.400/10.2 ±0.020/0.508	0.550/14.0 ±0.028/0.711	0.650/16.5 ±0.033/0.838	0.750/19.1 ±0.038/0.965
Width W	0.250/6.35 ±0.015/0.381	0.400/10.2 ±0.020/0.508	0.400/10.2 ±0.020/0.508	0.400/10.2 ±0.020/0.508	0.500/12.7 ±0.025/0.635	0.600/15.2 ±0.030/0.762	0.650/16.5 ±0.033/0.838
End Band MB	0.030/0.762 ±0.015/0.381	0.030/0.762 ±0.015/0.381	0.030/0.762 ±0.015/0.381	0.040/1.02 ±0.020/0.508	0.040/1.02 ±0.020/0.508	0.040/1.02 ±0.020/0.508	0.040/1.02 ±0.020/0.508

CAPACITANCE AND VOLTAGE SELECTION- PULSE ENERGY (R)

Size	2225	3040	3640	4040	5550	6560	7565	
Tmax	*0.150 3.81	0.250 6.35	0.200 5.08	*0.250 6.35	0.300 7.62	0.300 7.62	0.300 7.62	0.300 7.62
1kV	633	204	204	224	254	394	724	
1.1kV	543	184	184	214	244	354	674	
1.2kV	483	174	174	204	224	334	624	
1.3kV	393	164	174	194	204	314	574	
1.4kV	373	154	164	194	204	294	544	
1.5kV	333	144	154	184	194	274	514	
1.6kV	273	124	124	154	174	254	464	
1.7kV	203	963	963	124	154	224	414	
1.8kV	173	793	793	104	134	204	374	
1.9kV	133	653	653	853	104	174	294	
2kV	113	563	563	723	913	144	224	
2.5kV	682	313	313	403	503	833	134	
3kV	202	113	113	143	173	283	513	

Notes:

1. Maximum capacitance values are shown above as 3 digit code: 2 significant figures followed by the no. of zeros e.g. 473 = 47,000pF
2. Capacitance values at 25°C, 1vrms and 1kHz. Additional case sizes and voltages available. Listed capacitance values and performance characteristics are for reference only.
3. *X140, X150 or X250 needs to be in the part number for special thickness order.

ORDERING INFORMATION - PULSE ENERGY (R)

RC/RG	3640	R	124	K	102	P	X---	T
STYLE RC = Bleed Resistor (optional)	SIZE See chart	DIELECTRIC R = R2D	CAPACITANCE Value in Picofarads. Two significant figures, followed by number of zeros: 124 = 120,000pF	TOLERANCE J = ± 5.0% K = ± 10% M = ± 20% Z = +80-20% P = +100-0%	VOLTAGE VDCW Two significant figures, followed by number of zeros: 102 = 1000V	TERMINATION K = Palladium Silver for Lead Free Solder P = Palladium Silver N = Nickel barrier 100% tin Y = Nickel barrier tin/lead	THICKNESS X140, X150 or X250 dependant on case size. See capacitance table.	PACKING T = Reeled
STYLE RG = Bleed Resistor with over glaze								



High Q Capacitors — Q and U Ranges

The “Q” and “U” ranges offer a very stable High Q material system that provides excellent low loss performance in systems below 3GHz. Optimized for lowest possible ESR, this range of high frequency capacitors is suitable for many applications where economical, high performance is required.

Available in 0603 to 3640 case sizes (0603 and 0805 case sizes only available in the “U” range) with various termination options, including FlexiCap™.

CapCad™ capacitor modeling software is now available and has been developed with an easy-to-use and readily accessible comparison tool for choosing the best MLCC to suit the customer’s needs. Please consult the Knowles website to launch the software.

OPERATING TEMPERATURE -55°C to +125°C

TEMPERATURE COEFFICIENT (TYPICAL)

0 ± 30 ppm/°C (COG/NPO)

INSULATION RESISTANCE

MS range: >100GΩ at +25°C; >10GΩ +125°C.

U range: 100GΩ or 1000s (whichever is the least)

Q FACTOR >2000 @ 1MHz

MINIMUM/MAXIMUM CAPACITANCE VALUES — Q AND U RANGES — HIGH Q CAPACITORS

Chip Size	0402	0603*		0505	0805*		1206	1111		1210	1812	2220	2225	4040	
Range	Q	Q	U	Q	Q	U	Q	Q	U	Q	Q	Q	Q	Q	
Min cap.	0.1pF	0.1pF	0.1pF	0.2pF	0.2pF	0.2pF	0.5pF	0.3pF	0.4pF	0.3pF	1.0pF	2.0pF	-	-	
50V/63V	-	200pF	-	330pF	680pF	-	2.2nF	-	-	-	-	-	-	-	
100V	-	150pF	-	220pF	470pF	-	1.5nF	3.3nF	2.2nF	3.3nF	6.8nF	15nF	-	-	
150V	-	120pF	-	220pF	390pF	-	1.2nF	2.7nF	1.5nF	2.7nF	4.7nF	12nF	-	-	
200V	33pF	100pF	100pF	150pF	330pF	240pF	1.0nF	2.2nF	1.0nF	2.2nF	3.9nF	10nF	-	-	
250V	33pF	100pF	100pF	150pF	330pF	240pF	1.0nF	2.2nF	1.0nF	2.2nF	3.9nF	10nF	6.2-10nF	16-27nF	
300V	-	56pF	-	100pF	220pF	-	680pF	1.5nF	680pF	1.5nF	3.3nF	6.8nF	-	-	
500V	-	-	-	-	100pF	-	330pF	820pF	560pF	820pF	2.2nF	4.7nF	5.1-5.6nF	13-15nF	
630V	-	-	-	-	-	-	150pF	390pF	470pF	390pF	1.0nF	2.2nF	3.6-4.7nF	11-12nF	
1000V	-	-	-	-	-	-	82pF	220pF	220pF	220pF	680pF	1.5nF	2.7 - 3.3nF	9.1-10nF	
1500V	-	-	-	-	-	-	-	-	100pF	-	-	-	1.1 - 2.4nF	5.6-8.2nF	
2000V	-	-	-	-	-	-	18pF	68pF	68pF	68pF	150pF	470pF	910pF-1.0nF	2.4-5.1nF	
3000V	-	-	-	-	-	-	-	-	-	-	68pF	150pF	110-470pF	910pF-1.5nF	
3600V	-	-	-	-	-	-	-	-	-	-	-	-	1.0-100pF	-	
4000V	-	-	-	-	-	-	-	-	-	-	-	-	-	620-820pF	
5000V	-	-	-	-	-	-	-	-	-	-	-	-	-	360-560pF	
6000V	-	-	-	-	-	-	-	-	-	-	-	-	-	160-330pF	
7,000/7200V	-	-	-	-	-	-	-	-	-	-	-	-	-	1.0-150pF	
Tape quantities	7" reel	10,000	4,000	4,000	2,500	3,000	3,000	2,500	1,000	1,000	2,000	500	500	500	-
	13" reel	15,000	16,000	16,000	10,000	12,000	12,000	10,000	5,000	5,000	8,000	2,000	2,000	2,000	500

DIMENSIONS

Range	Case Size	Length (L1) mm ~ inches	Width (W) mm ~ inches	Thickness (T)* mm ~ inches	Termination Band (L2)	
					Min	Max
U	0603	1.6 ± 0.20 ~ 0.063 ± 0.008	0.8 ± 0.2 ~ 0.032 ± 0.008	0.8 ~ 0.032	0.20 ~ 0.008	0.40 ~ 0.016
Q	0505	1.4 +0.35/-0.25 ~ 0.055 +0.014/-0.01	1.4 ± 0.25 ~ 0.055 ± 0.01	1.27 ~ 0.05	0.13 ~ 0.005	0.5 ~ 0.02
U	0805	2.0 ± 0.30 ~ 0.079 ± 0.012	1.25 ± 0.20 ~ 0.049 ± 0.008	1.3 ~ 0.051	0.25 ~ 0.010	0.75 ~ 0.03
Q	1206	3.2 +0.20/-0.30 ~ 0.126 +0.008/-0.012	1.6 ± 0.20 ~ 0.063 ± 0.008	1.7 ~ 0.068	0.25 ~ 0.010	0.75 ~ 0.03
Q	1111	2.79 +0.51/-0.25 ~ 0.11 +0.02/-0.01	2.79 ± 0.38 ~ 0.113 ± 0.015	1.78 ~ 0.07	0.13 ~ 0.005	0.63 ~ 0.025
U	1111	2.79 +0.51/-0.25 ~ 0.11 +0.02/-0.01	2.79 ± 0.38 ~ 0.113 ± 0.015	2.0 ± 0.2 ~ 0.08 ± 0.008	0.13 ~ 0.005	0.63 ~ 0.025
Q	1210	3.2 +0.20/-0.30 ~ 0.126 +0.008/-0.012	2.5 ± 0.30 ~ 0.098 ± 0.012	2.0 ~ 0.08	0.25 ~ 0.010	0.75 ~ 0.030
Q	1812	4.5 ± 0.35 ~ 0.18 ± 0.014	3.2 ± 0.3 ~ 0.126 ± 0.012	2.5 ~ 0.10	0.25 ~ 0.010	1.43 ~ 0.045
Q	2220	5.7 ± 0.40 ~ 0.225 ± 0.016	5.0 ± 0.40 ~ 0.197 ± 0.016	2.5 ~ 0.10	0.381 ~ 0.01	1.0 ~ 0.040
Q	2225	5.7 ± 0.40 ~ 0.225 ± 0.016	6.30 ± 0.40 ~ 0.252 ± 0.016	4.0 ~ 0.157	0.25 ~ 0.010	1.0 ~ 0.040
Q	4040	10.2 ± 0.508 ~ 0.400 ± 0.020	10.2 ± 0.508 ~ 0.400 ± 0.020	5.0 ~ 0.197	0.50 ~ 0.020	1.50 ~ 0.06

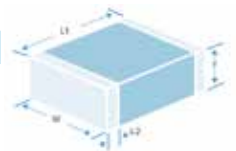

*All thicknesses are maximum dimensions unless otherwise stated.



High Q Capacitors — Q and U Ranges

Q Series — Impedance vs. Frequency — Case Size 0505

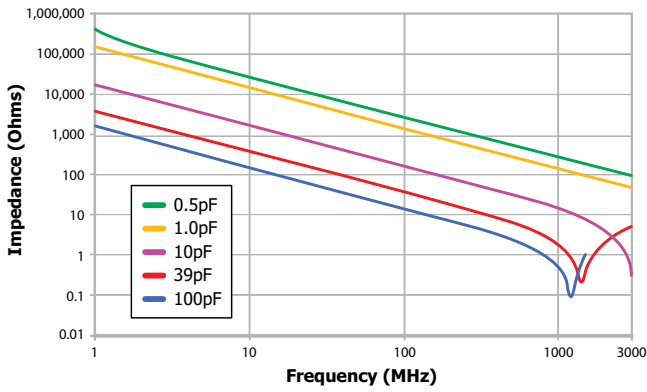

Q Series — Impedance vs. Frequency — Case Size 1111

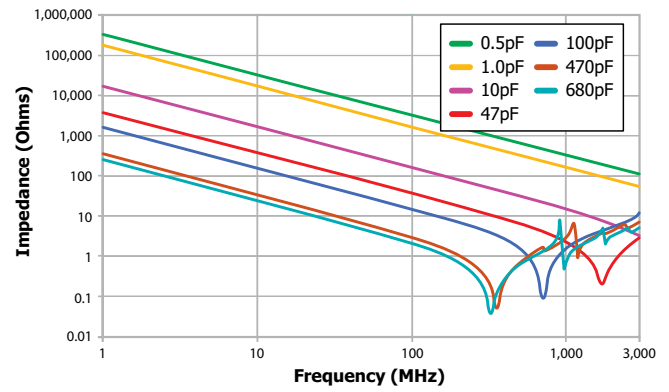

Q Series — ESR vs. Frequency — Case Size 0505

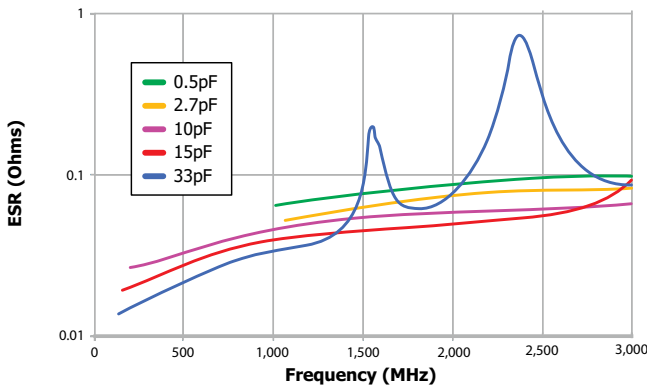

Q Series — ESR vs. Frequency — Case Size 1111

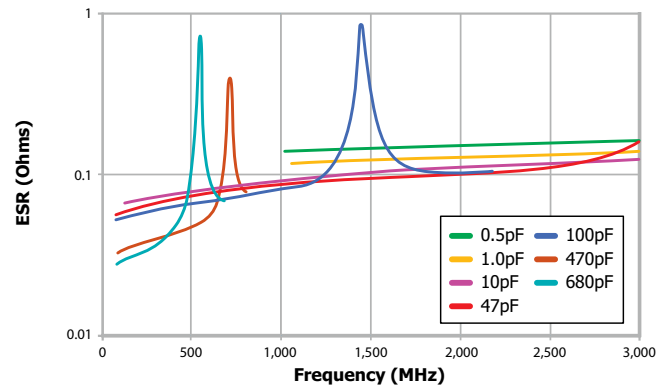

Q Series — Q vs. Frequency — Case Size 0505

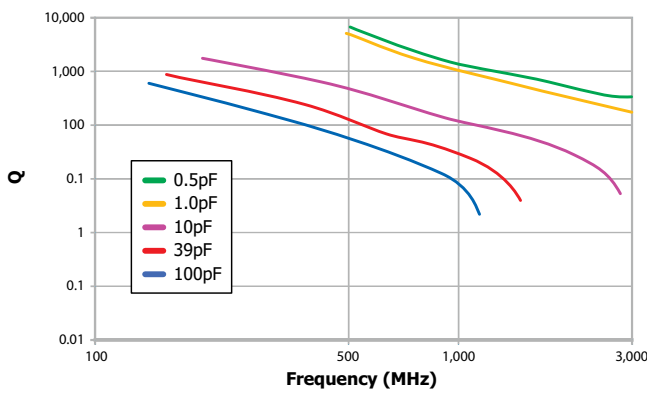

Q Series — Q vs. Frequency — Case Size 1111

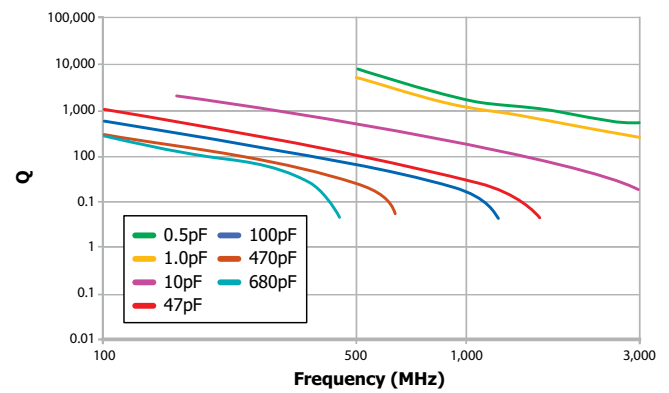

All performance curves are based on measurements taken with Boonton 34A resonant tube, Agilent E4991A impedance analyzer and Agilent 16197A test fixture. Different test methods or fixtures may give different results. Data is typical and is supplied for indication only.



High Q Capacitors — Q and U Ranges

U Series — Impedance vs. Frequency — Case Size 0603

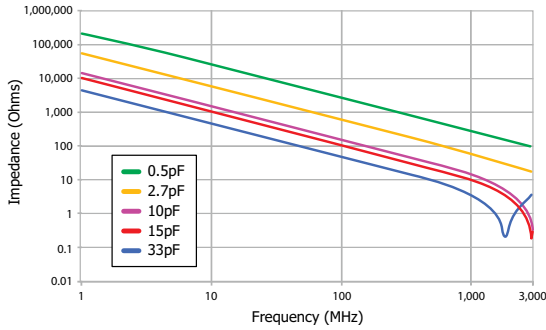

U Series — Impedance vs. Frequency — Case Size 0805

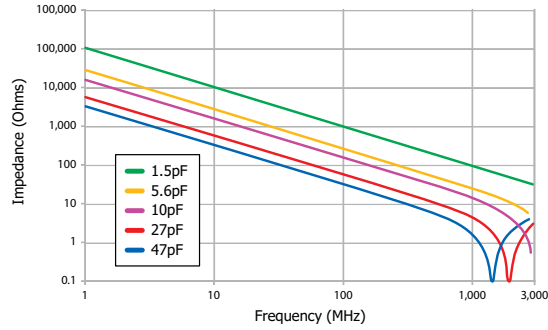

U Series — ESR vs. Frequency — Case Size 0603

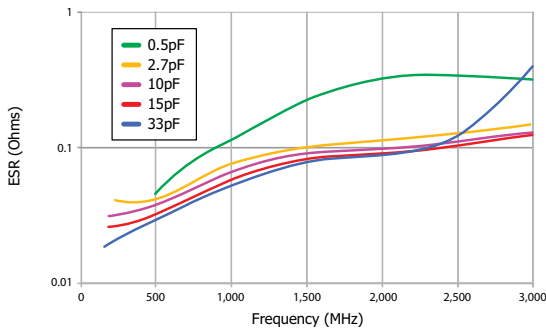

U Series — ESR vs. Frequency — Case Size 0805

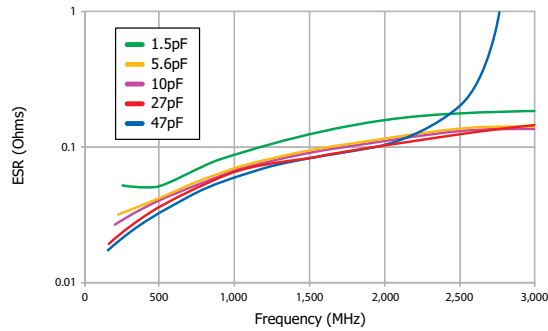

U Series — Q vs. Frequency — Case Size 0603

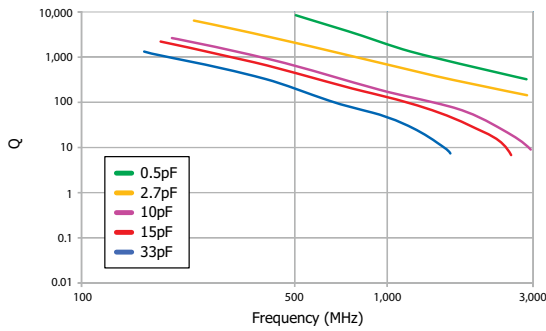

U Series — Q vs. Frequency — Case Size 0805

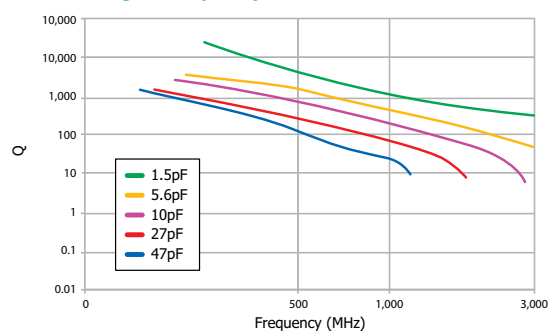

Note: All performance curves are based on measurements taken with Boonton 34A resonant tube, Agilent E4991A impedance analyzer and Agilent 16197A test fixture. Different test methods or fixtures may give different results. Data is typical and is supplied for indication only.

*0402 size and other values (inc. values < than 0.3pF) and taping quantities may be available on request, consult the Sales Office.
 †0603 and 0805 sizes only available in the "U" range and not Q.

DIMENSIONS

0805	J	250	4P70	B	U	T
Chip size	Termination	Voltage	Capacitance in picofarads (pF)	Capacitance tolerance	Dielectric	Packaging
0402* 0603† 0505 0805* 1206 1111 1210 1812 2220 2225 3640	J = Nickel barrier (100% matte tin plating). RoHS compliant. Lead free. A = Nickel barrier (Tin/lead plating with min. 10% lead). Not RoHS compliant.	050 = 50V 063 = 63V 100 = 100V 150 = 150V 200 = 200V 250 = 250V 300 = 300V 500 = 500V 630 = 630V 1K0 = 1kV 2K0 = 2kV 3K0 = 3kV 4K0 = 4kV 5K0 = 5kV 6K0 = 6kV 7K0 = 7kV 7K2 = 7.2kV	<1.0pF: Insert a P for the decimal point as the first character, e.g., P300 = 0.3pF Values in 0.1pF steps ≥1.0pF & <10pF: Insert a P for the decimal point as the second character, e.g., 8P20 = 8.2pF Values are E24 series ≥10pF: First digit is 0. Second and third digits are significant figures of capacitance code; fourth digit is number of zeros, e.g., 0101 = 100pF Values are E24 series	<4.7pF H = ±0.05pF B = ±0.1pF C = ±0.25pF D = ±0.5pF <10pF B = ±0.1pF C = ±0.25pF D = ±0.5pF ≥10pF F = ±1% G = ±2% J = ±5% K = ±10%	Q = High Q version of COG/NPO U = High Q version of COG/NPO	T = 178mm (7") reel R = 330mm (13") reel B = Bulk pack — tubs or trays



Ultra-Low ESR High Q MLCCs — X8G Range

The Ultra-Low ESR HiQ X8G range offers a very stable, High Q material system that provides excellent low loss performance. Optimized for lowest possible ESR, the electrode system provides low metal losses resulting in flatter performance curves and reduced losses at higher frequencies.

An extended operating temperature range of -55°C to +150°C accommodates modern high density microelectronics requirements. This range of high frequency capacitors is suitable for many applications where economical, high performance is required.



ULTRA-LOW ESR HIQ CAPACITORS — X8G RANGE — CAPACITANCE VALUES

Chip size	0402	0505	0603	0709	0805	1111
Thickness	0.6mm max	1.27mm max	0.8mm max	2.0 ± 0.2mm	1.0mm max	2.0 ± 0.2mm
Min cap	0.1pF	0.3pF	0.1pF	1.0pF	0.2pF	0.5pF
Min cap	0.2pF	0.3pF	0.2pF	-	0.2pF	-
50V	100pF	1.0nF	470pF	-	1.5nF	5.1nF
100V	100pF	560pF	470pF 150pF	-	1.0nF	5.1nF
200V	-	-	-	-	-	5.1nF
250V	33pF	270pF	150pF	-	820pF	5.1nF
500V	33pF	240pF	150pF	100pf	430pF	1.8nF
630V	-	-	-	-	-	1.8nF
1kV	-	-	-	-	47pF	1.8nF
1.5kV	-	-	-	-	-	820pF
2kV	-	-	-	-	-	390pF
Tape quantities	7" reel - 10,000 13" reel - 15,000	7" reel - 2,500 13" reel - 10,000	7" reel - 4,000 13" reel - 16,000	7" reel - 1,500 13" reel - 5,000	7" reel - 3,000 13" reel - 12,000	7" reel - 1,000 13" reel - 5,000

OPERATING TEMPERATURE:
-55°C to +150°C (EIA X8G)

TEMPERATURE COEFFICIENT (TYPICAL):
0 ± 30 ppm/°C (EIA X8G)

INSULATION RESISTANCE: Time constant (Ri xCr) (whichever is the least)
100GΩ or 1000s

Q FACTOR: >2000 @ 1MHz

Note: Blue background = AEC-Q200.
Capacitance values below 1pF are in 0.1pF steps. Capacitance values higher than 1pF follow E24 series.

ORDERING INFORMATION — ULTRA-LOW ESR HIQ CAPACITORS — X8G RANGE

085	J	250	0101	J	H	T
Chip Size	Termination	Voltage	Capacitance in Picofarads (pF)	Capacitance Tolerance	Dielectric	Packaging
0402 0505 0603 0709 0805 1111	J = Nickel barrier (100% matte tin plating). RoHS compliant. Lead free. A = Nickel barrier Tin/lead plating with min. 10% lead). Not RoHS compliant 6 = Nickel Barrier, Sn/Pb Plated Solder (5-20% Lead, non RoHS)	050 = 50V 100 = 100V 200 = 200V 250 = 250V 500 = 500V 630 = 630V 1K0 = 1kV 1K5 = 1.5kV 2K0 = 2.0kV 3K0 = 3.0kV	<1.0pF: Insert a P for the decimal point as the first character. e.g., P300 = 0.3pF Values in 0.1pF steps ≥1.0pF & <10pF: Insert a P for the decimal point as the second character. e.g., 8P20 = 8.2pF Values are E24 series ≥10pF: First digit is 0. Second and third digits are significant figures of capacitance code. Fourth digit is number of zeros. e.g., 0101 = 100pF Values are E24 series	<4.7pF H = ±0.05pF B = ±0.1pF C = ±0.25pF D = ±0.5pF <10pF B = ±0.1pF C = ±0.25pF D = ±0.5pF ≥10pF F = ±1% G = ±2% J = ±5% K = ±10%	V = Ultra-Low ESR High Frequency X8G to AEC-Q200 H = Ultra-Low ESR High Frequency X8G	T = 178mm (7") horizontal reel R = 330mm (13") reel B = Bulk pack — tubs or trays V = 178mm (7") vertical reel*

* Vertical reel is available for case size 1111 only



Ultra-Low ESR High Q MLCCs — X8G Range

TYPICAL PERFORMANCE — 0603 CHIP SIZE

0603 H SERIES IMPEDANCE vs. FREQUENCY

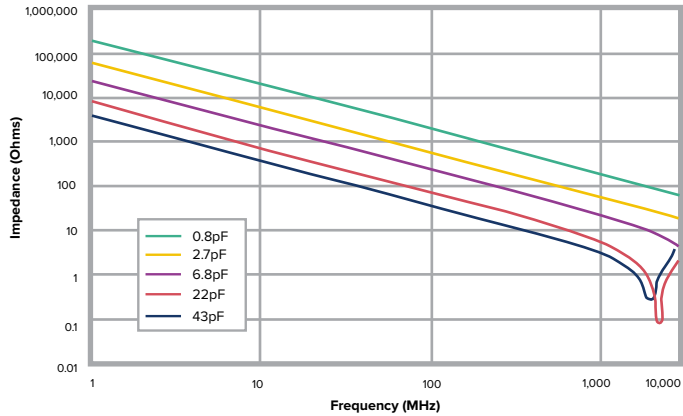

TYPICAL PERFORMANCE — 0805 CHIP SIZE

0805 H SERIES IMPEDANCE vs. FREQUENCY

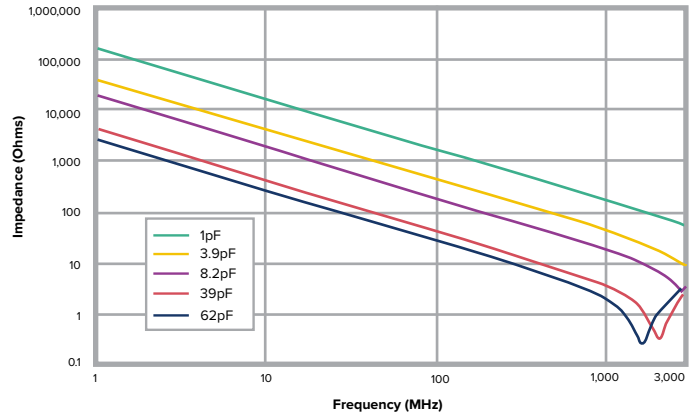

0603 H SERIES ESR vs. FREQUENCY

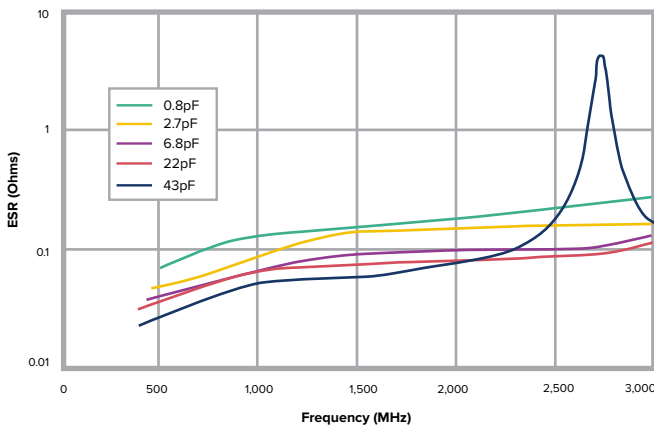

0805 H SERIES ESR vs. FREQUENCY

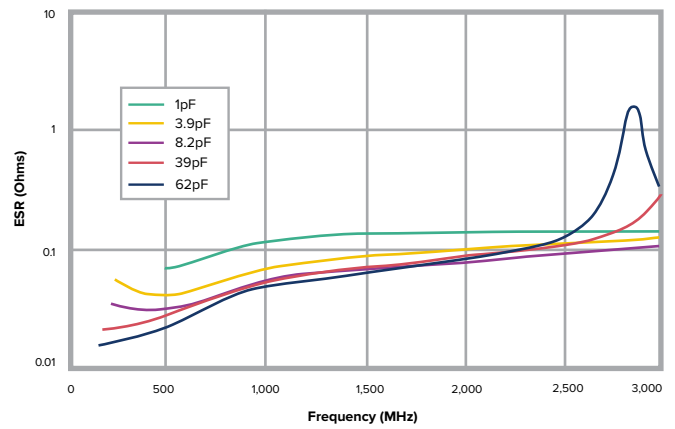

0603 H SERIES Q vs. FREQUENCY

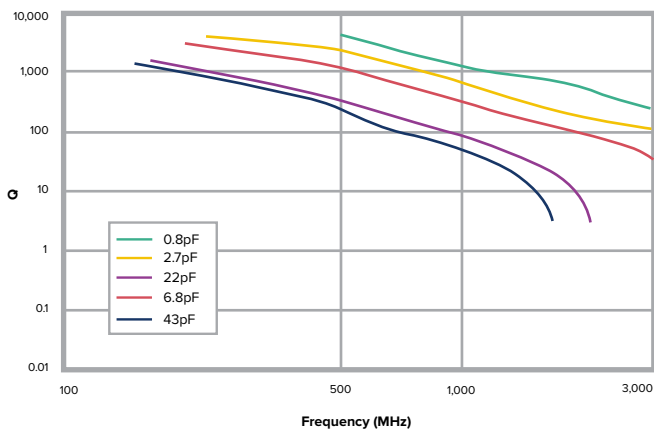

0805 H SERIES Q vs. FREQUENCY

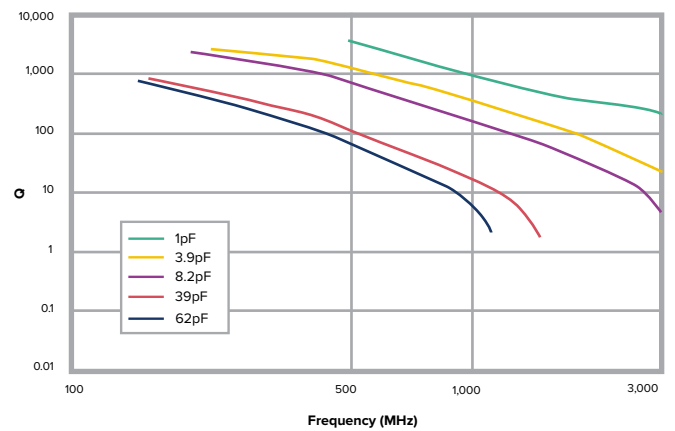

High Q Porcelain Capacitors — CF Series

DESCRIPTION

- High Q Porcelain Capacitors
- SMD Compatibility
- Ultra Temperature Stable
- Low ESR, High Q
- Capacitance Range 0.1-5100 pF
- Operating Range -55° to +125°C
- High Voltage
- High Self-Resonance
- Low Noise
- Established Reliability

FUNCTIONAL APPLICATIONS

- Impedance Matching
- Power Handling
- DC Blocking
- Bypass
- Coupling
- Tuning and Feedback
- Amplifier Matching Networks
- VCO Frequency Stabilization
- Filtering, Diplexers and Antenna Matching
- High RF Power Circuits
- Oscillators
- Timing Circuits
- Filters
- RF Power Amplifiers and Delay Lines

DIELECTRIC CHARACTERISTICS

Dielectric Material (Code)		COG/NP0 (CF)
Temperature Coefficient (ppm/°C)		0 ± 15
Dissipation Factor (% @ 1MHz Maximum)		0.05
Dielectric Withstanding Voltage	Voltage Rating (Volts)	Refer to table
	DWV (Volts)	250% of rated
Insulation Resistance (MΩ Minimum)	@ +25°C	10 ⁶ MΩ min
	@ +125°C	10 ⁵ MΩ min
Aging		None
Piezoelectric Effects		None
Dielectric Absorption		None

CAPACITANCE AND VOLTAGE TABLE

Cap Code	Cap (PF)	Case Size					
		C06 0603	C11 0505	C17 1111	C18 1111	C22 2225	C40 3838
0R1	0.1						
0R2	0.2						
0R3	0.3						
0R4	0.4						
0R5	0.5						
0R6	0.6						
0R7	0.7						
0R8	0.8						
0R9	0.9						
1R0	1.0						
1R1	1.1						
1R3	1.3						
1R4	1.4						
1R5	1.5						
1R6	1.6						
1R7	1.7						
1R8	1.8						
1R9	1.9						
2R0	2.0						
2R1	2.1						
2R2	2.2						
2R4	2.4						
2R7	2.7						
3R0	3.0						
3R3	3.3						
3R6	3.6						
3R9	3.9						
4R3	4.3						
4R7	4.7						
5R1	5.1						
5R6	5.6						
6R2	6.2						
6R8	6.8						
7R5	7.5						
8R2	8.2						
9R1	9.1						
100	10						
110	11						
120	12						
130	13						
150	15						
160	16						
180	18						
200	20						
220	22						
240	24						
270	27						
300	30						
330	33						
360	36						
390	39						
430	43						
470	47						
510	51						
560	56						
620	62						
680	68						
750	75						
820	82						
910	91						
101	100						
111	110						
121	120						
131	130						
151	150						
161	160						
181	180						
201	200						
221	220						
241	240						
271	270						
301	300						
331	330						
361	360						
391	390						
431	430						
471	470						
511	510						
561	560						
621	620						
681	680						
751	750						
821	820						
911	910						
102	1000						
122	1200						
152	1500						
182	1800						
222	2200						
272	2700						
332	3300						
392	3900						
472	4700						
512	5100						
Reel QTY		4000	3500	2350	2350	500	250

Special capacitance values available upon request.

High Q Porcelain Capacitors — CF Series

ESR vs. Frequency
DLI C06 CF Series

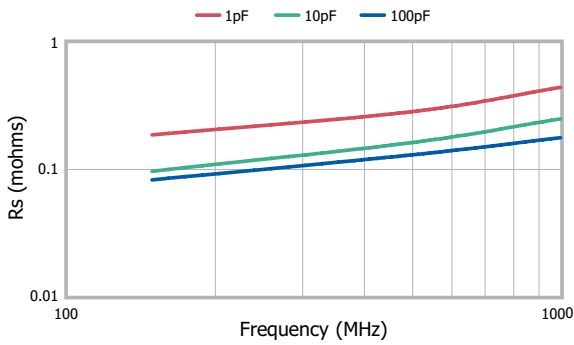

Q vs. Capacitance
DLI C06 CF Series

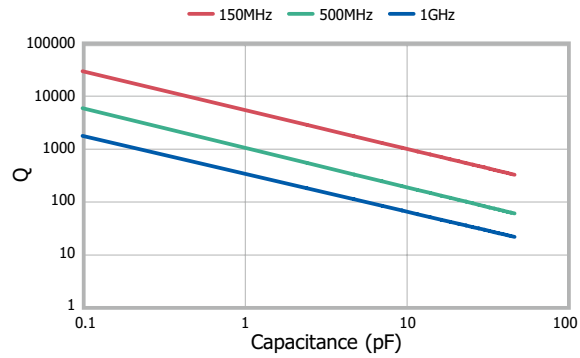

ESR vs. Frequency
DLI C11 CF Series

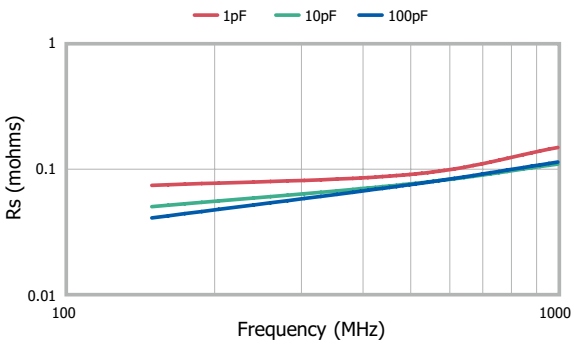

Q vs. Capacitance
DLI C11 CF Series

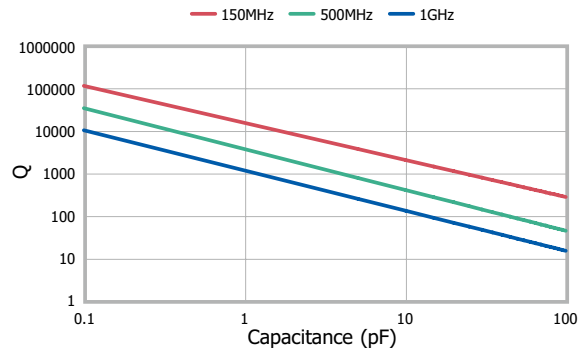

ESR vs. Frequency
DLI C17 CF Series

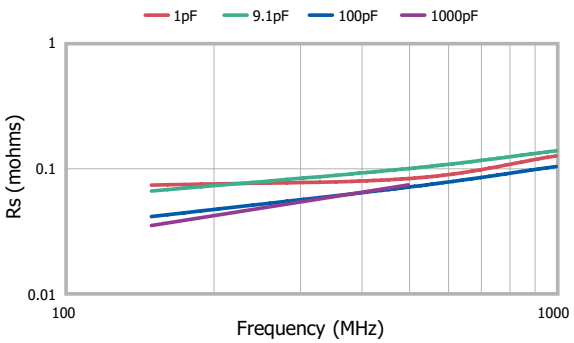

Q vs. Capacitance
DLI C17 CF Series

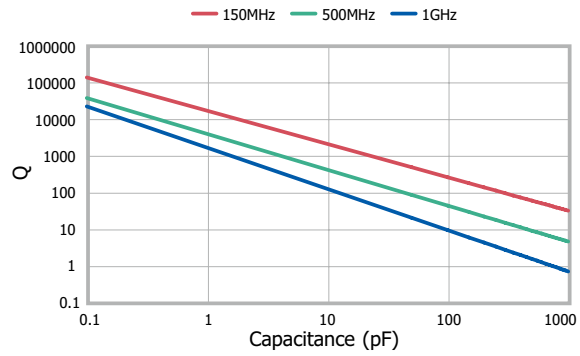

ESR vs. Frequency
DLI C18 CF Series

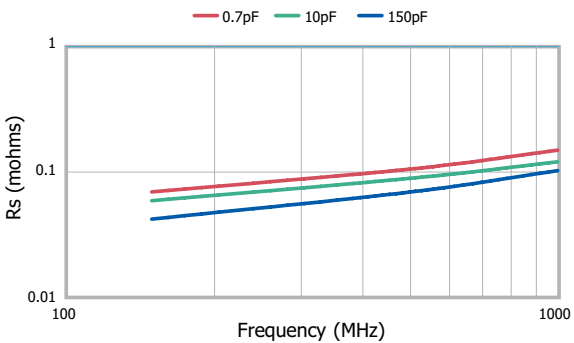

Q vs. Capacitance
DLI C18 CF Series

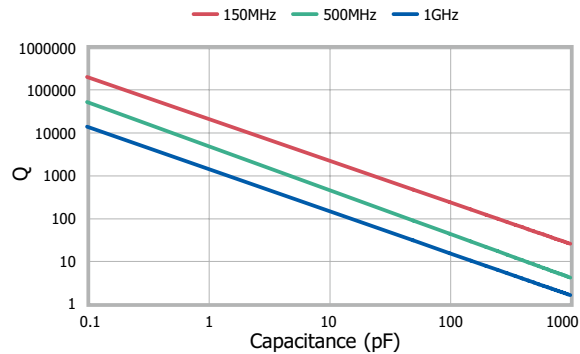

Note: This information represents typical device performance.



High Q Porcelain Capacitors — CF Series

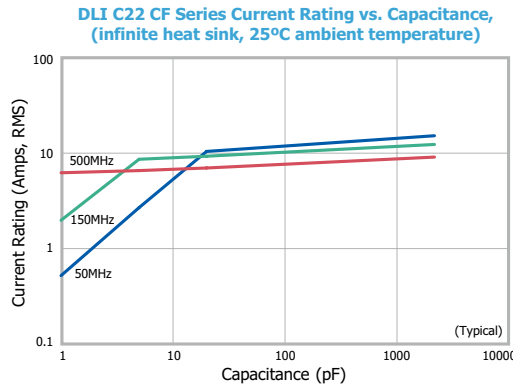
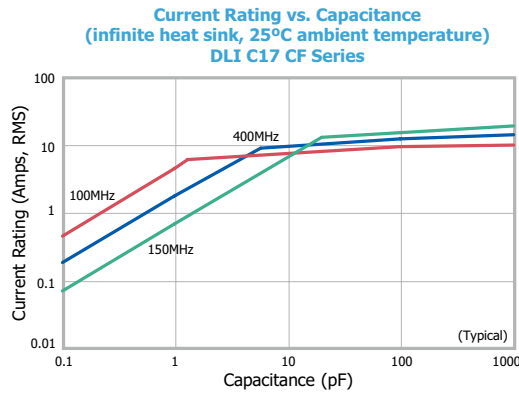
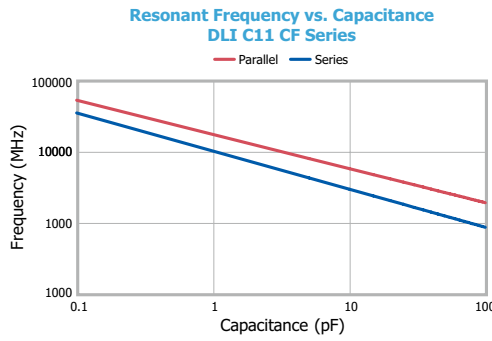
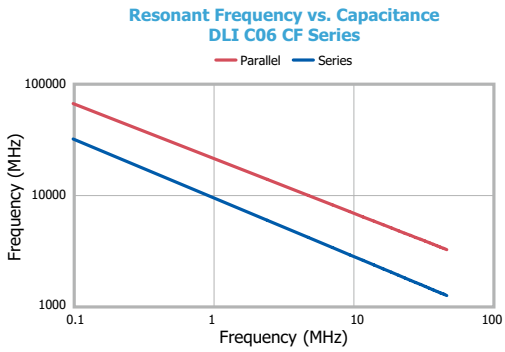
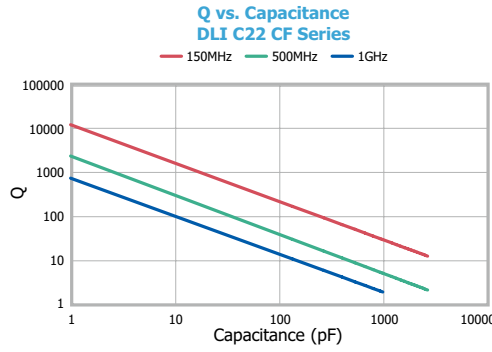
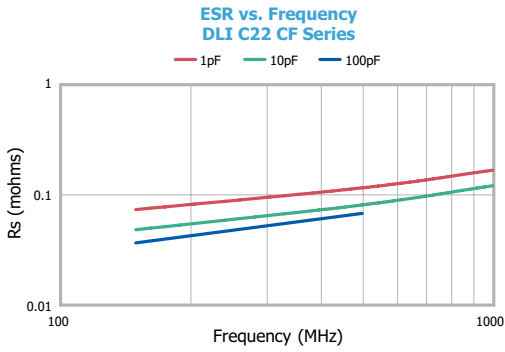

Note: This information represents typical device performance.

ORDERING INFORMATION — CF SERIES — See page 24 for complete part number system.

Chip size	Dielectric	Capacitance Code (pF)	Capacitance tolerance	Voltage Code	Termination	Lead Type	Test Level	Marking	Packaging
C06 C11 C17 C18 C22 C40	CF = COG/ NPO High Q	1 st two digits are significant figures of capacitance, 3 rd digit denotes number of zeros, R = decimal point. Examples: 1R0 = 1.0pF 471 = 471pF	<10pF A = ±0.05pF B = ±0.1pF C = ±0.25pF D = ±0.5pF ≥10pF F = ±1% G = ±2% J = ±5% K = ±10% M = ±20% X = GMV S = Special	5 = 50V 1 = 100V 6 = 200V 9 = 250V 4 = 500V 7 = 1kV A = 1.5kV G = 2kV B = 2.5kV D = 3.6kV H = 7.2kV	C06 U, S, Z, E, P, Q, Y, W, H, V, R C11/17 T, U, S, Z, E, P, Q, Y, W, H, V, R C18 U, Q, Y, V, W, H, Z C22 U, S, Z, E, P, Q, Y, W, H, V, R C40 T, U, S, P, Q, Y, W, H, V, R	A = Axial ribbon B = Radial ribbon C = Center ribbon D = Special E = Axial wire F = Radial wire N = Chip Note: C06 only available as N (Chip)	X = Standard Y = Reduced Visual A = MIL-PRF-55681 Group A C = MIL-PRF-55681 Group C D = Customer Specified	C06 0, 1, 2, 5 C11 0 C17 0, 1, 2, 5 C18/22/40 0, 1	C06 T, W, B, S C11/17/18 T, V, W, B, P, S C22 T, B, P, S C40 T, B, P, S, R

High Q Porcelain Capacitors — AH Series

DESCRIPTION

- High Q Porcelain Capacitors
- SMD Compatibility
- Positive TC “P90”
- Low ESR, High Q
- Capacitance Range 0.1-5100 pF
- Operating Range -55° to +125°C
- High Voltage
- High Self-Resonance
- Low Noise
- Established Reliability

FUNCTIONAL APPLICATIONS

- Impedance Matching
- Power Handling
- DC Blocking
- Bypass
- Coupling
- Tuning and Feedback
- Amplifier Matching Networks
- VCO Frequency Stabilization
- Filtering, Diplexers and Antenna Matching
- High RF Power Circuits
- Oscillators
- Timing Circuits
- Filters
- RF Power Amplifiers and Delay Lines

DIELECTRIC CHARACTERISTICS

Dielectric Material (Code)		P90 (AH)
Temperature Coefficient (ppm/°C)		+90 ± 20
Dissipation Factor (% @ 1MHz Maximum)		0.05
Dielectric Withstanding Voltage	Voltage Rating (Volts)	Refer to table
	DWV (Volts)	250% of rated
Insulation Resistance (MΩ Minimum)	@ +25°C	10 ⁶ MΩ min
	@ +125°C	10 ⁵ MΩ min
Aging		None
Piezoelectric Effects		None
Dielectric Absorption		None

CAPACITANCE AND VOLTAGE TABLE

Cap Code	Cap (PF)	C11 0505	C17 1111	Case Size		C40 3838
				C18 1111	C22 2225	
0R1	0.1	280V Code 9	4kV Code 7	2kV Code 6	2.8kV Code B	7.2kV Code H
0R2	0.2					
0R3	0.3					
0R4	0.4					
0R5	0.5					
0R6	0.6					
0R7	0.7					
0R8	0.8					
0R9	0.9					
1R0	1.0					
1R1	1.1					
1R3	1.3					
1R4	1.4					
1R5	1.5					
1R6	1.6					
1R7	1.7					
1R8	1.8					
1R9	1.9					
2R0	2.0					
2R1	2.1					
2R2	2.2					
2R4	2.4					
2R7	2.7					
3R0	3.0					
3R3	3.3					
3R6	3.6					
3R9	3.9					
4R3	4.3					
4R7	4.7					
5R1	5.1					
5R6	5.6					
6R2	6.2					
6R8	6.8					
7R5	7.5					
8R2	8.2					
9R1	9.1					
100	10					
110	11					
120	12					
130	13					
150	15					
160	16					
180	18					
200	20					
220	22					
240	24					
270	27					
300	30					
330	33					
360	36					
390	39					
430	43					
470	47					
510	51					
560	56					
620	62					
680	68					
750	75					
820	82					
910	91					
101	100					
111	110					
121	120					
131	130					
151	150					
161	160					
181	180					
201	200					
221	220					
241	240					
271	270					
301	300					
331	330					
361	360					
391	390					
431	430					
471	470					
511	510					
561	560					
621	620					
681	680					
751	750					
821	820					
911	910					
102	1000					
122	1200					
152	1500					
182	1800					
222	2200					
272	2700					
332	3300					
392	3900					
472	4700					
512	5100					
Reel QTY Horizontal		3500	2350	2350	500	250

Special capacitance values available upon request.



High Q Porcelain Capacitors — AH Series

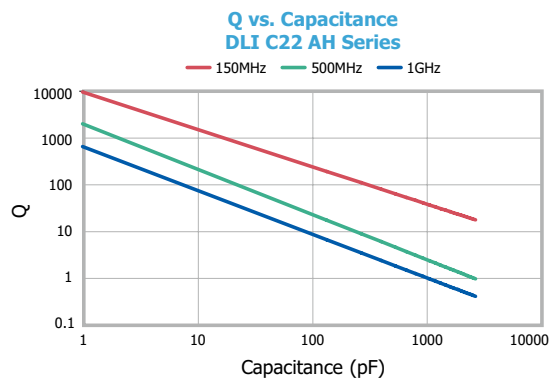
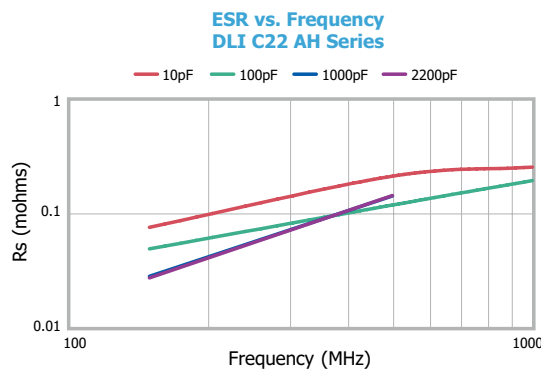
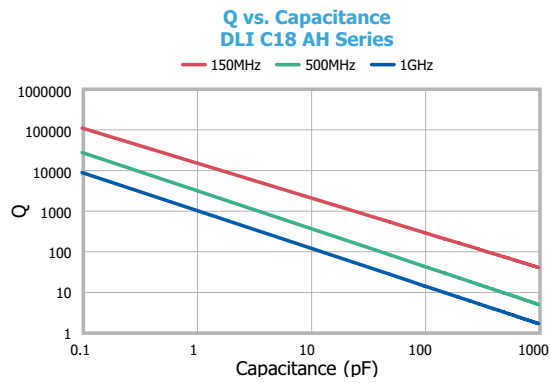
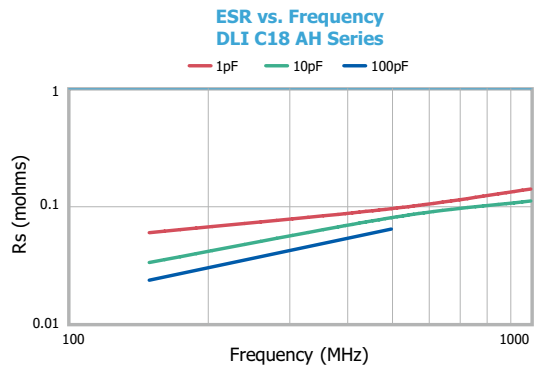
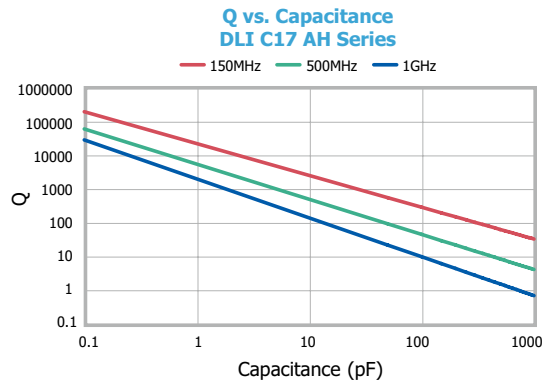
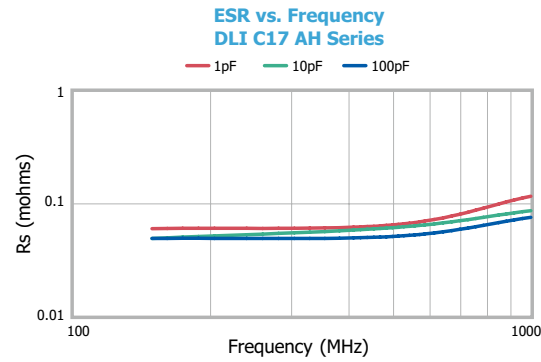
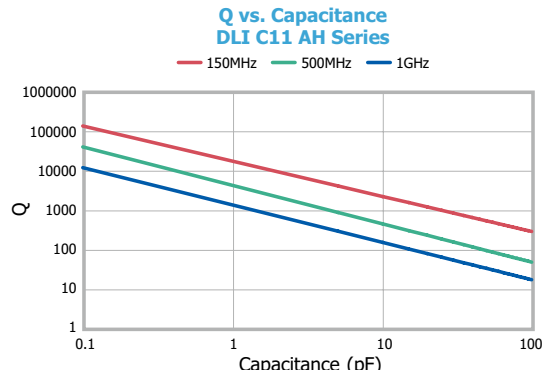
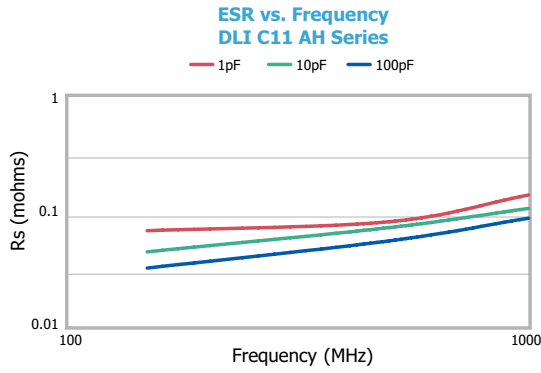

Note: This information represents typical device performance.



High Q Porcelain Capacitors — AH Series

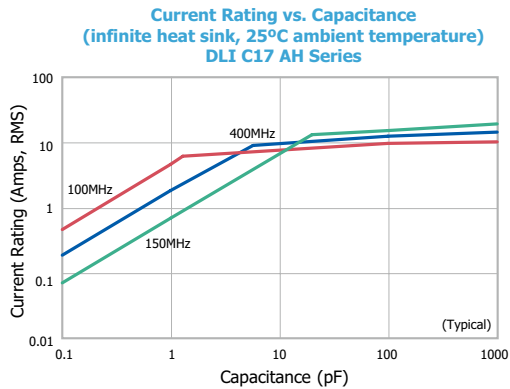
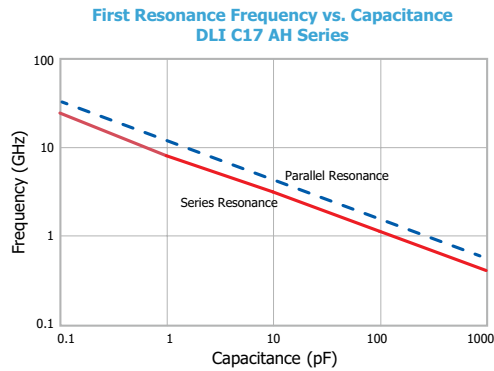
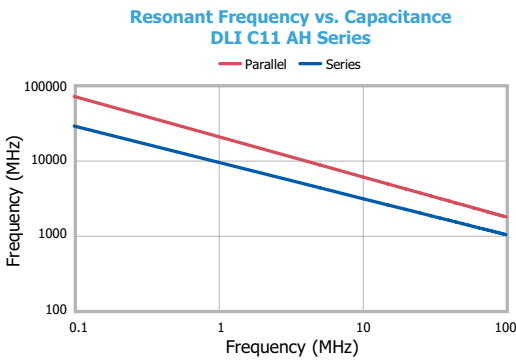
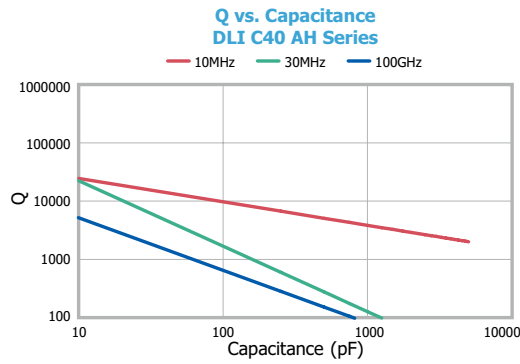
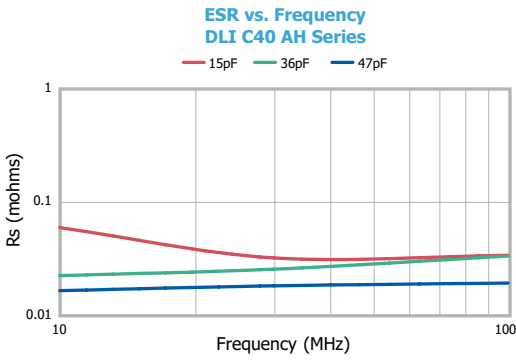

Note: This information represents typical device performance.

ORDERING INFORMATION — AH SERIES — See page 24 for complete part number system.

C17	AH	620	J	-	7	U	A	-	X	0	T
Chip size	Dielectric	Capacitance Code (pF)	Capacitance tolerance	Voltage Code	Termination	Lead Type	Test Level	Marking	Packaging		
C11 C17 C18 C22 C40	AH = P90 High Q	1 st two digits are significant figures of capacitance, 3 rd digit denotes number of zeros, R = decimal point. Examples: 1R0 = 1.0pF 471 = 471pF	<10pF A = ±0.05pF B = ±0.1pF C = ±0.25pF D = ±0.5pF ≥10pF F = ±1% G = ±2% J = ±5% K = ±10% M = ±20% X = GMV S = Special	5 = 50V 1 = 100V 6 = 200V 9 = 250V 4 = 500V 7 = 1kV A = 1.5kV G = 2kV B = 2.5kV D = 3.6kV H = 7.2kV	C11/17 T, U, S, Z, E, P, Q, Y, M, W, H, V, R C18 U, Z, E, Y, W, H C22 U, S, Z, E, P, Q, Y, M, W, H, V, R C40 T, U, S, Z, E, P, Q, Y, M, W, H, V, R	A = Axial ribbon B = Radial ribbon C = Center ribbon D = Special E = Axial wire F = Radial wire N = Chip Note: C11 only available with A, B, D or N options	X = Standard Y = Reduced Visual A = MIL-PRF-55681 Group A C = MIL-PRF-55681 Group C D = Customer Specified	C11 0, 1, 2, 5 C17 0, 1, 2, 3, 4, 5 C18 0, 1, 2, 5 C22/40 0, 1	C11/17/18 T, V, W, B, P, S C22 T, B, P, S C40 T, B, P, S, R		



UL Series — Ultra Low ESR Ceramic Capacitors

DESCRIPTION

- Ceramic Capacitors
- SMD Compatibility
- Stable TC NP0
- Low ESR, High Q
- Capacitance Range 0.2 - 2200 pF
- Operating Range -55° to +125°C
- High Voltage
- Low Noise
- EIA 0603 & 0805 Case Size

FUNCTIONAL APPLICATIONS

- DC Blocking
- Bypass
- Coupling
- Tuning & Feedback
- Amplifier Matching Networks
- VCO Frequency Stabilization
- Filtering, Dplexers & Antenna Matching
- High RF Power Circuits
- Oscillators
- Timing Circuits
- Filters
- Broadcast Power Amps
- RF Power Amplifiers & Delay Lines

DIELECTRIC CHARACTERISTICS

Dielectric Material (Code)		UL
Temperature Coefficient (ppm/°C)		0 ± 30
Dissipation Factor (% @ 1MHz Maximum)		0.05*
Dielectric Withstanding Voltage	Voltage Rating (Volts)	Refer to table
	DWV (Volts)	250% of rated
Insulation Resistance (MΩ Minimum)	@ +25°C	**
	@ +125°C	**
Aging		None
Piezoelectric Effect		None
Dielectric Absorption		None

* Does not apply <2 pF

** Refer to table and statement provided

CAPACITANCE AND VOLTAGE TABLE

Cap Code	Cap (pF)	Case Size					
		C04 0402	C06 0603	C07 0711	C08 0805	C11 0505	C17 1111
OR1	0.1						
OR2	0.2						
OR3	0.3						
OR4	0.4						
OR5	0.5						
OR6	0.6						
OR7	0.7						
OR8	0.8						
OR9	0.9						
1R0	1.0						
1R1	1.1						
1R3	1.3						
1R4	1.4						
1R5	1.5						
1R6	1.6						
1R7	1.7						
1R8	1.8						
1R9	1.9						
2R0	2.0						
2R1	2.1						
2R2	2.2						
2R4	2.4						
2R7	2.7						
3R0	3.0						
3R3	3.3						
3R6	3.6						
3R9	3.9						
4R3	4.3						
4R7	4.7						
5R1	5.1						
5R6	5.6						
6R2	6.2						
6R8	6.8						
7R5	7.5						
8R2	8.2						
9R1	9.1						
100	10						
110	11						
120	12						
130	13						
150	15						
160	16						
180	18						
200	20						
220	22						
240	24						
270	27						
300	30						
330	33						
360	36						
390	39						
430	43						
470	47						
510	51						
560	56						
620	62						
680	68						
750	75						
820	82						
910	91						
101	100						
111	110						
121	120						
151	150						
181	180						
221	220						
271	270						
331	330						
391	390						
471	470						
511	510						
561	560						
621	620						
681	680						
821	820						
911	910						
102	1000						
Reel QTY		5000	4000	2350	5000	3500	2350
Horizontal							

Special capacitance values available upon request.



UL Series — Ultra Low ESR Ceramic Capacitors

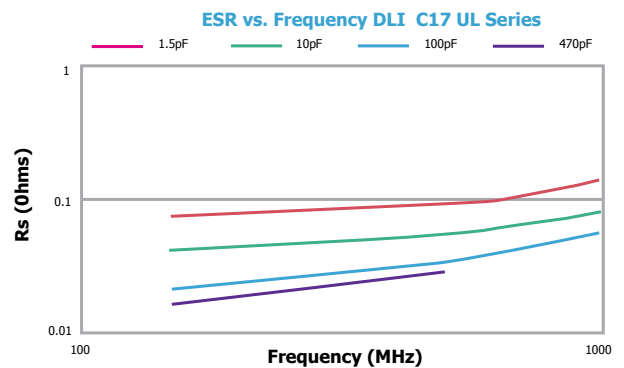
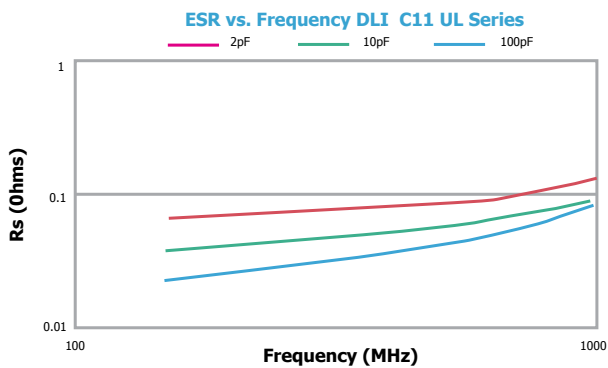
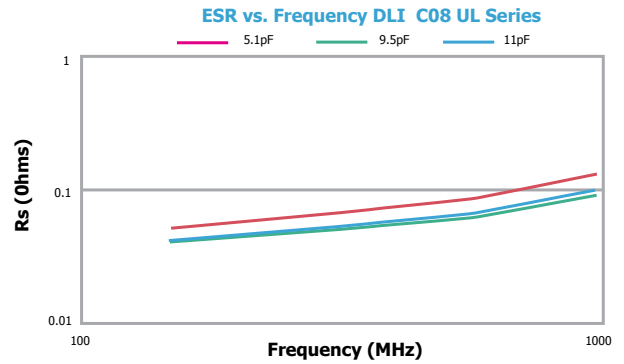
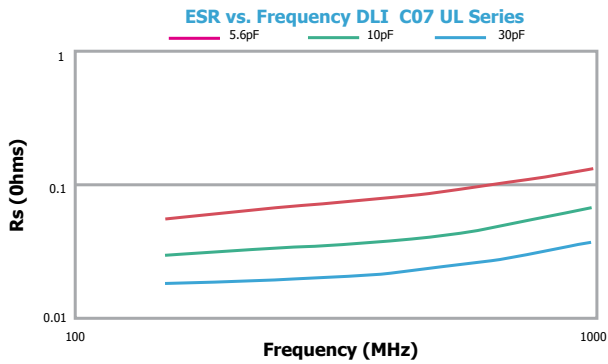
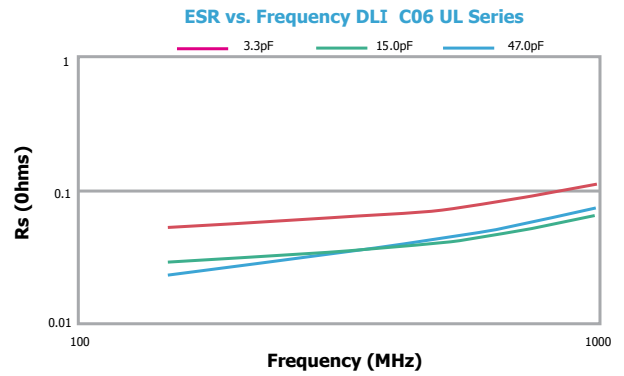
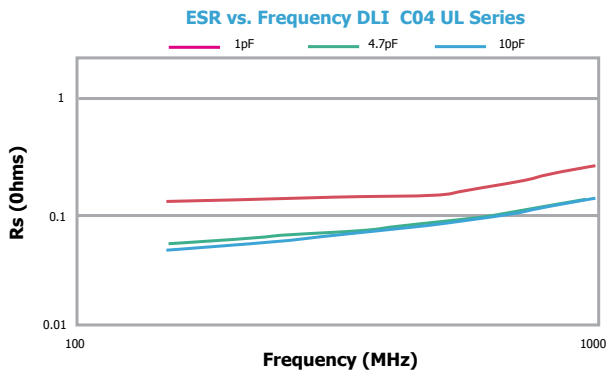

Note: This information represents typical device performance.



UL Series — Ultra Low ESR Ceramic Capacitors

Q vs. Capacitance DLI C04 UL Series

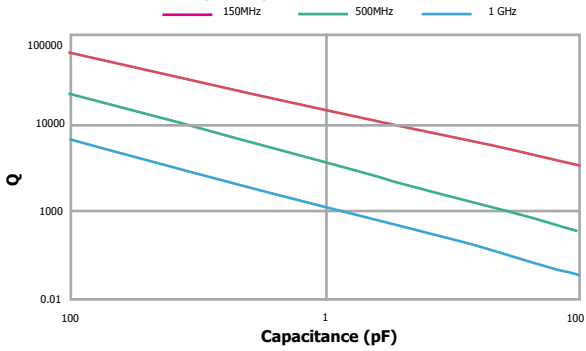

Q vs. Capacitance DLI C06 UL Series

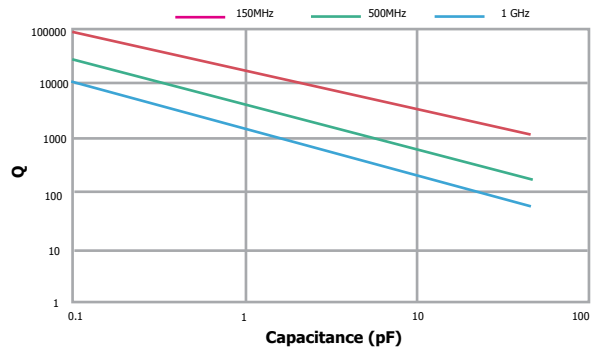

Q vs. Capacitance DLI C07 UL Series

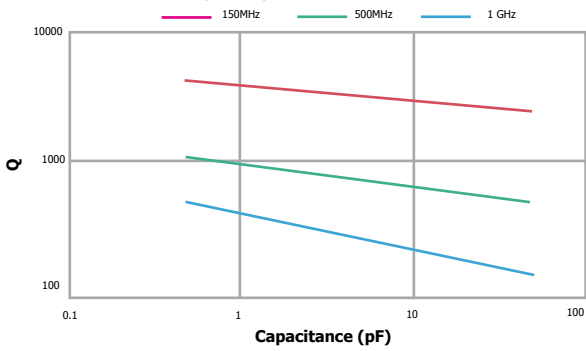

Q vs. Capacitance DLI C08 UL Series

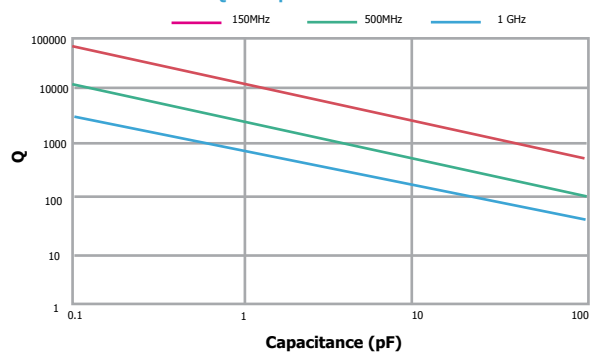

Q vs. Capacitance DLI C11 UL Series

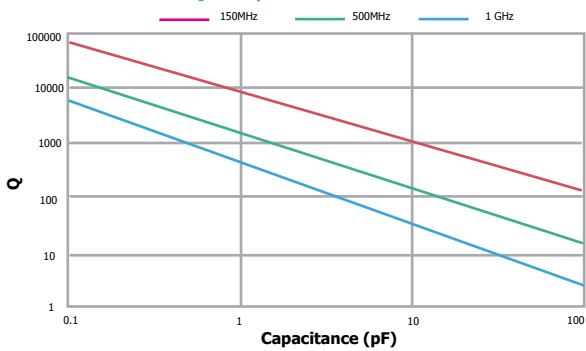

Q vs. Capacitance DLI C17 UL Series

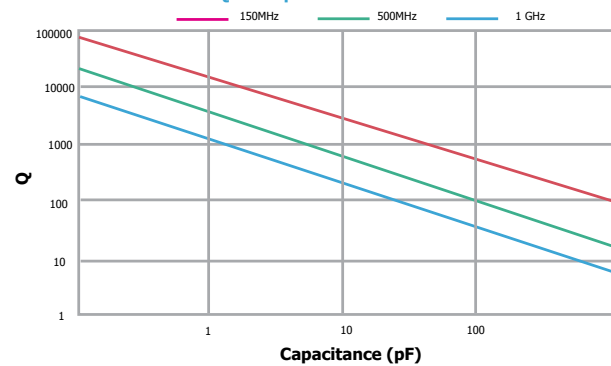

Note: This information represents typical device performance.



UL Series — Ultra Low ESR Ceramic Capacitors

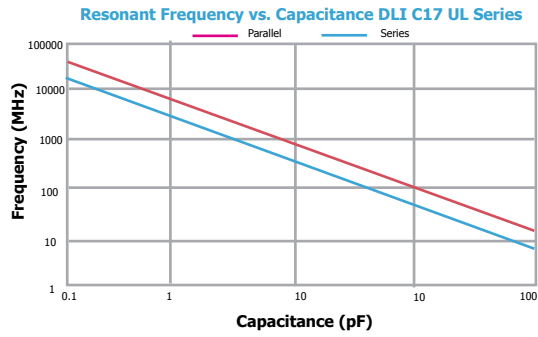
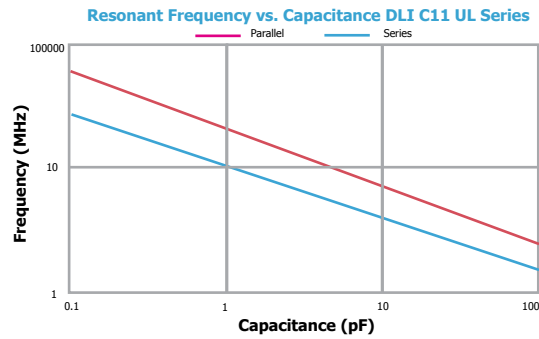
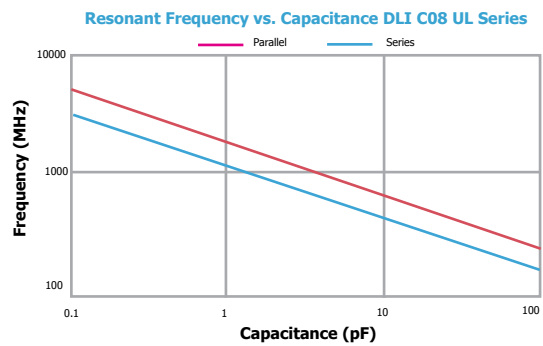
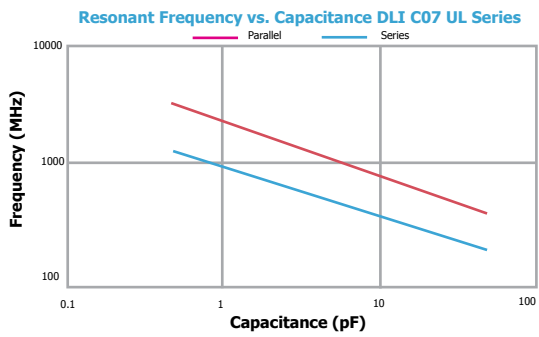
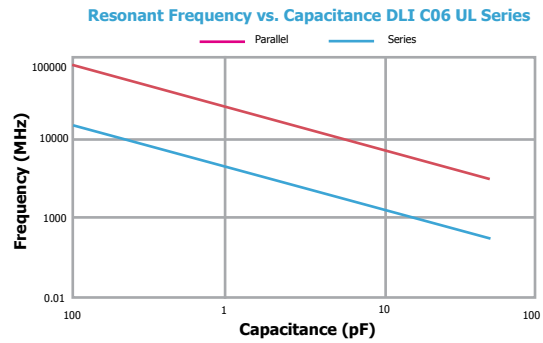
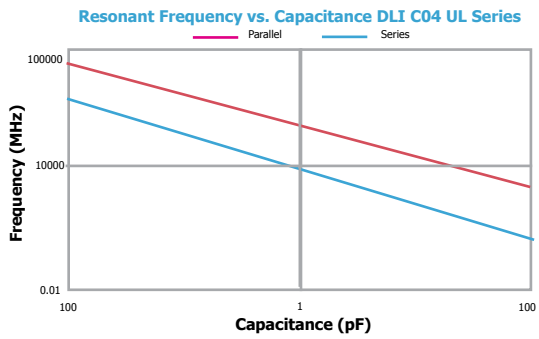

PART NUMBER — See page 24 for complete part number system.

C	17	UL	620	J - 7	U	N	X	- 0	T	
MLC Capacitor	Case Size	Material System	Capacitance Code	Tolerance Level	Voltage Code	Termination Code	Leading Code	Test Level	Marking Code	Packaging
Terminations		Lead Types		Test Level - All Case Sizes		Laser Marking		Packaging		
C04	S	C04/6/7/8	N	X	Standard	C04	0	C04/6	T, W, B, P, S	
C06	U, S, Z	C11	A, B, D	Y	Reduced Visual	C06	0, 1, 2	C07	W, B, P, S	
C07	S, Z	C17	A, B, C, D, E, F	A	MIL-PRF-55681 Group A	C07	0, 1	C08/11/17	T, V, W, B, P, S	
C08/11/17	U, S, Z	*Special leading requirements available.			C	MIL-PRF-55681 Group C	C08/11/17	0, 1, 2		
					D	Customer Specified				



VC1 Residual Capacitors — X7R

The VC1 residual capacitance range MLCCs provide a more stable capacitance value with voltage — not to drop below 50% of the 1Vrms 1kHz value, up to full rated DC voltage, at room temperature.

They can be operated continuously at full rated voltage, but if de-rated will maintain a larger percentage of their original capacitance value, e.g., at 80% RV capacitance value equals approximately 60% - see graph.

Operating Temperature

-55°C to +125°C

Temperature Coefficient (Typical)

± 15%

Insulation Resistance at +25°C

Time constant (Ri xCr) (whichever is the least) 100GΩ or 1000s

Aging Rate

Typical 1% per time decade

Defined capacitance value in case sizes from 0805 to 3640, with voltage rating up to 3kV. Ideal for power supplies, capacitance critical circuits, smoothing circuits and EMI suppression.

Typical Performance Curves

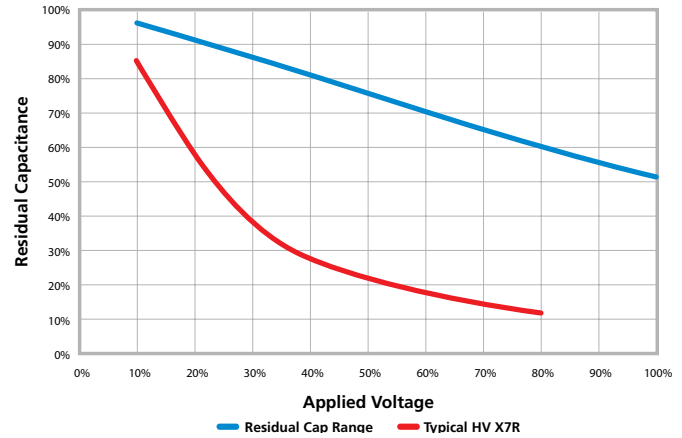

MINIMUM/MAXIMUM CAPACITANCE VALUES — VC1 CAPACITORS

Chip Size	0805	1206	1210	1808	1812	2220	2225	3640
Min Cap	100pF	150pF	220pF	220pF	470pF	1nF	1nF	2.2nF
250V	12nF	39nF	82nF	82nF	220nF	680nF	1µF	1.8µF
500V	2.2nF	6.8nF	15nF	15nF	56nF	150nF	220nF	560nF
630V	1.5nF	4.7nF	8.2nF	8.2nF	39nF	100nF	120nF	470nF
1000V	390pF	1.5nF	2.7nF	2.7nF	15nF	39nF	56nF	180nF
1200V	-	1nF	2.2nF	2.2nF	10nF	27nF	39nF	120nF
1500V	-	560pF	1.2nF	1.2nF	5.6nF	15nF	22nF	68nF
2000V	-	270pF	560pF	560pF	3.3nF	10nF	12nF	39nF
2500V	-	-	-	-	1.8nF	5.6nF	8.2nF	22nF
3000V	-	-	-	-	-	3.9nF	5.6nF	12nF
7" reel qty	3,000	2,500	2,000	500	500	500	500	n/a
13" reel qty	12,000	10,000	8,000	2,000	2,000	2,000	2,000	500

Note: Other capacitance values may become available, please contact the Sales Office if you need values other than those shown in the above table. For dimensions and soldering information, visit knowlescapacitors.com.

ORDERING INFORMATION — VC1 CAPACITORS

1206	Y	1K0	0152	K	X	T	VC1
Chip size	Termination	Voltage	Capacitance in picofarads (pF)	Capacitance tolerance	Dielectric	Packaging	Suffix
0805 1206 1210 1808 1812 2220 2225 3640	Y = FlexiCap™ termination base with nickel barrier (100% matte tin plating). RoHS compliant. H = FlexiCap™ termination base with Ni barrier (Tin/lead plating with min. 10% lead). Not RoHS compliant.	250 = 250V 500 = 500V 630 = 630V 1K0 = 1kV 1K2 = 1.2kV 1K5 = 1.5kV 2K0 = 2.0kV 2K5 = 2.5kV 3K0 = 3.0kV	First digit is zeros. Second and third digits are significant figures of capacitance code. The fourth digit is number of zeros following Example: 0152 = 1500pF	J = ±5% K = ±10% M = ±20%	X = X7R	T = 178mm (7") reel R = 330mm (13") reel B = Bulk pack — tubs	

TCC/VCC Capacitors — (BX and BZ) X7R

X7R capacitors with a defined capacitance variation under applied dc voltage, across the full operating temperature range.

While the capacitance of COG/NP0 chips does not vary with applied voltage, standard X7R capacitors exhibit capacitance fluctuation, but with no specified limit.

For applications where a limit is required, Knowles is able to offer either a “B” code dielectric (conforms to MIL “BX” dielectric and IECQ-CECC “2X1”) or “R” code dielectric (conforms to MIL “BZ” dielectric and IECQ-CECC “2C1”).

TCC/VCC CAPACITORS — 2X1 (BX)

Cap. Code	0603	0805	1206	1210	1808	1812	2220	2225	Cap. Code
100pF 101	50V	100V	50V	100V	200V				100pF 101
120 121									120 121
150 151									150 151
180 181									180 181
220 221									220 221
270 271									270 271
330 331									330 331
390 391									390 391
470 471									470 471
560 561									560 561
680 681			50V	100V	200V				680 681
820 821									820 821
1.0nF 102				50V	100V	200V			1.0nF 102
1.2 122									1.2 122
1.5 152									1.5 152
1.8 182									1.8 182
2.2 222									2.2 222
2.7 272									2.7 272
3.3 332					50V	100V	200V		3.3 332
3.9 392									3.9 392
4.7 472									4.7 472
5.6 562									5.6 562
6.8 682									6.8 682
8.2 822									8.2 822
10 103									10 103
12 123									12 123
15 153									15 153
18 183									18 183
22 223									22 223
27 273									27 273
33 333									33 333
39 393									39 393
47 473									47 473
56 563									56 563
68 683									68 683
82 823									82 823
100 104									100 104
120 124									120 124
150 154									150 154
180 184									180 184
220 224									220 224
270 274									270 274
330 334									330 334
390 394									390 394
470 474									470 474
560 564									560 564
680 684									680 684
820 824									820 824
1.0µF 105									1.0µF 105
1.2µF 125									1.2µF 125
1.5µF 155									1.5µF 155

● = non-RoHS compliant and FlexiCap™ termination only. Other values available in J, Y (FlexiCap™) and F terminations.



TCC/VCC Capacitors — (BX and BZ) X7R

TCC/VCC CAPACITORS — 2C1 (BZ)

Cap. Code	0603	0805	1206	1210	1808	1812	2220	2225	Cap. Code
100pF 101	50V	100V							100pF 101
120 121									120 121
150 151									150 151
180 181									180 181
220 221									220 221
270 271									270 271
330 331									330 331
390 391									390 391
470 471									470 471
560 561									560 561
680 681			50V	100V	200V				680 681
820 821									820 821
1.0nF 102									1.0nF 102
1.2 122									1.2 122
1.5 152									1.5 152
1.8 182									1.8 182
2.2 222									2.2 222
2.7 272									2.7 272
3.3 332									3.3 332
3.9 392									3.9 392
4.7 472									4.7 472
5.6 562									5.6 562
6.8 682									6.8 682
8.2 822									8.2 822
10 103									10 103
12 123									12 123
15 153									15 153
18 183									18 183
22 223									22 223
27 273									27 273
33 333									33 333
39 393									39 393
47 473									47 473
56 563									56 563
68 683									68 683
82 823									82 823
100 104									100 104
120 124									120 124
150 154									150 154
180 184									180 184
220 224									220 224
270 274									270 274
330 334									330 334
390 394									390 394
470 474									470 474
560 564									560 564
680 684									680 684
820 824									820 824
1.0μF 105									1.0μF 105
1.2μF 125									1.2μF 125
1.5μF 155									1.5μF 155

● = non-RoHS compliant and FlexiCap™ termination only. Other values available in J, Y (FlexiCap™) and F terminations.

ORDERING INFORMATION — TCC/VCC CAPACITORS

Chip size	Termination	Voltage	Capacitance in picofarads (pF)	Capacitance tolerance	Dielectric	Packing	Suffix code
0603	J	050	0471	J	B	B	---
0603	Y = FlexiCap™ termination base with Ni barrier (100% matte tin plating). RoHS compliant.	050 = 50V 100 = 100V 200 = 200V	1st digit is 0. 2nd and 3rd digits are significant figures of capacitance code. The 4th digit is number of 0's following eg. 0471 = 470pF 0824 = 820nF	G = ±2% J = ±5% K = ±10% M = ±20%	B = 2X1/BX released in accordance with IECQ-CECC R = 2C1/BZ released in accordance with IECQ-CECC	T = 178mm (7") reel R = 330mm (13") reel B = Bulk pack — tubs	Used for specific customer requirements

Open Mode Capacitors — COG/NP0 (1B) and X7R (2R1)



Open Mode capacitors have been designed specifically for use in applications where mechanical cracking is a severe problem and short circuits due to cracking are unacceptable.

Open Mode capacitors use inset electrode margins, which prevent any mechanical cracks that may form during board assembly from connecting to the internal electrodes.

When combined with FlexiCap™ termination, Open Mode capacitors provide a robust component with the assurance that if a part becomes cracked, the crack will be unlikely to result in short circuit failure.

Qualification included cracking the components by severe bend tests. Following the bend tests, cracked components were subjected to endurance/humidity tests, with no failures evident due to short circuits. Note: Depending on the severity of the crack, capacitance loss was between 0% and 70%. Note: Blue Background = AEC-Q200.

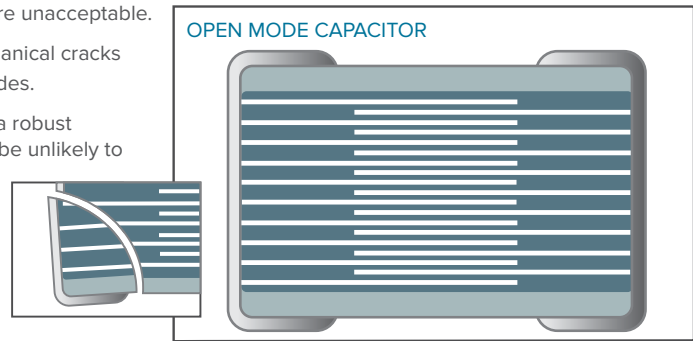

OPEN MODE — COG/NP0 (1B) — CAPACITANCE VALUES

COG/NP0 (1B)	0603	0805	1206	1210	1808	1812	2220	2225
Max. Thickness	0.8mm	1.37mm	1.7mm	2.0mm	2.0mm	2.5mm	2.5mm	2.5mm
Min cap	10pF	10pF	10pF	22pF	22pF	47pF	68pF	100pF
16/25V	220pF	1.0nF	2.2nF	5.6nF	5.6nF	10nF	15nF	18nF
50/63V	220pF	1.0nF	2.2nF	5.6nF	5.6nF	10nF	15nF	18nF
100V	220pF	1.0nF	2.2nF	5.6nF	5.6nF	10nF	15nF	18nF
200/250V	150pF	680pF	1.8nF	3.9nF	3.9nF	10nF	15nF	18nF
500V	—	470pF	1.0nF	2.2nF	2.2nF	5.6nF	15nF	18nF
630V	—	220pF	560pF	1.8nF	1.8nF	5.6nF	15nF	18nF
1kV	—	47pF	220pF	470pF	470pF	1.0nF	2.7nF	3.3nF

OPEN MODE — X7R (2R1) — CAPACITANCE VALUES

X7R (2R1)	0603	0805	1206	1210	1808	1812	1825	2220	2225						
Max. Thickness	0.8mm	1.37mm	1.7mm	2.0mm	2.0mm	2.5mm	2.5mm	2.5mm	2.5mm						
Min cap	100pF	100pF	100pF	100pF	100pF	150pF	—	220pF	330pF						
16V	22nF	39nF	100nF	150nF	220nF	470nF	470nF	680nF	680nF	470nF	1.5μF	—	560nF	3.3μF	4.7μF
25V	22nF	33nF	100nF	120nF	220nF	330nF	470nF	560nF	560nF	470nF	1.2μF	—	560nF	2.2μF	3.9μF
50/63V	22nF	100nF	220nF	470nF	470nF	470nF	1μF	—	1.5μF	—	—	—	1.5μF	2.7μF	
100V	6.8nF	27nF	100nF	220nF	220nF	680nF	—	—	1μF	—	—	—	1μF	1.5μF	1.8μF
200/250V	2.7nF	22nF	68nF	100nF	100nF	330nF	560nF	680nF	680nF	—	—	—	1μF	—	
500V	—	5.6nF	39nF	68nF	68nF	180nF	330nF	330nF	330nF	—	—	—	470nF	100nF	
630V	—	—	22nF	33nF	33nF	100nF	220nF	180nF	330nF	—	—	—	330nF	330nF	
1kV	—	—	6.8nF	15nF	15nF	47nF	100nF	100nF	100nF	—	—	—	100nF	150nF	
1.5kV	—	—	—	—	10nF	6.8nF	22nF	47nF	56nF	—	—	—	56nF	68nF	
2kV	—	—	—	—	3.3nF	2.7nF	8.2nF	10nF	22nF	—	—	—	22nF	27nF	
3kV	—	—	—	—	1.5nF	560pF	1.8nF	3.9nF	5.6nF	—	—	—	5.6nF	6.8nF	

ORDERING INFORMATION — OPEN MODE CAPACITORS

1206	Y	050	0224	K	X	T	---		
Chip Size	Termination	Voltage		Capacitance in Picofarads (pF)	Capacitance Tolerance	Dielectric Release Codes		Packaging	Suffix Code
0603 0805 1206 1210 1808 1812 1825 2220 2225	Y = FlexiCap™ termination base with nickel barrier (100% matte tin plating). RoHS compliant.	016 = 16V 050 = 50V 100 = 100V 250 = 250V 630 = 630V	025 = 25V 063 = 63V 200 = 200V 500 = 500V 1K0 = 1kV	First digit is 0. Second and third digits are significant figures of capacitance code. The fourth digit is number of zeros following. Example: 0224 = 220000pF	F = ±1% G = ±2% J = ±5% K = ±10% M = ±20% Note: X7R (2R1) parts are available in J, K & M tolerances only.	A = COG/NP0 (1B) to AEC-Q200 E = X7R (2R1) to AEC-Q200 - original S = X7R (2R1) to AEC-Q200 - recommended C = COG/NP0 (1B) X = X7R (2R1) - original J = X7R (2R1) - recommended	T = 178mm (7") reel R = 330mm (13") reel B = Bulk pack — tubs or trays	M01 = Open Mode capacitor	



Tandem Capacitors — X7R (2R1)



Tandem capacitors have been designed as a fail safe range, using a series section internal design, for use in any application where short circuits would be unacceptable.

When combined with FlexiCap™ termination, Tandem capacitors provide an ultra robust and reliable component, for use in the most demanding applications.

Non-standard voltages are available. For more information, please consult the Knowles Capacitors Sales Office.

Qualification included cracking the components by severe bend tests. Following the bend tests, cracked components were subjected to endurance/humidity tests, with no failures evident due to short circuits. Note: Depending on the severity of the crack, capacitance loss was between 0% and 50%.

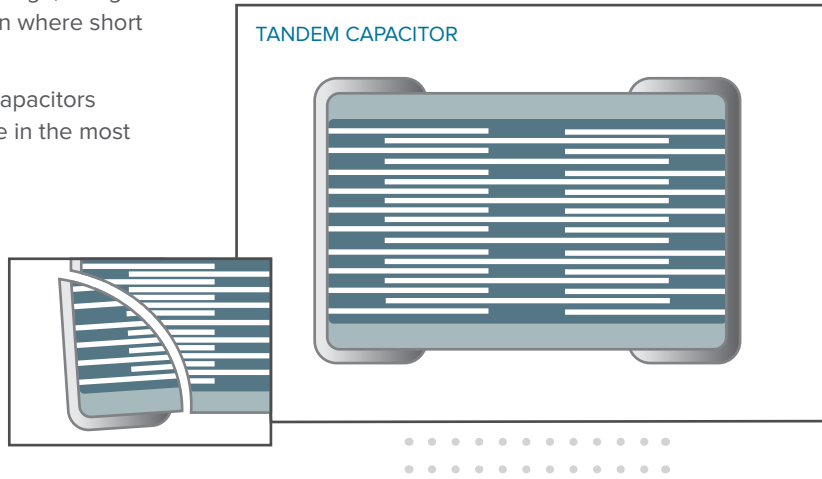

TANDEM — X7R (2R1) — CAPACITANCE VALUES

X7R (2R1)	0603	0805	1206	1210	1812	2220	2225
Max. Thickness	0.8mm	1.39mm	1.7mm	2.0mm	2.0mm	2.5mm	2.5mm
Min cap	100pF	100pF	100pF	100pF	150pF	220pF	330pF
16V	12nF	47nF	150nF	270nF	560nF	1.2µF	1.5µF
25V	10nF	39nF	120nF	220nF	470nF	1µF	1.2µF
50/63V	6.8nF	33nF	100nF	180nF	390nF	680nF	1µF
100V	2.2nF	10nF	47nF	82nF	220nF	470nF	680nF
200/250V	1nF	4.7nF	22nF	47nF	100nF	220nF	330nF

Note: Blue Background= AEC-Q200.

ORDERING INFORMATION — TANDEM CAPACITORS

1206	Y	050	0224	K	X	T	---
Chip Size	Termination	Voltage	Capacitance in Picofarads (pF)	Capacitance Tolerance	Dielectric Codes	Packaging	Suffix Code
0603 0805 1206 1210 1812 2220 2225	Y = FlexiCap™ termination base with nickel barrier (100% matte tin plating). RoHS compliant.	050 = 50V 063 = 63V 100 = 100V 200 = 200V 250 = 250V	First digit is 0. Second and third digits are significant figures of capacitance code. The fourth digit is number of zeros following. Example: 0224 = 220000pF	J = ±5% K = ±10% M = ±20%	E = X7R (2R1) to AEC-Q200 — original X = X7R (2R1)	T = 178mm (7") reel R = 330mm (13") reel B = Bulk pack — tubs or trays	T01 = Tandem capacitor

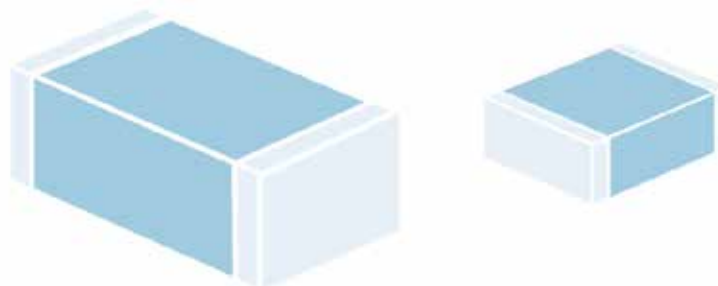

IECQ-CECC Range — Specialty High Reliability and Approved Parts

A range of specialist, high reliability, multilayer ceramic capacitors for use in critical or high reliability environments. All fully tested/approved and available with a range of suitable termination options, including tin/lead plating and Knowles FlexiCap™.



Ranges include:

1. Range tested and approved in accordance with IECQ-CECC QC32100.
2. Range qualified to the requirements of Knowles detail specification S02A-0100 (based on ESCC 3009).

IECQ-CECC — MAXIMUM CAPACITANCE VALUES

		0603	0805	1206*	1210	1808	1812	2220	2225
16V	COG/NPO	1.5nF	6.8nF	22nF	33nF	33nF	100nF	150nF	220nF
	X7R	100nF	330nF	1.0µF	1.5µF	1.5µF	3.3µF	5.6µF	6.8µF
25V	COG/NPO	1.0nF	4.7nF	15nF	22nF	27nF	68nF	100nF	150nF
	X7R	56nF	220nF	820nF	1.2µF	1.2µF	2.2µF	4.7µF	5.6µF
50/63V	COG/NPO	470pF	2.7nF	10nF	18nF	18nF	33nF	68nF	100nF
	X7R	47nF	220nF	470nF	1.0µF	680nF	1.5µF	2.2µF	3.3µF
100V	COG/NPO	330pF	1.8nF	6.8nF	12nF	12nF	27nF	47nF	68nF
	X7R	10nF	47nF	150nF	470nF	330nF	1.0µF	1.5µF	1.5µF
200/250V	COG/NPO	100pF	680pF	2.2nF	4.7nF	4.7nF	12nF	22nF	27nF
	X7R	5.6nF	27nF	100nF	220nF	180nF	470nF	1.0µF	1.0µF
500V	COG/NPO	n/a	330pF	1.5nF	3.3nF	3.3nF	10nF	15nF	22nF
	X7R	n/a	8.2nF	33nF	100nF	100nF	270nF	560nF	820nF
1kV	COG/NPO	n/a	n/a	470pF	1.0nF	1.2nF	3.3nF	8.2nF	10nF
	X7R	n/a	n/a	4.7nF	15nF	18nF	56nF	120nF	150nF

*Maximum thickness for 1206 part is 1.6mm, 0.063"

ORDERING INFORMATION — IECQ-CECC RANGE

1210	Y	100	0103	J	D	T	---
Chip size	Termination	Voltage	Capacitance in picofarads (pF)	Capacitance tolerance	Dielectric Release codes	Packaging	Suffix code
0603 0805 1206 1210 1808 1812 2220 2225	<p>Y = FlexiCap™ termination base with Ni barrier (100% matte tin plating). RoHS compliant.</p> <p>H = FlexiCap™ termination base with Ni barrier (Tin/lead plating with min. 10% lead). Not RoHS compliant.</p> <p>F = Silver Palladium. RoHS compliant.</p> <p>J = Nickel barrier (100% matte tin plating). RoHS compliant. Lead free.</p> <p>A = Nickel barrier (Tin/lead plating with min. 10% lead). Not RoHS compliant.</p>	<p>016 = 16V 025 = 25V 050 = 50V 063 = 63V 100 = 100V 200 = 200V 250 = 250V 500 = 500V 630 = 630V 1K0 = 1kV</p>	<p>First digit is 0.</p> <p>Second and third digits are significant figures of capacitance code.</p> <p>The fourth digit is number of zeros following</p> <p>Example: 0103 = 10nF</p>	<p><10pF B = ±0.1pF C = ±0.25pF D = ±0.5pF ≥10pF F = ±1% G = ±2% J = ±5% K = ±10% M = ±20%</p>	<p>D = X7R (2R1) with IECQ-CECC release</p> <p>F = COG/NPO (1B/NP0) with IECQ-CECC release</p> <p>B = 2X1/BX released in accordance with IECQ-CECC</p> <p>R = 2C1/BZ released in accordance with IECQ-CECC</p> <p>For B and R codes, please refer to TCC/VCC range for full capacitance values</p>	<p>T = 178mm (7") reel R = 330mm (13") reel B = Bulk pack — tubes or trays</p>	Used for specific customer requirements



High Capacitance Chip — X7R and X5R

A range of High Capacitance value BME MLC chip capacitors, in stable Class II dielectrics X7R and X5R, with a spread of capacitance values offered up to 100µF.

Comparable circuit designs can be achieved at typically a third to a fifth of the capacitance values because of the low ESR characteristics these parts exhibit. As a consequence, they are also ideal to replace Tantalum and Low ESR Electrolytic capacitors without polarity concerns. They find application as power supply bypass capacitors, smoothing capacitors, input/output filters in DC-DC converters and in digital circuits and LCD modules.

Parts are RoHS compliant and suitable for reflow soldering process.

- Nickel barrier terminations with tin, tin/lead or gold flash
- Capacitance tolerances available: ±10%, ±20%
- Available with high reliability screening. Contact the Knowles Precision Devices Sales Office

CAPACITANCE VALUES — HIGH CAPACITANCE CHIP

Size		0402		0603		0805		1206		1210		1812	
Tmax	inches: mm:	0.024 0.61		0.035 0.89		0.054 1.37		0.072* 1.83		0.085* 2.16		0.110* 2.79	
Dielectric		X7R	X5R	X7R	X5R	X7R	X5R	X7R	X5R	X7R	X5R	X7R	X5R
4V					22µF [†]				100µF [†]				-
6.3V	470nF		1µF 2.2µF [†] 4.7µF [†]		4.7µF 10µF [†]		22µF [†]		47µF [†]		47µF [†]	100µF [†]	-
10V			1µF	2.2µF	4.7µF 10µF [†]	10µF [†]	10µF	22µF [†]	22µF [†]		22µF [†]		47µF [†]
16V	15nF 22nF 33nF 47nF 100nF 220nF		22nF 47nF 100nF 220nF 470nF		100nF 1µF	2.2µF 4.7µF	4.7µF 10µF	10µF	10µF 22µF [†]	4.7µF [†] 10µF [†]			22µF [†]
25V	6.8nF 10nF 47nF 100nF		10nF 220nF	470nF 1.0µF	220nF 470nF 1.0µF 2.2µF	1.0µF 2.2µF 4.7µF	2.2µF 4.7µF	2.2µF 4.7µF 10µF	4.7µF 10µF	3.3µF [†] 4.7µF [†]	4.7µF [†] 10µF [†]	22µF [†]	-
35V											2.2µF [†] 4.7µF [†]		10µF
50V	10nF	100nF	220nF 470nF	100nF 470nF 1.0µF	220nF 470nF 1.0µF	220nF 470nF 1.0µF 2.2µF	470nF 1.0µF 2.2µF 4.7µF	4.7µF	1.0µF		4.7µF [†]	4.7µF [†] 10µF [†]	-
100V			100nF		220nF		1.0µF			1.0µF 2.2µF			1.0µF 2.2µF

* Denotes non-standard chip thickness. Order code needs to have an "X" inserted together with the dimension in inches, e.g., X072 where dimension is 0.072".

† Denotes only available in ±20% capacitance tolerance.



High Capacitance Chip — X7R and X5R

COMPARISON WITH OTHER DIELECTRIC CAPACITORS

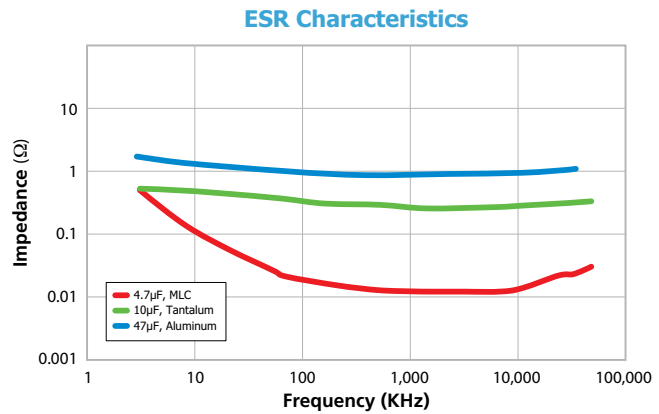
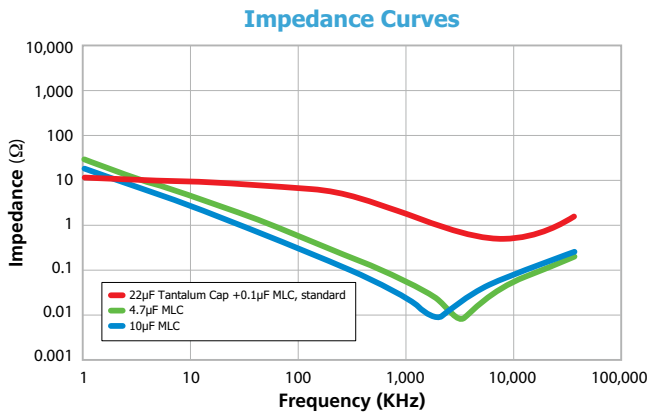

DIELECTRIC CHARACTERISTICS

	X7R (BB) Stable	X5R (BW) Stable
Operating temperature range:	-55°C to 125°C	-55°C to 85°C
Temperature coefficient:	±15% ΔC Max.	±15% ΔC Max.
Dissipation factor:	3.5%, max, except: 0402 ≥ 0.1µF = 5%, 0603 ≥ 0.22µF = 10%, 0805 ≥ 1.0µF = 5%, 0805 ≥ 2.2µF = 10%, 1206 ≥ 2.2µF = 10%, 1210 ≥ 4.7µF = 5%, 1210 ≥ 22µF = 10%	5%, max, except: 0402 ≥ 1.0µF = 10%, 0603 ≥ 1.0µF = 10%, 0805 ≥ 4.7µF = 10%, 1206 ≥ 4.7µF = 10%, 1210 ≥ 10µF = 10%
Insulation resistance @25°C:	>10GΩ or >100ΩF, whichever is less	>10GΩ or >100ΩF, whichever is less
Dielectric withstanding voltage:	250%	250%
Aging rate:	X7R 3.5% typical	X5R 5% typical
Test parameters @ 25°C:	1KHz, 1.0 ±0.2 VRMS	1KHz, 1.0 ±0.2 VRMS
		120Hz, 0.5 ±0.1 VRMS for 22µF, 47µF & 100µF

ORDERING INFORMATION — HIGH CAPACITANCE CHIP CAPACITORS

1206	W	476	K	6R3	N	X080	T
Chip Sizes	Dielectric	Capacitance	Tolerance	Voltage-VDCW	Termination	Thickness option	Packing
0402 0603 0805 1206 1210 1812	BB* = X7R BW* = X5R *Formerly B & W codes	Value in Picofarads. Two significant figures, followed by number of zeros: 476 = 47µF (47,000,000pF)	K = ± 10% M = ± 20%	Two significant figures, followed by number of zeros. R denotes decimal point: 6R3 = 6.3V 501 = 500V	N = Nickel Barrier (100% tin) Y = Nickel Barrier (90% tin/10% lead) NG = Nickel Barrier Gold Flash	Blank = Standard thickness X = special thickness, specified in inches: X085 = 0.085"	No suffix = Bulk T = Tape & Reel

Note: BME parts available with added high reliability test. Consult the factory.



StackiCap™ Capacitors — AEC-Q200 and Standard Ranges



The StackiCap™ range offers a significant reduction in "PCB real estate" for an equivalent capacitance value when board space is at a premium. For example, a standard 150nF chip in an 8060 case size is now available in a much smaller 3640 case size.

Knowles Precision Devices' unique patented* construction and FlexiCap™ termination material make the StackiCap™ range suitable for applications including: power supplies, lighting, aerospace electronics and high voltage applications where a large amount of capacitance is required. Further developments are ongoing, please contact the Knowles Precision Devices sales office for details of the full range.

*StackiCap™ technology is protected by international patents (pending) EP2847776, WO2013186172A1, US20150146343A1 and CN104471660A.



MAXIMUM CAPACITANCE: Up to 5.6μF

MAXIMUM VOLTAGE: Up to 2kV

INSULATION RESISTANCE: Time Constant (RxCr) (whichever is the least — 500s or 500MΩ)

CAPACITANCE VALUES — STACKICAP™ CAPACITORS

Chip Size	1812	2220	2225	3640
Max. Thickness	3.5mm	4.5mm	4.5mm	4.2mm
200/250V	820nF - 1.0μF	1.2μF - 2.2μF	2.2μF	3.9μF - 5.6μF
500V	390nF - 470nF	680nF - 1.2μF	1.2μF	1.2μF - 2.7μF
630V	220nF - 330nF	390nF - 1.0μF	820nF - 1μF	820nF - 2.2μF
1kV	120nF - 180nF	150nF - 470nF	-	220nF - 1μF
1.2kV	(39nF - 100nF)	(100nF - 220nF)	-	(180nF - 470nF)
1.5kV	(27nF - 56nF)	(56nF - 150nF)	-	(120nF - 330nF)
2kV	-	(39nF - 100nF)	-	(56nF - 150nF)

Note: Blue Background = AEC-Q200 | Values shown in parentheses require conformal coating after mounting (suffix code WS3 applies). All other values use suffix code WS2.

ORDERING INFORMATION — STACKICAP™ CAPACITORS

Chip Size	Termination	Voltage	Capacitance in Picofarads (pF)	Capacitance tolerance	Dielectric	Packaging	Suffix code
1812 2220 2225 3640	Y = FlexiCap™ termination base with nickel barrier (100% matte tin plating). RoHS compliant. Lead free. H = FlexiCap™ Termination base with nickel barrier (Tin/lead plating with minimum 10% lead). Not RoHS compliant. 7 = FlexiCap™ Termination base with nickel barrier (Tin/lead plating with 5-20% lead). Not RoHS compliant.	200 = 200V 250 = 250V 500 = 500V 630 = 630V 1K0 = 1kV 1K2 = 1.2kV 1K5 = 1.5kV 2K0 = 2kV	First digit is 0. Second and third digits are significant figures of capacitance code in picofarads (pF). Fourth digit is number of zeros; e.g., 0474 = 470nF Values are E12 series.	J = ±5% K = ±10% M = ±20%	E = X7R (2R1) to AEC-Q200 X = X7R (2R1)	T = 178mm (7") reel R = 330mm (13") reel B = Bulk pack — tubs or trays	WS2 WS3

Note: Suffix code WS3 applies to parts with a rated voltage ≥ 1.2kV, and indicates conformal coating is required after mounting. For all other parts use suffix code WS2.

REELED QUANTITIES — STACKICAP™ CAPACITORS

	1812	2220	2225	3640
178mm (7") Reel	500	500	500	-
330mm (13") Reel	2,000	2,000	2,000	500



Note:
Parts in this range may be defined as dual-use under export control legislation and may be subject to export license restrictions. Please refer to page 15 for more information on the dual-use regulations and contact the Knowles Precision Devices sales office for further information on specific part numbers.



Hiteca™ Capacitors — AEC-Q200 and Standard Ranges



The Hiteca™ range of MLCCs utilises a unique patented dielectric system that offers improved capacitance stability and lower parasitic losses under common operating conditions, compared to standard Class II dielectrics such as X7R.

Combined with a capacitance ageing rate of 0, this range is particularly suited for applications such as DC bus and snubber capacitors, where high capacitance values under full rated voltage are required.

The inherent low loss enables these devices to handle much higher ripple currents than conventional ceramic capacitors, making them market leaders for power electronic applications.



MAXIMUM CAPACITANCE: Up to 680nF

MAXIMUM VOLTAGE: Up to 2kV

INSULATION RESISTANCE: 100G or 1000 secs (whichever is the least)

CAPACITANCE VALUES — HITECA™ CAPACITORS

Standard Thickness Parts (Standard Commercial & AEC-Q200 ranges)

Chip Size	1206	1210	1812	1825	2220	2225
Max. Thickness	1.7mm	2.0mm	2.5mm	2.5mm	2.5mm	2.5mm
200/250V	100pF - 33nF	100pF - 82nF	100pF - 220nF	220pF - 390nF	220pF - 390nF	470pF - 470nF
450V	100pF - 18nF	100pF - 47nF	100pF - 150nF	220pF - 270nF	220pF - 270nF	470pF - 330nF
500V	100pF - 15nF	100pF - 39nF	100pF - 120nF	220pF - 150nF	220pF - 150nF	470pF - 180nF
630V	100pF - 10nF	100pF - 22nF	100pF - 68nF	220pF - 220nF	220pF - 220nF	470pF - 270nF
1kV	100pF - 3.9nF	100pF - 10nF	100pF - 27nF	220pF - 12nF	220pF - 12nF	470pF - 68nF
1.2kV	100pF - 2.7nF	100pF - 6.8nF	100pF - 18nF	220pF - 22nF	220pF - 22nF	470pF - 47nF
1.5kV	100pF - 2.2nF	100pF - 4.7nF	100pF - 12nF	220pF - 39nF	220pF - 39nF	470pF - 33nF
2kV	100pF - 1.0nF	100pF - 2.2nF	100pF - 6.8nF	220pF - 56nF	220pF - 56nF	470pF - 18nF

Non Standard Thickness Parts (Standard Commercial range only)

Chip Size	1206	1210	1812	1825	2220	2225
Max. Thickness	1.7mm	2.8mm	3.2mm	4.0mm	4.0mm	4.0mm
200/250V	-	100nF - 120nF	270nF - 270nF	470nF - 560nF	470nF - 560nF	560nF - 680nF
450V	-	56nF - 82nF	180nF - 180nF	330nF - 470nF	330nF - 470nF	390nF - 560nF
500V	-	47nF - 56nF	150nF - 150nF	270nF - 390nF	270nF - 390nF	330nF - 470nF
630V	-	27nF - 39nF	82nF - 100nF	180nF - 270nF	180nF - 270nF	220nF - 330nF
700V	-	12nF - 33nF	33nF - 82nF	68nF - 220nF	68nF - 220nF	82nF - 270nF
900V	-	12nF - 22nF	33nF - 47nF	68nF - 120nF	68nF - 120nF	82nF - 180nF
1kV	-	12nF - 18nF	33nF - 39nF	68nF - 100nF	68nF - 100nF	82nF - 120nF
1.2kV	-	8.2nF - 12nF	22nF - 27nF	47nF - 68nF	47nF - 68nF	56nF - 82nF
1.5kV	-	5.6nF - 6.8nF	15nF - 18nF	27nF - 47nF	27nF - 47nF	39nF - 56nF
2kV	-	2.7nF - 3.9nF	8.2nF - 10nF	15nF - 27nF	15nF - 27nF	22nF - 33nF

Note: Parts in this range may be defined as dual use under export control legislation, and as such may be subject to export licence restrictions.

Please refer to page 15 for more information on the dual-use regulations and contact the Sales Office for further information on specific part numbers.



Hiteca™ Capacitors — AEC-Q200 and Standard Ranges

DIELECTRIC CHARACTERISTICS

Operating temperature range:	-55°C to 125°C
Temperature coefficient:	±15% ΔC Max.
Typical capacitance drop at maximum operating voltage	<45%
Insulation resistance @25°C:	100G or 1000secs (whichever is the less)
Dielectric withstanding voltage:	Voltage applied for 5 ±1 seconds, 50mA charging current maximum
Aging rate:	Zero

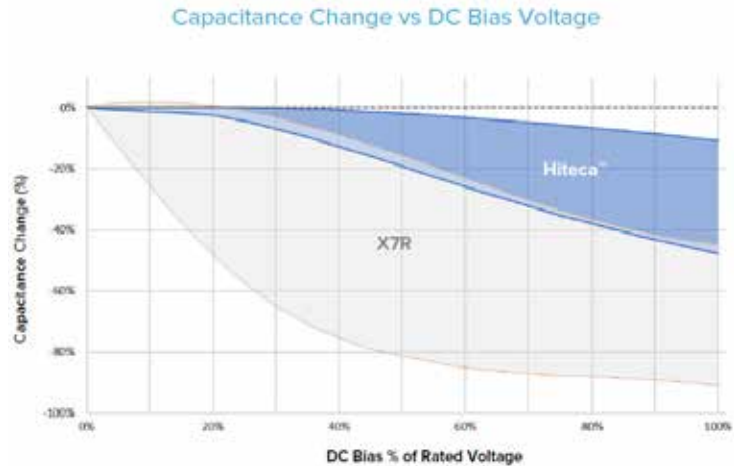

ORDERING INFORMATION — HITECA™ CAPACITORS

1812	Y	500	0474	K	J	T
Chip Size	Termination	Voltage	Capacitance in Picofarads (pF)	Capacitance tolerance	Dielectric Release codes	Packaging
1206 1210 1812 1825 2220 2225	Y = FlexiCap™ termination base with nickel barrier (100% matte tin plating). RoHS compliant. Lead free. 8 = Unplated solderable silver (Z dielectric only, RoHS compliant)	200 = 200V 250 = 250V 450 = 450V 500 = 500V 630 = 630V 700 = 700V 900 = 900V 1K0 = 1kV 1K2 = 1200V 1K5 = 1500V 2K0 = 2000V	First digit is 0. Second and third digits are significant figures of capacitance code in picofarads (pF). Fourth digit is number of zeros; e.g., 0474 = 470nF. Values are E12 series.	J = ±5% K = ±10% M = ±20%	Y = Hiteca™ dielectric low loss stable (AEC-Q200) Z = Hiteca™ dielectric low loss stable (Standard Commercial)	T = 178mm (7") reel R = 330mm (13") reel B = Bulk pack — tubs or trays

REELED QUANTITIES — HITECA™ CAPACITORS

	1206	1210	1812	1825	2220	2225
178mm (7") Reel	2,500	2,000	500	500	500	500
330mm (13") Reel	10,000	8,000	2,000	2,000	2,000	2,000



Leaded Standoff MLCC High Voltage — (COG and X7R)

- Enhanced performance under critical testing conditions such as thermal shock and mechanical vibration
- Capable of 3000 thermal cycles with no degradation of interconnect when mounted to FR4 board
- Suitable for both industrial and automotive markets
- Offers 3kV and 4kV parts to satisfy the demands of 800V battery system DWV testing
- High voltage ratings allow for component de-rating in application



RANGE DIMENSIONS - LEADED OPTIONS

Chip size	Length (L1) mm/inches	Width (W) mm/inches	Width (W1) mm/inches	Max. Thickness (T) mm/inches	Lead Width (L2 & L3) mm/inches	STAND OFF mm/inches
					Typical	Typical
2220	5.7 ± 0.40	5.0 ± 0.4	5.10 ± 0.20	5.5	0.7	1.0
	0.225 ± 0.016	0.197 ± 0.016	0.200 ± 0.008	0.217	0.028	0.039
2225	5.7 ± 0.4	6.3 ± 0.4	5.10 ± 0.20	5.5	0.7	1.0
	0.225 ± 0.016	0.252 ± 0.016	0.200 ± 0.008	0.217	0.028	0.039

ORDERING INFORMATION

2220	B	1K0	0104	J	E	T	J	
Chip size	Termination	Voltage	Capacitance in picofarads (pF)	Capacitance tolerance	Dielectric codes	Packaging	Mounting Style	Suffix code
2220 2225	B = Metal frame J-lead terminal	016 = 16V 025 = 25V 050 = 50V 063 = 63V 100 = 100V 200 = 200V 250 = 250V 500 = 500V 630 = 630V 1K0 = 1kV 1K2 = 1.2kV 1K5 = 1.5kV 2K0 = 2kV 2K5 = 2.5kV 3K0 = 3kV 4K0 = 4kV 5K0 = 5kV 6K0 = 6kV	<p><1.0pF</p> <p>Insert a P for the decimal point as the first character. e.g., P300 = 0.3pF</p> <p>Values in 0.1pF steps</p> <p>≥1.0pF & <10pF</p> <p>Insert a P for the decimal point as the second character. e.g., 8P20 = 8.2pF</p> <p>Values are E24 series</p> <p>≥10pF</p> <p>First digit is 0.</p> <p>Second and third digits are significant figures of capacitance code.</p> <p>The fourth digit is the number of zeros following. e.g., 0101 = 100 pF</p> <p>Values are E12 series</p>	F = ± 1% G = ± 2% J = ± 5% K = ± 10% M = ± 20%	E = X7R (2R1) S = X7R (2R1) AEC-Q200	T = 178mm (7") reel R = 330mm (13") reel B = Bulk pack – tubs or trays	J = 'J' Leaded Assembly	Used for specific customer requirements & variants W001 = Standard Variant



250Vac Rated 50/60Hz AC Capacitors — COG/NPO and X7R

Industry-wide standard multilayer ceramic capacitors are supplied with a DC rating only. For AC use, Surge and Safety capacitors with an AC rating of 250Vac have been available, but the capacitance range is limited as a result of the strict impulse and VP requirements in the international standards. Knowles has developed a range that provides a solution for use at up to 250Vac 60Hz continuous use and provides for non-safety-critical applications where extended capacitance ranges are required.

CAPACITANCE RANGE

Case sizes 0805 to 2220 are available in both X7R and COG/NPO dielectrics with capacitances of up to 120nF. The capacitance ranges are divided into four groups, which are based on the voltage coefficient of capacitance, COG/NPO, which has negligible capacitance shift with applied voltage, and three subgroups of X7R. Type A with $\pm 30\%$ maximum capacitance shift 0V-240V, Type B with +30% to -50% maximum capacitance shift 0V-240V and Type C with +30 to -80% maximum capacitance shift 0V to 240V.

250VAC RATED 50/60HZ AC CAPACITORS — MINIMUM/MAXIMUM CAPACITANCE VALUES

Chip size	0805	1206	1210	1808	1812	2220
COG/NPO	1.0pF-470pF	1.0pF-1.2nF	4.7pF-2.2nF	4.7pF-2.2nF	10pF-5.6nF	10pF - 10nF
X7R A $\pm 30\%$	560pF-1.5nF	1.5nF-10nF	2.7nF-22nF	2.7nF-22nF	6.8nF-68nF	12nF-120nF
X7R B +30% -50%	1.8nF-3.3nF	12nF	27nF	27nF	68nF-82nF	-
X7R C +30% -80%	3.9nF-10nF	15nF-47nF	33nF-100nF	33nF-100nF	100nF-120nF	-

Note: X7R A) has a VCC of $\pm 30\%$ over 0 to 240Vac 60Hz

X7R B) has a VCC of +30% to -50% over 0 to 240Vac 60Hz

X7R C) has a VCC of +30% to -80% over 0 to 240Vac 60Hz

Measurement conditions described in Knowles Application Notes AN0033. Visit knowlescapacitors.com for further details.

ORDERING INFORMATION — 250VAC RATED 50/60HZ AC CAPACITORS

1812	Y	A25	0103	K	J	T
Chip size	Termination	Voltage	Capacitance in picofarads (pF)	Capacitance tolerance	Dielectric codes	Packaging
0805 1206 1210 1808 1812 2220	Y = FlexiCap™ termination base with nickel barrier (100% matte tin plating). RoHS compliant. J = Nickel barrier (100% matte tin plating). RoHS compliant. Lead free.	A25 = 250Vac 60Hz	<10pF Insert a P for the decimal point, e.g., P300 = 0.3pF, 8P20 = 8.2pF. ≥10pF 1st digit is 0. 2nd and 3rd digits are significant figures of capacitance code. The 4th digit is number of zeros following e.g., 0103 = 10nF	<10pF B = $\pm 0.1\text{pF}$ C = $\pm 0.25\text{pF}$ D = $\pm 0.5\text{pF}$ ≥10pF F = $\pm 1\%$ G = $\pm 2\%$ J = $\pm 5\%$ K = $\pm 10\%$ M = $\pm 20\%$	C = COG/NPO J = X7R (BME) X = X7R	T = 178mm (7") reel R = 330mm (13") reel B = Bulk pack — tubs or trays

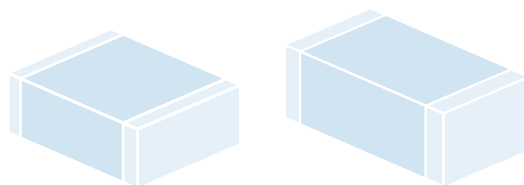

Safety Certified AC Capacitors



Knowles Safety Certified capacitors comply with international UL and TÜV specifications, offering designers the option of using a surface mount ceramic multilayer capacitor to replace leaded film types.

Offering the benefits of simple pick-and-place assembly, reduced board space required and a lower profile, they are also available as a FlexiCap™ version to reduce the risk of mechanical cracking.

Our high voltage expertise allows us to offer capacitance ranges that are among the highest in the market for selected case sizes.

Applications include: modems and other telecoms equipment, AC/DC power supplies, power distribution switchgear, automotive applications, and where lightning strikes or other voltage transients represent a threat to electronic equipment.



- Surface mount multilayer ceramic capacitors
- Case sizes 1808, 1812, 2211, 2215 and 2220
- Reduced board area and height restrictions
- Meet Class Y2, X1 and X2 requirements
- Reduced assembly costs over conventional through hole components
- Approved by UL and TÜV
- FlexiCap™ polymer termination option available on all sizes

OVERVIEW OF SAFETY CAPACITOR CLASSES

Class	Rated Voltage	Impulse Voltage	Insulation Bridging	May be used in Primary Circuit
Y1	250Vac	8000V	Double or Reinforced	Line to Protective Earth
Y2	250Vac	5000V	Basic or Supplementary*	Line to Protective Earth
Y3	250Vac	None	Basic or Supplementary*	-
Y4	150Vac	2500V	Basic or Supplementary*	Line to Protective Earth
X1	250Vac	4000V	-	Line to Line
X2	250Vac	2500V	-	Line to Line
X3	250Vac	None	-	Line to Line

Note: * 2 x Y2 or Y4 rated may bridge double or reinforced insulation when used in series.

KNOWLES' SAFETY CERTIFIED AC CAPACITOR RANGES

Knowles offers two Safety Certified capacitor ranges:

- Enhanced 250Vac and 305Vac — our latest range, recommended for new designs
- Legacy 250Vac — our original range, for existing applications

These ranges are covered on the following pages.



Enhanced 250Vac and 305Vac Safety Certified AC Capacitors



Our new range of Enhanced Safety Certified capacitors offers significant advantages over other safety certified MLCC ranges, including:

- 250Vac class Y2 ranges
- 305Vac class X1 and X2 ranges
- All ranges have a safety certified dc voltage rating (unique in the industry)
- Most ranges are certified as humidity robustness grade III (unique in the industry)

- Approved for mains voltages up to 250Vac 50/60Hz (class Y2) and 305Vac 50/60Hz (classes X1, X2)
- SYX & SYM range with DWV withstand to 4kVdc/3kVac – suitable for EV battery systems with high voltage test demands
- SYS range with reduced creepage class Y2 (250Vac)/X1 (305Vac) parts, offering a smaller part for use in equipment within the scope of IEC62368
- Certification specifications IEC/EN60384-14:2013+A1, UL60384-14 and CAN/CSA E60384-14:1
- CTI \geq 600

SYX/UYX/SYM/UYM FAMILY – Y2 (250VAC)/X1 (305VAC), 5KV IMPULSE

The Knowles SYX family offers guaranteed 4mm creepage class Y2/X1 safety capacitors, including humidity robustness grade III, 5kV impulse and a 1kVdc rating approved by TÜV and UL. The SYM range offers a select number of the SYX range but with an open mode design incorporated.

In addition, all components are 100% DWV tested to 4kVdc, and AQL tested to 4kVdc and 3kVac/2kVac for 60s. This makes the SYX & SYM ranges ideal for use in high voltage battery systems within electric vehicles.

Unmarked components (UYX & UYM suffix) can be offered with a 2.5kVdc rating and are designed to comply with, but are not approved to, EN60384-14.

Dielectric	Approval Body	SYX/UYX				SYM/UYM	
		1808	1812	2211	2215	2220	2220
COG/NPO (1B)	TÜV, UL	5.6pF - 220pF	5.6pF - 820pF	4.7pF - 1nF	820pF - 1nF	-	-
X7R (2R1)	TÜV, UL	82pF - 1.8nF	100pF - 4.7nF	100pF - 3.9nF	2.7nF - 6.8nF	150pF - 10nF	150pF - 10nF
Max. Thickness*		2.0mm	2.8mm	2.8mm	3.2mm	3.2mm	3.2mm

Notes: Blue Background = AEC-Q200.

* For lower capacitance values in this family, the maximum part thickness will be lower than the value shown. To find out the maximum thickness for a specific part, please use the Part Builder or Part Search application on the Knowles website to generate the component datasheet.



Enhanced 250Vac and 305Vac Safety Certified AC Capacitors



CONTINUED

SYS/UYS FAMILY – Y2 (250VAC)/X1 (305VAC), 5KV IMPULSE

The Knowles SYS family offers class Y2/X1 safety capacitors, including humidity robustness grade III, 5kV impulse and a 1kVdc rating, approved by TÜV and UL for use in machinery within the scope of IEC 62368. Unmarked components (UYS suffix) can be offered with a 2500Vdc rating and are designed to comply with, but are not approved to, EN60384-14.

SYS and UYS components have a creepage <4mm, and as a result, their safety certifications are only valid for applications within the scope of IEC 62368. Ref: EN60384-14, clause 4.8.1.3.

Dielectric	Approval Body	1808	1812
COG/NP0 (1B)	TÜV, UL	5.6pF - 220pF	5.6pF - 680pF
X7R (2R1)	TÜV, UL	82pF - 1.8nF	100pF - 3.9nF
Max. Thickness*		2.0mm	2.8mm

Notes: Blue Background = AEC-Q200.

* For lower capacitance values in this family, the maximum part thickness will be lower than the value shown. To find out the maximum thickness for a specific part, please use the Part Builder or Part Search application on the Knowles website to generate the component datasheet.

S3X/U3X FAMILY – X2 (305VAC) 2.5KV IMPULSE

The Knowles S3X family offers class 305Vac X2 safety capacitors, 2.5kV impulse and a 1kVdc rating, approved by TÜV and UL.

Unmarked components (U3X suffix) can be offered with a 1.5kVdc rating and are designed to comply with, but are not approved to, EN60384-14.

Dielectric	Approval Body	2220
COG/NP0 (1B)	TÜV, UL	-
X7R (2R1)	TÜV, UL	10nF - 56nF
Max. Thickness*		4.5mm

Notes: Blue Background = AEC-Q200.

* For lower capacitance values in this family, the maximum part thickness will be lower than the value shown. To find out the maximum thickness for a specific part, please use the Part Builder or Part Search application on the Knowles website to generate the component datasheet.

S2X/U2X FAMILY – X2 (250VAC), 2.5KV IMPULSE

The Knowles S2X family offers class 250Vac X2 safety capacitors, including humidity robustness grade III, 2.5kV impulse and a 1kVdc rating, approved by TÜV and UL.

Unmarked components (U2X suffix) can be offered with a 2.5kVdc rating and are designed to comply with, but are not approved to, EN60384-14.

Dielectric	Approval Body	1808	1812
COG/NP0 (1B)	TÜV, UL	10pF - 1nF	10pF - 1.5nF
X7R (2R1)	TÜV, UL	150pF - 5.6nF	150pF - 10nF
Max. Thickness*		2.0mm	2.0mm

Notes: Blue Background = AEC-Q200.

* For lower capacitance values in this family, the maximum part thickness will be lower than the value shown. To find out the maximum thickness for a specific part, please use the Part Builder or Part Search application on the Knowles website to generate the component datasheet.



Enhanced 250Vac and 305Vac Safety Certified AC Capacitors



CONTINUED

CLASSIFICATION AND APPROVAL SPECIFICATION

Chip Size	Suffix Code	Dielectric	Cap Range	Classification	Approval Specification	Approval Body	AEC-Q200
1808	SYX	C0G/NP0 (1B)	5.6pF to 220pF	Y2 (250Vac) + X1 (305Vac) UL/cUL FOWX2 + FOWX8	IEC/EN60384-14:2013+A1:2016 UL/CAN/CSA60384-14:2014	TÜV UL	TÜV & UL FULL RANGE
		X7R (2R1)	82pF to 1.8nF				
1808	SYS	C0G/NP0 (1B)	5.6pF to 220pF	Y2 (250Vac) + X1 (305Vac) for use in equipment within the spec of IEC62368 UL/cUL FOWX2 + FOWX8	IEC/EN60384-14:2013+A1:2016 UL/CAN/CSA60384-14:2014	TÜV UL	TÜV & UL FULL RANGE
		X7R (2R1)	82pF to 1.8nF				
1808	S2X	C0G/NP0 (1B)	10pF to 1.0nF	X2 (250Vac) UL/cUL FOWX2 + FOWX8	IEC/EN60384-14:2013+A1:2016 UL/CAN/CSA60384-14:2014	TÜV UL	TÜV & UL FULL RANGE
1812	SYX	C0G/NP0 (1B)	5.6pF to 820pF	Y2 (250Vac) + X1 (305Vac) UL/cUL FOWX2 + FOWX8	IEC/EN60384-14:2013+A1:2016 UL/CAN/CSA60384-14:2014	TÜV UL	TÜV & UL FULL RANGE
		X7R (2R1)	100pF to 4.7nF				
1812	S2X	C0G/NP0 (1B)	10pF to 1.5nF	X2 (250Vac) UL/cUL FOWX2 + FOWX8	IEC/EN60384-14:2013+A1:2016 UL/CAN/CSA60384-14:2014	TÜV UL	TÜV & UL FULL RANGE
		X7R (2R1)	150pF to 10nF				
2211	SYX	C0G/NP0 (1B)	4.7pF to 1nF	Y2 (250Vac) + X1 (305Vac) UL/cUL FOWX2 + FOWX8	IEC/EN60384-14:2013+A1:2016 UL/CAN/CSA60384-14:2014	TÜV UL	TÜV & UL FULL RANGE
		X7R (2R1)	100pF to 3.9nF				
2215	SYX	C0G/NP0 (1B)	820pF to 1nF	Y2 (250Vac) + X1 (305Vac) UL/cUL FOWX2 + FOWX8	IEC/EN60384-14:2013+A1:2016 UL/CAN/CSA60384-14:2014	TÜV UL	TÜV & UL FULL RANGE
		X7R (2R1)	2.7nF to 6.8nF				
2220	SYX	X7R (2R1)	150pF to 10nF	Y2 (250Vac) + X1 (305Vac) UL/cUL FOWX2 + FOWX8	IEC/EN60384-14:2013+A1:2016 UL/CAN/CSA60384-14:2014	TÜV UL	TÜV & UL FULL RANGE
2220	S3X	X7R (2R1)	10nF to 56nF	X2 (305Vac) UL/cUL FOWX2 + FOWX8	IEC/EN60384-14:2013+A1:2016 UL/CAN/CSA60384-14:2014	TÜV UL	TÜV & UL FULL RANGE

DIMENSIONS

Chip Size	Suffix Code	Length L1 mm (in)	Width (W) mm (in)	Maximum Thickness T* mm (in)	Termination Bands L2, L3 mm (in)	Creepage L4 mm (in)
1808	SYX/UYX	4.95 ± 0.35 (0.195 ± 0.014)	2.00 ± 0.30 (0.08 ± 0.012)	1.50 (0.06), 2.00 (0.08)	0.30 – 0.80 (0.012 – 0.030)	≥4 (≥0.0158)
	SYS/UYX	4.80 ± 0.35 (0.189 ± 0.014)	2.00 ± 0.30 (0.08 ± 0.012)	1.50 (0.06), 2.00 (0.08)	0.30 – 0.80 (0.012 – 0.030)	≥3.5 (≥0.0138)
	S2X/U2X	4.50 ± 0.35 (0.180 ± 0.014)	2.00 ± 0.30 (0.08 ± 0.012)	1.50 (0.06), 2.00 (0.08)	0.50 – 0.80 (0.020 – 0.030)	≥3 (≥0.118)
1812	SYX/UYX	4.95 ± 0.35 (0.195 ± 0.014)	3.20 ± 0.30 (0.126 ± 0.012)	1.50 (0.06), 2.00 (0.08), 2.54 (0.10), 2.80 (0.11)	0.30 – 0.80 (0.012 – 0.030)	≥4 (≥0.0158)
	SYS/UYX	4.80 ± 0.35 (0.189 ± 0.014)	3.20 ± 0.30 (0.126 ± 0.012)	1.50 (0.06), 2.00 (0.08), 2.54 (0.10), 2.80 (0.11)	0.30 – 0.80 (0.012 – 0.030)	≥3.5 (≥0.0138)
2211	SYX/UYX	5.70 ± 0.40 (0.225 ± 0.016)	2.79 ± 0.30 (0.11 ± 0.012)	1.50 (0.06), 2.00 (0.08), 2.54 (0.10), 3.20 (0.126)	0.50 – 0.80 (0.020 – 0.030)	≥4 (≥0.0158)
2215	SYX/UYX	5.70 ± 0.40 (0.225 ± 0.016)	3.81 ± 0.35 (0.35 ± 0.02)	2.00 (0.08), 2.54 (0.10), 2.80 (0.11)	0.50 – 0.80 (0.020 – 0.030)	≥4 (≥0.0158)
2220	SYX/UYX	5.70 ± 0.40 (0.225 ± 0.016)	5.00 ± 0.40 (0.197 ± 0.016)	2.00 (0.08), 2.54 (0.10)	0.25 – 0.80 (0.010 – 0.030)	≥4 (≥0.0158)
	S3X/U3X	5.70 ± 0.40 (0.225 ± 0.016)	5.00 ± 0.40 (0.197 ± 0.016)	2.54 (0.1), 2.80 (0.11), 3.50 (0.138), 4.50 (0.177)	0.25 – 1.00 (0.010 – 0.040)	≥4 (≥0.0158)

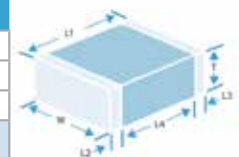

*Maximum part thickness will be one of the stated values, depending on capacitance requested. To find out the maximum thickness for a specific part, please use the Part Builder or Part Search application on the Knowles website to generate the component datasheet.



Enhanced 250Vac and 305Vac Safety Certified AC Capacitors



ORDERING INFORMATION – SYX/UYX FAMILY

1808	J	A25	0102	K	J	T	SYX
Chip Size	Termination	Voltage	Capacitance in Picofarads (pF)	Capacitance Tolerance	Dielectric Codes	Packaging	Suffix Code
1808 1812 2211 2215 2220	J = Nickel barrier (100% matte tin plating). RoHS compliant. Lead free.* Y = FlexiCap™ termination base with nickel barrier (100% matte tin plating). RoHS compliant.	A25 = 250Vac	First digit is 0. Second and third digits are significant figures of capacitance code. The fourth digit is number of zeros following. Example: 0102 = 1nF	<10pF B = ±0.10pF C = ±0.25pF D = ±0.50pF ≥10pF F = ±1% G = ±2% J = ±5% K = ±10% M = ±20%	K = COG/NP0 (1B) to AEC-Q200 S = X7R (2R1) to AEC-Q200 G = COG/NP0 (1B) J = X7R (2R1)	T = 178mm (7") reel R = 330mm (13") reel B = Bulk pack – tubs or tray	SYX = Y2 (250Vac)/ X1 (305Vac) Marked + Approved UYX = Unmarked parts in accordance with above but not certified

Notes: Blue Background = AEC-Q200. *J termination is available for dielectric codes K, G and J only.

2nd Suffix code "B92" will be used for range with AC DWV 2000Vac, please refer to individual datasheets on website for product specifications.

ORDERING INFORMATION – SYS/UYS FAMILY

1808	J	A25	0102	G	J	T	SYS
Chip Size	Termination	Voltage	Capacitance in Picofarads (pF)	Capacitance Tolerance	Dielectric Codes	Packaging	Suffix Code
1808 1812	J = Nickel barrier (100% matte tin plating). RoHS compliant. Lead free.* Y = FlexiCap™ termination base with nickel barrier (100% matte tin plating). RoHS compliant.	A25 = 250Vac	First digit is 0. Second and third digits are significant figures of capacitance code. The fourth digit is number of zeros following. Example: 0102 = 1nF	<10pF B = ±0.10pF C = ±0.25pF D = ±0.50pF ≥10pF F = ±1% G = ±2% J = ±5% K = ±10% M = ±20%	K = COG/NP0 (1B) to AEC-Q200 S = X7R (2R1) to AEC-Q200 G = COG/NP0 (1B) J = X7R (2R1)	T = 178mm (7") reel R = 330mm (13") reel B = Bulk pack – tubs or trays	SYS = Y2 (250Vac)/ X1 (305Vac) Marked + Approved UYS = Unmarked parts in accordance with above but not certified

Notes: Blue Background = AEC-Q200. *J termination is available for dielectric codes K, G and J only.

ORDERING INFORMATION – S3X/U3X FAMILY

2220	Y	A30	0563	K	S	T	S3X
Chip Size	Termination	Voltage	Capacitance in Picofarads (pF)	Capacitance Tolerance	Dielectric Codes	Packaging	Suffix Code
2220	J = Nickel barrier (100% matte tin plating). RoHS compliant. Lead free.* Y = FlexiCap™ termination base with nickel barrier (100% matte tin plating). RoHS compliant.	A30 = 305Vac	First digit is 0. Second and third digits are significant figures of capacitance code. The fourth digit is number of zeros following. Example: 0563 = 56nF	J = ±5% K = ±10% M = ±20%	S = X7R (2R1) to AEC-Q200 J = X7R (2R1)	T = 178mm (7") reel R = 330mm (13") reel B = Bulk pack – tubs or trays	S3X = X2 (305Vac) Marked + Approved U3X = Unmarked parts in accordance with above but not certified

Notes: Blue Background = AEC-Q200. *J termination is available for dielectric code J only.

ORDERING INFORMATION – S2X/U2X FAMILY

1808	J	A25	0102	G	J	T	S2X
Chip Size	Termination	Voltage	Capacitance in Picofarads (pF)	Capacitance Tolerance	Dielectric Codes	Packaging	Suffix Code
1808	J = Nickel barrier (100% matte tin plating). RoHS compliant. Lead free. Y = FlexiCap™ termination base with nickel barrier (100% matte tin plating). RoHS compliant.	A25 = 250Vac	First digit is 0. Second and third digits are significant figures of capacitance code. The fourth digit is number of zeros following. Example: 0102 = 1nF	<10pF B = ±0.10pF C = ±0.25pF D = ±0.50pF ≥10pF F = ±1% G = ±2% J = ±5% K = ±10% M = ±20%	K = COG/NP0 (1B) to AEC-Q200 G = COG/NP0 (1B)	T = 178mm (7") reel R = 330mm (13") reel B = Bulk pack – tubs or trays	S2X = X2 (250Vac) Marked + Approved U2X = Unmarked parts in accordance with above but not certified

Notes: Blue Background = AEC-Q200.



Non-Magnetic Capacitors — High Q, COG/NP0, X5R and X7R — 16V to 7.2kV

MLC capacitors with silver/palladium (Ag/Pd) terminations have often been used in medical applications where non-magnetic components are required, for example in MRI equipment — however, conventional nickel barrier terminations are not suitable due to their magnetic properties. In addition, RoHS requirement to use lead-free solders would cause an increase in soldering temperatures and cause solder leaching problems for the Ag/Pd termination. This has meant alternatives have had to be found and one solution is to use a copper barrier instead of a nickel barrier, with a tin finish on top. This non-magnetic termination is offered with selected non-magnetic COG/NP0, High Q, X5R and X7R dielectrics, providing a fully non-magnetic component ($\mu_r = 1.0000$).

To meet high temperature 260°C soldering reflow profiles as detailed in J-STD-020, COG/NP0 dielectrics are supplied with sintered termination for optimized HighQ/low ESR performance, while X5R and X7R dielectrics are supplied with our FlexiCap™ termination to minimize risk of mechanical cracking.

Available in chip or ribbon leaded format for certain case sizes (consult sales office).

'H' range BME parts are Ni free but have a small amount of residual magnetism. Testing in application may be advised.

HIGH Q, COG/NP0 (PME Q RANGE) — MINIMUM/MAXIMUM CAPACITANCE VALUES

Chip Size	0402	0603	0505	0805	1206	1210	1808	1812	2220
Min Cap	0.2pF	0.2pF	0.2pF	0.2pF	0.5pF	0.3pF	1.0pF	1.0pF	2.0pF
50V/63V	22pF	100pF	220pF	470pF	1.5nF	-	-	-	-
100V	15pF	100pF	220pF	330pF	1.0nF	2.2nF	2.2nF	4.7nF	10nF
150V	10pF	82pF	220pF	220pF	680pF	1.5nF	1.5nF	3.3nF	6.8nF
200V/250V	6.8pF	68pF	100pF	150pF	470pF	1.0nF	1.0nF	2.2nF	4.7nF
300V	-	27pF	47pF	120pF	390pF	820pF	820pF	1.8nF	3.9nF
500V	-	-	-	68pF	270pF	680pF	680pF	1.5nF	3.3nF
630V	Min Capacitance Tolerance			-	150pF	390pF	390pF	1.0nF	2.2nF
1000V	±0.05pF (<4.7pF)			-	82pF	220pF	220pF	680pF	1.5nF
2000V	0.1pF (≥4.7pF & <10pF)			-	18pF	68pF	68pF	150pF	470pF
3000V	±1% (≥10pF)			-	-	-	-	68pF	150pF

HIGH Q, COG/NP0 (BME H RANGE) — MINIMUM/MAXIMUM CAPACITANCE VALUES

Chip Size	0402	0505	0603	0805	1206	1210	1808
Min Cap	0.2pF	0.3pF	0.2pF	0.2pF	0.5pF	0.3pF	1.0pF
50V/63V	100pF	1.0nF	470pF	1.5nF	6.8nF	15nF	15nF
100V	100pF	560pF	470pF	1.0nF	2.7nF	4.7nF	4.7nF
150V	33pF	270pF	150pF	1.0nF	2.2nF	4.7nF	4.7nF
200V/250V	33pF	270pF	150pF	820pF	2.2nF	4.7nF	4.7nF
300V	-	240pF	150pF	430pF	1.5nF	1.8nF	1.8nF
500V	-	240pF	150pF	430pF	1.5nF	1.8nF	1.8nF
630V	Min Capacitance Tolerance			47pF	560pF	820pF	820pF
1000V	±0.05pF (<4.7pF)			47pF	560pF	820pF	820pF
2000V	0.1pF (≥4.7pF & <10pF)			-	100pF	270pF	390pF
3000V	±1% (≥10pF)			-	-	-	-

X7R/X5R — MINIMUM/MAXIMUM CAPACITANCE VALUES

Dielectric	Chip Size	0402	0603	0805	1206	1210	1808	1812	2220	2225
		Min Cap	47pF	100pF	330pF	680pF	1.5nF	2.2nF	3.3nF	6.8nF
X5R	16V	22nF	100nF	330nF	1.0μF	1.5μF	1.5μF	3.3μF	5.6μF	6.8μF
	25V	15nF	100nF	330nF	1.0μF	1.2μF	1.2μF	2.2μF	4.7μF	5.6μF
	50V/63V	10nF	100nF	150nF	470nF	1.0μF	680nF	1.5μF	3.3μF	3.3μF
X7R	100V	4.7nF	22nF	100nF	270nF	560nF	330nF	1.0μF	1.5μF	1.5μF
	200V/250V	680pF	5.6nF	27nF	100nF	220nF	180nF	470nF	1.0μF	1.0μF
	500V	-	1.5nF	8.2nF	33nF	100nF	100nF	270nF	560nF	680nF
	630V	-	-	4.7nF	10nF	27nF	33nF	150nF	330nF	390nF
	1000V	-	-	3.3nF	4.7nF	15nF	18nF	56nF	120nF	150nF
	1200V	Min Capacitance Tolerance			3.3nF	10nF	10nF	33nF	82nF	100nF
	1500V	±5%			2.7nF	6.8nF	6.8nF	22nF	47nF	68nF
	2000V				2.2nF	4.7nF	4.7nF	10nF	27nF	33nF

HIGH Q, COG/NP0 HIGH POWER RF CAPACITORS — MINIMUM/MAXIMUM CAPACITANCE VALUES

A range of ultra-low loss High Q ceramic capacitors with COG/NP0 characteristics suitable for high power applications where minimal power loss and very low self-heating is demanded.

Common applications include MRI body coils and wireless charging systems operating in the kHz and MHz frequencies.

Available in chip or ribbon leaded format.

Chip Size	0505		1111*				2225		4040		7676	
	Min	Q Max	Min	H Max	Min	Q Max	Min	Q Max	Min	Q Max	Min	Q Max
100V	-	-	2.0nF	4.7nF	1.6nF	2.2nF	-	-	-	-	-	-
150V	110pF	220pF	2.0nF	4.7nF	1.1nF	1.5nF	-	-	-	-	-	-
200V	-	-	2.0nF	4.7nF	-	-	6.2nF	10nF	16nF	27nF	-	-
250V	51pF	100pF	2.0nF	4.7nF	750pF	1.0nF	6.2nF	10nF	16nF	27nF	-	-
300V	0.2pF	47pF	910pF	1.8nF	620pF	680pF	-	-	-	-	-	-
500V	-	-	910pF	1.8nF	510pF	560pF	5.1nF	5.6nF	13nF	15nF	-	-
630V	-	-	910pF	1.8nF	240pF	470pF	3.6nF	4.7nF	11nF	12nF	-	-
1kV	-	-	910pF	1.8nF	110pF	220pF	1.1nF	3.3nF	5.6nF	10nF	-	-
1.5kV	-	-	430pF	820pF	75pF	100pF	-	-	-	-	-	-
2kV	-	-	1.0pF	390pF	0.4pF	68pF	510pF	1.0nF	1.6nF	5.1nF	-	-
3kV	-	-	-	-	-	-	110pF	470pF	910pF	1.5nF	5.6nF	10nF
3.6kV				-	-	-	1pF	47pF/100pF	-	-	-	-
4kV				-	-	-	-	-	620pF	820pF	-	-
5kV				-	-	-	-	-	360pF	560pF	1.0nF	5.1nF
6kV				-	-	-	-	-	160pF	330pF	-	-
7.0kV/7.2kV				-	-	-	-	-	1pF	56pF/150pF	-	-

*Case size 1111 has thickness 2.0 ± 0.2mm (0.08 ± 0.008")

Non-Magnetic Capacitors — High Q, COG/NP0, X5R and X7R — 16V to 7.2kV

RIBBON LEADED Silver plated copper ribbon attached with HMP solder — (MP greater than 260°C).

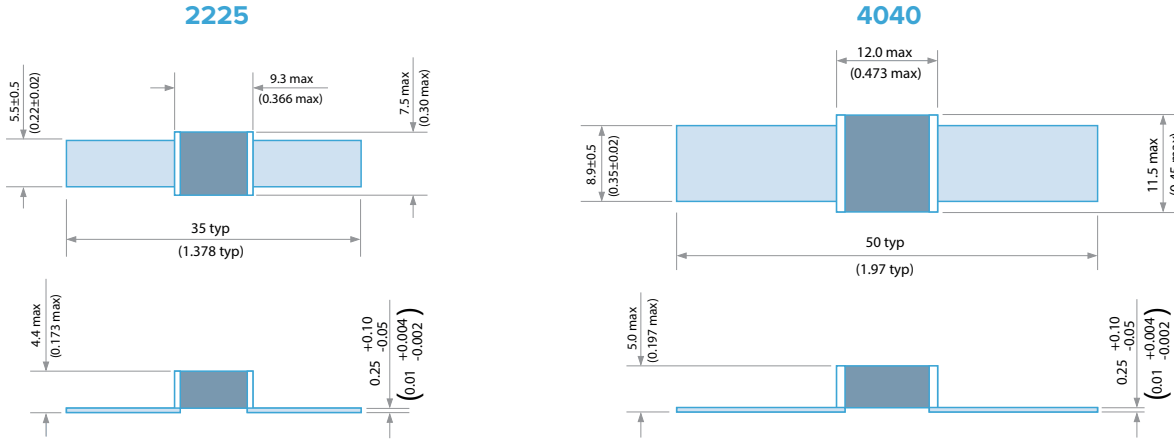

SURFACE MOUNT See page 23 for dimensions.

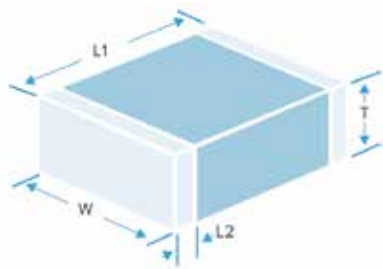

ORDERING INFORMATION — SYFER NON-MAGNETIC CAPACITORS

Chip size	Termination or Coating	Voltage	Capacitance in picofarads (pF)	Capacitance tolerance	Dielectric	Packing	Lead Options	Suffix code
1206	2	500	0223	J	Q	T	-	-
4040	2	7K0	0470	G	Q	B	-	AF9
2225	B	3K0	6P80	G	Q	B	R	W221
0402	Termination (Chip) 2 = Sintered silver with copper barrier	050 = 50V 100 = 100V	<10pF Insert a P for the decimal point, e.g., 2P20 = 2.2pF. >10pF. 1st digit is 0. 2nd and 3rd digits are significant figures of capacitance code. The 4th digit is number of zeros following e.g., 0470 = 47pF 0512 = 5100pF Values <1pF in 0.1pF steps, above this values are E24 series	<4.7pF H = ±0.05pF B = ±0.1pF C = ±0.25pF D = ±0.5pF ≥4.7pF ~ <10pF B = ±0.1pF C = ±0.25pF D = ±0.5pF ≥10pF F = ±1% G = ±2% J = ±5% K = ±10% M = ±20%	Q = COG - Hi Q/Low ESR (PME) H = COG - Hi Q/Low ESR (BME) P = X5R X = X7R (2R1)	T = 178mm (7") reel R = 330mm (13") reel B = Bulk pack — tubs or trays	R = Ribbon leaded Blank = SM chip	W221 = Leaded W211 = Leaded marked AF9 = SM standard chip AF9LM = SM marked standard chip
0603	3 = FlexiCap™ with copper barrier	2K0 = 2kV 3K0 = 3kV						
0505	4 = Sintered silver with copper barrier	4K0 = 4kV 5K0 = 5kV						
0805	5 = FlexiCap™ base with copper barrier	6K0 = 6kV 7K0 = 7kV						
1206	F = Palladium silver							
1111	Coating (Ribbon Leaded) B = Uncoated							
1210	V = Coated with modified silicone laquer							
1808								
1812								
2220								
2225								
4040								
7676								

Note: Not all options in the above table are available for all parts. To identify the required part number, use the Part Builder application on the Knowles website.



Non-Magnetic Capacitors, High Power RF — Porcelain High Q

Made from highly stable, low loss dielectric formulations, these traditional porcelain MLCs are known for their high RF power handling capability. Available in all industry common case sizes. The special silver-palladium termination and the proprietary ceramic formulations guarantee consistent non-magnetic performance. All MLCs in these series are RoHS compliant. Chips are available either with standard termination or can be fitted with ribbon leads, depending on your application.



DESCRIPTION

- Porcelain Capacitors • Zero TC • Low Noise • Low ESR, High Q
- High Self-Resonance • Established Reliability
- Capacitance Range 0.1pF to 5.1nF

FUNCTIONAL APPLICATIONS

- Impedance Matching • DC Blocking • Bypass • Coupling
- Tuning and Feedback

HIGH POWER RF CAPACITORS — CF AND AH MATERIALS — MINIMUM/MAXIMUM CAPACITANCE VALUES — see ordering information

Chip Size	C11 0505		C17 1111		C18 1111		C22 2225		C40 3838	
	Min.	Max.	Min.	Max.	Min.	Max.	Min.	Max.	Min.	Max.
50V	-	-	680pF	1nF	680pF	1.0nF	-	-	-	-
100V	-	-	510pF	620pF	510pF	620pF	-	-	-	-
200V	36pF	100pF	220pF	470pF	220pF	470pF	-	-	-	-
250V	0.3pF	33pF	-	-	-	-	-	-	-	-
300V	-	-	-	-	-	-	2.0nF	2.7nF	-	-
500V	-	-	110pF	200pF	-	-	1.3nF	1.8nF	2.4nF	5.1nF
1kV	-	-	0.3pF	100pF	110pF	200pF	510pF	1.2nF	750pF	2.2nF
1.5kV	-	-	-	-	-	-	300pF	470pF	-	-
2kV	-	-	-	-	0.3pF	100pF	-	-	-	-
2.5kV	-	-	-	-	-	-	0.3pF	270pF	430pF	680pF
3.6kV	-	-	-	-	-	-	-	-	110pF	390pF
7.2kV	-	-	-	-	-	-	-	-	0.3pF	100pF

Note: Special capacitance values available upon request.

ORDERING INFORMATION — NON-MAGNETIC CAPACITORS (PORCELAIN HIGH Q)

C17	CF	470	J	7	W	A	X	O	B
Case size	Dielectric	Capacitance	Tolerance	Voltage	Termination	Lead Option	Test Level	Marking	Packaging
C11 0505 C17 1111 C18 1111 C22 2225 C40 3838	AH +90±20ppm/°C CF 0±15ppm/°C	0R3 0.3pF 100 10pF 101 100pF 102 1000pF	A ±0.05pF B ±0.1pF C ±0.25pF D ±0.5pF F ±1% G ±2% J ±5% K ±10%	5 50V 1 100V 6 200V 9 250V 3 300V 4 500V 7 1kV A 1.5kV G 2kV B 2.5kV D 3.6kV H 7.2kV	W Ag/Cu/Sn P Pd/Ag M Poly/Cu/Sn	A Axial Ribbon N SM Chip	X Commercial or Industrial Y Reduced Visual A MIL-PRF-55681 Group A C MIL-PRF-55681 Group C	O No marking 1 Single-side marked 2 Double-side marked 3 Large single-side marked 4 Large double-side marked 5 Vertical edge marked 9 Customer Specified	B Bulk P Plastic Box T 7" Reel Horizontal Orientation

Note: *Available in chip or ribbon leaded format.

REELED QUANTITIES

Chip Size	0402	0505	0603	0805	1206	1111/1210	1808	1812	2220	2225
7" Reel	10,000	2,500	4,000	3,000	2,500	1,000/2,000	1,500	500	500	500
13" Reel	13" reel quantities available on request						6,000	2,000	2,000	2,000

Note: Other capacitance values may become available; please contact the Sales Office if you need values other than those shown in the above tables. For dimensions and soldering information, visit knowlescapacitors.com.

Non-Magnetic Capacitors, High Power RF — Porcelain High Q

TYPICAL PERFORMANCE DATA —
CHIP SIZE 0805 HIGH Q

TYPICAL PERFORMANCE DATA —
CHIP SIZE 1111 HIGH Q

ESR vs. Frequency

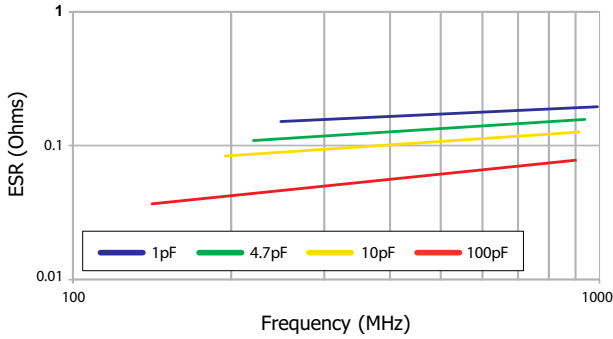

ESR vs. Frequency

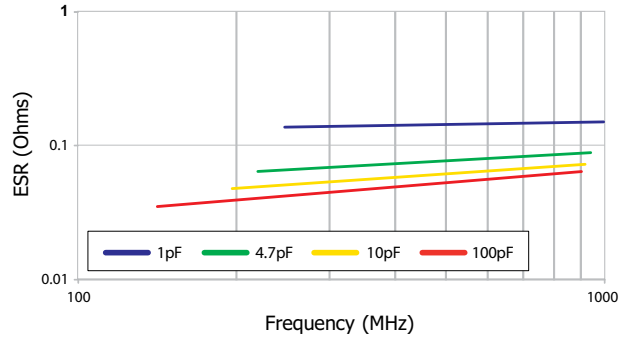

Q vs. Capacitance

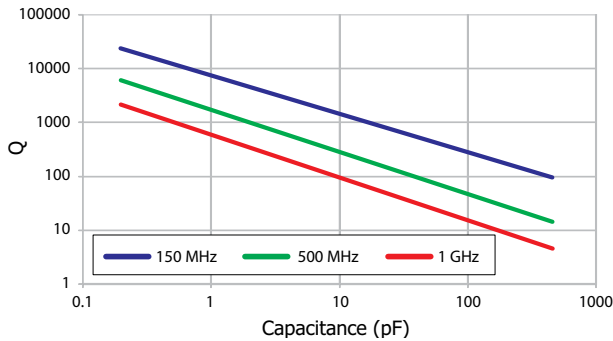

Q vs. Capacitance

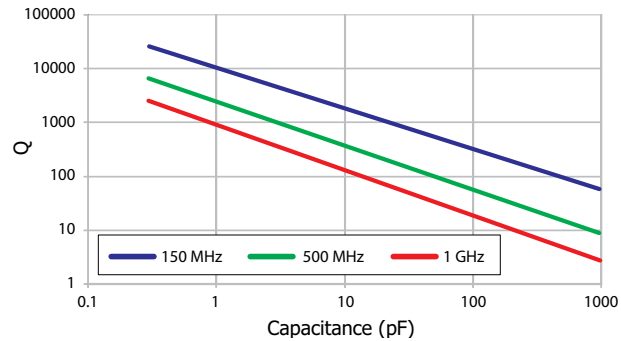

Resonant Frequency vs. Capacitance

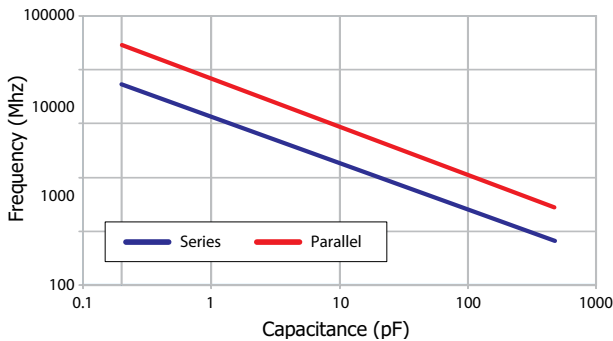

Resonant Frequency vs. Capacitance

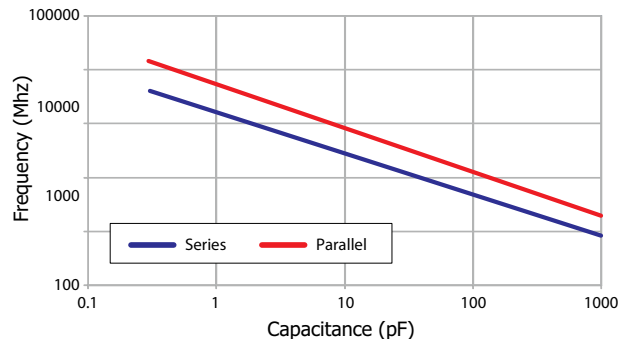

Typical ESR vs. Frequency

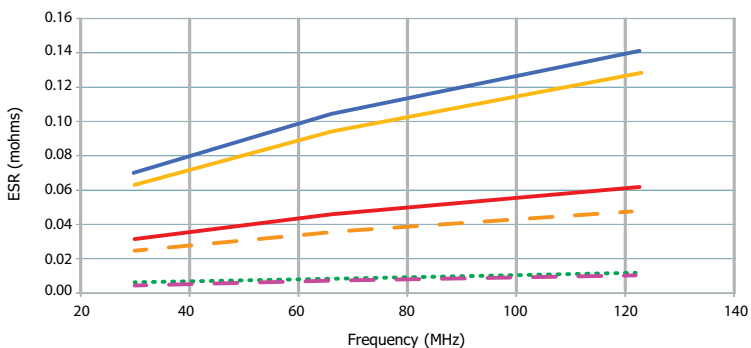

- 4040 56pF
- 4040 18pF
- ... 2225 2.2nF
- 2225 39pF
- 2225 10pF
- 4040 5.1nF

ESR MEASUREMENT

All ESR figures are measured using a VNA and 2m copper resonant tube and extrapolating to 30MHz by ratio. Measured data can be supplied on request. Measurement of ESR can vary with test method and components should only be compared when tested back to back on the same equipment under controlled conditions.



115Vac 400Hz Capacitors

115VAC 400HZ CAPACITORS FOR AEROSPACE APPLICATIONS

Knowles has conducted reliability testing on standard surface mount ceramic capacitors in order to ensure their performance at 115Vac 400Hz and the associated voltage and frequency transients required by MIL-STD-704. Self-heating will occur due to losses in the capacitor, but has been measured at less than 25°C rise with neutral mounting conditions at room temperature.



115VAC 400HZ CAPACITORS — MINIMUM/MAXIMUM CAPACITANCE VALUES

	0805	1206	1210	1808	1812	2220
Dielectric	Maximum capacitance values					
COG/NPO	1pF-330pF	1pF-1.5nF	3.9pF-3.9nF	4.7pF-3.9nF	10pF-10nF	10pF-15nF
X7R	100pF-4.7nF	100pF-18nF	100pF-39nF	100pF-39nF	150pF-82nF	220pF-100nF

ORDERING INFORMATION — 115VAC 400HZ CAPACITORS

1206	Y	A12	0103	J	X	T
Chip size	Termination	Voltage	Capacitance in picofarads (pF)	Capacitance tolerance	Dielectric codes	Packaging
0805 1206 1210 1808 1812 2220	<p>Y = FlexiCap™ termination base with nickel barrier (100% matte tin plating). RoHS compliant.</p> <p>H = FlexiCap™ termination base with nickel barrier (Tin/lead plating with min. 10% lead). Not RoHS compliant.</p> <p>J = Nickel barrier (100% matte tin plating). RoHS compliant. Lead free.</p> <p>A = Nickel barrier (Tin/lead plating with min. 10% lead). Not RoHS compliant.</p>	A12 = 115Vac	<p>First digit is zero. Second and third digits are significant figures of capacitance code. The fourth digit is number of zeros following.</p> <p>Example: 0103 = 10nF</p>	<p><4.7pF H = ±0.05pF B = ±0.10pF C = ±0.25pF D = ±0.50pF</p> <p>≥4.7pF & <10pF B = ±0.10pF C = ±0.25pF D = ±0.50pF</p> <p>≥10pF F = ±1% G = ±2% J = ±5% K = ±10% M = ±20%</p>	<p>C = COG/NPO X = X7R</p>	<p>T = 178mm (7") reel R = 330mm (13") reel B = Bulk pack — tubs or trays</p>



Medical Grade Capacitors (MD Series)

Medical implantable devices require High Reliability Components to perform all the time, every time! To achieve this performance, Knowles screens every component. For medical implantable devices, screening is generally performed by following these two long-standing military specifications (MIL-SPECS) for reliability – MIL-PRF-55681 (Group A) and MIL-PRF-123 (Group A). Putting parts through our testing and screening processes means you can be confident that our components will produce the level of reliability and safety necessary for being on the circuit boards of your life-critical implantable medical devices.



- **COG: -55°C to +125°C, ±30PPM/°C, 0201-1210 Sizes**
- **X7R: -55°C to +125°C, ±15%, 0201-1210 Sizes**
- **X5R: -55°C to +85°C, ±15%, 0201-1210 Sizes**

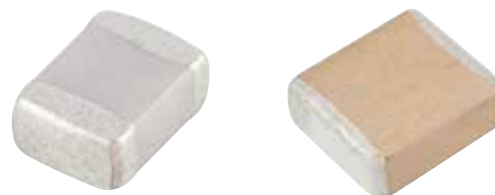

Series	Chip Size	Dielectric	Capacitance	Tolerance	Voltage VDC	Termination	High Reliability Testing*	Packing Option	-	Screening
MD	0201 0402 0603 0805 1206 1210	N = COG/ NPO (PME)	Value in Picofarads	Cap Values <10pF B = ± 0.1pF C = ± 0.25pF D = ± 0.5pF	Two significant Figures, Followed by Number of Zeroes: 101 = 100V 250 = 25V 6R3 = 6.3V	N = Nickel Barrier 100% Tin (RoHS) Y = Nickel Barrier 90% Tin/Lead (4% min. Leads) NG = Nickel Barrier Gold Flash (RoHS) P = Palladium Silver	H	T = Tape & Reel W = Waffle Pack None = Bulk		Bx = B-Testing per MIL-PRF-55681 Sx = S-Testing per MIL-PRF-123
	Larger case sizes available upon request	B = X7R (PME) BB = X7R (BME)	Two Significant Figures, Followed by Number of Zeros: R = Decimal Point 1R0 = 1pF 102 = 1,000pF 103 = 10,000pF 104 = 100,000pF	J = ± 5%* K = ± 10% M = ± 20% *Only for B Dielectric						
		BW = X5R (BME)		K = ± 10% M = ± 20%						

P = Precious Metal Electrode (PME) B = Base Metal Electrode (BME)

For more information on High Reliability Testing, please refer to page 14 of the Knowles MLCC Catalog



Medical Implatable Capacitance Range

COG: -55°C to +125°C, ±30PPM/°C, 0201-1210 Sizes



ORDERING INFORMATION

MD	0603 Size	N Dielectric	102 Capacitance	J Tolerance	500 Voltage VDCW	N Termination	H Hi-Rel Testing	T Packing Option	BA Screening
Medical Grade	Size	N = COG/ NPO (PME) BN = COG/ NPO (BME)	Value in PicoFarads Two Significant Figures, Followed by Number of Zeros: 102 = 1,000pF	B = ± 0.1pF* C = ± 0.25pF* D = ± 0.5pF* F = ± 1% G = ± 2% J = ± 5% K = ± 10%	Two significant Figures, Followed by Number of Zeros: 500 = 50V 250 = 25V 6R3 = 6.3V	N = Nickel Barrier 100% Tin (RoHS) Y = Nickel Barrier 90% Tin/Lead (4% min. Lead)	H	T = Tape & Reel W = Waffle Pack None = Bulk	B _x = B-Testing per MIL-PRF-55681 S _x = S-Testing per MIL-PRF-123

*<10 pF

EIA Case Size		0201				0402				0603				0805				1206				1210											
Cap	Code	6.3V	10V	16V	25V	6.3V	10V	16V	25V	50V	100V	200V	6.3V	10V	16V	25V	50V	100V	200V	6.3V	10V	16V	25V	50V	100V	200V	6.3V	10V	16V	25V	50V	100V	200V
0.5-9.9pF	0R5-9R9	BN	BN	BN	BN	N	N	N	N	N	N	N	N	N	N	N	N	N	N	N	N	N	N	N	N	N	N	N	N	N	N	N	
10-82pF	100-820	BN	BN	BN	BN	N	N	N	N	N	N	N	N	N	N	N	N	N	N	N	N	N	N	N	N	N	N	N	N	N	N	N	
100pF	101	BN	BN	BN	BN	N	N	N	N	N	N	N	N	N	N	N	N	N	N	N	N	N	N	N	N	N	N	N	N	N	N	N	
120pF	121	BN	BN	BN	BN	N	N	N	N	N	N	N	N	N	N	N	N	N	N	N	N	N	N	N	N	N	N	N	N	N	N	N	
150pF	151	BN	BN	BN	BN	N	N	N	N	N	N	N	N	N	N	N	N	N	N	N	N	N	N	N	N	N	N	N	N	N	N	N	
180pF	181	BN	BN	BN	BN	N	N	N	N	N	N	N	N	N	N	N	N	N	N	N	N	N	N	N	N	N	N	N	N	N	N	N	
220pF	221	BN	BN	BN	BN	N	N	N	N	N	N	N	N	N	N	N	N	N	N	N	N	N	N	N	N	N	N	N	N	N	N	N	
270pF	271	BN	BN	BN	BN	BN	BN	BN	BN	N	N	N	N	N	N	N	N	N	N	N	N	N	N	N	N	N	N	N	N	N	N	N	
330pF	331	BN	BN	BN	BN	BN	BN	BN	BN	N	N	N	N	N	N	N	N	N	N	N	N	N	N	N	N	N	N	N	N	N	N	N	
390pF	391	BN	BN	BN	BN	BN	BN	BN	BN	N	N	N	N	N	N	N	N	N	N	N	N	N	N	N	N	N	N	N	N	N	N	N	
470pF	471	BN	BN	BN	BN	BN	BN	BN	BN	N	N	N	N	N	N	N	N	N	N	N	N	N	N	N	N	N	N	N	N	N	N	N	
560pF	561	BN	BN	BN	BN	BN	BN	BN	BN	N	N	N	N	N	N	N	N	N	N	N	N	N	N	N	N	N	N	N	N	N	N	N	
680pF	681	BN	BN	BN	BN	BN	BN	BN	BN	N	N	N	N	N	N	N	N	N	N	N	N	N	N	N	N	N	N	N	N	N	N	N	
820pF	821	BN	BN	BN	BN	BN	BN	BN	BN	N	N	N	N	N	N	N	N	N	N	N	N	N	N	N	N	N	N	N	N	N	N	N	
1nF	102	BN	BN	BN	BN	BN	BN	BN	BN	N	N	N	N	N	N	N	N	N	N	N	N	N	N	N	N	N	N	N	N	N	N	N	
1.2nF	122																																
1.5nF	152																																
1.8nF	182																																
2.2nF	222																																
2.7nF	272																																
3.3nF	332																																
3.9nF	392																																
4.7nF	472																																
5.6nF	562																																
6.8nF	682																																
8.2nF	822																																
10nF	103																																
12nF	123																																
15nF	153																																
18nF	183																																
22nF	223																																
33nF	333																																
47nF	473																																
82nF	823																																
100nF	104																																

N = Precious Metal Electrode (PME) BN = Base Metal Electrode (BME)



Medical Implatable Capacitance Range

X7R: -55°C to +125°C, ±15%, 0201-1210 Sizes



ORDERING INFORMATION

MD	0603 Size	B Dielectric	102 Capacitance	J Tolerance	500 Voltage VDCW	N Termination	H Hi-Rel Testing	T Packing Option	BA Screening
Medical Grade	Size	B = X7R (PME) BB = X7R (BME)	Value in PicoFarads Two Significant Figures, Followed by Number of Zeros: 102 = 1,000pF	J = ± 5% K = ± 10% M = ± 20%	Two significant Figures, Followed by Number of Zeros: 101 = 100V 250 = 25V 6R3 = 6.3V	N = Nickel Barrier 100% Tin (RoHS) Y = Nickel Barrier 90% Tin/Lead (4% min. Lead)	H	T = Tape & Reel W = Waffle Pack None = Bulk	B _X = B-Testing per MIL-PRF-55681 S _X = S-Testing per MIL-PRF-123

EIA Case Size		0201		0402				0603				0805				1206				1210												
Cap	Code	6.3V	10V	16V	6.3V	10V	16V	25V	50V	100V	200V	6.3V	10V	16V	25V	50V	100V	200V	6.3V	10V	16V	25V	50V	100V	200V	6.3V	10V	16V	25V	50V	100V	200V
150pF	151	BB	BB	BB	B	B	B	B	B	B	B	B	B	B	B	B	B	B	B	B	B	B	B	B	B	B	B	B	B	B	B	
220pF	221	BB	BB	BB	B	B	B	B	B	B	B	B	B	B	B	B	B	B	B	B	B	B	B	B	B	B	B	B	B	B	B	
330pF	331	BB	BB	BB	B	B	B	B	B	B	B	B	B	B	B	B	B	B	B	B	B	B	B	B	B	B	B	B	B	B	B	
470pF	471	BB	BB	BB	B	B	B	B	B	B	B	B	B	B	B	B	B	B	B	B	B	B	B	B	B	B	B	B	B	B	B	
680pF	681	BB	BB	BB	B	B	B	B	B	B	B	B	B	B	B	B	B	B	B	B	B	B	B	B	B	B	B	B	B	B	B	
1nF	102	BB	BB	BB	B	B	B	B	B	B	B	B	B	B	B	B	B	B	B	B	B	B	B	B	B	B	B	B	B	B	B	
1.5nF	152	BB	BB	BB	B	B	B	B	B	B	B	B	B	B	B	B	B	B	B	B	B	B	B	B	B	B	B	B	B	B	B	
2.2nF	222	BB	BB	BB	B	B	B	B	B	B	B	B	B	B	B	B	B	B	B	B	B	B	B	B	B	B	B	B	B	B	B	
3.3nF	332	BB	BB	BB	B	B	B	B	B	B	B	B	B	B	B	B	B	B	B	B	B	B	B	B	B	B	B	B	B	B	B	
4.7nF	472	BB	BB	BB	B	B	B	B	B	B	B	B	B	B	B	B	B	B	B	B	B	B	B	B	B	B	B	B	B	B	B	
6.8nF	682	BB	BB	BB	B	B	B	B	B	B	B	B	B	B	B	B	B	B	B	B	B	B	B	B	B	B	B	B	B	B	B	
10nF	103	BB	BB	BB	B	B	B	B	B	B	B	B	B	B	B	B	B	B	B	B	B	B	B	B	B	B	B	B	B	B	B	
12nF	123											B	B	B	B	B	B	B	B	B	B	B	B	B	B	B	B	B	B	B	B	
15nF	153				BB	BB	BB					B	B	B	B	B	B	B	B	B	B	B	B	B	B	B	B	B	B	B	B	
22nF	223	BB	BB		BB	BB	BB					B	B	B	B	B	B	B	B	B	B	B	B	B	B	B	B	B	B	B	B	
33nF	333				BB	BB	BB					B	B	B	B	B	B	B	B	B	B	B	B	B	B	B	B	B	B	B	B	
47nF	473				BB	BB	BB					B	B	B	B	B	B	B	B	B	B	B	B	B	B	B	B	B	B	B	B	
68nF	683											B	B	B	B	B	B	B	B	B	B	B	B	B	B	B	B	B	B	B	B	
100nF	104				BB	BB	BB	BB				B	B	B	B	B	B	B	B	B	B	B	B	B	B	B	B	B	B	B	B	
120nF	124											B	B	B					B	B	B	B	B	B	B	B	B	B	B	B	B	
150nF	154											B	B	B					B	B	B	B	B	B	B	B	B	B	B	B	B	
220nF	224				BB	BB						BB	BB	BB	BB				B	B	B	BB				B	B	B	B	B	B	
330nF	334																										B	B	B	B	B	B
470nF	474				BB							BB	BB	BB	BB				BB	BB	BB	BB				BB	BB	BB	BB		BB	
680nF	684																															
1µF	105											BB	BB	BB	BB				BB	BB	BB	BB				BB	BB	BB	BB	BB	BB	
1.5µF	155																															
2.2µF	225											BB	BB						BB	BB	BB					BB	BB	BB	BB	BB	BB	
3.3µF	335																															
4.7µF	475												BB	BB					BB	BB	BB					BB	BB	BB				
6.8µF	685																															
10µF	106												BB	BB					BB	BB	BB					BB	BB	BB				
15µF	156																															
22µF	226																															
33µF	336																															

B = Precious Metal Electrode (PME) BB = Base Metal Electrode (BME)



Medical Implatable Capacitance Range

X5R: -55°C to +85°C, ±15%, 0201-1210 Sizes



ORDERING INFORMATION

MD	0603 Size	BW Dielectric	102 Capacitance	K Tolerance	500 Voltage VDCW	N Termination	H Hi-Rel Testing	T Packing Option	BA Screening
Medical Grade	Size	BW = X5R (BME)	Value in Picofarads Two Significant Figures, Followed by Number of Zeros: 102 = 1,000pF	K = ± 10% M = ± 20%	Two significant Figures, Followed by Number of Zeros: 500 = 50V 250 = 25V 6R3 = 6.3V	N = Nickel Barrier 100% Tin (RoHS) Y = Nickel Barrier 90% Tin/Lead (4% min. Lead)	H	T = Tape & Reel W = Waffle Pack None = Bulk	B _x = B-Testing per MIL-PRF-55681 S _x = S-Testing per MIL-PRF-123

EIA Case Size		0201				0402						0603						0805						1206						1210																							
Cap	Code	6.3V	10V	16V	25V	6.3V	10V	16V	25V	50V	100V	200V	6.3V	10V	16V	25V	50V	100V	200V	6.3V	10V	16V	25V	50V	100V	200V	6.3V	10V	16V	25V	50V	100V	200V	6.3V	10V	16V	25V	50V	100V	200V													
150pF	151	BW	BW	BW	BW	BW	BW	BW	BW	BW	BW	BW	BW	BW	BW	BW	BW	BW	BW	BW	BW	BW	BW	BW	BW	BW	BW	BW	BW	BW	BW	BW	BW	BW	BW	BW	BW	BW	BW	BW	BW	BW	BW	BW									
220pF	221	BW	BW	BW	BW	BW	BW	BW	BW	BW	BW	BW	BW	BW	BW	BW	BW	BW	BW	BW	BW	BW	BW	BW	BW	BW	BW	BW	BW	BW	BW	BW	BW	BW	BW	BW	BW	BW	BW	BW	BW	BW	BW	BW	BW	BW	BW						
330pF	331	BW	BW	BW	BW	BW	BW	BW	BW	BW	BW	BW	BW	BW	BW	BW	BW	BW	BW	BW	BW	BW	BW	BW	BW	BW	BW	BW	BW	BW	BW	BW	BW	BW	BW	BW	BW	BW	BW	BW	BW	BW	BW	BW	BW	BW	BW	BW					
470pF	471	BW	BW	BW	BW	BW	BW	BW	BW	BW	BW	BW	BW	BW	BW	BW	BW	BW	BW	BW	BW	BW	BW	BW	BW	BW	BW	BW	BW	BW	BW	BW	BW	BW	BW	BW	BW	BW	BW	BW	BW	BW	BW	BW	BW	BW	BW	BW					
680pF	681	BW	BW	BW	BW	BW	BW	BW	BW	BW	BW	BW	BW	BW	BW	BW	BW	BW	BW	BW	BW	BW	BW	BW	BW	BW	BW	BW	BW	BW	BW	BW	BW	BW	BW	BW	BW	BW	BW	BW	BW	BW	BW	BW	BW	BW	BW	BW					
1nF	102	BW	BW	BW	BW	BW	BW	BW	BW	BW	BW	BW	BW	BW	BW	BW	BW	BW	BW	BW	BW	BW	BW	BW	BW	BW	BW	BW	BW	BW	BW	BW	BW	BW	BW	BW	BW	BW	BW	BW	BW	BW	BW	BW	BW	BW	BW	BW					
1.5nF	152	BW	BW	BW	BW	BW	BW	BW	BW	BW	BW	BW	BW	BW	BW	BW	BW	BW	BW	BW	BW	BW	BW	BW	BW	BW	BW	BW	BW	BW	BW	BW	BW	BW	BW	BW	BW	BW	BW	BW	BW	BW	BW	BW	BW	BW	BW	BW	BW				
2.2nF	222	BW	BW	BW	BW	BW	BW	BW	BW	BW	BW	BW	BW	BW	BW	BW	BW	BW	BW	BW	BW	BW	BW	BW	BW	BW	BW	BW	BW	BW	BW	BW	BW	BW	BW	BW	BW	BW	BW	BW	BW	BW	BW	BW	BW	BW	BW	BW	BW				
3.3nF	332	BW	BW	BW	BW	BW	BW	BW	BW	BW	BW	BW	BW	BW	BW	BW	BW	BW	BW	BW	BW	BW	BW	BW	BW	BW	BW	BW	BW	BW	BW	BW	BW	BW	BW	BW	BW	BW	BW	BW	BW	BW	BW	BW	BW	BW	BW	BW	BW	BW			
4.7nF	472	BW	BW	BW	BW	BW	BW	BW	BW	BW	BW	BW	BW	BW	BW	BW	BW	BW	BW	BW	BW	BW	BW	BW	BW	BW	BW	BW	BW	BW	BW	BW	BW	BW	BW	BW	BW	BW	BW	BW	BW	BW	BW	BW	BW	BW	BW	BW	BW	BW			
6.8nF	682	BW	BW	BW	BW	BW	BW	BW	BW	BW	BW	BW	BW	BW	BW	BW	BW	BW	BW	BW	BW	BW	BW	BW	BW	BW	BW	BW	BW	BW	BW	BW	BW	BW	BW	BW	BW	BW	BW	BW	BW	BW	BW	BW	BW	BW	BW	BW	BW	BW			
10nF	103	BW	BW	BW	BW	BW	BW	BW	BW	BW	BW	BW	BW	BW	BW	BW	BW	BW	BW	BW	BW	BW	BW	BW	BW	BW	BW	BW	BW	BW	BW	BW	BW	BW	BW	BW	BW	BW	BW	BW	BW	BW	BW	BW	BW	BW	BW	BW	BW	BW			
12nF	123												BW	BW	BW	BW	BW	BW	BW	BW	BW	BW	BW	BW	BW	BW	BW	BW	BW	BW	BW	BW	BW	BW	BW	BW	BW	BW	BW	BW	BW	BW	BW	BW	BW	BW	BW	BW	BW				
15nF	153					BW	BW	BW					BW	BW	BW	BW	BW	BW	BW	BW	BW	BW	BW	BW	BW	BW	BW	BW	BW	BW	BW	BW	BW	BW	BW	BW	BW	BW	BW	BW	BW	BW	BW	BW	BW	BW	BW	BW	BW	BW			
22nF	223	BW	BW	BW		BW	BW	BW					BW	BW	BW	BW	BW	BW	BW	BW	BW	BW	BW	BW	BW	BW	BW	BW	BW	BW	BW	BW	BW	BW	BW	BW	BW	BW	BW	BW	BW	BW	BW	BW	BW	BW	BW	BW	BW	BW			
33nF	333	BW	BW			BW	BW	BW					BW	BW	BW	BW				BW	BW	BW	BW	BW	BW	BW	BW	BW	BW	BW	BW	BW	BW	BW	BW	BW	BW	BW	BW	BW	BW	BW	BW	BW	BW	BW	BW	BW	BW	BW			
47nF	473	BW	BW			BW	BW	BW					BW	BW	BW				BW	BW	BW	BW	BW	BW	BW	BW	BW	BW	BW	BW	BW	BW	BW	BW	BW	BW	BW	BW	BW	BW	BW	BW	BW	BW	BW	BW	BW	BW	BW	BW			
68nF	683	BW	BW			BW	BW						BW	BW	BW				BW	BW	BW	BW	BW	BW	BW	BW	BW	BW	BW	BW	BW	BW	BW	BW	BW	BW	BW	BW	BW	BW	BW	BW	BW	BW	BW	BW	BW	BW	BW	BW			
100nF	104	BW	BW			BW	BW	BW	BW				BW	BW	BW				BW	BW	BW	BW				BW	BW	BW	BW	BW	BW	BW	BW	BW	BW	BW	BW	BW	BW	BW	BW	BW	BW	BW	BW	BW	BW	BW	BW	BW			
120nF	124												BW	BW	BW				BW	BW	BW				BW	BW	BW	BW	BW	BW	BW	BW	BW	BW	BW	BW	BW	BW	BW	BW	BW	BW	BW	BW	BW	BW	BW	BW	BW	BW			
150nF	154												BW	BW	BW				BW	BW	BW				BW	BW	BW	BW	BW	BW	BW	BW	BW	BW	BW	BW	BW	BW	BW	BW	BW	BW	BW	BW	BW	BW	BW	BW	BW	BW			
220nF	224	BW	BW			BW	BW	BW	BW				BW	BW	BW	BW				BW	BW	BW	BW				BW	BW	BW	BW	BW	BW	BW	BW	BW	BW	BW	BW	BW	BW	BW	BW	BW	BW	BW	BW	BW	BW	BW	BW	BW		
330nF	334												BW	BW	BW				BW	BW	BW				BW	BW	BW																										
470nF	474	BW				BW	BW	BW					BW	BW	BW	BW				BW	BW	BW	BW				BW	BW	BW	BW																							
680nF	684												BW	BW	BW				BW	BW	BW				BW	BW	BW																										
1µF	105	BW				BW	BW	BW					BW	BW	BW	BW				BW	BW	BW	BW				BW	BW	BW	BW																							
1.5µF	155												BW	BW	BW				BW	BW	BW				BW	BW	BW																										
2.2µF	225					BW	BW						BW	BW	BW				BW	BW	BW				BW	BW	BW	BW																									
3.3µF	335												BW	BW					BW	BW					BW	BW																											
4.7µF	475					BW							BW	BW					BW	BW	BW				BW	BW	BW	BW																									
6.8µF	685												BW						BW						BW																												
10µF	106												BW						BW	BW					BW	BW	BW																										
15µF	156												BW						BW	BW					BW	BW	BW																										
22µF	226												BW						BW						BW	BW																											
33µF	336												BW						BW	BW					BW	BW																											

BW = Base Metal Electrode (BME)



Medical Grade Capacitors - Screening Options

Screening options are tailored for selectable-combination testing. This reduces or eliminates costs associated with the development and maintenance of device-specific documentation packages while maintaining performance integrity.

SCREENING	REQUIREMENTS AND CONDITIONS	SUFFIX CODE OPTIONS*							
		Engineering Model	MIL-PRF-55681			MIL-PRF-123			
		-EM	-BA	-BB	-BC	-SA	-SB	-SC	-SD
Ultrasonic inspection (CSAM)	MIL-PRF-123, MIL-STD-202-220, and EIA-469	NR	NR	NR	NR	NR	✓	✓	✓
Thermal shock	MIL-PRF-123, MIL-STD-202-107, 20 cycles	NR	NR	NR	NR	✓	✓	✓	✓
Voltage conditioning	MIL-PRF-123, 168-264 hours, 3(0.1)% PDA, max rated temp.	NR	NR	NR	NR	✓	✓	✓	✓
Voltage conditioning	MIL-PRF-55681, 100 hours 8% PDA, max rated temp	NR	✓	✓	✓	NR	NR	NR	NR
Hot Insulation Resistance	MIL-PRF-123, 125C (X5R 85C), 100%.	NR	NR	NR	NR	✓	✓	✓	✓
Hot Insulation Resistance	MIL-PRF-55681, 125C (X5R 85C), (sample quantity based on lot size**)	NR	✓	✓	✓	NR	NR	NR	NR
Insulation Resistance 25C	MIL-PRF-123, MIL-PRF-55681, MIL-STD-202-302, 100%	✓	✓	✓	✓	✓	✓	✓	✓
Dielectric Withstanding Voltage	MIL-PRF-123, MIL-PRF-55681, MIL-STD-202-301, 100%	✓	✓	✓	✓	✓	✓	✓	✓
Capacitance	MIL-PRF-123, MIL-PRF-55681, MIL-STD-202-305, 100%	✓	✓	✓	✓	✓	✓	✓	✓
Dissipation Factor	MIL-PRF-123, MIL-PRF-55681, 100%	✓	✓	✓	✓	✓	✓	✓	✓
Solderability	MIL-STD-202-208, 85%, sample 13(0)	✓	✓	✓	✓	✓	✓	✓	✓
Visual Inspection	MIL-PRF-123, MIL-PRF-55681, 100%	✓	✓	✓	✓	✓	✓	✓	✓
Destructive physical analysis	MIL-PRF-123, EIA-469, 5(0)	NR	NR	NR	NR	✓	✓	✓	✓
Life test	MIL-PRF-123, MIL-STD-202-108, 1000 hours, (sample quantity based on lot size**)	NR	NR	NR	NR	NR	NR	✓	✓
Life test	MIL-PRF-55681, MIL-STD-202-108, 2000 hours, sample 25(1)	NR	NR	✓	✓	NR	NR	NR	NR
Humidity, steady state, low voltage	MIL-PRF-123, MIL-PRF-55681, MIL-STD-202-103, 12(0)	NR	NR	✓	✓	NR	NR	✓	✓
Voltage Temperature Limits	MIL-PRF-123, MIL-PRF-55681, 12(0)	NR	NR	✓	✓	NR	NR	✓	✓
Moisture Resistance	MIL-PRF-123, MIL-PRF-55681, MIL-STD-202-106, 12(1)	NR	NR	NR	✓	NR	NR	NR	✓
Resistance to Soldering Heat	MIL-PRF-123, MIL-PRF-55681, MIL-STD-202-210, 12(0)	NR	NR	NR	✓	NR	NR	NR	✓
Board Flex	MIL-PRF-123, MIL-PRF-55681, MIL-STD-202-218, 12(0)	NR	NR	NR	✓	NR	NR	NR	✓
Shear	MIL-PRF-123, MIL-PRF-55681, MIL-STD-202-219, 12(0)	NR	NR	NR	✓	NR	NR	NR	✓

-EM = Engineering Model

-BA = MIL-PRF-55681 Group A

-BB = BA + Life, Humidity, Steady State, Low Voltage, and Voltage-Temperature Limits

-BC = MIL-PRF-55681 Group A and C

-SA = MIL-PRF-123 Group A

-SB = SA + CSAM

-SC = SB + Life, Humidity, Steady State, Low Voltage, and Voltage-Temperature Limits

-SD = CSAM + MIL-PRF-123 Group A, B, and C

* Screening options are defined by suffix code. There are two military based options for screening:

- **MIL-PRF-55681:** –Bx where the second character lists the various environmental – testing options.
- **MIL-PRF-123:** –Sx where the second character lists the various environmental-testing options.

✓ = Required

NR = Not Required

**Please contact Knowles for more information



X8R High Temperature Capacitors — up to 150°C



The X8R dielectric will operate from -55°C to +150°C, with a maximum capacitance change ±15% (without applied voltage).

The devices are available in sizes 0805 to 2225, with voltage ranges from 25V to 3kV and capacitance values from 100pF to 2.2µF.

The capacitors have been developed by Knowles Precision Devices to meet demand from various applications in the automotive and industrial markets and in other electronic equipment exposed to high temperatures. The increased use of electronics in automotive “under the hood” applications has created demand for this product range.

The X8R range incorporates a specially formulated termination with a nickel barrier finish that has been designed to enhance the mechanical performance of these SMD chip capacitors in harsh environments typically present in automotive applications.

X8R HIGH TEMPERATURE CAPACITORS — CAPACITANCE VALUES

X8R	0805	1206	1210	1808	1812	2220	2225
Max. Thickness	1.37mm	1.7mm	2.0mm	2.0mm	2.5mm	2.5mm	2.5mm
Min cap	100pF	100pF	100pF	100pF	150pF	220pF	330pF
Min cap	220pF	220pF	220pF	220pF	220pF	220pF	330pF
50V	47nF	150nF	330nF	330nF	680nF	1.2µF	2.2µF
100V	33nF	100nF	220nF	220nF	470nF	1µF	1.5µF
200/250V	15nF	68nF	150nF	150nF	330nF	680nF	1µF
500V	4.7nF	22nF	47nF	47nF	120nF	330nF	470nF
630V	2.2nF	10nF	33nF	33nF	68nF	180nF	220nF
1kV	1.5nF	3.3nF	6.8nF	6.8nF	27nF	68nF	82nF
1.2kV	-	2.2nF	5.6nF	5.6nF	15nF	47nF	56nF
1.5kV	-	1.5nF	3.3nF	3.3nF	10nF	27nF	33nF
2kV	-	680pF	1.5nF	1.5nF	5.6nF	15nF	22nF
2.5kV	-	-	-	1.2nF	3.3nF	10nF	12nF
3kV	-	-	-	820pF	2.7nF	5.6nF	6.8nF

Note: Blue background = AEC-Q200.

CAPACITANCE RANGE:

100pF to 2.2µF (0805 to 2225)

TEMPERATURE COEFFICIENT OF CAPACITANCE (TCC):

±15% from -55°C to +150°C

CAPACITANCE RANGE:

< 0.025

TERMINATION:

Nickel Barrier Tin Plated

INSULATION RESISTANCE (IR):

100G Ω or 1000secs (whichever is the less).

DIELECTRIC WITHSTAND VOLTAGE (DWV)

2.5 x rated voltage for 5±1 seconds, 50mA charging current maximum.

AGING RATE:

1% per decade (typical)

ORDERING INFORMATION — X8R HIGH TEMPERATURE CAPACITORS

1206	Y	100	0473	K	N	T
Chip Size	Termination	Voltage	Capacitance in Picofarads (pF)	Capacitance Tolerance	Dielectric Release Codes	Packaging
0805 1206 1210 1808 1812 2220 2225	Y = FlexiCap™ termination base with nickel barrier (100% matte tin plating).	050 = 50V 100 = 100V 200 = 200V 250 = 250V 500 = 500V 630 = 630V 1K0 = 1kV 1K2 = 1.2kV 1K5 = 1.5kV 2K0 = 2kV 2K5 = 2.5kV 3K0 = 3kV	First digit is 0. Second and third digits are significant figures of capacitance code. The fourth digit is number of zeros following. Example: 0473 = 47000pF = 47nF	J = ±5% K = ±10% M = ±20%	N = X8R T = X8R AEC-Q200	T = 178mm (7") reel R = 330mm (13") reel B = Bulk pack — tubs or trays



High Temperature Capacitors — 160°C and 200°C

A range of chip capacitors, available in sizes 0805 to 7565, designed to operate from -55°C to 160°C, (Class II Dielectric) and from -55°C to 200°C (COG/NPO and Class II Dielectrics). Voltage ratings of 25V to 4kV.

MAXIMUM CAPACITANCE VALUES — 160°C COG (F)/CLASS II (G) AND 200°C COG/NPO (D)/CLASS II (E) DIELECTRICS

Size	0805	1206	1210	1515	1808	1812	1825	2225	3530	4540	6560	7565
Tmax	0.054	0.064	0.065	0.130	0.065	0.065	0.080	0.080	0.250	0.300	0.300	0.300
	1.37	1.63	1.65	3.30	1.65	1.65	2.03	2.03	6.35	7.62	7.62	7.62

MAXIMUM CAPACITANCE VALUES — COG/NPO — 160°C (F) AND 200°C (D)

Min cap.	0.5pF	1.0pF	5.0pF	5.0pF	12pF	22pF	33pF	47pF	220pF	39pF	56pF	100pF
25V	2.7nF	5.6nF	12nF	22nF	12nF	22nF	56nF	56nF	100nF	180nF	330nF	390nF
50V	1.8nF	3.9nF	8.2nF	18nF	8.2nF	15nF	39nF	47nF	82nF	150nF	270nF	330nF
100V	680pF	1.8nF	3.3nF	10nF	3.3nF	8.2nF	15nF	18nF	56nF	100nF	220nF	270nF
250V	180pF	1.0nF	2.2nF	3.9nF	2.2nF	5.6nF	12nF	18nF	33nF	56nF	120nF	150nF
500V	100pF	390pF	820pF	2.7nF	1.0nF	2.2nF	3.9nF	5.6nF	12nF	27nF	56nF	68nF
1kV	47pF	100pF	220pF	820pF	220pF	560pF	820pF	1.0nF	5.6nF	15nF	33nF	39nF
2kV	.	27pF	56pF	180pF	56pF	120pF	180pF	270pF	1.5nF	3.3nF	8.2nF	10nF
3kV	.	.	.	82pF	22pF	56pF	82pF	100pF	560pF	1.5nF	3.3nF	3.9nF
4kV	.	.	.	47pF	12pF	27pF	33pF	47pF	330pF	820pF	1.8nF	2.2nF

MAXIMUM CAPACITANCE VALUES — CLASS II — 160°C (G) AND 200°C (E)

Min cap.	120pF	120pF	120pF	150pF	150pF	150pF	470pF	470pF	1.0nF	1.0nF	2.2nF	2.2nF
25V	82nF	220nF	390nF	820nF	330nF	680nF	1.5µF	1.8µF	3.9µF	5.6µF	15µF	18µF
50V	47nF	120nF	220nF	680nF	270nF	470nF	1.0µF	1.2µF	2.7µF	4.7µF	12µF	15µF
100V	18nF	47nF	100nF	270nF	82nF	150nF	470nF	470nF	2.2µF	3.3µF	8.2µF	12µF
250V	4.7nF	10nF	27nF	68nF	22nF	47nF	120nF	150nF	560nF	1.2µF	2.7µF	3.9µF
500V	1.0nF	2.2nF	5.6nF	18nF	5.6nF	10nF	27nF	33nF	120nF	330nF	680nF	820nF
1kV	180pF	390pF	820pF	2.7nF	820pF	1.5nF	4.7nF	5.6nF	27nF	68nF	150nF	220nF
2kV	.	.	150pF	560pF	.	220pF	560pF	680pF	6.8nF	18nF	39nF	47nF
3kV	2.7nF	6.8nF	15nF	18nF
4kV	1.2nF	2.7nF	5.6nF	8.2nF

ORDERING INFORMATION — HIGH TEMPERATURE CAPACITORS

1206	G	224	K	250	N	X050	H	T	M
Chip size	Dielectric codes	Capacitance in picofarads (pF)	Capacitance tolerance code	Voltage code	Termination codes	Thickness options	High Reliability Testing	Packaging	Marking
0805 1206 1210 1515 1808 1812 1825 2225 3530 4540 6560 7565	F = COG/NPO High Temp. (up to 160°C) D = COG/NPO High Temp. (up to 200°C) E = Class II High Temp. (up to 200°C) G = Class II High Temp. (up to 160°C)	Value in Picofarads. Two significant figures, by number of zeros: 224 = 220nF (220,000pF)	F = ±1% (COG/NPO) G = ±2% (COG/NPO) J = ±5% (X8R) K = ±10% (Class II) M = ±20% (Class II)	Two significant figures, followed by number of zeros: 250 = 25 Volts	P = Palladium Silver PR = Palladium Silver* K = Solderable Palladium Silver* N = Nickel Barrier* 100% tin Y = Nickel Barrier* 90% tin, 10% lead C = FlexiCap*/Nickel Barrier* 100% tin D = FlexiCap*/Nickel Barrier* 90% tin, 10% lead S = Solderable Silver* *Indicates RoHS terminations Note: Nickel barrier not available in 200°C dielectric	Blank = Standard thickness "X" = Special thickness, specified in inches: X050 = 0.050"	High Temperature Screening	None = Bulk T = Tape & Reel W = Waffle Pack	None = Unmarked M = Marked Note: Marking not available on sizes <0603



High Temperature HiT Range — 200°C — COG/NPO and X7R

The HiT range of multilayer ceramic capacitors is suitable for a variety of high temperature applications, including: oil exploration, geothermal, military, automotive under-hood and avionics.

This range is manufactured to exacting standards using our unique screen printing process. This provides a high-quality component suitable for demanding applications.

- 200°C operating temperature
- 0603 to 2220 chip sizes
- COG/NPO and X7R dielectric options
- Capacitance range COG/NPO from 4.7pF up to 47nF
- Capacitance range X7R from 100pF up to 4.7μF
- Voltage ratings from 10V to 630V
- RoHS compliant/Pb Free
- Sn over Ni termination
- Sample kits available

Insulation Resistance (IR)

25°C >100GΩ or 1000secs (whichever is the less).
200°C >1GΩ or 10secs (whichever is the less).

Temperature Coefficient of Capacitance (TCC)

COG/NPO 30ppm/°C to +125°C. **X7R** ±15% to +125°C

Aging Rate

COG/NPO Zero. **X7R** Typically less than 2% per time decade.

MAXIMUM CAPACITANCE VALUES — HIGH TEMPERATURE HIT RANGE — 200°C COG/NPO AND X7R

Chip size

Rated Voltage	0603		0805		1206		1210		1808		1812		2220	
	COG/NPO	X7R	COG/NPO	X7R	COG/NPO	X7R	COG/NPO	X7R	COG/NPO	X7R	COG/NPO	X7R	COG/NPO	X7R
Min Cap	3.9pF	100pF	4.7pF	100pF	10pF	100pF	22pF	100pF	22pF	100pF	47pF	150pF	68pF	220pF
10V	470pF	100nF	1.8nF	220nF	3.9nF	820nF	8.2nF	1.2μF	8.2nF	1.2μF	15nF	2.2uF	47nF	4.7μF
16V	470pF	100nF	1.8nF	220nF	3.9nF	820nF	8.2nF	1.2μF	8.2nF	1.2μF	15nF	2.2uF	47nF	4.7μF
25V	470pF	47nF	1.8nF	220nF	3.9nF	820nF	8.2nF	1.2μF	8.2nF	1.2μF	15nF	2.2uF	47nF	4.7μF
50V	470pF	15nF	1.8nF	100nF	3.9nF	270nF	8.2nF	680nF	8.2nF	560nF	15nF	1.5uF	47nF	2.2μF
100V	390pF	8.2nF	1.5nF	33nF	3.3nF	100nF	5.6nF	270nF	6.8nF	180nF	12nF	560nF	39nF	1.0μF
200V	180pF	1.2nF	820pF	6.8nF	1.8nF	27nF	3.9nF	68nF	3.9nF	47nF	10nF	82nF	39nF	120nF
250V	120pF	820pF	470pF	3.9nF	1.0nF	15nF	2.2nF	47nF	2.2nF	27nF	5.6nF	56nF	12nF	82nF
500V	100pF	270pF	220pF	1.5nF	820pF	3.9nF	1.5nF	12nF	1.8nF	12nF	4.7nF	18nF	10nF	68nF
630V	-	-	68pF	-	330pF	-	820pF	-	820pF	-	2.7nF	-	6.8nF	-

Note: Other capacitance values may become available; please contact the Sales Office if you need values other than those shown in the above table. For dimensions and soldering information, visit knowlescapacitors.com.

ORDERING INFORMATION — NOVACAP BRAND — HIGH TEMPERATURE HIT RANGE

1206	RE	331	J	501	N	H	T	
Case size	Dielectric	Capacitance in picofarads (pF)	Capacitance tolerance	Voltage	Termination	Screening	Packaging	
0603 0805 1206 1210 1808 1812 2220	RD = COG/NPO (200°C) RE = X7R (200°C)	First and Second digits are significant figures of capacitance code. The fourth digit is number of zeros following. Example: 103 = 10000pF R = decimal	COG/NPO F = ±1% G = ±2% J = ±5% K = ±10%	X7R J = ±5% K = ±10% M = ±20%	100 = 10V 160 = 16V 250 = 25V 500 = 50V 101 = 100V 201 = 200V 251 = 250V 501 = 500V 631 = 630V	N = Nickel barrier with 100% matte tin plating. RoHS compliant. Lead free.	H = High Temp Screening — if required	T = 178mm (7") reel 330mm (13") reel None = Bulk pack — tubs

ORDERING INFORMATION — SYFER BRAND — HIGH TEMPERATURE HIT RANGE

1206	J	100	0103	M	X	T	H20
Chip size	Termination	Voltage	Capacitance in picofarads (pF)	Capacitance tolerance	Dielectric	Packaging	Suffix Code
0603 0805 1206 1210 1808 1812 2220	J = Nickel barrier with 100% matte tin plating. RoHS compliant. Lead free.	010 = 10V 016 = 16V 025 = 25V 050 = 50V 063 = 63V 100 = 100V 200 = 200V 250 = 250V 500 = 500V 630 = 630V	≥1.0pF & <10pF Insert a P for the decimal point as the second character. e.g., 8P20 = 8.2pF ≥10pF First digit is zero. Second and third digits are significant figures of capacitance code. The fourth digit is the number of zeros following. e.g., 0101 = 100pF	COG/NPO F = ±1% G = ±2% J = ±5% K = ±10%	X7R J = ±5% K = ±10% M = ±20%	G = COG/NPO (BME) X = X7R	T = 178mm (7") reel R = 330mm (13") reel B = Bulk pack — tubs H20 HiT250 range

High Temperature HiT250 Range — 250°C — COG/NPO and X7R

The HiT250 range of multilayer ceramic capacitors is suitable for a variety of high temperature applications including: oil exploration, geothermal, military, automotive under-hood and avionics.

This range is manufactured to exacting standards using our uniquescreen printing process. This provides a high quality component suitable for demanding applications.

- 250°C operating temperature
- 0603 to 2220 chip sizes
- COG/NPO (1B) and X7R dielectric options
- Capacitance range COG/NPO (1B) from 3.9pF up to 39nF
- Capacitance range X7R (2R1) from 1nF up to 2.2µF
- Voltage ratings from 10V to 630V
- RoHS compliant / Pb Free
- Au over Ni termination
- Sample kits available

Insulation Resistance (IR)

25°C >100GΩ or 1000secs (whichever is the less).
250°C >100MΩ or 1sec (whichever is the less).

Temperature Coefficient of Capacitance (TCC)

COG/NPO 30ppm/°C to +125°C. X7R ±15% to +125°C

Aging Rate

COG/NPO Zero. X7R Typically less than 2% per time decade.

MAXIMUM CAPACITANCE VALUES — HIGH TEMPERATURE HIT250 RANGE — 250°C COG/NPO AND X7R

Rated Voltage	Chip size													
	0603		0805		1206		1210		1808		1812		2220	
	COG/NPO	X7R	COG/NPO	X7R	COG/NPO	X7R	COG/NPO	X7R	COG/NPO	X7R	COG/NPO	X7R	COG/NPO	X7R
Min Cap	3.9pF	1.0nF	4.7pF	4.7nF	10pF	15nF	22pF	33nF	22pF	100nF	47pF	82nF	68pF	470nF
10V	390pF	100nF	1.5nF	150nF	3.3nF	330nF	5.6nF	680nF	5.6nF	560nF	12nF	1.5uF	39nF	2.2µF
16V	390pF	33nF	1.5nF	100nF	3.3nF	180nF	5.6nF	470nF	5.6nF	330nF	12nF	1.0uF	39nF	1.5µF
25V	390pF	10nF	1.5nF	47nF	3.3nF	150nF	5.6nF	330nF	5.6nF	270nF	12nF	680nF	39nF	1.0µF
50V	390pF	-	1.5nF	-	3.3nF	-	5.6nF	-	5.6nF	-	12nF	-	39nF	-
100V	330pF	-	1.0nF	-	2.7nF	-	3.9nF	-	4.7nF	-	10nF	-	27nF	-
200V	120pF	-	560pF	-	1.2nF	-	2.7nF	-	2.7nF	-	6.8nF	-	15nF	-
250V	68pF	-	330pF	-	680pF	-	1.8nF	-	1.8nF	-	4.7nF	-	10nF	-
500V	33pF	-	120pF	-	390pF	-	820pF	-	1.0nF	-	2.2nF	-	4.7nF	-
630V	-	-	39pF	-	150pF	-	470pF	-	470pF	-	1.5nF	-	2.2nF	-

Note: Other capacitance values may become available, please contact the Sales Office if you need values other than those shown in the above table.
For dimensions and soldering information, please go to our website www.knowlescapacitors.com

ORDERING INFORMATION — NOVACAP BRAND — HIGH TEMPERATURE HIT250 RANGE

1206	HD	272	F	101	NG	H	T
Case size	Dielectric	Capacitance in picofarads (pF)	Capacitance tolerance	Voltage	Termination	Screening	Packaging
0603 0805 1206 1210 1808 1812 2220	HD = COG/NPO (250°C) HE = X7R (250°C)	First and Second digits are significant figures of capacitance code. The fourth digit is number of 0's following. Example : 103 = 10000pF R = decimal	COG/NPO F = ±1% G = ±2% J = ±5% K = ±10%	X7R J = ±5% K = ±10% M = ±20%	100 = 10V 160 = 16V 250 = 25V 500 = 50V 101 = 100V 201 = 200V 251 = 250V 501 = 500V 631 = 630V	NG = Nickel barrier with gold flash. RoHS compliant. Lead Free.	H = High Temp Screening - if required T = 178mm (7") reel 330mm (13") reel None = Bulk pack - tubs

ORDERING INFORMATION — SYFER BRAND — HIGH TEMPERATURE HIT250 RANGE

1206	G	500	391	J	G	T	H25
Chip size	Termination	Voltage	Capacitance in picofarads (pF)	Capacitance tolerance	Dielectric	Packaging	Suffix Code
0603 0805 1206 1210 1808 1812 2220	G = Nickel barrier with gold flash. RoHS compliant. Lead Free.	010 = 10V 016 = 16V 025 = 25V 050 = 50V 063 = 63V 100 = 100V 200 = 200V 250 = 250V 500 = 500V 630 = 630V	≥1.0pF & <10pF Insert a P for the decimal point as the second character. e.g., 8P20 = 8.2pF ≥10pF First digit is 0. Second and third digits are significant figures of capacitance code. The fourth digit is the number of zeros following. e.g., 0101 = 100pF	COG/NPO F = ±1% G = ±2% J = ±5% K = ±10%	X7R J = ±5% K = ±10% M = ±20%	G = COG/NPO (BME) X = X7R	T = 178mm (7") reel R = 330mm (13") reel B = Bulk pack - tubs H25 HiT250 range



Capacitor Assemblies — ST and SM — COG/NPO and X7R

Our complete testing facility is available for any additional military testing requirements. Options available include thru-hole and surface mount lead styles, to make them suitable for mounting on ceramic substrates or epoxy PCBs.

Consult the Sales Office if your specific requirements exceed our catalog maximums (size, cap. value and voltage). These ranges of both High Capacitance and High Voltage MLC assemblies are available in COG/NPO and X7R dielectrics. Low ESR and Low ESL are inherent in the design, giving the assemblies a high capability up to 1MHz, and offer far superior performance than either Aluminium or Tantalum electrolytic capacitors.

They are designed for use in high power or high frequency applications such as switched mode power supplies, DC-DC converters, high capacitance discharge circuits and high temperature filtering/decoupling. They can be made with up to five same size chips with various lead configurations to safeguard against thermal and mechanical stresses.

The commercial "ST" series provide the highest capacitance available and are 100% tested for Dielectric Withstanding Voltage, Insulation Resistance, Capacitance and Dissipation Factor.

In contrast, the High Reliability "SM" series is designed and tested for military and industrial applications and tested as per of MIL-PRF-49470 (DSCC 87106), Group A.

NN or NP (no leads)

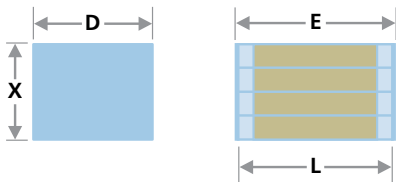

LN (straight leads)

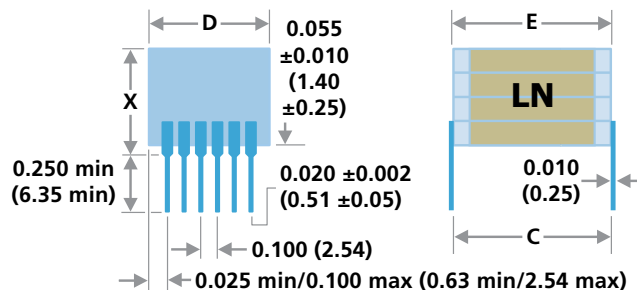

TJ & TL (tab leads)

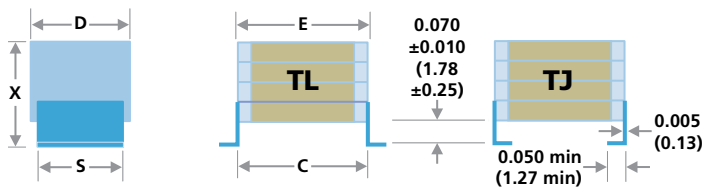

LJ & LL (bent leads)

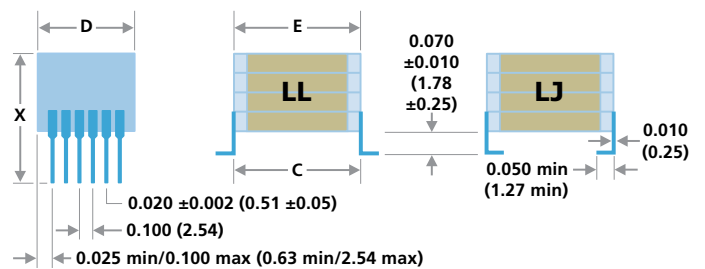

Capacitor Assemblies — ST and SM — COG/NP0 and X7R

MAXIMUM STACK HEIGHT, X DIMENSION — INCHES/MM

No. of chips	Chip size	Style NN, NP	Style TJ & TL	Style LN, LJ & LL
1	1812	0.100/2.54	0.180/4.57	N/A
	1825	0.100/2.54	0.180/4.57	0.180/4.57
	2225	0.120/3.05	0.200/5.08	0.200/5.08
	>2225	N/A	0.200/5.08	0.200/5.08
2	1812	0.200/5.08	0.280/7.11	N/A
	1825	0.200/5.08	0.280/7.11	0.280/7.11
	2225	0.240/6.10	0.320/8.13	0.320/8.13
	>2225	N/A	0.320/8.13	0.320/8.13
3	812	0.300/7.62	0.380/9.65	N/A
	1825	0.300/7.62	0.380/9.65	0.380/9.65
	2225	0.360/9.14	0.440/11.2	0.440/11.20
	>2225	N/A	0.440/11.2	0.440/11.20
4	1812	0.400/10.20	0.480/12.2	N/A
	1825	0.400/10.20	0.480/12.2	0.480/12.20
	2225	0.480/12.20	0.560/14.2	0.560/14.20
	>2225	N/A	0.560/14.2	0.560/14.20
5	1812	0.520/13.20	0.600/15.2	N/A
	1825	0.520/13.20	0.600/15.2	0.600/15.2
	2225	0.635/16.10	0.715/18.2	0.715/18.2
	>2225	N/A	0.715/18.2	0.715/18.2

DIMENSIONS — INCHES/MM

Size	1812	1825	2225	3640	4540	5550	7565
C*	0.210/ 5.33	0.210/5.33	0.250/6.35	0.400/10.20	0.480/12.20	0.580/14.70	0.780/19.80
D*	0.125/3.18	0.250/6.35	0.250/6.35	0.400/10.20	0.400/10.20	0.500/12.70	0.650**/16.50
E max	0.260/6.60	0.260/6.60	0.300/7.62	0.430/10.90	0.530/13.50	0.630/16.00	0.830/21.10
L nom	0.180/4.57	0.180/4.57	0.220/5.59	0.360/9.14	0.450/11.40	0.550/14.00	0.750/19.10
Leads per side	N/A	3	3	4	4	5	6

Notes: 1) *C & D inches ± 0.025 /mm ± 0.64 ; 2) ** ± 0.035 /0.89

ORDERING INFORMATION — ST AND SM CAPACITOR ASSEMBLIES

ST	3640	B	474	M	101	LJ	X	W	-5	R
Style	Size	Dielectric	Capacitance	Tolerance	Voltage VDCW	Lead style	Thickness option	Packing	No. Chips	RoHS
ST = Commercial SM = High Reliability	See Chart	N = COG/NP0 B = X7R	Value in Picofarads. Two significant figures, followed by number of zeros: 825 = 8,200,000pF (8.2 μ F)	F = $\pm 1\%$ * B = $\pm 2\%$ * H = $\pm 3\%$ * J = $\pm 5\%$ K = $\pm 10\%$ M = $\pm 20\%$ Z = +80 -20% P = +100 -0%	Two significant figures, followed by number of zeros: 101 = 100V	LN = Straight* LL = L Lead* LJ = J Lead* TL = L Tab TJ = J tab NN = Nickel NP = Pd/Ag	Specify standoff dimension if less than max.	W = Waffle T = Tape & Reel*	1 to 5	$\geq 250V$ RoHS
				*COG/NP0 only		*Not 1812		*Consult the sales office		



Capacitor Assemblies — ST and SM — COG/NPO

COG/NPO CAPACITANCE AND VOLTAGE SELECTION

Note: Capacitance values are shown as 3-digit code: 2 significant figures followed by the no. of zeros, e.g., 183 = 18,000pF.

4540								5550								6560								7565								Size	
50V		100V		200V		500V		50V		100V		200V		500V		50V		100V		200V		500V		50V		100V		200V		500V		Rated Voltage	
ST	SM	ST	SM	ST	SM	ST	SM	ST	SM	ST	SM	ST	SM	ST	SM	ST	SM	ST	SM	ST	SM	ST	SM	ST	SM	ST	SM	ST	SM	ST	SM	Cap	Code
																																10pF	100
																																12	120
																																15	150
																																18	180
																																22	220
																																27	270
																																33	330
1	1	1	1	1	1	1	1	1	1	1	1	1	1	1	1	1	1	1	1	1	1	1	1	1	1	1	1	1	1	1	1	39	390
1	1	1	1	1	1	1	1	1	1	1	1	1	1	1	1	1	1	1	1	1	1	1	1	1	1	1	1	1	1	1	1	47	470
1	1	1	1	1	1	1	1	1	1	1	1	1	1	1	1	1	1	1	1	1	1	1	1	1	1	1	1	1	1	1	1	56	560
1	1	1	1	1	1	1	1	1	1	1	1	1	1	1	1	1	1	1	1	1	1	1	1	1	1	1	1	1	1	1	1	68	680
1	1	1	1	1	1	1	1	1	1	1	1	1	1	1	1	1	1	1	1	1	1	1	1	1	1	1	1	1	1	1	1	82	820
1	1	1	1	1	1	1	1	1	1	1	1	1	1	1	1	1	1	1	1	1	1	1	1	1	1	1	1	1	1	1	1	100pF	101
1	1	1	1	1	1	1	1	1	1	1	1	1	1	1	1	1	1	1	1	1	1	1	1	1	1	1	1	1	1	1	1	120	121
1	1	1	1	1	1	1	1	1	1	1	1	1	1	1	1	1	1	1	1	1	1	1	1	1	1	1	1	1	1	1	1	150	151
1	1	1	1	1	1	1	1	1	1	1	1	1	1	1	1	1	1	1	1	1	1	1	1	1	1	1	1	1	1	1	1	180	181
1	1	1	1	1	1	1	1	1	1	1	1	1	1	1	1	1	1	1	1	1	1	1	1	1	1	1	1	1	1	1	1	220	221
1	1	1	1	1	1	1	1	1	1	1	1	1	1	1	1	1	1	1	1	1	1	1	1	1	1	1	1	1	1	1	1	270	271
1	1	1	1	1	1	1	1	1	1	1	1	1	1	1	1	1	1	1	1	1	1	1	1	1	1	1	1	1	1	1	1	330	331
1	1	1	1	1	1	1	1	1	1	1	1	1	1	1	1	1	1	1	1	1	1	1	1	1	1	1	1	1	1	1	1	390	391
1	1	1	1	1	1	1	1	1	1	1	1	1	1	1	1	1	1	1	1	1	1	1	1	1	1	1	1	1	1	1	1	470	471
1	1	1	1	1	1	1	1	1	1	1	1	1	1	1	1	1	1	1	1	1	1	1	1	1	1	1	1	1	1	1	1	560	561
1	1	1	1	1	1	1	1	1	1	1	1	1	1	1	1	1	1	1	1	1	1	1	1	1	1	1	1	1	1	1	1	680	681
1	1	1	1	1	1	1	1	1	1	1	1	1	1	1	1	1	1	1	1	1	1	1	1	1	1	1	1	1	1	1	1	820	821
1	1	1	1	1	1	1	1	1	1	1	1	1	1	1	1	1	1	1	1	1	1	1	1	1	1	1	1	1	1	1	1	10nF	102
1	1	1	1	1	1	1	1	1	1	1	1	1	1	1	1	1	1	1	1	1	1	1	1	1	1	1	1	1	1	1	1	1.2	122
1	1	1	1	1	1	1	1	1	1	1	1	1	1	1	1	1	1	1	1	1	1	1	1	1	1	1	1	1	1	1	1	1.5	152
1	1	1	1	1	1	1	1	1	1	1	1	1	1	1	1	1	1	1	1	1	1	1	1	1	1	1	1	1	1	1	1	1.8	182
1	1	1	1	1	1	1	1	1	1	1	1	1	1	1	1	1	1	1	1	1	1	1	1	1	1	1	1	1	1	1	1	2.2	222
1	1	1	1	1	1	1	1	1	1	1	1	1	1	1	1	1	1	1	1	1	1	1	1	1	1	1	1	1	1	1	1	2.7	272
1	1	1	1	1	1	1	1	1	1	1	1	1	1	1	1	1	1	1	1	1	1	1	1	1	1	1	1	1	1	1	1	3.3	332
1	1	1	1	1	1	1	1	1	1	1	1	1	1	1	1	1	1	1	1	1	1	1	1	1	1	1	1	1	1	1	1	3.9	392
1	1	1	1	1	1	1	1	1	1	1	1	1	1	1	1	1	1	1	1	1	1	1	1	1	1	1	1	1	1	1	1	4.7	472
1	1	1	1	1	1	1	1	1	1	1	1	1	1	1	1	1	1	1	1	1	1	1	1	1	1	1	1	1	1	1	1	5.6	562
1	1	1	1	1	1	1	1	1	1	1	1	1	1	1	1	1	1	1	1	1	1	1	1	1	1	1	1	1	1	1	1	6.8	682
1	1	1	1	1	1	1	1	1	1	1	1	1	1	1	1	1	1	1	1	1	1	1	1	1	1	1	1	1	1	1	1	8.2	822
1	1	1	1	1	1	1	1	1	1	1	1	1	1	1	1	1	1	1	1	1	1	1	1	1	1	1	1	1	1	1	1	10nF	103
1	1	1	1	1	1	1	1	1	1	1	1	1	1	1	1	1	1	1	1	1	1	1	1	1	1	1	1	1	1	1	1	12	123
1	1	1	1	1	1	1	1	1	1	1	1	1	1	1	1	1	1	1	1	1	1	1	1	1	1	1	1	1	1	1	1	15	153
1	1	1	1	1	1	1	1	1	1	1	1	1	1	1	1	1	1	1	1	1	1	1	1	1	1	1	1	1	1	1	1	18	183
1	1	1	1	1	1	1	1	1	1	1	1	1	1	1	1	1	1	1	1	1	1	1	1	1	1	1	1	1	1	1	1	22	223
1	1	1	1	1	1	1	1	1	1	1	1	1	1	1	1	1	1	1	1	1	1	1	1	1	1	1	1	1	1	1	1	27	273
1	1	1	1	1	1	1	1	1	1	1	1	1	1	1	1	1	1	1	1	1	1	1	1	1	1	1	1	1	1	1	1	33	333
1	1	1	1	1	1	1	1	1	1	1	1	1	1	1	1	1	1	1	1	1	1	1	1	1	1	1	1	1	1	1	1	39	393
1	1	1	1	1	1	1	1	1	1	1	1	1	1	1	1	1	1	1	1	1	1	1	1	1	1	1	1	1	1	1	1	47	473
1	1	1	1	1	1	1	1	1	1	1	1	1	1	1	1	1	1	1	1	1	1	1	1	1	1	1	1	1	1	1	1	56	563
1	1	1	1	1	1	1	1	1	1	1	1	1	1	1	1	1	1	1	1	1	1	1	1	1	1	1	1	1	1	1	1	68	683
1	1	1	1	1	1	1	1	1	1	1	1	1	1	1	1	1	1	1	1	1	1	1	1	1	1	1	1	1	1	1	1	82	823
1	1	1	1	1	1	1	1	1	1	1	1	1	1	1	1	1	1	1	1	1	1	1	1	1	1	1	1	1	1	1	1	100nF	104
1	1	1	1	1	1	1	1	1	1	1	1	1	1	1	1	1	1	1	1	1	1	1	1	1	1	1	1	1	1	1	1	120	124
1	1	1	1	1	1	1	1	1	1	1	1	1	1	1	1	1	1	1	1	1	1	1	1	1	1	1	1	1	1	1	1	150	154
1	1	1	1	1	1	1	1	1	1	1	1	1	1	1	1	1	1	1	1	1	1	1	1	1	1	1	1	1	1	1	1	180	184
1	1	1	1	1	1	1	1	1	1	1	1	1	1	1	1	1	1	1	1	1	1	1	1	1	1	1	1	1	1	1	1	220	224
2	2	2	2	2	2	2	2	1	1	1	1	1	1	1	1	1	1	1	1	1	1	1	1	1	1	1	1	1	1	1	1	270	274
2	2	2	2	2	2	2	2	2	2	2	2	2	2	2	2	1	1	1	1	1	1	1	1	1	1	1	1	1	1	1	1	330	334
2	2	2																															

Capacitor Assemblies — ST and SM — X7R

X7R CAPACITANCE AND VOLTAGE SELECTION

Size		1812								1825								2225								3640							
Vdc		50V		100V		200V		500V		50V		100V		200V		500V		50V		100V		200V		500V		50V		100V		200V		500V	
Cap	Code	ST	SM	ST	SM	ST	SM	ST	SM	ST	SM	ST	SM	ST	SM	ST	SM	ST	SM	ST	SM	ST	SM	ST	SM	ST	SM	ST	SM	ST	SM		
1.0nF	102	1	1	1	1	1	1	1	1	1	1	1	1	1	1	1	1	1	1	1	1	1	1	1	1	1	1	1	1	1	1		
1.2	122	1	1	1	1	1	1	1	1	1	1	1	1	1	1	1	1	1	1	1	1	1	1	1	1	1	1	1	1	1	1		
1.5	152	1	1	1	1	1	1	1	1	1	1	1	1	1	1	1	1	1	1	1	1	1	1	1	1	1	1	1	1	1	1		
1.8	182	1	1	1	1	1	1	1	1	1	1	1	1	1	1	1	1	1	1	1	1	1	1	1	1	1	1	1	1	1	1		
2.2	222	1	1	1	1	1	1	1	1	1	1	1	1	1	1	1	1	1	1	1	1	1	1	1	1	1	1	1	1	1	1		
2.7	272	1	1	1	1	1	1	1	1	1	1	1	1	1	1	1	1	1	1	1	1	1	1	1	1	1	1	1	1	1	1		
3.3	332	1	1	1	1	1	1	1	1	1	1	1	1	1	1	1	1	1	1	1	1	1	1	1	1	1	1	1	1	1	1		
3.9	392	1	1	1	1	1	1	1	1	1	1	1	1	1	1	1	1	1	1	1	1	1	1	1	1	1	1	1	1	1	1		
4.7	472	1	1	1	1	1	1	1	1	1	1	1	1	1	1	1	1	1	1	1	1	1	1	1	1	1	1	1	1	1	1		
5.6	562	1	1	1	1	1	1	1	1	1	1	1	1	1	1	1	1	1	1	1	1	1	1	1	1	1	1	1	1	1	1		
6.8	682	1	1	1	1	1	1	1	1	1	1	1	1	1	1	1	1	1	1	1	1	1	1	1	1	1	1	1	1	1	1		
8.2	822	1	1	1	1	1	1	1	1	1	1	1	1	1	1	1	1	1	1	1	1	1	1	1	1	1	1	1	1	1	1		
10nF	103	1	1	1	1	1	1	1	1	1	1	1	1	1	1	1	1	1	1	1	1	1	1	1	1	1	1	1	1	1	1		
12	123	1	1	1	1	1	1	1	1	1	1	1	1	1	1	1	1	1	1	1	1	1	1	1	1	1	1	1	1	1	1		
15	153	1	1	1	1	1	1	1	1	1	1	1	1	1	1	1	1	1	1	1	1	1	1	1	1	1	1	1	1	1	1		
18	183	1	1	1	1	1	1	1	1	1	1	1	1	1	1	1	1	1	1	1	1	1	1	1	1	1	1	1	1	1	1		
22	223	1	1	1	1	1	1	1	1	1	1	1	1	1	1	1	1	1	1	1	1	1	1	1	1	1	1	1	1	1	1		
27	273	1	1	1	1	1	1	1	1	1	1	1	1	1	1	1	1	1	1	1	1	1	1	1	1	1	1	1	1	1	1		
33	333	1	1	1	1	1	1	1	1	1	1	1	1	1	1	1	1	1	1	1	1	1	1	1	1	1	1	1	1	1	1		
39	393	1	1	1	1	1	1	1	1	1	1	1	1	1	1	1	1	1	1	1	1	1	1	1	1	1	1	1	1	1	1		
47	473	1	1	1	1	1	1	1	1	1	1	1	1	1	1	1	1	1	1	1	1	1	1	1	1	1	1	1	1	1	1		
56	563	1	1	1	1	1	1	1	1	1	1	1	1	1	1	1	1	1	1	1	1	1	1	1	1	1	1	1	1	1	1		
68	683	1	1	1	1	1	1	1	2	1	1	1	1	1	1	1	1	1	1	1	1	1	1	1	1	1	1	1	1	1	1		
82	823	1	1	1	1	1	1	1	2	1	1	1	1	1	1	1	1	1	1	1	1	1	1	1	1	1	1	1	1	1	1		
100nF	104	1	1	1	1	1	1	1	2	1	1	1	1	1	1	1	1	1	1	1	1	1	1	1	1	1	1	1	1	1	1		
120	124	1	1	1	1	1	1	2	2	1	1	1	1	1	1	1	1	1	1	1	1	1	1	1	1	1	1	1	1	1	1		
150	154	1	1	1	1	1	1	2	3	1	1	1	1	1	1	1	2	1	1	1	1	1	1	1	1	1	1	1	1	1	1		
180	184	1	1	1	1	1	1	2	3	1	1	1	1	1	1	1	2	1	1	1	1	1	1	1	1	1	1	1	1	1	1		
220	224	1	1	1	1	1	1	3	4	1	1	1	1	1	1	1	2	1	1	1	1	1	1	1	2	1	1	1	1	1	1		
270	274	1	1	1	1	1	1	3	5	1	1	1	1	1	1	2	3	1	1	1	1	1	1	1	2	1	1	1	1	1	1		
330	334	1	1	1	1	1	1	4		1	1	1	1	1	1	2	3	1	1	1	1	1	1	1	2	1	1	1	1	1	1		
390	394	1	1	1	1	1	1	4		1	1	1	1	1	1	2	4	1	1	1	1	1	1	1	2	3	1	1	1	1	1		
470	474	1	1	1	1	1	1	5		1	1	1	1	1	1	3	4	1	1	1	1	1	1	2	3	1	1	1	1	1	2		
560	564	1	1	1	1	2	2			1	1	1	1	1	1	3	5	1	1	1	1	1	1	2	4	1	1	1	1	1	2	2	
680	684	1	1	2	2	2	3			1	1	1	1	1	2	4		1	1	1	1	1	1	3	4	1	1	1	1	1	2	2	
820	824	2	2	2	2	2	3			1	1	1	1	1	2	4		1	1	1	1	1	1	3	5	1	1	1	1	1	2	3	
1.0µF	105	2	2	2	2	2	3	3		1	1	1	1	2	2	5		1	1	1	1	1	2	4		1	1	1	1	1	2	3	
1.2	125	2	2	2	2	3	4			1	1	1	2	2	3			1	1	1	1	2	2	4		1	1	1	1	1	3	3	
1.5	155	2	3	3	3	4	5			2	2	2	2	2	3			1	1	1	1	2	2	5		1	1	1	1	1	3	4	
1.8	185	3	3	3	3	4				2	2	2	2	3	4			1	2	2	2	2	3			1	1	1	1	1	2	4	5
2.2	225	3	3	4	4	5				2	2	2	3	3	4			2	2	2	2	2	3			1	1	1	1	2	2	5	
2.7	275	4	4	4	5					2	3	3	3	4	5			2	2	2	2	3	4			1	1	1	2	2	2		
3.3	335	5	5		5					3	3	3	4	4				2	2	3	3	3	4			1	1	2	2	2	3		
3.9	395	5								3	3	4	4	5				3	3	3	3	4	5			1	1	2	2	3	3		
4.7	475									4	4	4	5					3	3	4	4	5				2	2	2	2	3	3		
5.6	565									4	5	5						4	4	4	4					2	2	2	3	3	4		
6.8	685									5									4	4	5	5					2	2	3	3	4	5	
8.2	825																		5	5							2	2	3	4	5		
10µF	106																										3	3	4	4			
12	126																										3	3	4	5			
15	156																										4	4	5				
18	186																										4	5					
22	226																										5						
27	276																																
33	336																																
39	396																																
47	476																																
56	566																																
68	686																																
82	826																																
100µF	107																																

Number of chips required to achieve the capacitance value



Capacitor Assemblies — "Cap-Rack" Arrays

The "Cap-Rack" (US Patent 6,058,004) is an assembly of individual chip capacitors, bonded with high temperature epoxy. A "Cap-Rack" can be made up of a pair, to as many as eight, same-size chips — 0603, 0805, 1005, 1206, 1210, 1808, 1812, 1825, 2221 and 2225 — into one single component providing extended freedom for PCB space utilization. Footprint dimensions can also vary to further optimize board space usage. The patented design allows the chips to behave as individual components, not as a single large ceramic mass, and therefore reduces harmful thermal stress during assembly. Typical applications are in Multi-line designs, Mobile phones, Automotive, Computers, Network Devices and Medical products.

Electrical advantages include reduction in "cross talk," to insignificant levels, by elimination of capacitance coupling between adjacent capacitors; the ability to combine resistors and inductors within the "Cap-Rack", as well as mixing and matching capacitance values and dielectrics.

Mechanical advantages include reduced board area; easier to handle; reduced placement cost; reduced component stress and decreased cycle time. "Cap-Rack" can also be used with traditional pick and place equipment.

Consult the sales office for High Reliability versions and custom designs, particularly for high voltage applications.

- For dielectric characteristics, see pages 6 to 8.
- For dimensions of individual chips, see page 23.
- P and AW dimensions are dependant on the chips utilized in the array.
- Cap Arrays require drawings to specify length and width of array and chip size used. Please contact the Sales Office.

DIMENSIONS — INCHES/MM

Size	0603	0805	1005	1206	1210	1808	1812	1825	2221	2225
Max number of Caps	6	6	6	6	6	6	8	8	8	8

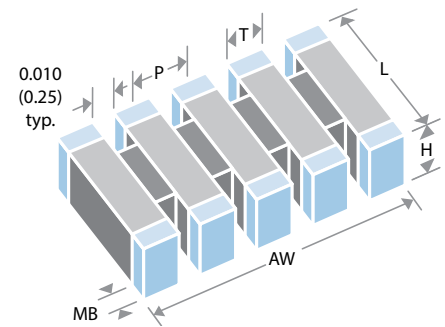

ORDERING INFORMATION — "CAP-RACK" ARRAYS

CR	1206	N	562	K	101	N	H	T	- 4
Style	Size	Dielectric	Capacitance in picofarads (pF)	Capacitance tolerance	Voltage d.c.	Termination	Hi-Rel Option	Packing	No. of chips
Cap-Rack	Size of individual chips that make up the array	N = COG/NPO B = X7R	Value in Picofarads. Two significant figures, followed by number of zeros: 562 = 5600pF	B = 0.10pF* C = 0.25pF* D = 0.50pF* F = ± 1.0%* G = ± 2.0%* H = ± 3.0%* J = ± 5% K = ± 10% M = ± 20% Z = +80% -20% P = +100% -0% *COG/NPO only	Two significant figures, followed by number of zeros: 101 = 100V	N = Nickel Barrier (100% tin) P = Palladium Silver Y = Nickel Barrier (90% tin/10% lead)	Ref: MIL-PRF-55681 & MIL-PRF-123	T = Tape & Reel W = Waffle Pack	



Capacitor Assemblies SV2220

The SV capacitor assemblies are a vertical stacking of ceramic capacitors, offering far superior performance than either aluminum or tantalum electrolytic capacitors. They can be made with up to 10 same size chips with various lead configurations to safeguard against thermal and mechanical stresses and are 100% tested for dielectric withstanding voltage, insulation resistance, capacitance and dissipation factor.

They are ideally suited for the input and output stages of switch-mode power supplies and DC-DC converters; the SV capacitor assemblies offer several key benefits:

- Reduces the overall circuit board footprint
- High capacitance to volume ratio
- Low ESR and low ESL
- Capability to handle high ripple currents at high frequencies

ELECTRICAL SPECIFICATIONS

DIELECTRIC WITHSTANDING VOLTAGE:	250% of rated voltage for 5 seconds
INSULATION RESISTANCE AT 25°C:	500 mega-ohm/micro-farad minimum
INSULATION RESISTANCE AT 125°C:	50 mega-ohm/micro-farad minimum
CAPACITANCE AT 25°C:	1.0±0.2 VRMS at 120 Hz
DISSIPATION FACTOR AT 25°C	5% maximum at 1.0±0.2 VRMS at 120 Hz
LIFE TEST:	150% of rated voltage at 125°C for 1000 hours
MOISTURE RESISTANCE:	10 cycles without voltage. MIL-STD-202 M106
THERMAL SHOCK:	MIL-STD-202 M107, test condition A -55°C to +125°C
IMMERSION CYCLING:	MIL-STD-20 M104, condition B
RESISTANCE TO SOLDER HEAT:	MIL-STD-202, M210, condition B 20 seconds at 260°C



Capacitor Assemblies SV2220

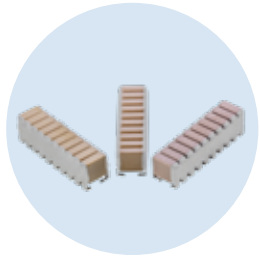

Applications

- Input and output stages of switch-mode power supplies and DC-DC converters

Benefits

- Reduces the overall circuit board footprint
- Low ESR and low ESL
- High capacitance to volume ratio
- Superior performance over aluminum or tantalum capacitors

		Capacitance (μF)						
		14	22	27	47	68	100	220
Voltage	25V					-3	-5	-10
	50V			-3	-5		-10	
	100V	-3	-5		-10			

Note: Dash number denotes number of capacitors and leads per side.

		Typical ESR (Ohms)				
		22 μF	27 μF	47 μF	100 μF	220 μF
ESR @ 1kHz		0.0830	0.0680	0.0400	0.0240	0.0110
ESR @ 10kHz		0.0086	0.0070	0.0040	0.0033	0.0015
ESR @ 50kHz		0.0044	0.0031	0.0020	0.0013	0.0006
ESR @ 100kHz		0.0032	0.0022	0.0015	0.0009	0.0004



Capacitor Assemblies SV2220

LN (STRAIGHT WIRE LEADS)

LJ AND LL (BENT WIRE LEADS)

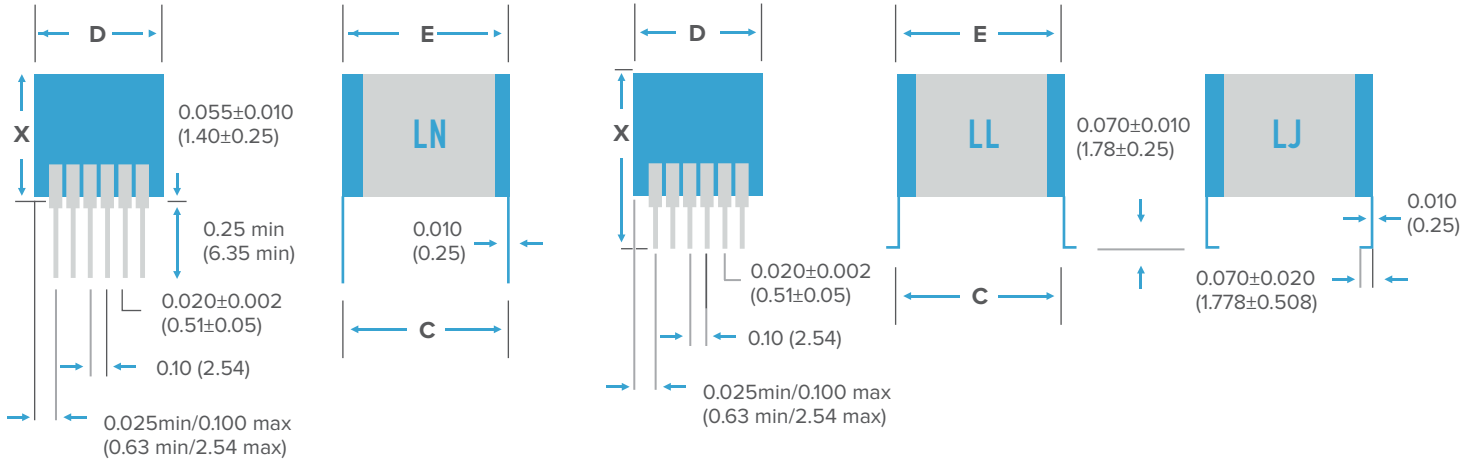

NUMBER	STYLE	C ±.025"	D (MAX)	E (MAX)	X (MAX)
-3	LN	.250" (6.35)	.375" (9.5)	.300" (7.62)	.285" (7.24)
-3	LJ, LL	.250" (6.35)	.375" (9.5)	.300" (7.62)	.300" (7.62)
-5	LN	.250" (6.35)	.575" (14.6)	.300" (7.62)	.285" (7.24)
-5	LJ, LL	.250" (6.35)	.575" (14.6)	.300" (7.62)	.300" (7.62)
-10	LN	.250" (6.35)	1.075" (27.3)	.300" (7.62)	.285" (7.24)
-10	LJ, LL	.250" (6.35)	1.075" (27.3)	.300" (7.62)	.300" (7.62)

SV	2220	BB	476	M	101	LJ	W	-10	R
SERIES	SIZE	DIELECTRIC	CAPACITANCE	TOLERANCE	VOLTAGE VDCW	LEAD STYLE	PACKAGING	CAPS/LEADS	RoHS
	See Chart	BB = X7R Class II BME	Value in picofarads — two significant figures, followed by number of zeros: 476 = 47,000,000pF	M = +/-20%	Two significant figures, followed by number of zeros: 250 = 25V 500 = 50V 101 = 100V	LN = Straight LL = L Lead LJ = J Lead	W = Waffle Pack	Number of caps and leads per side	R = RoHS compliant with exemption 7a R = 100% Sn finish on lead No R on P/N = 60Sn/40Pb finish on leads



Radial Leaded Capacitors — Ordering Information

NOVACAP ORDERING INFORMATION — RADIAL LEADED — STANDARD AND HIGH REL

0805	B	123	K	501	LE	A	R
Size	Dielectric	Capacitance	Tolerance	Voltage-VDCW	Lead Styles	Packing	RoHS
See charts	N = COG/NPO RoHS if $\geq 250V$ B = X7R RoHS if $\geq 250V$ RN = COG/NPO RoHS RB = X7R RoHS S = X8R not RoHS compliant	Value in Picofarads. Two significant figures, followed by number of zeros: 123 = 12,000pF	F = $\pm 1\%$ * G = $\pm 2\%$ * J = $\pm 5\%$ K = $\pm 10\%$ M = $\pm 20\%$ *COG parts only	Two significant figures, followed by number of zeros: 501 = 500V	LE, LB, LD, LR, LQ* = Yellow conformal coated LO = without any coating * Product and Case size dependent	No suffix = Bulk A = Ammo pack 2K/pack T = Tape & Reel 4K/Reel	R = RoHS Compliant (Tin Plating) None = Tin/Lead Plating

NOVACAP ORDERING INFORMATION — RADIAL LEADED — HIGH TEMPERATURE

2520	E	563	K	501	LG	W	R
Size	Dielectric	Capacitance	Tolerance	Voltage-VDCW	Lead Styles	Packing	RoHS
See charts	D = 200°C COG/NPO E = 200°C Class II	Value in Picofarads. Two significant figures, followed by number of zeros: 563 = 56,000pF	F = $\pm 1\%$ * G = $\pm 2\%$ * J = $\pm 5\%$ K = $\pm 10\%$ M = $\pm 20\%$ *COG parts only	Two significant figures, followed by number of zeros: 501 = 500V	LC = Encapsulated LG = Black Epoxy Coated LO = without any coating	No suffix = Bulk W = Waffle pack	R = RoHS Compliant (Tin Plating) None = Tin/Lead Plating

SYFER ORDERING INFORMATION — RADIAL LEADED — STANDARD

8111M	100	0102	J	C	□□□	□□□	
Type No./ Size ref.	Voltage d.c.		Capacitance in picofarads (pF)	Capacitance tolerance	Dielectric Rel Release codes	Suffix code	Suffix code
	Value	Marking code					
8111M	050 = 50V	(C)	<10pF Insert a P for the decimal point as the second character. e.g., 8P20 = 8.2pF ≥10pF First digit is zero. Second and third digits are significant figures of capacitance code. Fourth digit is number of zeros e.g., 0101 = 100pF	<10pF D : $\pm 0.5pF$ F : $\pm 1.0pF$ ≥10pF J : $\pm 5\%$ K : $\pm 10\%$ M : $\pm 20\%$ ≥27pF G : $\pm 2\%$ (COG/NPO only)	C = COG/NPO (1B/CG; CG/BP) X = X7R (2R1) To Special Order B = 2X1 (BX) R = 2C1 (BZ)	Used for specific customer requirements.	C42 denotes RoHS compliant. A31 or A97 denote non-RoHS tin/lead wires. Suffix A97 for 8111 to 8141. Suffix A31 for 8151, 8161 and 8171.
8111N	063 = 63V	(D)					
8121M	100 = 100V	(E)					
8121N	200 = 200V	(F)					
8121T	250 = 250V	-					
8131M	500 = 500V	(Q)					
8131N	630 = 630V	-					
8131T	1K0 = 1kV	-					
8141M	1K2 = 1.2kV	-					
8141N	1K5 = 1.5kV	-					
8151M	2K0 = 2kV	-					
8151N	2K5 = 2.5kV	-					
8161M	3K0 = 3kV	-					
8161N	4K0 = 4kV	-					
8165M	5K0 = 5kV	-					
8171M	6K0 = 6kV	-					
	8K0 = 8kV	-					
	10K = 10kV	-					
	12K = 12kV	-					

Note: The voltage code may be replaced with the complete voltage (e.g., 1500V = 1K5V) at Syfer's discretion. Marking may be over both sides of the component as necessary.



Standard Radial Leaded Capacitors — 50V to 5kV

RoHS compliant interconnects, small case size, Radial Leaded capacitors available in C0G/NP0, X7R and X8R dielectrics. The conformal coating and lead mounting style provide a rugged configuration for optimum performance. Units exhibit high capacitance efficiency per kV rating and find application in commercial/industrial use up to 5kV, such as power supplies and voltage multiplier circuits. They are offered in bulk pack or taped form, Ref EIA-RS468, making them suitable for automatic insertion.

- For ordering information, see Novacap Standard and High Rel table on page 93.

DIMENSIONS — INCHES/MM

Lead Style		LE	LD	LR	LD	LQ	LD	LE	LB
Size		0805	0805	1206	1206	1206	1210	1812	2225
Wmax	inches: mm:	0.150 3.81	0.150 3.81	0.200 5.08	0.200 5.08	0.200 5.08	0.200 5.08	0.300 7.62	0.350 8.89
Hmax	inches: mm:	0.150 3.81	0.150 3.81	0.150 3.81	0.150 3.81	0.150 3.81	0.200 5.08	0.250 6.35	0.350 8.89
Tmax	inches: mm:	0.100 2.54	0.100 2.54	0.125 3.18	0.125 3.18	0.125 3.18	0.175 4.45	0.200 5.08	0.200 5.08
HSmax	inches: mm:	0.200 5.08	0.250 6.35	0.250 6.35	0.250 6.35	0.250 6.35	0.300 7.62	0.350 8.89	0.500 12.70
S	inches ± 0.02 : mm ± 0.51 :	0.100 2.54	0.200 5.08	0.100 2.54	0.200 5.08	0.250 6.35	0.200 5.08	0.200 5.08	0.200 5.08
WD	inches ± 0.02 : mm ± 0.51 :	0.020 0.51	0.020 0.51	0.020 0.51	0.020 0.51	0.020 0.51	0.020 0.51	0.025 0.64	0.025 0.64

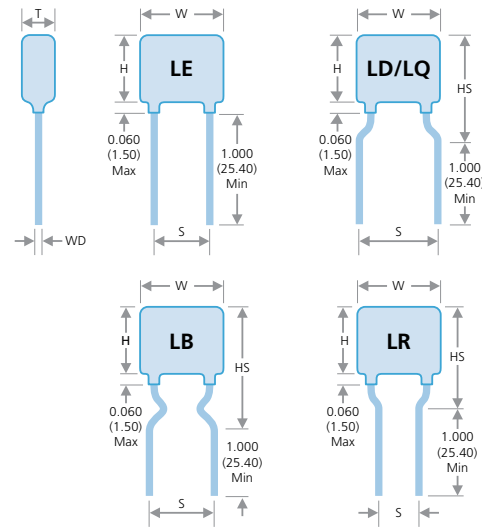

CAPACITANCE AND VOLTAGE SELECTION — COMMERCIAL RADIAL LEADED CAPACITORS

Size	0805			1206			1210			1812			2225		
Min cap.	10pF	120pF	120pF	10pF	120pF	220pF	10pF	120pF	330pF	100pF	150pF	220pF	100pF	470pF	1.0nF
Dielectric	C0G	X7R	X8R	C0G	X7R	X8R	C0G	X7R	X8R	C0G	X7R	X8R	C0G	X7R	X8R
50V	3.9nF	100nF	47nF	12nF	270nF	150nF	22nF	470nF	270nF	39nF	1.2μF	560nF	120nF	1.8μF	1.2μF
100V	3.9nF	68nF	33nF	10nF	180nF	100nF	18nF	330nF	180nF	27nF	820nF	390nF	82nF	1.5μF	1.0μF
250V	1.5nF	27nF	18nF	3.9nF	68nF	33nF	8.2nF	120nF	82nF	22nF	390nF	150nF	47nF	820nF	560nF
500V	820pF	12nF	5.6nF	1.8nF	22nF	15nF	4.7nF	56nF	39nF	12nF	150nF	56nF	27nF	330nF	150nF
1kV	470pF	2.7nF	•	1.0nF	6.8nF	•	2.2nF	15nF	•	8.2nF	47nF	•	15nF	100nF	•
2kV	•	•	•	390pF	1.0nF	•	820pF	2.2nF	•	2.7nF	6.8nF	•	3.9nF	15nF	•
3kV	•	•	•	•	•	•	•	•	•	1.2nF	2.7nF	•	1.8nF	5.6nF	•
4kV	•	•	•	•	•	•	•	•	•	820pF	1.2nF	•	1.0nF	1.5nF	•
5kV	•	•	•	•	•	•	•	•	•	•	•	•	560pF	1.0nF	•

Note: Parts in this range may be defined as dual use under export control legislation, and as such may be subject to export licence restrictions. Please refer to page 15 for more information on the dual-use regulations and contact the Sales Office for further information on specific part numbers.



Standard Radial Leaded Capacitors — 500V to 10kV

RoHS or Non-RoHS Radial Leaded Capacitors available in COG/NPO and X7R dielectrics with high voltage ratings from 500V. The conformal coating and lead mounting style provide a rugged configuration for optimum performance. Units exhibit high capacitance efficiency per kV rating and find application in commercial/industrial use up to 10kV, such as power supplies and voltage multiplier circuits. They are also offered without the conformal coating for less harsh environmental applications.

- For ordering information, see Novacap Standard and High Rel table on page 93.

DIMENSIONS — INCHES/MM

Lead Style		LE with conformal coating - LO without						
Size		1515	2520	3530	4540	5550	6560	7565
Wmax	inches:	0.250	0.400	0.500	0.600	0.700	0.800	0.900
	mm:	6.35	10.20	12.70	15.20	17.80	20.30	22.80
Hmax	inches:	0.250	0.350	0.450	0.550	0.650	0.750	0.850
	mm:	6.35	8.89	11.40	14.00	16.50	19.00	21.60
Tmax	inches:	0.200	0.250	0.350	0.400	0.400	0.400	0.400
	mm:	5.08	6.35	8.89	10.20	10.20	10.20	10.20
S	inches ± 0.02 :	0.170	0.280	0.380	0.480	0.580	0.680	0.780
	mm ± 0.51 :	4.32	7.10	9.65	12.20	14.70	17.30	19.80

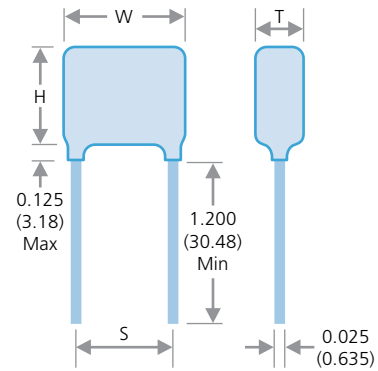

CAPACITANCE AND VOLTAGE SELECTION — STANDARD RADIAL LEADED CAPACITORS

Size	1515		2520		3530		4540		5550		6560		7565	
Min cap.	10pF	150pF	39pF	1.0nF	39pF	1.0nF	39pF	1.0nF	39pF	1.0nF	56pF	2.2nF	100pF	2.2nF
Dielectric	COG	X7R	COG	X7R	COG	X7R	COG	X7R	COG	X7R	COG	X7R	COG	X7R
500V	8.2nF	150nF	39nF	680nF	68nF	1.0μF	120nF	1.8μF	180nF	2.2μF	270nF	3.3μF	330nF	4.7μF
600V	6.8nF	120nF	22nF	390nF	39nF	680nF	82nF	1.5μF	150nF	2.2μF	220nF	2.7μF	270nF	3.9μF
800V	6.8nF	82nF	18nF	270nF	33nF	390nF	68nF	820nF	120nF	1.5μF	180nF	2.2μF	220nF	2.7μF
1kV	5.6nF	56nF	12nF	180nF	27nF	330nF	56nF	680nF	100nF	1.0μF	150nF	1.5μF	180nF	2.2μF
2kV	2.7nF	8.2nF	5.6nF	27nF	15nF	68nF	33nF	180nF	47nF	270nF	68nF	390nF	100nF	470nF
3kV	1.2nF	3.3nF	2.7nF	12nF	10nF	27nF	22nF	68nF	33nF	120nF	47nF	180nF	56nF	220nF
4kV	680pF	1.2nF	1.5nF	4.7nF	5.6nF	15nF	12nF	33nF	18nF	47nF	27nF	82nF	39nF	100nF
5kV	-	-	1.0nF	2.7nF	3.3nF	10nF	8.2nF	18nF	12nF	33nF	18nF	47nF	22nF	56nF
6kV	-	-	-	-	1.8nF	5.6nF	3.9nF	12nF	5.6nF	22nF	10nF	33nF	12nF	39nF
7kV	-	-	-	-	1.2nF	4.7nF	2.7nF	8.2nF	4.7nF	15nF	6.8nF	22nF	8.2nF	27nF
8kV	-	-	-	-	1.0nF	3.3nF	2.2nF	6.8nF	3.3nF	12nF	5.6nF	15nF	6.8nF	22nF
9kV	-	-	-	-	-	2.7nF	1.8nF	4.7nF	2.7nF	10nF	3.9nF	12nF	4.7nF	18nF
10kV	-	-	-	-	-	1.8nF	1.5nF	3.9nF	2.2nF	6.8nF	3.3nF	10nF	3.9nF	12nF

Note: Parts in this range may be defined as dual use under export control legislation, and as such may be subject to export licence restrictions. Please refer to page 15 for more information on the dual-use regulations and contact the Sales Office for further information on specific part numbers.



Standard Radial Leaded Capacitors — COG/NPO and X7R

Knowles produces a wide range of dipped radial leaded capacitors. These are available in rated voltages of 50V up to 6kV. Although our catalog range extends to 6kV, we are able to offer a capability for specials up to 12kV. Our larger case sizes and high voltage versions are particularly in demand, especially for mil/aero and medical power supply applications. Please contact the Sales Office to discuss any special requirements.

- High working voltage — up to 12kVdc
- Large case sizes
- RoHS compliant versions
- Tin-lead plated wire option to reduce tin whiskers (quote suffix A97 for 8111 to 8141 and A31 for 8151, 8161, 8171).
- For ordering information, see Syfer table on page 93.

		8111M	8111N	8121M	8121N	8121T	8131M	8131M T = 6.3mm	8131T	8141M	8151M	8151M T = 6.3mm	8161M	8161M T = 7.0mm	8171M	8171M T = 7.0mm
Min. cap values	COG/NPO	4.7pF	4.7pF	4.7pF	4.7pF	4.7pF	4.7pF	-	10pF	4.7pF	10pF	-	27pF	-	47pF	-
	X7R	100pF	100pF	100pF	100pF	330pF	100pF	-	150pF	100pF	470pF	-	1.0nF	-	1.8nF	-
50V/63V	COG/NPO	5.6nF	5.6nF	33nF	33nF	33nF	220nF	-	100nF	220nF	330nF	-	680nF	-	1.0µF	-
	X7R	220nF	220nF	1.0µF	1.0µF	1.0µF	3.3µF	-	2.2µF	4.7µF	10µF	-	15µF	-	22µF	-
100V	COG/NPO	2.2nF	2.2nF	18nF	18nF	18nF	82nF	-	47nF	82nF	270nF	-	470nF	-	680nF	-
	X7R	100nF	100nF	680nF	680nF	680nF	2.7µF	-	1.5µF	2.7µF	5.6µF	-	10µF	-	15µF	-
200V/ 250V	COG/NPO	1.0nF	1.0nF	8.2nF	8.2nF	8.2nF	47nF	68nF	22nF	47nF	120nF	180nF	270nF	330nF	390nF	560nF
	X7R	56nF	56nF	330nF	330nF	330nF	1.5µF	-	680nF	1.5µF	3.3µF	-	5.6µF	-	10µF	-
500V	COG/NPO	680pF	680pF	6.8nF	6.8nF	6.8nF	33nF	47nF	15nF	33nF	82nF	120nF	180nF	270nF	270nF	470nF
	X7R	15nF	15nF	150nF	150nF	150nF	820nF	-	330nF	820nF	1.0µF	-	1.8µF	-	3.3µF	-
630V	COG/NPO	560pF	560pF	3.9nF	3.9nF	3.9nF	22nF	39nF	10nF	22nF	68nF	100nF	120nF	180nF	220nF	390nF
	X7R	12nF	12nF	100nF	100nF	100nF	390nF	-	180nF	470nF	680nF	-	1.2µF	-	2.2µF	-
1kV	COG/NPO	180pF	180pF	2.2nF	2.2nF	2.2nF	18nF	27nF	6.8nF	18nF	47nF	82nF	82nF	150nF	150nF	270nF
	X7R	10nF	10nF	47nF	47nF	47nF	150nF	-	100nF	150nF	180nF	-	390nF	-	1.0µF	-
1.2kV	COG/NPO	120pF	120pF	1.5nF	1.5nF	1.5nF	12nF	22nF	4.7nF	12nF	33nF	56nF	68nF	100nF	100nF	180nF
	X7R	-	-	10nF	10nF	10nF	100nF	-	33nF	100nF	150nF	-	220nF	-	470nF	-
1.5kV	COG/NPO	82pF	82pF	820pF	820pF	820pF	6.8nF	12nF	2.7nF	6.8nF	22nF	39nF	39nF	68nF	68nF	120nF
	X7R	-	-	6.8nF	6.8nF	6.8nF	68nF	-	22nF	68nF	100nF	-	150nF	-	330nF	-
2kV	COG/NPO	39pF	39pF	390pF	390pF	390pF	4.7nF	6.8nF	1.5nF	4.7nF	10nF	18nF	22nF	39nF	39nF	68nF
	X7R	-	-	4.7nF	4.7nF	4.7nF	33nF	-	10nF	47nF	47nF	-	82nF	-	150nF	-
2.5kV	COG/NPO	-	-	220pF	220pF	220pF	2.2nF	3.9nF	820pF	2.2nF	6.8nF	12nF	12nF	22nF	22nF	39nF
	X7R	-	-	-	-	-	12nF	-	3.3nF	12nF	33nF	-	68nF	-	100nF	-
3kV	COG/NPO	-	-	150pF	150pF	150pF	1.8nF	2.7nF	560pF	1.8nF	4.7nF	8.2nF	10nF	18nF	15nF	27nF
	X7R	-	-	-	-	-	8.2nF	-	2.7nF	10nF	22nF	-	47nF	-	82nF	-
4kV	COG/NPO	-	-	-	-	-	820pF	1.5nF	270pF	820pF	1.8nF	3.3nF	4.7nF	6.8nF	8.2nF	15nF
	X7R	-	-	-	-	-	5.6nF	-	2.2nF	5.6nF	6.8nF	-	15nF	-	33nF	-
5kV	COG/NPO	-	-	-	-	-	560pF	1.0nF	180pF	560pF	1.5nF	2.2nF	2.7nF	4.7nF	5.6nF	10nF
	X7R	-	-	-	-	-	4.7nF	-	1.2nF	4.7nF	5.6nF	-	10nF	-	22nF	-
6kV	COG/NPO	-	-	-	-	-	390pF	680pF	120pF	390pF	1.0nF	1.5nF	1.8nF	3.3nF	3.9nF	6.8nF
	X7R	-	-	-	-	-	2.7nF	-	1.0nF	2.7nF	4.7nF	-	8.2nF	-	15nF	-
8kV	COG/NPO	-	-	-	-	-	-	-	-	-	150pF	-	330pF	-	680pF	-
	X7R	-	-	-	-	-	-	-	-	-	1.5nF	-	4.7nF	-	6.8nF	-
10kV	COG/NPO	-	-	-	-	-	-	-	-	-	100pF	-	180pF	-	470pF	-
	X7R	-	-	-	-	-	-	-	-	-	1.0nF	-	2.2nF	-	4.7nF	-
12kV	COG/NPO	-	-	-	-	-	-	-	-	-	68pF	-	120pF	-	220pF	-
	X7R	-	-	-	-	-	-	-	-	-	820pF	-	1.2nF	-	2.2nF	-
		8111M	8111N	8121M	8121N	8121T	8131M	8131M T = 6.3mm	8131T	8141M	8151M	8151M T = 6.3mm	8161M	8161M T = 7.0mm	8171M	8171M T = 7.0mm

Notes: 1) T = Maximum thickness.

2) Parts in this range may be defined as dual use under export control legislation as such may be subject to export licence restrictions.

Please refer to page 15 for more information on the dual-use regulations and contact the Sales Office for further information on specific part numbers.



Standard Radial Leaded Capacitors — Packaging Information

DIMENSIONS — RADIAL LEADED CAPACITORS

	Pattern	Width	Height	Thickness	Lead Space	Lead Diameter
		(X) max. mm (inches)	(Y) max. mm (inches)	(Z) max. mm (inches)	(S) mm (inches)	(d) mm (inches)
8111M	A	3.81 (0.15)	5.31 (0.21)	2.54 (0.10)	2.54 ±0.4 (0.1 ±0.016)	0.5 ±0.05 (0.02 ±0.002)
8111N	B	3.81 (0.15)	5.31 (0.21)	2.54 (0.10)	5.08 ±0.4 (0.2 ±0.016)	0.5 ±0.05 (0.02 ±0.002)
8121M	A	5.08 (0.20)	6.58 (0.26)	3.18 (0.125)	2.54 ±0.4 (0.1 ±0.016)	0.5 ±0.05 (0.02 ±0.002)
8121N	B	5.08 (0.20)	6.58 (0.26)	3.18 (0.125)	5.08 ±0.4 (0.2 ±0.016)	0.5 ±0.05 (0.02 ±0.002)
8121T	B	10.16 (0.40)	5.80 (0.23)	4.50 (0.18)	7.62 ±0.4 (0.30 ±0.016)	0.5 ±0.05 (0.02 ±0.002)
8131M	A	7.62 (0.30)	9.12 (0.36)	3.81/6.30 (0.15/0.25)	5.08 ±0.4 (0.2 ±0.016)	0.5 ±0.05 (0.02 ±0.002)
8131T	B	10.16 (0.40)	9.12 (0.36)	4.50 (0.18)	7.62 ±0.4 (0.30 ±0.016)	0.5 ±0.05 (0.02 ±0.002)
8141M	A	10.16 (0.40)	11.66 (0.46)	3.81 (0.15)	5.08 ±0.4 (0.2 ±0.016)	0.5 ±0.05 (0.02 ±0.002)
8151M	A	12.70 (0.50)	14.20 (0.56)	5.08/6.30 (0.20/0.25)	10.1 ±0.4 (0.4 ±0.016)	0.6 ±0.05 (0.025 ±0.002)
8161M	A	18.50 (0.73)	16.50 (0.65)	6.00/7.00 (0.24/0.28)	14.5 ±0.5 (0.57 ±0.02)	0.6 ±0.05 (0.025 ±0.002)
8165M	A	19.00 (0.75)	19.00 (0.75)	4.25 (0.17)	17.5 ±0.5 (0.67 ±0.02)	0.6 ±0.05 (0.025 ±0.002)
8171M	A	25.00 (0.98)	20.00 (0.79)	6.00/7.00 (0.24/0.28)	21.0 ±0.6 (0.83 ±0.024)	0.6 ±0.05 (0.025 ±0.002)

PATTERN A

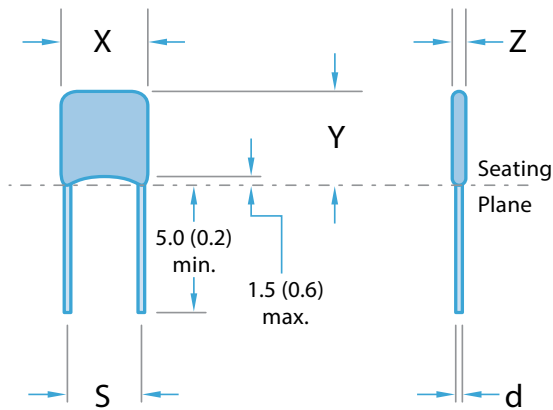

PATTERN B

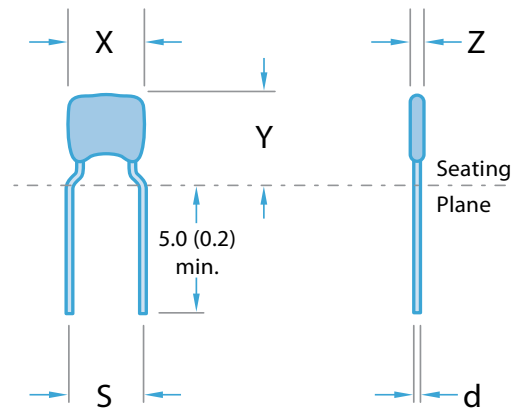

Note: Pattern A may be substituted with Pattern B at Knowles' discretion.

MARKING INFORMATION

All encapsulated capacitors are marked with: Capacitance value, tolerance, rated d.c. voltage, dielectric and, where size permits, the Syfer "S" logo.

EXAMPLE: 1000PF ±10% 50V 2X1 DIELECTRIC

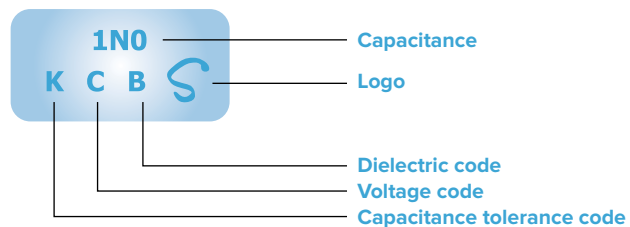

Note: Parts in this range may be defined as dual use under export control legislation as such may be subject to export licence restrictions. Please refer to page 15 for more information on the dual-use regulations and contact the Sales Office for further information on specific part numbers.

Radial Leaded Capacitors — Packaging Information

CROPPED LEADS

Cropped leads between 4.0 (0.157) and 30.0 (1.18) are available to special order. Some of the preferred codes are listed below, together with the appropriate suffix code.

Dimensions as for standard product except as specified.

Suffix code — AE3 All radial ranges	Suffix code — AE4 All radial ranges	Suffix code — AD7 All radial ranges	Suffix code — AD5 All radial ranges
Lead length (L) 6 ± 1 (0.236 ± 0.04) from seating plane	Lead length (L) 4 ± 1 (0.162 ± 0.04) from seating plane	Lead length (L) 5 ± 1 (0.2 ± 0.04) from seating plane	Lead length (L) 10 ± 1 (0.4 ± 0.04) from seating plane

Dimensions mm (inches)

SNAP IN LEADS

Various forms of snap in leads (preformed) are available to special order, some of the preferred suffix codes are listed below.

Dimensions as for standard product except as specified.

SUFFIX CODE — AD1

For PCB holes 0.9mm diameter
Types 8121N and 8131M

Dimensions

Y = 8121N 8 (0.315) Max
8131M 10 (0.394) Max
L = Min: 2.75 (0.108)
Max: 3.50 (0.138)

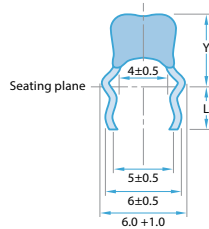

SUFFIX CODE — AD2

For PCB holes 1.2mm diameter
Types 8131M

Dimensions

Y = 10 (0.294) Max
L = Min: 2.75 (0.108)
Max: 3.50 (0.138)

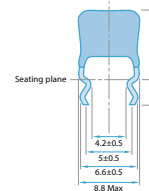

SUFFIX CODE — AD3

For PCB holes 1.2mm diameter
Types 8121N

Dimensions

Y = 8 (0.315) Max
L = Min: 2.75 (0.108)
Max: 3.50 (0.138)

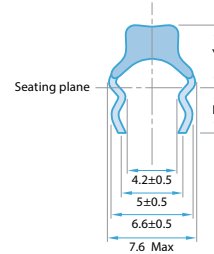

BANDOLIERY SUFFIX CODES

Dipped radial leaded with 2.54 and 5.08mm lead spacing can be supplied bandoliered on reels or in ammo boxes to special order. Some of the preferred suffix codes for bandoliered products are given below.

For bandoliered products, the minimum order quantity, pieces, is specified in the tables below; larger orders must be in multiples of this quantity.

DIPPED — STRAIGHT AND FORMED LEADS

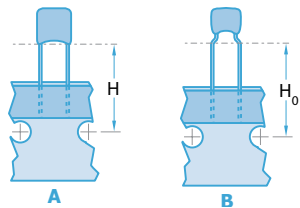

Suffix code

Product code	Lead style	Diagram	H	H ₀	Suffix code		
					Reel	AMMO pack	
8111M	Straight 2.54 crs	A	19±1	—	C01	C02	C11
8111M	Straight 2.54 crs	A	16±0.5	—	C30	C31	C32
8111N	Formed 5.08 crs	B	—	16±0.5	C01	C02	C11
8121M	Straight 2.54 crs	A	19±1	—	C01	C02	C11
8121M	Straight 2.54 crs	A	16±0.5	—	C30	C31	C32
8121N	Formed 5.08 crs	B	—	16±0.5	C01	C02	C11
8131M	Straight 5.08 crs	A	19±1	—	C01	C02	C11
8131M	Straight 5.08 crs	A	16±0.5	—	C30	C31	C32

Note: 8121T and 8131T available in bulk packaging only.

DIPPED — STAND-OFF LEAD FORM

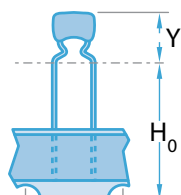

This style has been developed to provide a meniscus-free seating plane with a stress-relieving form for auto-insertion.

Product code	Lead style	Y max	H ₀	2,500pcs	1,000pcs	2,000pcs
8111N	Formed 5.08 crs	7.5	16±0.5	C12	C23	C22
8111N	Formed 5.08 crs	7.5	19±1	C13	C25	C24
8121N	Formed 5.08 crs	8.5	16±0.5	C12	C23	C22
8121N	Formed 5.08 crs	8.5	19±1	C13	C25	C24



Radial Leaded Capacitors — Packaging Information

For automatic insertion, the number of empty places in the tape per reel or fan-fold arrangement shall not exceed:

Three (3) missing components, when the component pitch is equivalent to one sprocket hole pitch.

One (1) missing component, when the component pitch is equivalent to two sprocket hole pitches or more.

At the beginning and end of a reel, the bandolier will exhibit at least 10 blank positions.

Minimum pull strength of product from tape = 5N.

Each reel/carton is provided with a label showing the: Manufacturer, product style, batch identification, quantity and date code.

Labeling with bar codes (code 39) is available on request.

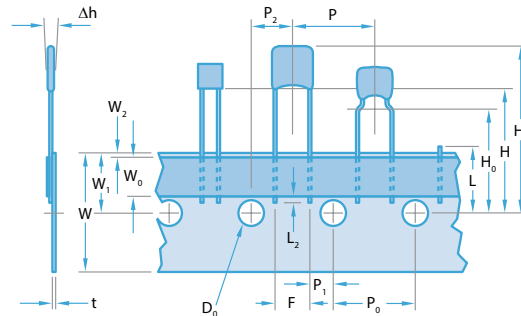

In accordance with IEC 60286 part 2.

DIMENSIONS MM (INCHES)

Description	Symbol	2.5mm lead space	5mm lead space	Tolerance
Lead wire diameter	d	0.5 (0.02), 0.6 (0.025)	0.5 (0.02), 0.6 (0.025)	±0.05 (0.002)
Component pitch	P	12.7 (0.5)	12.7 (0.5)	1.00 (0.04)
Feed hole pitch	P ₀	12.7 (0.5)	12.7 (0.5)	±0.30 (0.01)
Feed hole center to lead	P ₁	5.08 (0.2)	3.81 (0.15)	±0.70 (0.03)
Feed hole center to component	P ₂	6.35 (0.25)	6.35 (0.25)	±0.70 (0.03)
Lead spacing	F	2.54 (0.10)	5.08 (0.20)	+0.6 (0.02), -0.1 (0.004)
Component alignment	Δh	0	0	±2.00 (0.08)
Tape width	W	18.0 (0.70)	18.0 (0.70)	+1.00 (0.04), -0.50 (0.02)
Hold down tape width	W ₀	6.0 (0.23)	6.0 (0.23)	±0.30 (0.01)
Hole position	W ₁	9.0 (0.35)	9.0 (0.35)	±0.50 (0.02)
Hold down tape position	W ₂	0.50 (0.02)	0.50 (0.02)	Max
Height to seating plane from tape center (straight leads) (2)	H	16 (0.63) to 20 (0.79)	16 (0.63) to 20 (0.79)	As required
Height to seating plane from tape center (formed leads) (2)	H ₀	16 (0.63) to 20 (0.79)	16 (0.63) to 20 (0.79)	As required
Height to top of component from tape center	H ₁	32.2 (1.26)	32.2 (1.26)	Max
Feed hole diameter	D ₀	4.0 (0.16)	4.0 (0.16)	±0.20 (0.008)
Carrier tape plus adhesive tape thickness	t	0.7 (0.03)	0.7 (0.03)	±0.20 (0.008)
Carrier tape thickness	-	0.5 (0.02)	0.5 (0.02)	±0.10 (0.004)
Cut out component snipped lead length from tape center	L	11.0 (0.43)	11.0 (0.43)	Max
Lead wire protusion from hold down	L ₂	2.0 (0.08)	2.0 (0.08)	Max

BANDOLIERED REELS

The adhesive tape faces outward. The dispensing direction is as shown. For the protection of the components, a paper inlay is inserted between the windings of the bandolier. At the end of the bandolier, this paper inlay continues for at least a further two rotations.

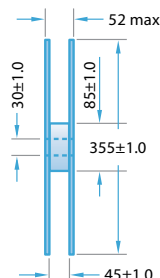
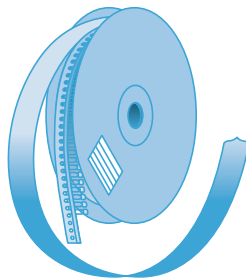

BANDOLIERED AMMO PACKING

2 carton sizes

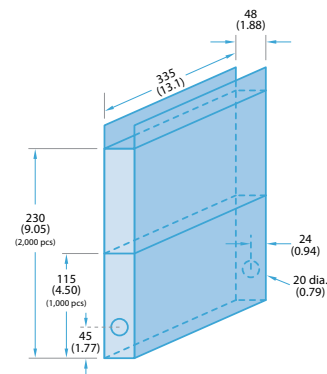

High Temperature Radial Leaded Capacitors — Epoxy Coated

A range of Radial Leaded capacitors available in sizes 1515 to 7565 designed to operate from -55°C to +200°C in COG/NPO and Class II dielectrics with voltage ratings of 25V to 4kV. These capacitors find typical application in harsh environments such as Oil Exploration and Automotive/Avionics engine compartment circuitry. The epoxy coating ensures environmental protection and a rugged configuration for optimum performance. They are also offered without the conformal coating for less harsh environmental applications.

- Capacitance tolerances: ±1%*, ±2%*, ±5%, ±10%, ±20% (*COG/NPO only)
- For ordering information, see Novacap High Temperature table on page 93.

DIMENSIONS — INCHES/MM

Lead Style LG with black epoxy coating — LO without

Size	1515	1812	2520	3530	4540	6560	7565
W							
inches:	0.250	0.300	0.370	0.470	0.570	0.770	0.870
mm:	6.35	7.62	9.40	11.90	14.50	19.60	22.10
H							
inches:	0.250	0.200	0.300	0.400	0.500	0.720	0.770
mm:	6.35	5.08	7.62	10.20	12.70	18.30	19.60
T							
inches:	0.190	0.160	0.240	0.310	0.360	0.360	0.360
mm:	4.83	4.06	6.10	7.87	9.14	9.14	9.14
S							
inches ±0.02:	0.170	0.200	0.280	0.380	0.480	0.680	0.780
mm ±0.508:	4.32	5.08	7.10	9.65	12.20	17.30	19.80

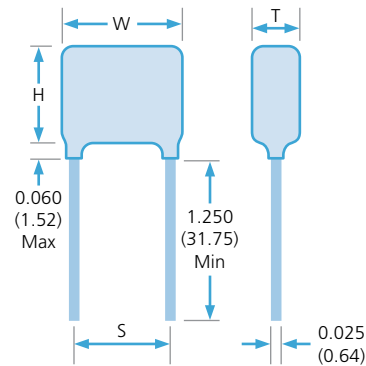

MAXIMUM CAPACITANCE VALUES — 200°C COG/NPO (D)/CLASS II (E) DIELECTRICS

Size	1515		1812		2520		3530		4540		6560		7565	
Min cap.	5pF	150pF	22pF	150pF	39pF	1.0nF	39pF	1.0nF	39pF	1.0nF	56pF	2.2nF	100pF	2.2nF
Dielectric	COG	Class II	COG	Class II	COG	Class II	COG	Class II	COG	Class II	COG	Class II	COG	Class II
25V	22nF	820nF	27nF	1.0µF	56nF	2.2µF	100nF	3.9µF	180nF	5.6µF	330nF	15µF	390nF	18µF
50V	18nF	680nF	22nF	680nF	56nF	1.8µF	82nF	2.7µF	150nF	4.7µF	270nF	12µF	330nF	15µF
100V	10nF	270nF	10nF	270nF	33nF	1.2µF	56nF	2.2µF	100nF	3.3µF	220nF	8.2µF	270nF	12µF
250V	3.9nF	82nF	6.8nF	100nF	15nF	270nF	33nF	560nF	56nF	1.2µF	120nF	2.7µF	150nF	3.9µF
500V	2.7nF	18nF	3.3nF	22nF	5.6nF	56nF	12nF	120nF	27nF	330nF	56nF	680nF	68nF	820nF
1kV	820pF	2.7nF	1.0nF	3.3nF	1.8nF	12nF	5.6nF	27nF	15nF	68nF	33nF	150nF	39nF	220nF
2kV	180pF	560pF	220pF	680pF	390pF	2.2nF	1.5nF	6.8nF	3.3nF	18nF	8.2nF	39nF	10nF	47nF
3kV	82pF	220pF	100pF	220pF	180pF	820pF	560pF	2.7nF	1.5nF	6.8nF	3.3nF	15nF	3.9nF	18nF
4kV	47pF	-	-	-	100pF	220pF	330pF	1.2nF	820pF	2.7nF	1.8nF	5.6nF	2.2nF	8.2nF



High Temperature Radial Leded Capacitors — Encapsulated

A range of Radial Leded capacitors available in sizes 1515 to 7565 designed to operate from -55°C to +200°C in COG/NP0 and Class II dielectrics. Voltage ratings of 25V to 500V. These capacitors find typical application in very harsh environments where isolation and protection of the device are required for optimum reliability. They are also offered without the molded case for less harsh environmental applications. Consult the Sales Office if your specific requirements exceed our catalog maximums (size, cap. value and voltage).

- Capacitance tolerances: $\pm 1\%$, $\pm 2\%$, $\pm 5\%$, $\pm 10\%$, $\pm 20\%$ (*COG/NP0 only)
- For ordering information, see Novacap High Temperature table on page 93.

DIMENSIONS — INCHES/MM

Lead Style LC with encapsulation

Size	1515	2520	3530	4540	5550	6560	7565
W inches ± 0.015 : mm ± 0.381 :	0.300 7.62	0.400 10.20	0.500 12.70	0.725 18.40	0.795 20.20	0.925 23.50	1.125 28.60
H inches ± 0.015 : mm ± 0.51 :	0.300 7.62	0.400 10.20	0.500 12.70	0.500 12.70	0.745 18.90	0.750 19.00	0.750 19.00
T inches ± 0.015 : mm ± 0.51 :	0.150 3.81	0.200 5.08	0.265 6.73	0.325 8.26	0.370 9.40	0.350 8.89	0.375 9.52
S inches ± 0.02 : mm ± 0.508 :	0.170 4.32	0.280 7.10	0.380 9.65	0.480 12.20	0.580 14.70	0.680 17.30	0.780 19.80

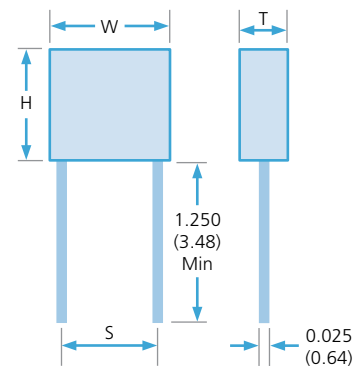

MAXIMUM CAPACITANCE VALUES — 200°C COG/NP0 (D)/CLASS II (E) DIELECTRICS

Size	1515		2520		3530		4540		5550		6560		7565	
Min cap.	3.3pF	220pF	39pF	1.0nF	39pF	1.0nF	39pF	1.0nF	39pF	1.0nF	56pF	2.2nF	100pF	2.2nF
Dielectric	COG	Class II	COG	Class II	COG	Class II	COG	Class II	COG	Class II	COG	Class II	COG	Class II
25V	18nF	560nF	56nF	2.2 μ F	100nF	3.9 μ F	180nF	5.6 μ F	220nF	10 μ F	330nF	15 μ F	390nF	18 μ F
50V	15nF	390nF	56nF	1.5 μ F	82nF	2.7 μ F	150nF	4.7 μ F	180nF	6.8 μ F	270nF	12 μ F	330nF	15 μ F
100V	5.6nF	120nF	27nF	820nF	56nF	1.8 μ F	100nF	3.3 μ F	150nF	5.6 μ F	220nF	8.2 μ F	270nF	10 μ F
250V	3.9nF	39nF	12nF	180nF	27nF	560nF	56nF	1.2 μ F	82nF	2.2 μ F	120nF	2.7 μ F	150nF	3.9 μ F
500V	1.5nF	8.2nF	5.6nF	39nF	12nF	82nF	27nF	220nF	39nF	330nF	56nF	470nF	82nF	680nF



Surface Mount EMI Filters — E01 and E07 Ranges



The E01 and E07 ranges of feedthrough MLCC chip "C" filters are 3-terminal chip devices designed to offer reduced inductance compared to conventional MLCCs when used in signal line filtering. The filtered signal passes through the chip internal electrodes and the noise is filtered to the grounded side contacts, resulting in reduced length noise transmission paths.

Available in COG/NP0 (1B) and X7R (2R1) dielectrics, with current ratings of 300mA, 1A, 2A, 3A and voltage ratings of 25Vdc to 200Vdc. Also available with FlexiCap™ termination, which is strongly recommended for new designs.

Commonly used in automotive applications, a range qualified to AEC-Q200 is also available.

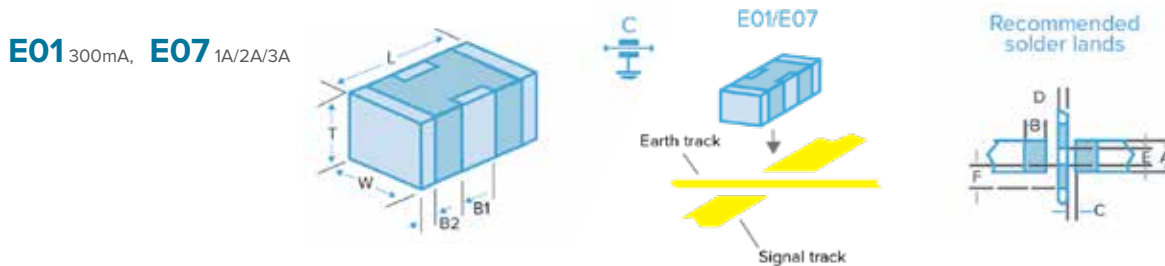

DIMENSIONS

	0805	1206	1806	1812
L	2.0 ± 0.3 (0.079 ± 0.012)	3.2 ± 0.3 (0.126 ± 0.012)	4.5 ± 0.35 (0.177 ± 0.014)	4.5 ± 0.35 (0.177 ± 0.014)
W	1.25 ± 0.2 (0.049 ± 0.008)	1.6 ± 0.2 (0.063 ± 0.008)	1.6 ± 0.2 (0.063 ± 0.008)	3.2 ± 0.3 (0.126 ± 0.012)
T	1.0 ± 0.15 (0.039 ± 0.006)	1.1 ± 0.2 (0.043 ± 0.008)	1.1 ± 0.2 (0.043 ± 0.008)	2.0 ± 0.3 (0.079 ± 0.012)
B1	0.60 ± 0.2 (0.024 ± 0.008)	0.95 ± 0.3 (0.037 ± 0.012)	1.4 ± 0.3 (0.055 ± 0.012)	1.45 ± 0.35 (0.055 ± 0.014)
B2	0.3 ± 0.15 (0.012 ± 0.006)	0.5 ± 0.25 (0.02 ± 0.01)	0.5 ± 0.25 (0.02 ± 0.01)	0.75 ± 0.25 (0.03 ± 0.01)

	0805	1206	1806	1812
A	0.95 (0.037)	1.20 (0.047)	1.2 (0.047)	2.65 (0.104)
B	0.90 (0.035)	0.90 (0.035)	1.40 (0.055)	1.40 (0.055)
C	0.30 (0.012)	0.60 (0.024)	0.80 (0.031)	0.80 (0.031)
D	0.40 (0.016)	0.80 (0.031)	1.40 (0.055)	1.40 (0.055)
E	0.75 (0.030)	1.0 (0.039)	1.0 (0.039)	2.05 (0.080)
F	0.56 (0.022)	0.70 (0.028)	0.70 (0.028)	1.08 (0.043)

Notes: 1) All dimensions mm (inches). 2) Pad widths less than chip width gives improved mechanical performance. 3) The solder stencil should place 4 discrete solder pads. The unprinted distance between ground pads is shown as dim E. 4) Insulating the earth track underneath the filters is acceptable and can help avoid displacement of filter during soldering but can result in residue entrapment under the chip.

STANDARD RANGE (E01, E07) — CAPACITANCE VALUES

TYPE		E01			E07			
Chip Size		0805	1206	1806	0805	1206	1806	1812
Max Current		300mA	300mA	300mA	1A	2A	2A	2A
Rated Voltage	Dielectric	Minimum and maximum capacitance values						
25Vdc	COG/NP0 (1B)	180pF - 1.5nF	560pF - 3.9nF	820pF - 4.7nF	180pF - 1.5nF	560pF - 3.9nF	820pF - 4.7nF	-
	X7R (2R1)	470pF - 100nF	5.6nF - 330nF	3.9nF - 560nF	820pF - 100nF	10nF - 330nF	22nF - 560nF	560nF - 1.8µF
50Vdc	COG/NP0 (1B)	22pF - 820pF	22pF - 3.3nF	22pF - 3.9nF	10pF - 220pF	22pF - 1nF	100pF - 1.5nF	-
	X7R (2R1)	560pF - 68nF	4.7nF - 220nF	3.3nF - 330nF	1nF - 68nF	10nF - 220nF	22nF - 330nF	330nF - 1.5µF
100Vdc	COG/NP0 (1B)	22pF - 560pF	22pF - 2.2nF	22pF - 3.3nF	10pF - 120pF	22pF - 560pF	100pF - 680pF	-
	X7R (2R1)	560pF - 27nF	1.8nF - 100nF	3.3nF - 180nF	1nF - 27nF	10nF - 100nF	22nF - 180nF	180nF - 820nF
200Vdc	COG/NP0 (1B)	-	560pF - 1.2nF	56pF - 1nF	-	15pF - 180pF	56pF - 470pF	-
	X7R (2R1)	-	2.7nF - 56nF	3.9nF - 100nF	-	12nF - 56nF	22nF - 100nF	100nF - 270nF

Note: E07 25Vdc COG/NP0 (1B) 1206 and 1806 ranges in green, have a maximum current of 1A.



Surface Mount EMI Filters — E01 and E07 Ranges



AEC-Q200 RANGE (E01, E07) — CAPACITANCE VALUES

TYPE		E01			E07		
Chip Size		0805	1206	1806	0805	1206	1806
50V	C0G/NPO (1B)	22pF - 820pF	22pF - 1nF	22pF - 2.2nF	10pF - 220pF	22pF - 1nF	100pF - 1.5nF
	X7R (2R1)	560pF - 47nF	4.7nF - 100nF	3.3nF - 200nF	1nF - 47nF	10nF - 100nF	22nF - 200nF
100V	C0G/NPO (1B)	22pF - 560pF	22pF - 1nF	22pF - 2.2nF	10pF - 120pF	22pF - 560pF	100pF - 680pF
	X7R (2R1)	560pF - 15nF	1.8nF - 15nF	3.3nF - 68nF	1nF - 15nF	10nF - 15nF	22nF - 68nF

Notes: Blue background = AEC-Q200. For some lower capacitance parts, higher voltage rated parts may be supplied.

OPEN BOARD INSERTION LOSS PERFORMANCE IN 50Ω SYSTEM

OPEN BOARD PERFORMANCE

Cap.	0.1MHz	1MHz	10MHz	100MHz	1GHz	Resonance Freq (MHz) approx.
10pF	0	0	0	0	7.5	2200
22pF	0	0	0	0	16	1600
33pF	0	0	0	1	22	1350
47pF	0	0	0	2	28	1150
68pF	0	0	0	3	41	900
100pF	0	0	0	5	28	800
150pF	0	0	0	8	24	700
220pF	0	0	0	12	20	600
330pF	0	0	1	15	20	500
470pF	0	0	2	18	20	425
560pF	0	0	3	20	20	350
680pF	0	0	4	22	20	300
820pF	0	0	5	24	20	260
1nF	0	0	7	27	20	220
1.5nF	0	0	9	31	20	200
2.2nF	0	0	12	34	20	170
3.3nF	0	1	14	39	20	135
4.7nF	0	2	18	46	20	110
6.8nF	0	3	21	50	20	90
10nF	0	5	24	48	20	80
15nF	0	8	27	45	20	65
22nF	0	12	31	43	20	56
33nF	1	14	34	40	20	40
47nF	2	17	38	40	20	34
68nF	4	20	41	40	20	30
100nF	5	24	45	40	20	28
150nF	8	26	48	40	20	24
220nF	10	30	52	40	20	17
330nF	13	33	55	40	20	15.5
470nF	16	36	60	40	20	14
560nF	18	39	65	40	20	12

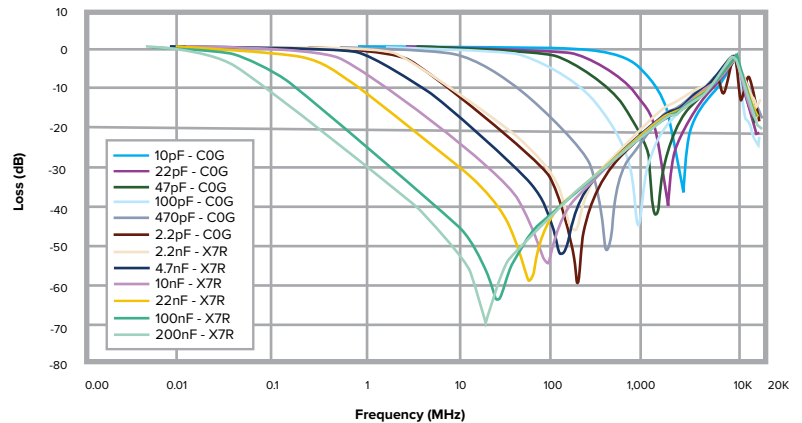

ORDERING INFORMATION — E01 AND E07 FEEDTHROUGH CAPACITORS

Chip Size	Termination	Voltage	Capacitance in Picofarads (pF)	Tolerance	Dielectric	Packaging	Type
1206 Y 100 0103 M X T E07	J = Nickel Barrier (Tin) Y = FlexiCap™ (Tin - X7R (2R1) only) A = (Tin/Lead) Not RoHS compliant. H = FlexiCap™ (Tin/Lead) Not RoHS compliant.	025 = 25V 050 = 50V 100 = 100V 200 = 200V	First digit is 0. Second and third digits are significant figures of capacitance code. The fourth digit is number of zeros following. Example: 0103 = 10000pF.	M = ±20%	A = C0G/NPO (1B) to AEC-Q200 E = X7R (2R1) to AEC-Q200 C = C0G/NPO (1B) X = X7R (2R1)	T = 178mm (7") reel R = 330mm (13") reel B = Bulk	E01 E07

Notes: A, Y and H terminations are not available for dielectric codes A and C.

J and A terminations are not available for dielectric code E.

Please contact your Knowles Precision Devices sales office for any special requirements.

REELED QUANTITIES

	0805	1206	1806	1812
178mm (7") reel	3,000	2,500	2,500	500
330mm (13") reel	12,000	10,000	10,000	2,000

Surface Mount EMI Filters — E03 X2Y Integrated Passive Components



The X2Y Integrated Passive Component is a 3-terminal EMI chip device.

When used in balanced line applications, the revolutionary design provides simultaneous line-to-line and line-to-ground filtering, using a single ceramic chip. In this way, differential and common mode filtering are provided in one device.

For unbalanced applications, it provides ultra-low ESL (equivalent series inductance). Capable of replacing two or more conventional devices, it is ideal for balanced and unbalanced lines, twisted pairs and dc motors, in automotive, audio, sensor and other applications.

Available in sizes from 0805 to 1812, these filters can prove invaluable in meeting stringent EMC demands.

Dielectric: X7R (2R1) or COG/NP0 (1B)	Capacitance measurement: At 1,000-hr point	Temperature rating: -55°C to +125°C	Dielectric withstand voltage: ≤200V 2.5 times rated Volts for 5 secs. 500V 1.5 times rated Volts for 5 secs. Charging current limited to 50mA Max.
Electrical configuration: Multiple capacitance	Typical capacitance matching: Better than 5% (down to 1% available on request)	Insulation resistance: 100GΩ or 1000s (whichever is the least)	

STANDARD RANGE (E03) — CAPACITANCE VALUES

TYPE		E03			
Chip Size		0805	1206	1410	1812
Rated Voltage	Dielectric				
	COG/NP0 (1B)	560pF - 820pF	1.8nF - 3.3nF	6.8nF - 8.2nF	12nF - 15nF
25Vdc	X7R (2R1)	56nF - 68nF	-	470nF - 470nF	820nF - 820nF
	COG/NP0 (1B)	390pF - 470pF	1.2nF - 1.5nF	4.7nF - 5.6nF	8.2nF - 10nF
50Vdc	X7R (2R1)	18nF - 47nF	56nF - 220nF	180nF - 400nF	2.7nF - 680nF
	COG/NP0 (1B)	10pF - 330pF	22pF - 1nF	100pF - 3.9nF	820pF - 6.8nF
100Vdc	X7R (2R1)	470pF - 15nF	1.5nF - 47nF	4.7nF - 150nF	2.7nF - 330nF
	COG/NP0 (1B)	-	22pF - 1nF	100pF - 3.3nF	820pF - 5.6nF
200Vdc	X7R (2R1)	-	820pF - 33nF	1.2nF - 120nF	2.7nF - 220nF
	COG/NP0 (1B)	-	-	-	820pF - 3.9nF
500Vdc	X7R (2R1)	-	-	-	2.7nF - 100nF

	0805	1206	1410	1812
L	2.0 ± 0.3 (0.079 ± 0.012)	3.2 ± 0.3 (0.126 ± 0.012)	3.6 ± 0.3 (0.14 ± 0.012)	4.5 ± 0.35 (0.177 ± 0.014)
W	1.25 ± 0.2 (0.049 ± 0.008)	1.6 ± 0.2 (0.063 ± 0.008)	2.5 ± 0.3 (0.1 ± 0.012)	3.2 ± 0.3 (0.126 ± 0.012)
T	1.0 ± 0.15 (0.039 ± 0.006)	1.1 ± 0.2 (0.043 ± 0.008)	2.0 max. (0.08 max.)	2.1 max. (0.083 max.)
B1	0.50 ± 0.25 (0.020 ± 0.010)	0.95 ± 0.3 (0.037 ± 0.012)	1.20 ± 0.3 (0.047 ± 0.012)	1.45 ± 0.35 (0.055 ± 0.014)
B2	0.3 ± 0.15 (0.012 ± 0.006)	0.5 ± 0.25 (0.02 ± 0.01)	0.5 ± 0.25 (0.02 ± 0.01)	0.75 ± 0.25 (0.03 ± 0.01)

Note: For some lower capacitance parts, higher voltage rated parts may be supplied.

AEC-Q200 RANGE (E03 X7R BME AEC) — CAPACITANCE VALUES

Chip Size	0805		1206		1410		1812	
	Min	Max	Min	Max	Min	Max	Min	Max
50V	680pF	47nF	1.0nF	180nF	180nF	270nF	2.7nF	470nF
100V	680pF	15nF	1.0nF	47nF	4.7nF	150nF	2.7nF	270nF
200V	-	-	1.0nF	39nF	1.2nF	120nF	2.7nF	220nF
500V	-	-	-	-	-	-	2.7nF	100nF

Note: Blue background = AEC-Q200.

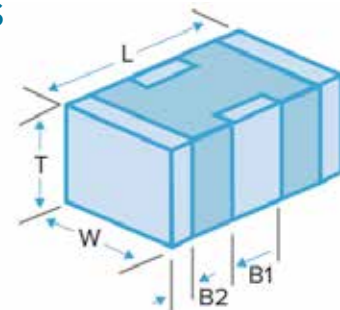

Surface Mount EMI Filters — E03 X2Y Integrated Passive Components

Recommended solder lands

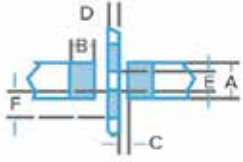

	0805	1206	1410	1812
A	0.95 (0.037)	1.2 (0.047)	2.05 (0.08)	2.65 (0.104)
B	0.9 (0.035)	0.9 (0.035)	1.0 (0.040)	1.4 (0.055)
C	0.3 (0.012)	0.6 (0.024)	0.7 (0.028)	0.8 (0.031)
D	0.4 (0.016)	0.8 (0.031)	0.9 (0.035)	1.4 (0.055)
E	0.75 (0.030)	1.0 (0.039)	1.85 (0.071)	2.05 (0.080)
F	0.56 (0.022)	0.7 (0.028)	0.79 (0.031)	1.08 (0.043)

COMPONENT ADVANTAGES DISADVANTAGES APPLICATIONS

COMPONENT	ADVANTAGES	DISADVANTAGES	APPLICATIONS
Chip capacitor	<ul style="list-style-type: none"> Industry standard 	<ul style="list-style-type: none"> Requires 1 per line High inductance Capacitance matching problems 	<ul style="list-style-type: none"> Bypass Low frequency
3-Terminal feedthrough	<ul style="list-style-type: none"> Feedthrough Lower inductance 	<ul style="list-style-type: none"> Current limited 	<ul style="list-style-type: none"> Feedthrough Unbalanced lines High frequency
Syfer X2Y Integrated Passive Component	<ul style="list-style-type: none"> Very low inductance Replaces 2 (or 3) components Negates the effects of temperature, voltage and aging Provides both common mode and differential mode attenuation Can be used on balanced and unbalanced lines 	<ul style="list-style-type: none"> Care must be taken to optimize circuit design 	<ul style="list-style-type: none"> Bypass Balanced lines High frequency DC electric motors Unbalanced lines Audio amplifiers CANBUS

FILTERING APPLICATION

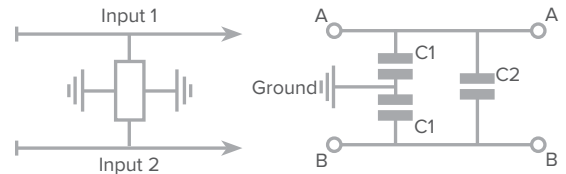

DECOUPLING APPLICATION

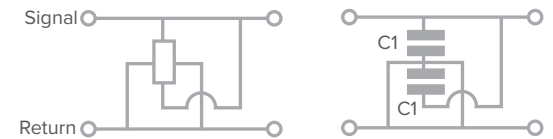

FILTERING APPLICATION

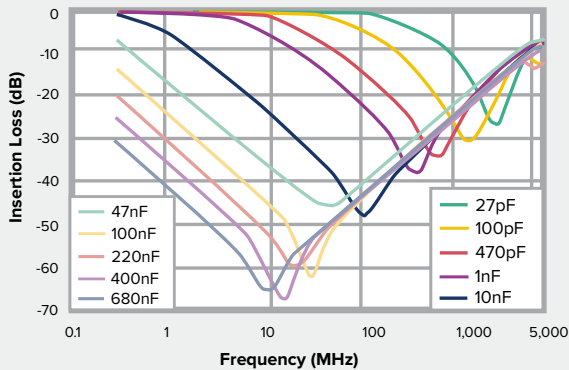

DECOUPLING APPLICATION

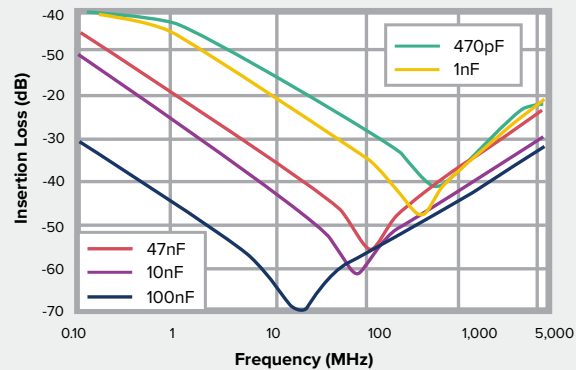

ORDERING INFORMATION — X2Y IPC RANGE

Chip Size	Termination	Voltage	Capacitance in Picofarads (pF) C1	Tolerance	Dielectric	Packaging	Type
0805 1206 1410 1812	J = Nickel Barrier (Tin) Y = FlexiCap™ (Tin - X7R (2R1) only) A = (Tin/Lead) H = FlexiCap™ (Tin/Lead) Not RoHS compliant.	025 = 25V 050 = 50V 100 = 100V 200 = 200V 500 = 500	First digit is 0. Second and third digits are significant figures of capacitance code. The fourth digit is number of zeros following Example: 0334 = 330nF. Note: C1 = 2C2	M = ±20% (Tighter tolerances may be available on request).	A = COG/NP0 (1B) to AEC-Q200 E = X7R (2R1) to AEC-Q200 C = COG/NP0 (1B) X = X7R (2R1)	T = 178mm (7") reel R = 330mm (13") reel B = Bulk	X2Y Integrated Passive Component

REELED QUANTITIES

	178mm (7") reel	330mm (13") reel
0805	3,000	12,000
1206	2,500	10,000
1410	2,000	8,000
1812	500	2,000

Notes: 1) A, Y and H terminations are not available for dielectric codes A and C. 2) J and A terminations are not available for dielectric code E.
3) Please contact your Knowles Precision Devices sales office for any special requirements.

Our Other Products

Knowles Capacitors designs, manufactures and sells special electronic components. Our products are used in military, space, telecom infrastructure, medical and industrial applications where function and reliability are crucial.

Air Capacitors

Discoidal Capacitors

EMI Filters

Feedthrough EMI Filters

Gain Equalizers

Half-Turn Trimmers

Hi-Cap Capacitors

Hi-Rel Products

Hi-Rel and Specialty Products

Lead Capacitors

Loaded Capacitors

Opti-Cap Capacitors

Planar Arrays

Pulse Capacitors

Special Discrete Filters

Special Filters

Specialty Products

Stacked Chips

Trimmers

Trimmer Capacitors

Varistor Filters

X8R Capacitors

250Vac Chips

500Vac X7R Chips

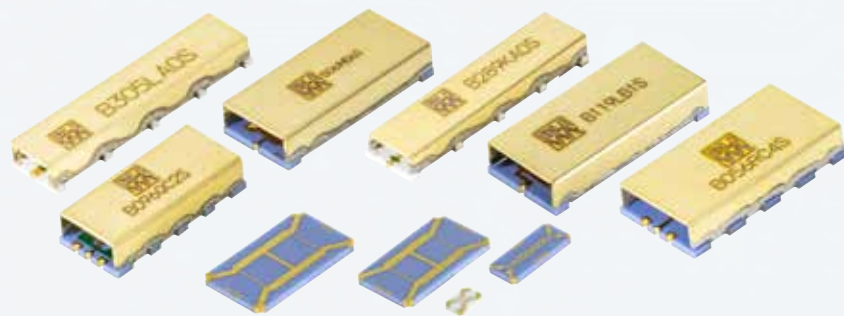

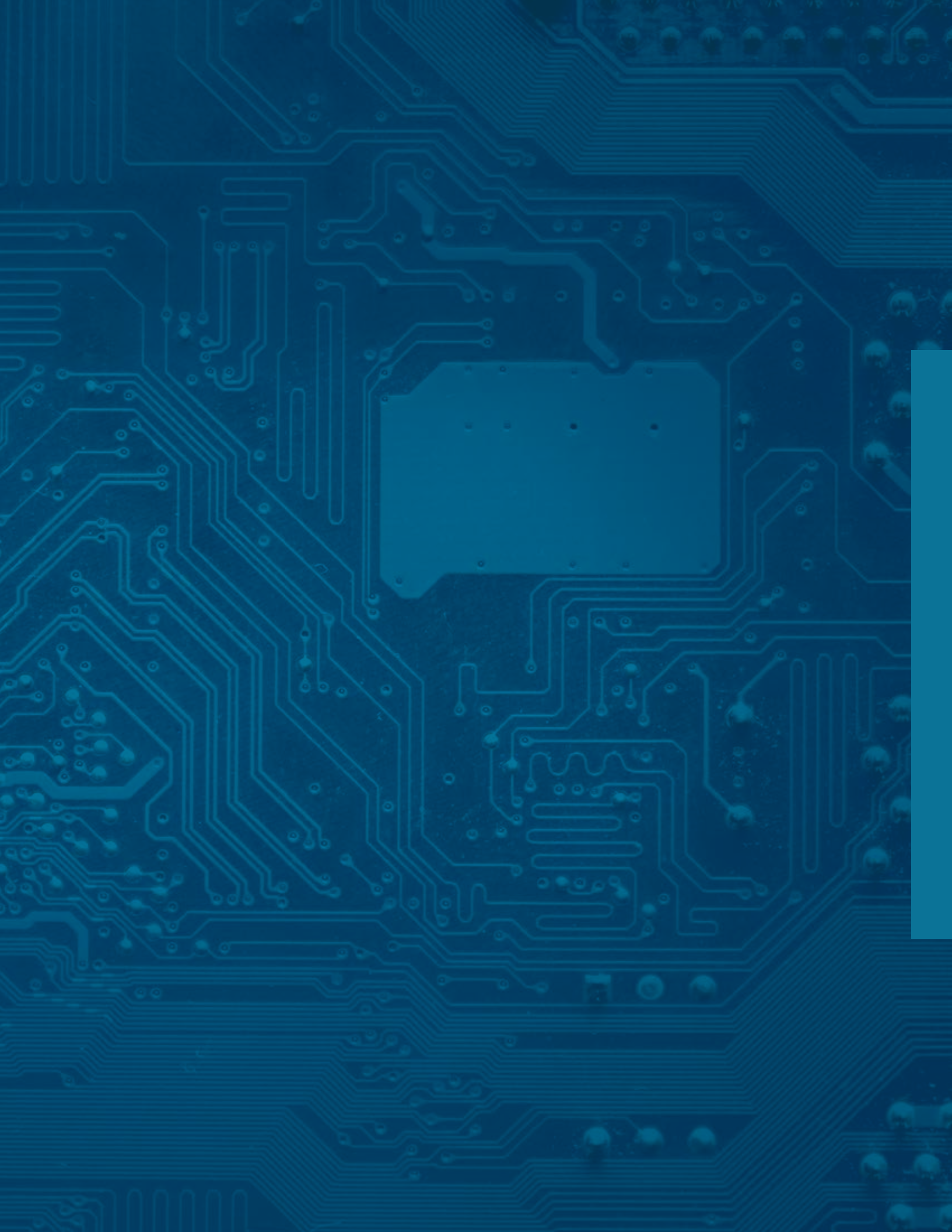



Scan here
to follow us on WeChat

Asian Sales Office

T: +86 512 62588258

F: +86 512 62589258

E: KPD-Asia-sales@knowles.com

European Sales Office

T: +44 1603 723300

F: +44 1603 723301

E: KPD-Europe-sales@knowles.com

North American Sales Office

T: +1 661 295 5920

F: +1 661 295 5928

T: +1 315 655 8710

F: +1 315 655 0445

E: KPD-NA-sales@knowles.com

01 24 R/11

Mouser Electronics

Authorized Distributor

Click to View Pricing, Inventory, Delivery & Lifecycle Information:

Knowles:

[0402J200P600BCT](#) [0402J2500100KCT](#) [0402J2500330GCT](#) [0402J2500391JXT](#) [0402J2500560MXT](#)
[0402J2501P20HCT](#) [0402J2501P50HCT](#) [0402J2502P20BCT](#) [0402J2503P30HCT](#) [0402J2503P90BCT](#)
[0402J2508P20HCT](#) [0402Y0250103JXT](#) [0402Y0250121JCT](#) [0402Y0250151KXT](#) [0402Y0250221FCT](#)
[0402Y0250221JXT](#) [0402Y0250272JXT](#) [0402Y0250470FCT](#) [0402Y0250470KCT](#) [0402Y0250560KCT](#)
[0402Y0250561JXT](#) [0402Y0250561KXT](#) [0402Y0250562JXT](#) [0402Y0250820JCT](#) [0402Y0250820KXT](#)
[0402Y0251P20CCT](#) [0402Y0251P50BCT](#) [0402Y0251P80DCT](#) [0402Y025P200HCT](#) [0402Y025P700BCT](#)
[0402Y025P700HCT](#) [0402Y025P800DCT](#) [0402Y0500102KXT](#) [0402Y0500120FCT](#) [0402Y0500121KXT](#)
[0402Y0500151KCT](#) [0402Y0500220GCT](#) [0402Y0500222MXT](#) [0402Y0500330KCT](#) [0402Y0500332MXT](#)
[0402Y0500470FCT](#) [0402Y0500470JXT](#) [0402Y0500470MXT](#) [0402Y0500471MXT](#) [0402Y0500472MXT](#)
[0402Y0500821JXT](#) [0402Y0501P00BCT](#) [0402Y0501P80DCT](#) [0402Y0502P20DCT](#) [0402Y0502P70BCT](#)
[0402Y0504P70DCT](#) [0402Y0505P60CCT](#) [0402Y0506P80BCT](#) [0402Y0506P80CCT](#) [0402Y050P500HCT](#)
[0402Y0630120KCT](#) [0402Y0630121JXT](#) [0402Y0630180GCT](#) [0402Y0630221GCT](#) [0402Y0630222JXT](#)
[0402Y0630332MXT](#) [0402Y0630470FCT](#) [0402Y0630470KCT](#) [0402Y0630471JXT](#) [0402Y0630471MXT](#)
[0402Y0630680FCT](#) [0402Y0630681JXT](#) [0402Y0631P00BCT](#) [0402Y0631P00CCT](#) [0402Y0631P80BCT](#)
[0402Y0633P30BCT](#) [0402Y0633P90CCT](#) [0402Y0636P80BCT](#) [0402Y0636P80HCT](#) [0402Y0638P20DCT](#)
[0402Y063P600BCT](#) [0402Y063P700CCT](#) [0402Y1000102KXT](#) [0402Y1000180GCT](#) [0402Y1000220JCT](#)
[0402Y1000330JCT](#) [0402Y1000391JXT](#) [0402Y1000470KXT](#) [0402Y1000471KXT](#) [0402Y1001P00DCT](#)
[0402Y1002P20BCT](#) [0402Y1002P20HCT](#) [0402Y1002P70DCT](#) [0402Y1002P70HCT](#) [0402Y1003P90BCT](#)
[0402Y1005P60BCT](#) [0402Y1005P60CCT](#) [0402Y1005P60HCT](#) [0402Y100P600CCT](#) [0402Y100P900BCT](#)
[0402Y2000151KXT](#) [0402Y2000180GCT](#) [0402Y2000180JCT](#) [0402Y2000271JXT](#) [0402Y2000681KXT](#)