



Low Profile



Isolated



OCP

Safety
Approvals

MUS, MUW-series

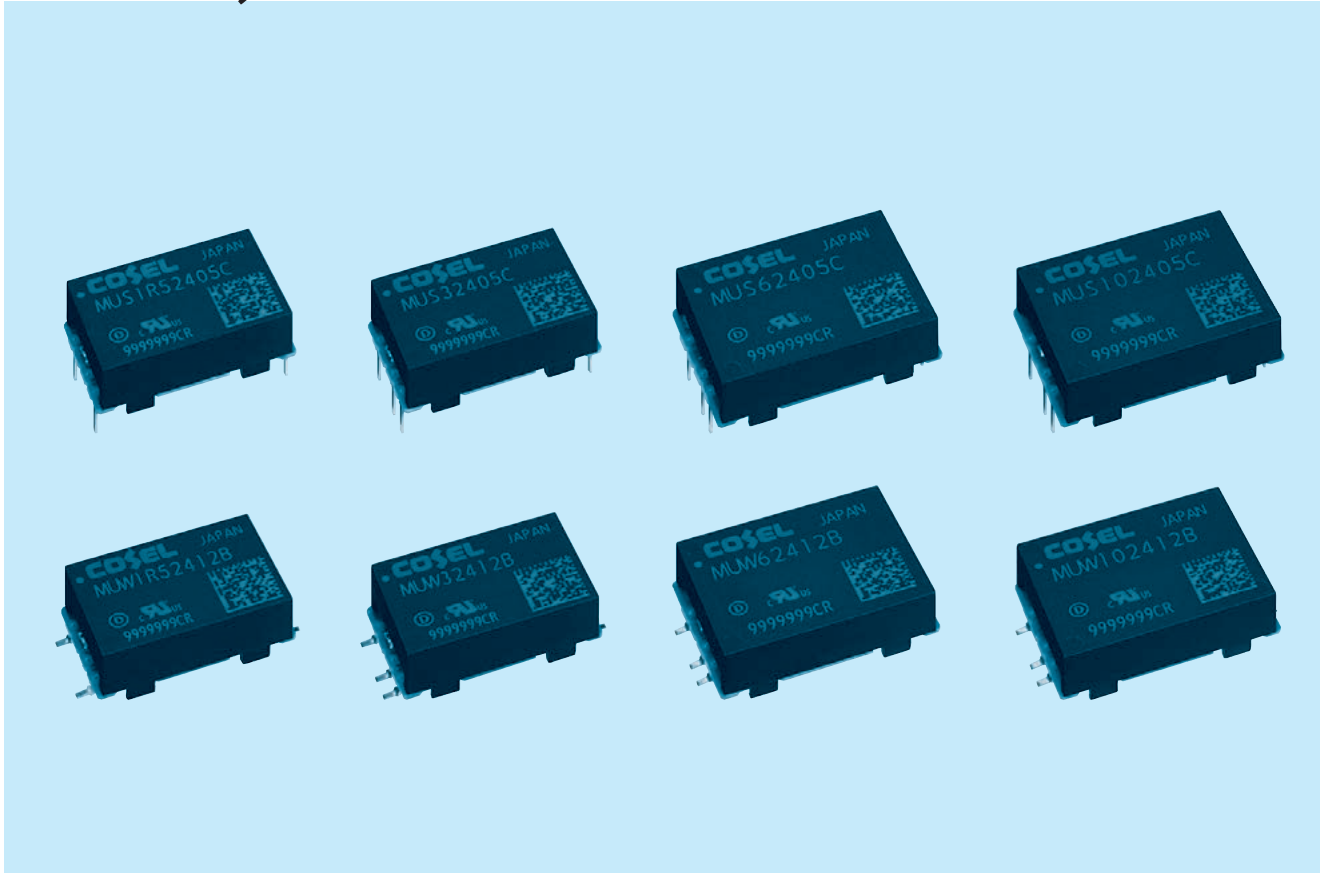

Feature

- SMD mounting type and through-hole mounting type
- High efficiency
- Built-in overcurrent protection circuits
- Built-in remote ON/OFF (MU3, 6, 10)
- High reliability : not built-in aluminum and tantalum electrolytic capacitor

CE marking

- Low Voltage Directive
- RoHS Directive

UKCA marking

- Electrical Equipment Safety Regulations
- RoHS Regulations

Safety agency approvals

- UL62368-1,
- C-UL (equivalent to CAN CSA-C22.2 No.62368-1), EN62368-1

5-year warranty

MUS1R5

MU S 1R5 12 05 B - □

① ② ③ ④ ⑤ ⑥ ⑦

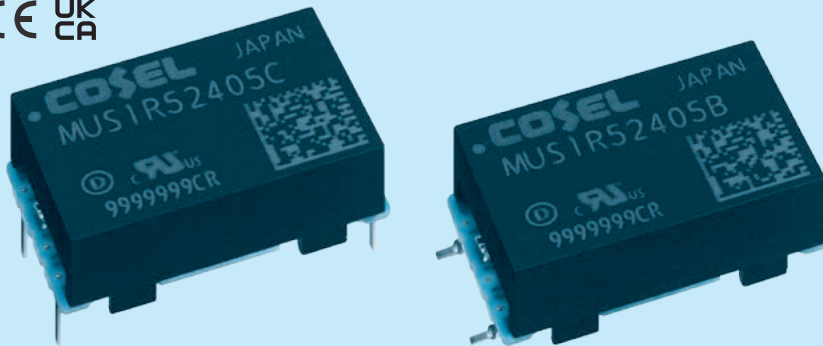

- ① Series name
- ② Single output
- ③ Output wattage
- ④ Input voltage
- ⑤ Output voltage
- ⑥ Mounting type
B :SMD
C :DIP
- ⑦ Optional
G :Capacitor between Input and Output is removed.

MODEL	MUS1R5053R3	MUS1R50505	MUS1R50512	MUS1R50515	MUS1R5123R3	MUS1R51205	MUS1R51212	MUS1R51215
MAX OUTPUT WATTAGE[W]	1.32	1.50	1.56	1.50	1.32	1.50	1.56	1.50
DC OUTPUT	VOLTAGE[V]	3.3	5	12	15	3.3	5	12
	CURRENT[A]	0.4	0.3	0.13	0.1	0.4	0.3	0.13

SPECIFICATIONS

	MODEL	MUS1R5053R3	MUS1R50505	MUS1R50512	MUS1R50515	MUS1R5123R3	MUS1R51205	MUS1R51212	MUS1R51215	
INPUT	VOLTAGE[VDC]	4.5 - 9 (Surge voltage 12.5V, 100ms max)				9 - 18 (Surge voltage 25V, 100ms max)				
	CURRENT[A]	*1 0.34typ	0.36typ	0.37typ	0.36typ	0.14typ	0.15typ	0.16typ	0.15typ	
	EFFICIENCY[%]	*1 79typ	83typ	84typ	84typ	79typ	84typ	84typ	84typ	
OUTPUT	VOLTAGE[V]	3.3	5	12	15	3.3	5	12	15	
	CURRENT[A]	0.4	0.3	0.13	0.1	0.4	0.3	0.13	0.1	
	LINE REGULATION[mV]	20max	20max	48max	60max	20max	20max	48max	60max	
	LOAD REGULATION[mV]	20max	20max	48max	60max	20max	20max	48max	60max	
	RIPPLE[mVp-p]	*2 120max	120max	150max	150max	120max	120max	150max	150max	
	RIPPLE NOISE[mVp-p]	*2 200max	200max	200max	200max	200max	200max	200max	200max	
	TEMPERATURE REGULATION[mV]	-20 to +85°C	50max	50max	150max	180max	50max	50max	150max	180max
		-40 to +85°C	80max	80max	240max	290max	80max	80max	240max	290max
	START-UP TIME[ms]	20max (Minimum input, I _o =100%)								
	OUTPUT VOLTAGE ADJUSTMENT RANGE	Fixed (TRM pin open) +10%, -5% adjustable by external VR								
OUTPUT VOLTAGE SETTING[V]	3.21 - 3.42	4.90 - 5.21	11.64 - 12.36	14.55 - 15.45	3.21 - 3.42	4.90 - 5.21	11.64 - 12.36	14.55 - 15.45		
PROTECTION CIRCUIT	OVERCURRENT PROTECTION	Works over 105% of rating and recovers automatically								

MODEL	MUS1R5243R3	MUS1R52405	MUS1R52412	MUS1R52415	MUS1R5483R3	MUS1R54805	MUS1R54812	MUS1R54815
MAX OUTPUT WATTAGE[W]	1.32	1.50	1.56	1.50	1.32	1.50	1.56	1.50
DC OUTPUT	VOLTAGE[V]	3.3	5	12	15	3.3	5	12
	CURRENT[A]	0.4	0.3	0.13	0.1	0.4	0.3	0.13

SPECIFICATIONS

	MODEL	MUS1R5243R3	MUS1R52405	MUS1R52412	MUS1R52415	MUS1R5483R3	MUS1R54805	MUS1R54812	MUS1R54815	
INPUT	VOLTAGE[VDC]	18 - 36 (Surge voltage 50V, 100ms max)				36 - 76 (Surge voltage 100V, 100ms max)				
	CURRENT[A]	*1 0.073typ	0.079typ	0.082typ	0.079typ	0.037typ	0.040typ	0.042typ	0.040typ	
	EFFICIENCY[%]	*1 76typ	80typ	80typ	80typ	75typ	79typ	79typ	79typ	
OUTPUT	VOLTAGE[V]	3.3	5	12	15	3.3	5	12	15	
	CURRENT[A]	0.4	0.3	0.13	0.1	0.4	0.3	0.13	0.1	
	LINE REGULATION[mV]	20max	20max	48max	60max	20max	20max	48max	60max	
	LOAD REGULATION[mV]	20max	20max	48max	60max	20max	20max	48max	60max	
	RIPPLE[mVp-p]	*2 120max	120max	150max	150max	120max	120max	150max	150max	
	RIPPLE NOISE[mVp-p]	*2 200max	200max	200max	200max	200max	200max	200max	200max	
	TEMPERATURE REGULATION[mV]	-20 to +85°C	50max	50max	150max	180max	50max	50max	150max	180max
		-40 to +85°C	80max	80max	240max	290max	80max	80max	240max	290max
	START-UP TIME[ms]	20max (Minimum input, I _o =100%)								
	OUTPUT VOLTAGE ADJUSTMENT RANGE	Fixed (TRM pin open) +10%, -5% adjustable by external VR								
OUTPUT VOLTAGE SETTING[V]	3.21 - 3.42	4.90 - 5.21	11.64 - 12.36	14.55 - 15.45	3.21 - 3.42	4.90 - 5.21	11.64 - 12.36	14.55 - 15.45		
PROTECTION CIRCUIT	OVERCURRENT PROTECTION	Works over 105% of rating and recovers automatically								

GENERAL SPECIFICATIONS

ISOLATION	INPUT-OUTPUT	AC500V 1minute, Cutoff current=10mA, DC500V 50MΩ min (20±15°C)
ENVIRONMENT	OPERATING TEMP., HUMID. AND ALTITUDE	-40 to +100°C, 20 to 95%RH (Non condensing) (Refer to "Derating"), 5,000m (16,400feet) max
	STORAGE TEMP., HUMID. AND ALTITUDE	-40 to +100°C, 20 to 95%RH (Non condensing), 9,000m (30,000feet) max
	VIBRATION	10 - 55Hz 98.0m/s ² (10G), 3minute period, 60minutes each along X, Y and Z axis
	IMPACT	490.3m/s ² (50G) 11ms, once each along X, Y and Z axis
SAFETY	AGENCY APPROVALS	UL62368-1 C-UL (equivalent to CAN / CSA-C22.2 No.62368-1), EN62368-1
OTHERS	CASE SIZE/WEIGHT	21.4 X 8.5 X 13.4mm [0.84 X 0.33 X 0.53 inches] (W X H X D) / 3g max
	COOLING METHOD	Convection/Forced air

- *1 Rated input 5V, 12V, 24V or 48V DC I_o=100%
- *2 Ripple and ripple noise is measured by using test board with ceramic capacitor 1μF at 25mm from output pins.
- * Parallel operation with other model is not possible.
- * MUW1R5xx12/MUW1R5xx15 is available as single output, +24V/+30V

Block diagram

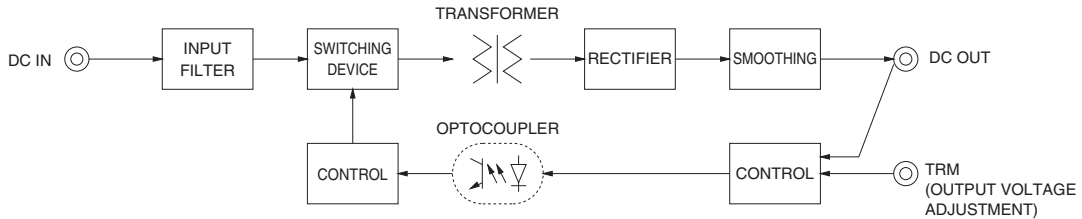

External view

1. SMD(type B)

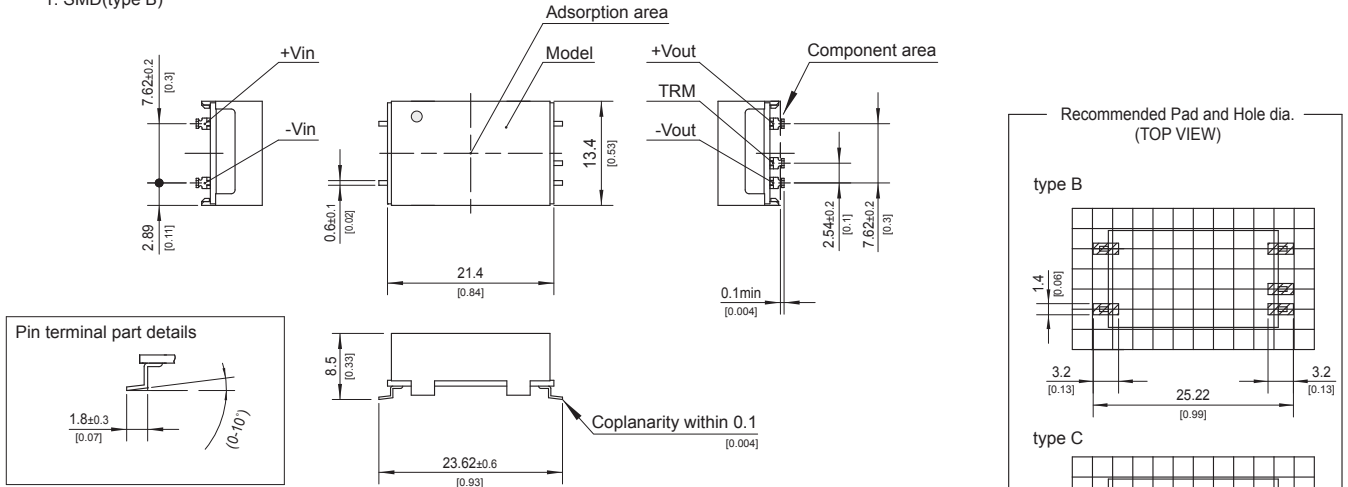

2. DIP(type C)

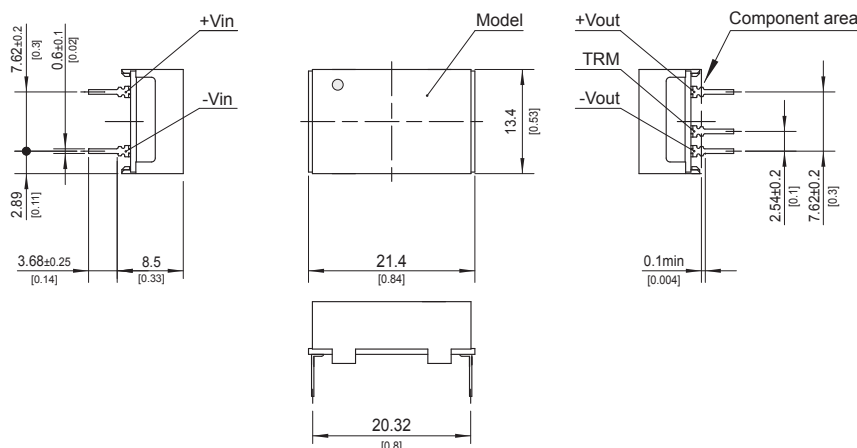

- ※ Tolerance ±0.5 [±0.02]
- ※ Dimensions in mm, []=inches
- ※ Pin terminal thickness : 0.3±0.1 [0.012]
- ※ Pin terminal material : Copper alloy
- ※ Plating treatment of terminal : Lead free plating
- ※ Case material : PPS
- ※ Weight : 3g max

MUW1R5

MU W 1R5 12 12 B - □

① ② ③ ④ ⑤ ⑥ ⑦

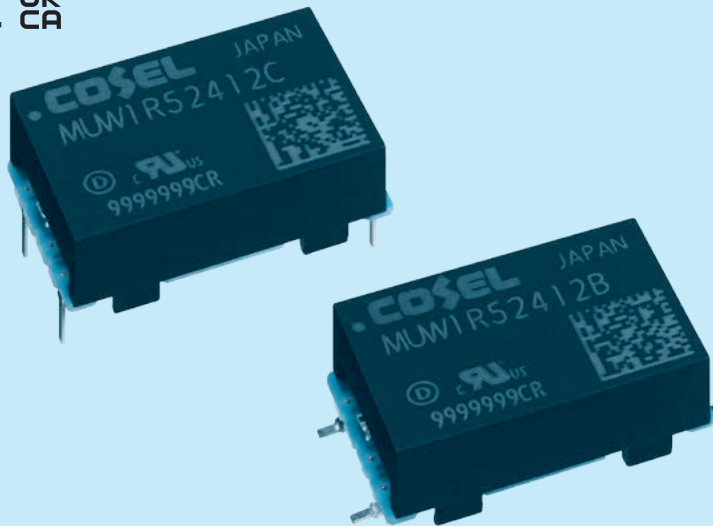

- ① Series name
- ② Dual output
- ③ Output wattage
- ④ Input voltage
- ⑤ Output voltage
- ⑥ Mounting type
B :SMD
C :DIP
- ⑦ Optional
G :Capacitor between Input and Output is removed.

MODEL	MUW1R50512	MUW1R50515	MUW1R51212	MUW1R51215	MUW1R52412	MUW1R52415	MUW1R54812	MUW1R54815
MAX OUTPUT WATTAGE[W]	1.56	1.50	1.56	1.50	1.56	1.50	1.56	1.50
DC OUTPUT	VOLTAGE[V] *1	±12 or +24	±15 or +30	±12 or +24	±15 or +30	±12 or +24	±15 or +30	±12 or +24
	CURRENT[A]	0.065	0.05	0.065	0.05	0.065	0.05	0.065

SPECIFICATIONS

	MODEL	MUW1R50512	MUW1R50515	MUW1R51212	MUW1R51215	MUW1R52412	MUW1R52415	MUW1R54812	MUW1R54815	
INPUT	VOLTAGE[VDC]	4.5 - 9 (Surge voltage 12.5V, 100ms max)		9 - 18 (Surge voltage 25V, 100ms max)		18 - 36 (Surge voltage 50V, 100ms max)		36 - 76 (Surge voltage 100V, 100ms max)		
	CURRENT[A] *2	0.39typ	0.37typ	0.16typ	0.16typ	0.083typ	0.080typ	0.042typ	0.041typ	
	EFFICIENCY[%] *2	82typ	82typ	82typ	82typ	79typ	79typ	78typ	78typ	
OUTPUT	VOLTAGE[V]	±12 or +24	±15 or +30	±12 or +24	±15 or +30	±12 or +24	±15 or +30	±12 or +24	±15 or +30	
	CURRENT[A]	0.065	0.05	0.065	0.05	0.065	0.05	0.065	0.05	
	LINE REGULATION[mV]	60max	75max	60max	75max	60max	75max	60max	75max	
	LOAD REGULATION[mV]	*3	480max	600max	480max	600max	480max	600max	480max	600max
		*4	600max	750max	600max	750max	600max	750max	600max	750max
	RIPPLE[mVp-p] *5	150max	150max	150max	150max	150max	150max	150max	150max	
	RIPPLE NOISE[mVp-p] *5	200max	200max	200max	200max	200max	200max	200max	200max	
	TEMPERATURE REGULATION[mV]	-20 to +85°C	210max	260max	210max	260max	210max	260max	210max	260max
		-40 to +85°C	320max	390max	320max	390max	320max	390max	320max	390max
	START-UP TIME[ms]	20max (Minimum input, I _o =100%)								
OUTPUT VOLTAGE ADJUSTMENT RANGE	Fixed (TRM pin open) +10%, -5% adjustable by external VR									
OUTPUT VOLTAGE SETTING[V]	11.64 - 12.36	14.55 - 15.45	11.64 - 12.36	14.55 - 15.45	11.64 - 12.36	14.55 - 15.45	11.64 - 12.36	14.55 - 15.45		
PROTECTION CIRCUIT	OVERCURRENT PROTECTION	Works over 105% of rating and recovers automatically								
ISOLATION	INPUT-OUTPUT	AC500V 1minute, Cutoff current=10mA, DC500V 50MΩ min (20±15C)								
ENVIRONMENT	OPERATING TEMP., HUMID. AND ALTITUDE	-40 to +100°C, 20 to 95%RH (Non condensing) (Refer to "Derating"), 5,000m (16,400feet) max								
	STORAGE TEMP., HUMID. AND ALTITUDE	-40 to +100°C, 20 to 95%RH (Non condensing), 9,000m (30,000feet) max								
	VIBRATION	10 - 55Hz 98.0m/s ² (10G), 3minute period, 60minutes each along X, Y and Z axis								
	IMPACT	490.3m/s ² (50G) 11ms, once each along X, Y and Z axis								
SAFETY	AGENCY APPROVALS	UL62368-1 C-UL (equivalent to CAN / CSA-C22.2 No.62368-1), EN62368-1								
OTHERS	CASE SIZE/WEIGHT	21.4 × 8.5 × 13.4 [0.84 × 0.33 × 0.53 inches] (W × H × D) / 3g max								
	COOLING METHOD	Convection/Forced air								

*1 Single output +24V, +30V with no use of COM.
 *2 Rated input 5V, 12V, 24V or 48V DC I_o=100%
 *3 Symmetrical loading from 20% to 100%.
 *4 Symmetrical loading from 0% to 100%.
 *5 Ripple and Ripple Noise is measured by using test board with ceramic capacitor 1μF at 25mm from output pins.
 * Parallel operation with other model is not possible.

Block diagram

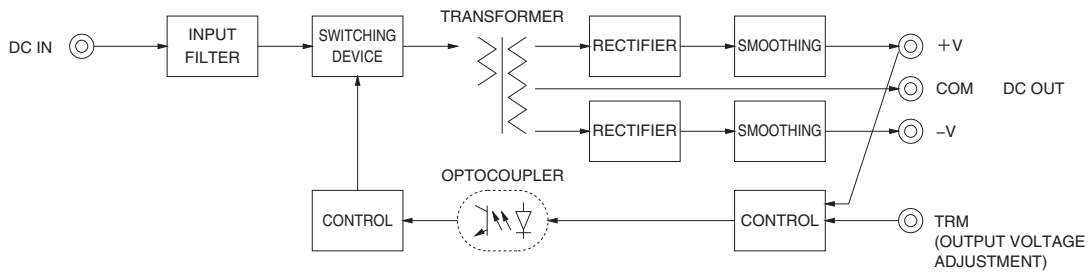

External view

1. SMD(type B)

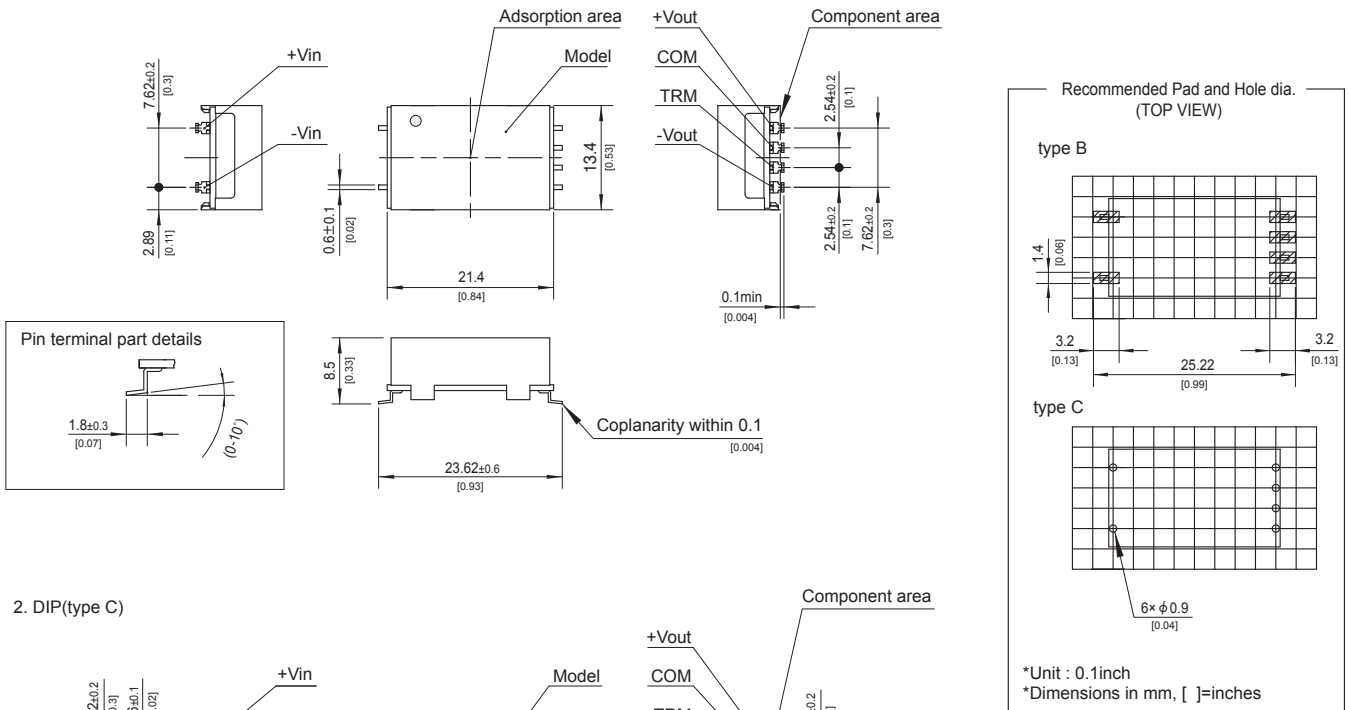

2. DIP(type C)

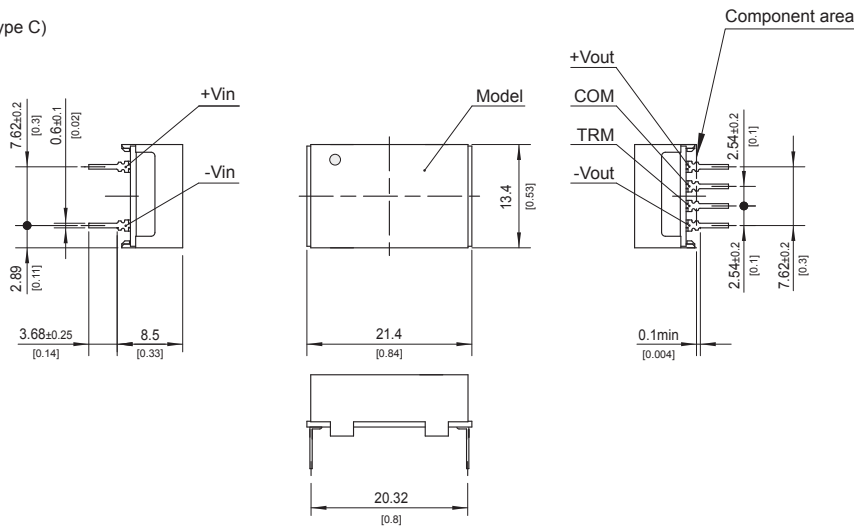

- ※ Tolerance ± 0.5 [± 0.02]
- ※ Dimensions in mm, []= inches
- ※ Pin terminal thickness : 0.3 ± 0.1 [0.012]
- ※ Pin terminal material : Copper alloy
- ※ Plating treatment of terminal : Lead free plating
- ※ Case material : PPS
- ※ Weight : 3g max

MUS3

MU S 3 12 05 B - □

① ② ③ ④ ⑤ ⑥ ⑦

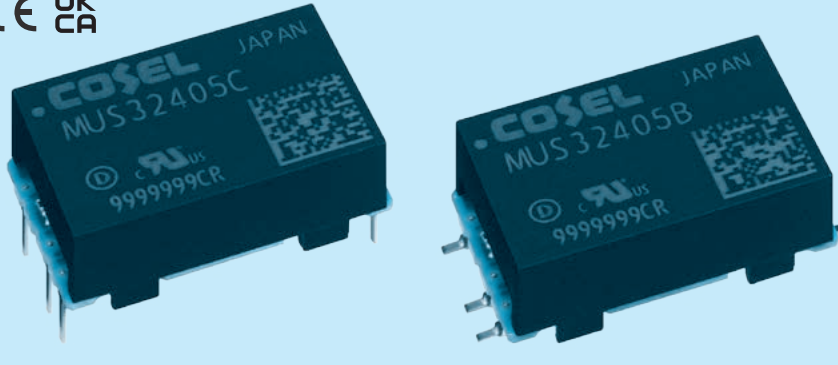

- ① Series name
- ② Single output
- ③ Output wattage
- ④ Input voltage
- ⑤ Output voltage
- ⑥ Mounting type
B :SMD
C :DIP
- ⑦ Optional
G :Capacitor between Input and Output is removed.

MODEL	MUS3053R3	MUS30505	MUS30512	MUS30515	MUS3123R3	MUS31205	MUS31212	MUS31215	
MAX OUTPUT WATTAGE[W]	1.98	3	3	3	1.98	3	3	3	
DC OUTPUT	VOLTAGE[V]	3.3	5	12	15	3.3	5	12	15
	CURRENT[A]	0.6	0.6	0.25	0.2	0.6	0.6	0.25	0.2

SPECIFICATIONS

	MODEL	MUS3053R3	MUS30505	MUS30512	MUS30515	MUS3123R3	MUS31205	MUS31212	MUS31215	
INPUT	VOLTAGE[VDC]	4.5 - 9 (Surge voltage 12.5V, 100ms max)				9 - 18 (Surge voltage 25V, 100ms max)				
	CURRENT[A]	*1 0.5typ	0.72typ	0.71typ	0.71typ	0.21typ	0.3typ	0.29typ	0.29typ	
	EFFICIENCY[%]	*1 79typ	83typ	85typ	85typ	80typ	84typ	86typ	86typ	
OUTPUT	VOLTAGE[V]	3.3	5	12	15	3.3	5	12	15	
	CURRENT[A]	0.6	0.6	0.25	0.2	0.6	0.6	0.25	0.2	
	LINE REGULATION[mV]	20max	20max	48max	60max	20max	20max	48max	60max	
	LOAD REGULATION[mV]	20max	20max	48max	60max	20max	20max	48max	60max	
	RIPPLE[mVp-p]	*2 120max	120max	150max	150max	120max	120max	150max	150max	
	RIPPLE NOISE[mVp-p]	*2 200max	200max	200max	200max	200max	200max	200max	200max	
	TEMPERATURE REGULATION[mV]	-20 to +85°C	50max	50max	150max	180max	50max	50max	150max	180max
		-40 to +85°C	80max	80max	240max	290max	80max	80max	240max	290max
	START-UP TIME[ms]	20max (Minimum input, Io=100%)								
	OUTPUT VOLTAGE ADJUSTMENT RANGE	Fixed (TRM pin open) +10%, -5% adjustable by external VR								
OUTPUT VOLTAGE SETTING[V]	3.21 - 3.42	4.90 - 5.21	11.64 - 12.36	14.55 - 15.45	3.21 - 3.42	4.90 - 5.21	11.64 - 12.36	14.55 - 15.45		
PROTECTION CIRCUIT AND OTHERS	OVERCURRENT PROTECTION	Works over 105% of rating and recovers automatically								
	REMOTE ON/OFF	Provided (Negative logic L : ON, H :OFF)								

MODEL	MUS3243R3	MUS32405	MUS32412	MUS32415	MUS3483R3	MUS34805	MUS34812	MUS34815	
MAX OUTPUT WATTAGE[W]	1.98	3	3	3	1.998	3	3	3	
DC OUTPUT	VOLTAGE[V]	3.3	5	12	15	3.3	5	12	15
	CURRENT[A]	0.6	0.6	0.25	0.2	0.6	0.6	0.25	0.2

SPECIFICATIONS

	MODEL	MUS3243R3	MUS32405	MUS32412	MUS32415	MUS3483R3	MUS34805	MUS34812	MUS34815	
INPUT	VOLTAGE[VDC]	18 - 36 (Surge voltage 50V, 100ms max)				36 - 76 (Surge voltage 100V, 100ms max)				
	CURRENT[A]	*1 0.11typ	0.15typ	0.15typ	0.15typ	0.053typ	0.076typ	0.074typ	0.074typ	
	EFFICIENCY[%]	*1 78typ	83typ	85typ	85typ	78typ	83typ	85typ	85typ	
OUTPUT	VOLTAGE[V]	3.3	5	12	15	3.3	5	12	15	
	CURRENT[A]	0.6	0.6	0.25	0.2	0.6	0.6	0.25	0.2	
	LINE REGULATION[mV]	20max	20max	48max	60max	20max	20max	48max	60max	
	LOAD REGULATION[mV]	20max	20max	48max	60max	20max	20max	48max	60max	
	RIPPLE[mVp-p]	*2 120max	120max	150max	150max	120max	120max	150max	150max	
	RIPPLE NOISE[mVp-p]	*2 200max	200max	200max	200max	200max	200max	200max	200max	
	TEMPERATURE REGULATION[mV]	-20 to +85°C	50max	50max	150max	180max	50max	50max	150max	180max
		-40 to +85°C	80max	80max	240max	290max	80max	80max	240max	290max
	START-UP TIME[ms]	20max (Minimum input, Io=100%)								
	OUTPUT VOLTAGE ADJUSTMENT RANGE	Fixed (TRM pin open) +10%, -5% adjustable by external VR								
OUTPUT VOLTAGE SETTING[V]	3.21 - 3.42	4.90 - 5.21	11.64 - 12.36	14.55 - 15.45	3.21 - 3.42	4.90 - 5.21	11.64 - 12.36	14.55 - 15.45		
PROTECTION CIRCUIT AND OTHERS	OVERCURRENT PROTECTION	Works over 105% of rating and recovers automatically								
	REMOTE ON/OFF	Provided (Negative logic L : ON, H :OFF)								

GENERAL SPECIFICATIONS

ISOLATION	INPUT-OUTPUT	AC500V 1minute, Cutoff current=10mA, DC500V 50MΩ min (20±15°C)
ENVIRONMENT	OPERATING TEMP., HUMID. AND ALTITUDE	-40 to +100°C, 20 to 95%RH (Non condensing) (Refer to "Derating"), 5,000m (16,400feet) max
	STORAGE TEMP., HUMID. AND ALTITUDE	-40 to +100°C, 20 to 95%RH (Non condensing), 9,000m (30,000feet) max
	VIBRATION	10 - 55Hz 98.0m/s ² (10G), 3minute period, 60minutes each along X, Y and Z axis
	IMPACT	490.3m/s ² (50G) 11ms, once each along X, Y and Z axis
SAFETY	AGENCY APPROVALS	UL62368-1 C-UL (equivalent to CAN / CSA-C22.2 No.62368-1), EN62368-1
OTHERS	CASE SIZE/WEIGHT	21.4 X 8.5 X 13.4mm [0.84 X 0.33 X 0.53 inches] (W X H X D) / 3g max
	COOLING METHOD	Convection/Forced air

- *1 Rated input 5V, 12V, 24V or 48V DC I_o=100%
- *2 Ripple and ripple noise is measured by using test board with ceramic capacitor 1μF at 25mm from output pins.
- * Parallel operation with other model is not possible.
- * MUW3xx12/MUW3xx15 is available as single output, +24V/+30V

Block diagram

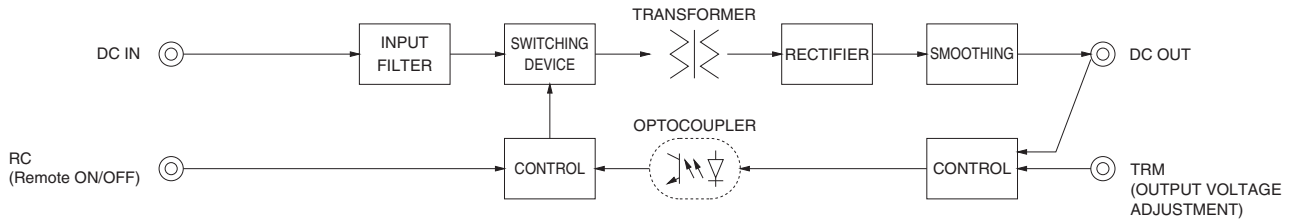

External view

1. SMD(type B)

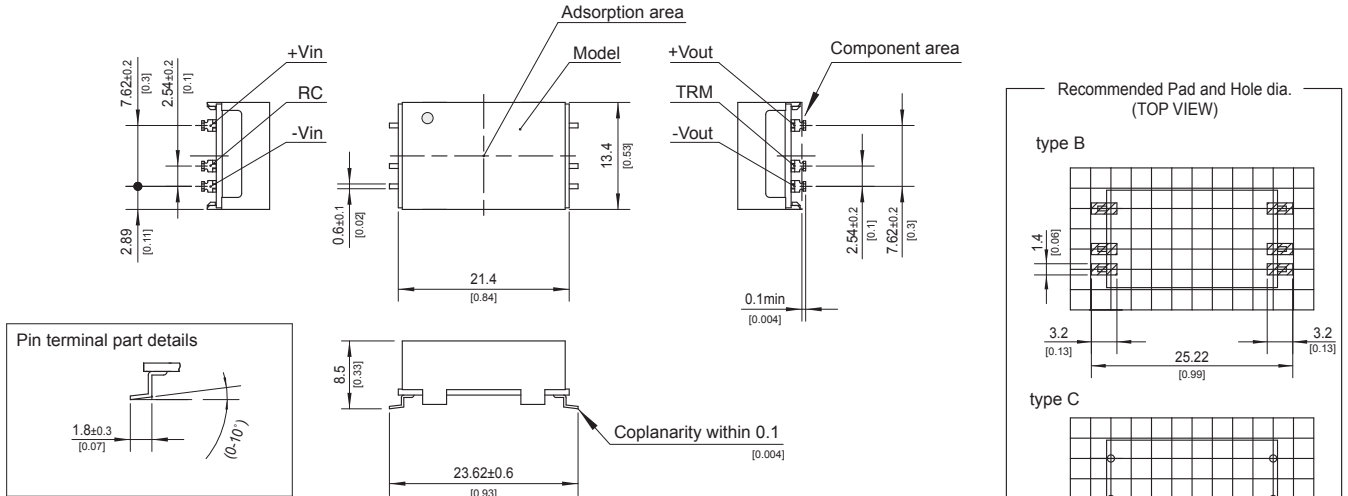

2. DIP(type C)

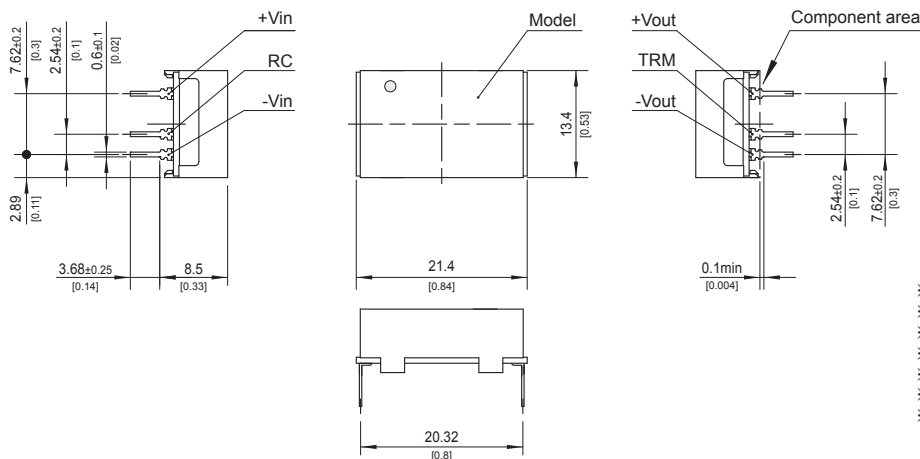

- ※ Tolerance ±0.5 [±0.02]
- ※ Dimensions in mm, [] = inches
- ※ Pin terminal thickness : 0.3±0.1 [0.012]
- ※ Pin terminal material : Copper alloy
- ※ Plating treatment of terminal : Lead free plating
- ※ Case material : PPS
- ※ Weight : 3g max

MUW3

MU W 3 12 12 B - □

① ② ③ ④ ⑤ ⑥ ⑦

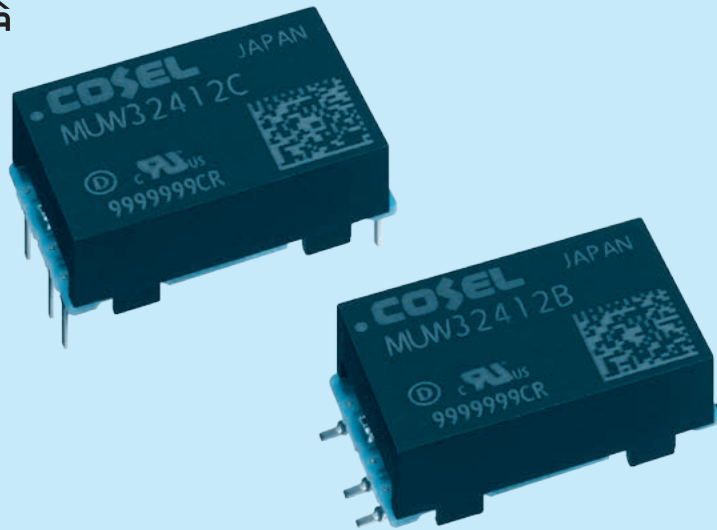

- ① Series name
- ② Dual output
- ③ Output wattage
- ④ Input voltage
- ⑤ Output voltage
- ⑥ Mounting type
B : SMD
C : DIP
- ⑦ Optional
G : Capacitor between Input and Output is removed.

MODEL	MUW30512	MUW30515	MUW31212	MUW31215	MUW32412	MUW32415	MUW34812	MUW34815	
MAX OUTPUT WATTAGE[W]	3.12	3	3.12	3	3.12	3	3.12	3	
DC OUTPUT	VOLTAGE[V] *1	±12 or +24	±15 or +30	±12 or +24	±15 or +30	±12 or +24	±15 or +30	±12 or +24	±15 or +30
	CURRENT[A]	0.13	0.1	0.13	0.1	0.13	0.1	0.13	0.1

SPECIFICATIONS

	MODEL	MUW30512	MUW30515	MUW31212	MUW31215	MUW32412	MUW32415	MUW34812	MUW34815	
INPUT	VOLTAGE[VDC]	4.5 - 9 (Surge voltage 12.5V, 100ms max)		9 - 18 (Surge voltage 25V, 100ms max)		18 - 36 (Surge voltage 50V, 100ms max)		36 - 76 (Surge voltage 100V, 100ms max)		
	CURRENT[A] *2	0.75typ	0.72typ	0.31typ	0.3typ	0.16typ	0.15typ	0.078typ	0.075typ	
	EFFICIENCY[%] *2	84typ	84typ	84typ	84typ	84typ	84typ	84typ	84typ	
OUTPUT	VOLTAGE[V]	±12 or +24	±15 or +30	±12 or +24	±15 or +30	±12 or +24	±15 or +30	±12 or +24	±15 or +30	
	CURRENT[A]	0.13	0.1	0.13	0.1	0.13	0.1	0.13	0.1	
	LINE REGULATION[mV]	60max	75max	60max	75max	60max	75max	60max	75max	
	LOAD REGULATION[mV]	*3	480max	600max	480max	600max	480max	600max	480max	600max
		*4	600max	750max	600max	750max	600max	750max	600max	750max
	RIPPLE[mVp-p] *5	150max	150max	150max	150max	150max	150max	150max	150max	
	RIPPLE NOISE[mVp-p] *5	200max	200max	200max	200max	200max	200max	200max	200max	
	TEMPERATURE REGULATION[mV]	-20 to +85°C	210max	260max	210max	260max	210max	260max	210max	260max
		-40 to +85°C	320max	390max	320max	390max	320max	390max	320max	390max
	START-UP TIME[ms]	20max (Minimum input, I _o =100%)								
OUTPUT VOLTAGE ADJUSTMENT RANGE	Fixed (TRM pin open) +10%, -5% adjustable by external VR									
OUTPUT VOLTAGE SETTING[V]	11.64 - 12.36	14.55 - 15.45	11.64 - 12.36	14.55 - 15.45	11.64 - 12.36	14.55 - 15.45	11.64 - 12.36	14.55 - 15.45		
PROTECTION CIRCUIT AND OTHERS	OVERCURRENT PROTECTION	Works over 105% of rating and recovers automatically								
	REMOTE ON/OFF	Provided (Negative logic L : ON, H : OFF)								
ISOLATION	INPUT-OUTPUT	AC500V 1minute, Cutoff current=10mA, DC500V 50MΩ min (20±15C)								
ENVIRONMENT	OPERATING TEMP., HUMID. AND ALTITUDE	-40 to +100°C, 20 to 95%RH (Non condensing) (Refer to "Derating"), 5,000m (16,400feet) max								
	STORAGE TEMP., HUMID. AND ALTITUDE	-40 to +100°C, 20 to 95%RH (Non condensing), 9,000m (30,000feet) max								
	VIBRATION	10 - 55Hz 98.0m/s ² (10G), 3minute period, 60minutes each along X, Y and Z axis								
	IMPACT	490.3m/s ² (50G) 11ms, once each along X, Y and Z axis								
SAFETY	AGENCY APPROVALS	UL62368-1 C-UL (equivalent to CAN / CSA-C22.2 No.62368-1), EN62368-1								
OTHERS	CASE SIZE/WEIGHT	21.4 × 8.5 × 13.4mm [0.84 × 0.33 × 0.53 inches] (W × H × D) / 3g max								
	COOLING METHOD	Convection/Forced air								

*1 Single output +24V, +30V with no use of COM.
 *2 Rated input 5V, 12V, 24V or 48V DC I_o=100%
 *3 Symmetrical loading from 20% to 100%.
 *4 Symmetrical loading from 0% to 100%.
 *5 Ripple and Ripple Noise is measured by using test board with ceramic capacitor 1μF at 25mm from output pins.
 * Parallel operation with other model is not possible.

Block diagram

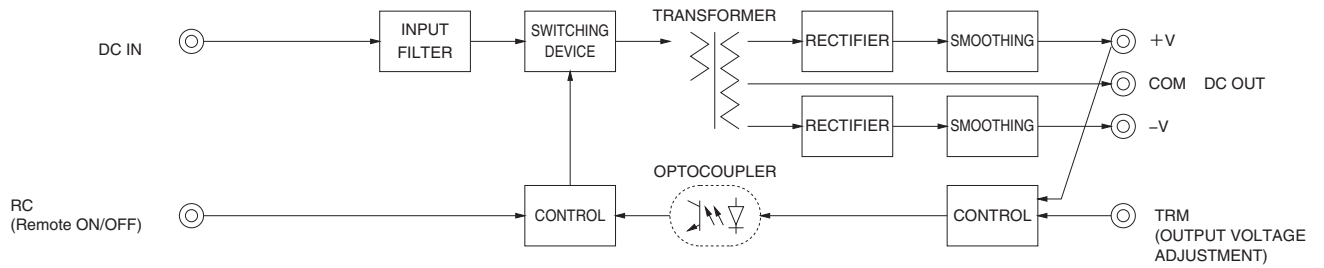

External view

1. SMD(type B)

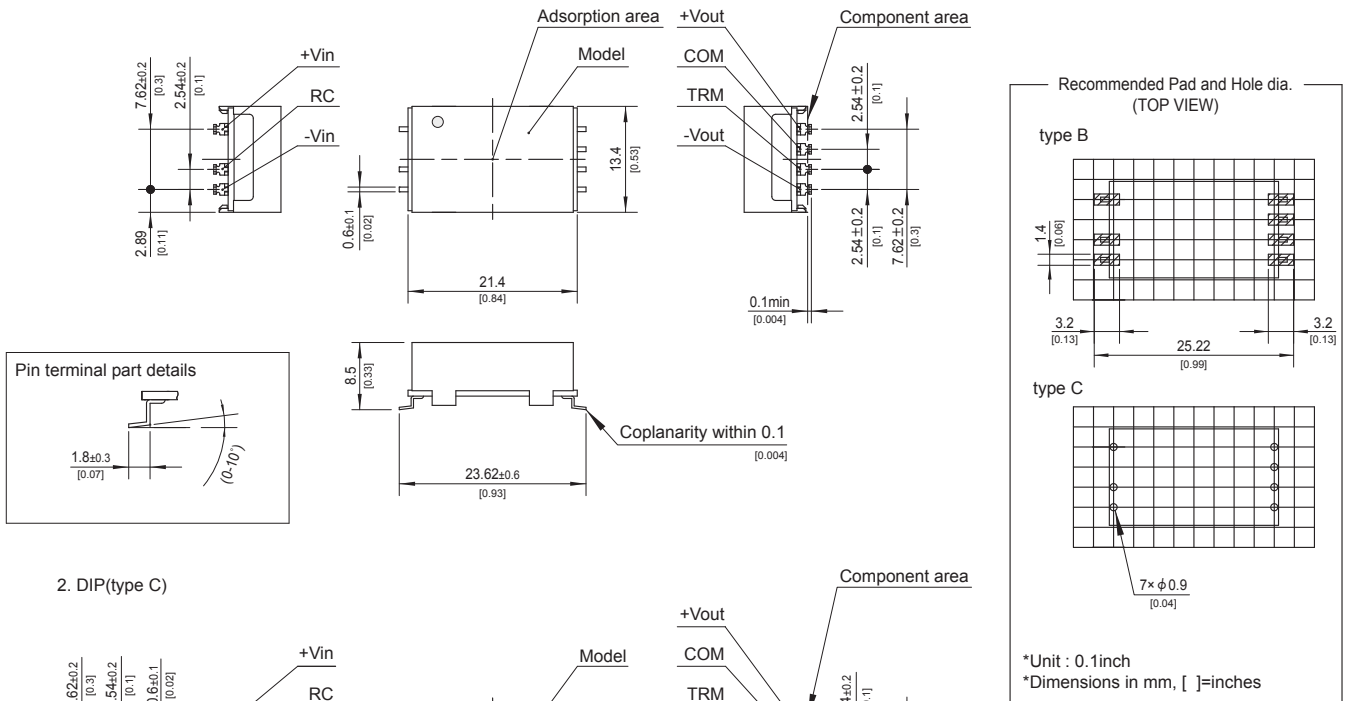

2. DIP(type C)

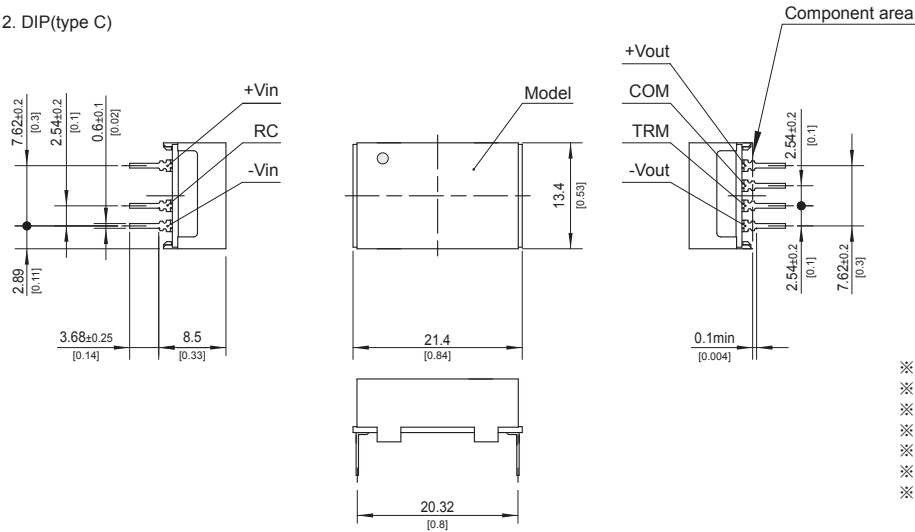

- ※ Tolerance ± 0.5 [± 0.02]
- ※ Dimensions in mm, []= inches
- ※ Pin terminal thickness : 0.3 ± 0.1 [0.012]
- ※ Pin terminal material : Copper alloy
- ※ Plating treatment of terminal : Lead free plating
- ※ Case material : PPS
- ※ Weight : 3g max

MUS6

MU S 6 12 05 B - □

① ② ③ ④ ⑤ ⑥ ⑦

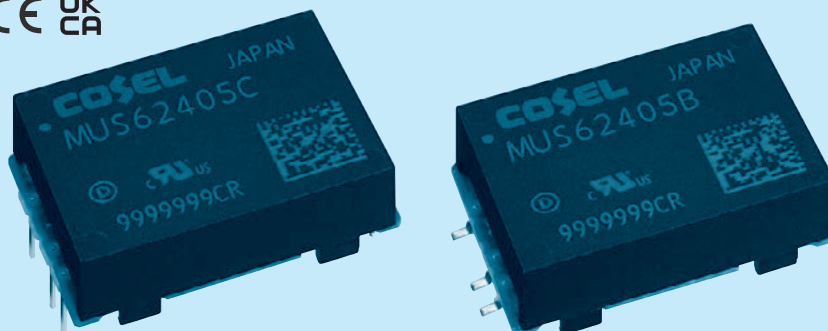

- ① Series name
- ② Single output
- ③ Output wattage
- ④ Input voltage
- ⑤ Output voltage
- ⑥ Mounting type
B :SMD
C :DIP
- ⑦ Optional
G :Capacitor between Input and Output is removed.

MODEL	MUS6053R3	MUS60505	MUS60512	MUS60515	MUS6123R3	MUS61205	MUS61212	MUS61215
MAX OUTPUT WATTAGE[W]	4.46	6.0	6.0	6.0	4.46	6.0	6.0	6.0
DC OUTPUT	VOLTAGE[V]	3.3	5	12	15	3.3	5	12
	CURRENT[A]	1.35	1.2	0.5	0.4	1.35	1.2	0.5

SPECIFICATIONS

	MODEL	MUS6053R3	MUS60505	MUS60512	MUS60515	MUS6123R3	MUS61205	MUS61212	MUS61215	
INPUT	VOLTAGE[VDC]	4.5 - 9 (Surge voltage 12.5V, 100ms max)				9 - 18 (Surge voltage 25V, 100ms max)				
	CURRENT[A]	*1 1.10typ	1.43typ	1.40typ	1.40typ	0.45typ	0.58typ	0.57typ	0.57typ	
	EFFICIENCY[%]	*1 81typ	84typ	86typ	86typ	82typ	86typ	88typ	88typ	
OUTPUT	VOLTAGE[V]	3.3	5	12	15	3.3	5	12	15	
	CURRENT[A]	1.35	1.2	0.5	0.4	1.35	1.2	0.5	0.4	
	LINE REGULATION[mV]	20max	20max	48max	60max	20max	20max	48max	60max	
	LOAD REGULATION[mV]	20max	20max	48max	60max	20max	20max	48max	60max	
	RIPPLE[mVp-p]	*2 120max	120max	150max	150max	120max	120max	150max	150max	
	RIPPLE NOISE[mVp-p]	*2 200max	200max	200max	200max	200max	200max	200max	200max	
	TEMPERATURE REGULATION[mV]	-20 to +70°C	50max	50max	150max	180max	50max	50max	150max	180max
		-40 to +70°C	80max	80max	240max	290max	80max	80max	240max	290max
	START-UP TIME[ms]	20max (Minimum input, Io=100%)								
	OUTPUT VOLTAGE ADJUSTMENT RANGE	Fixed (TRM pin open) +10%, -5% adjustable by external VR								
OUTPUT VOLTAGE SETTING[V]	3.21 - 3.42	4.90 - 5.21	11.64 - 12.36	14.55 - 15.45	3.21 - 3.42	4.90 - 5.21	11.64 - 12.36	14.55 - 15.45		
PROTECTION CIRCUIT AND OTHERS	OVERCURRENT PROTECTION	Works over 105% of rating and recovers automatically								
	REMOTE ON/OFF	Provided (Negative logic L : ON, H :OFF)								

MODEL	MUS6243R3	MUS62405	MUS62412	MUS62415	MUS6483R3	MUS64805	MUS64812	MUS64815
MAX OUTPUT WATTAGE[W]	4.46	6.0	6.0	6.0	4.46	6.0	6.0	6.0
DC OUTPUT	VOLTAGE[V]	3.3	5	12	15	3.3	5	12
	CURRENT[A]	1.35	1.2	0.5	0.4	1.35	1.2	0.5

SPECIFICATIONS

	MODEL	MUS6243R3	MUS62405	MUS62412	MUS62415	MUS6483R3	MUS64805	MUS64812	MUS64815	
INPUT	VOLTAGE[VDC]	18 - 36 (Surge voltage 50V, 100ms max)				36 - 76 (Surge voltage 100V, 100ms max)				
	CURRENT[A]	*1 0.23typ	0.30typ	0.29typ	0.29typ	0.12typ	0.15typ	0.14typ	0.14typ	
	EFFICIENCY[%]	*1 81typ	86typ	88typ	88typ	82typ	86typ	88typ	88typ	
OUTPUT	VOLTAGE[V]	3.3	5	12	15	3.3	5	12	15	
	CURRENT[A]	1.35	1.2	0.5	0.4	1.35	1.2	0.5	0.4	
	LINE REGULATION[mV]	20max	20max	48max	60max	20max	20max	48max	60max	
	LOAD REGULATION[mV]	20max	20max	48max	60max	20max	20max	48max	60max	
	RIPPLE[mVp-p]	*2 120max	120max	150max	150max	120max	120max	150max	150max	
	RIPPLE NOISE[mVp-p]	*2 200max	200max	200max	200max	200max	200max	200max	200max	
	TEMPERATURE REGULATION[mV]	-20 to +70°C	50max	50max	150max	180max	50max	50max	150max	180max
		-40 to +70°C	80max	80max	240max	290max	80max	80max	240max	290max
	START-UP TIME[ms]	20max (Minimum input, Io=100%)								
	OUTPUT VOLTAGE ADJUSTMENT RANGE	Fixed (TRM pin open) +10%, -5% adjustable by external VR								
OUTPUT VOLTAGE SETTING[V]	3.21 - 3.42	4.90 - 5.21	11.64 - 12.36	14.55 - 15.45	3.21 - 3.42	4.90 - 5.21	11.64 - 12.36	14.55 - 15.45		
PROTECTION CIRCUIT AND OTHERS	OVERCURRENT PROTECTION	Works over 105% of rating and recovers automatically								
	REMOTE ON/OFF	Provided (Negative logic L : ON, H :OFF)								

GENERAL SPECIFICATIONS

ISOLATION	INPUT-OUTPUT	AC500V 1minute, Cutoff current=10mA, DC500V 50MΩ min (20±15°C)
ENVIRONMENT	OPERATING TEMP., HUMID. AND ALTITUDE	-40 to +95°C, 20 to 95%RH (Non condensing) (Refer to "Derating"), 5,000m (16,400feet) max
	STORAGE TEMP., HUMID. AND ALTITUDE	-40 to +100°C, 20 to 95%RH (Non condensing), 9,000m (30,000feet) max
	VIBRATION	10 - 55Hz 98.0m/s ² (10G), 3minute period, 60minutes each along X, Y and Z axis
	IMPACT	490.3m/s ² (50G) 11ms, once each along X, Y and Z axis
SAFETY	AGENCY APPROVALS	UL62368-1 C-UL (equivalent to CAN / CSA-C22.2 No.62368-1), EN62368-1
OTHERS	CASE SIZE/WEIGHT	24.0×8.5×17.3mm [0.94×0.33×0.68 inches] (W×H×D) / 5g max
	COOLING METHOD	Convection/Forced air

- *1 Rated input 5V, 12V, 24V or 48V DC I_o=100%
- *2 Ripple and ripple noise is measured by using test board with ceramic capacitor 1μF at 25mm from output pins.
- * Parallel operation with other model is not possible.
- * MUW6xx12/MUW6xx15 is available as single output, +24V/+30V

Block diagram

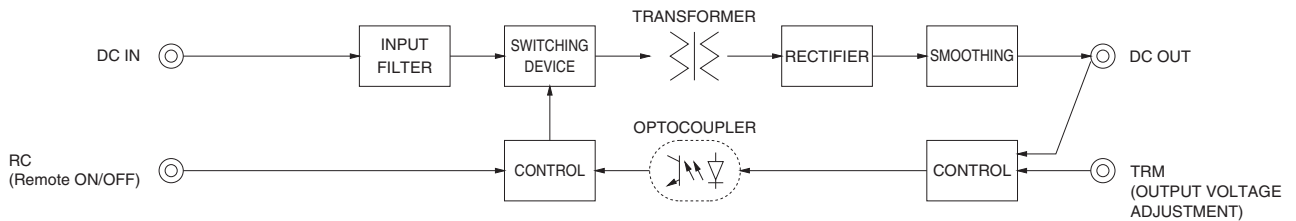

External view

1. SMD(type B)

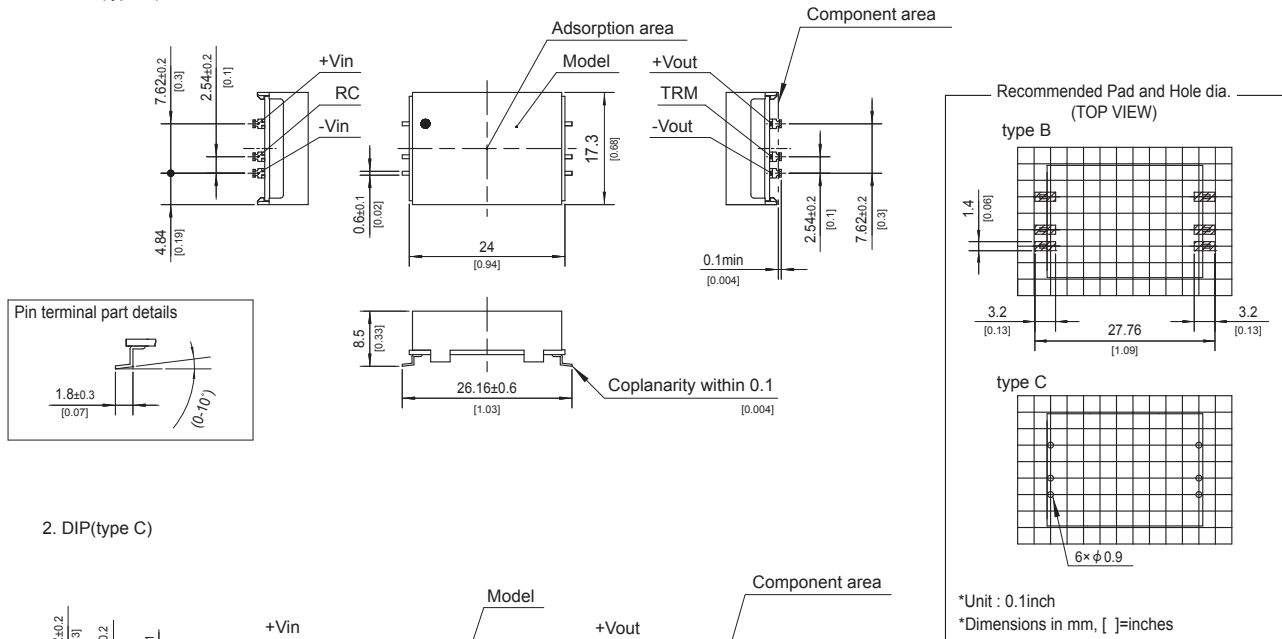

2. DIP(type C)

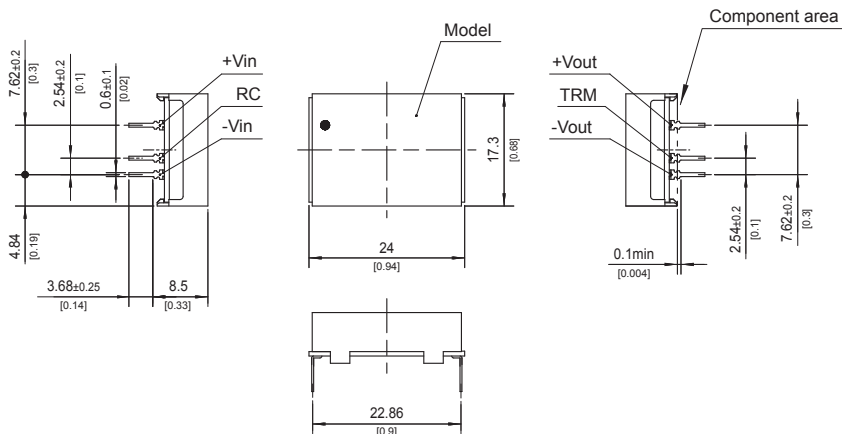

- ※ Tolerance -0.5 [-0.02]
- ※ Dimensions in mm, []= inches
- ※ Pin terminal thickness : 0.3-0.1 [0.012]
- ※ Pin terminal material : Copper alloy
- ※ Plating treatment of terminal : Lead free plating
- ※ Case material : PPS
- ※ Weight : 5g max

MUW6

MU W 6 12 12 B - □

① ② ③ ④ ⑤ ⑥ ⑦

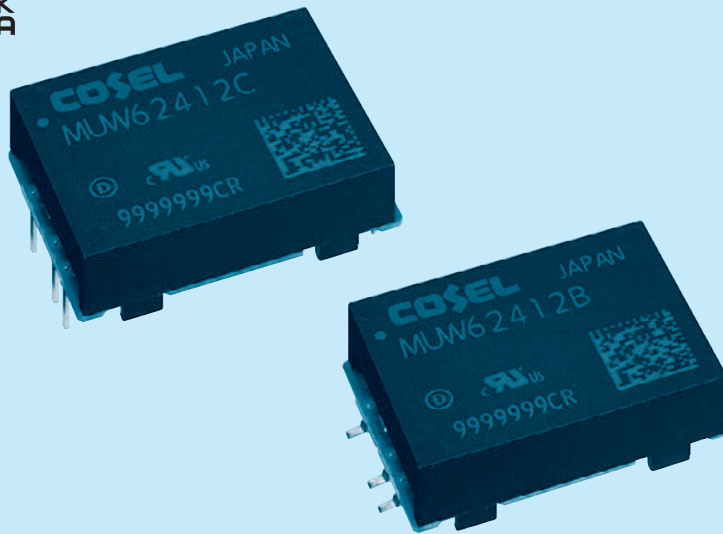

- ① Series name
- ② Dual output
- ③ Output wattage
- ④ Input voltage
- ⑤ Output voltage
- ⑥ Mounting type
B : SMD
C : DIP
- ⑦ Optional
G : Capacitor between Input and Output is removed.

MODEL	MUW60512	MUW60515	MUW61212	MUW61215	MUW62412	MUW62415	MUW64812	MUW64815	
MAX OUTPUT WATTAGE[W]	6	6	6	6	6	6	6	6	
DC OUTPUT	VOLTAGE[V] *1	±12 or +24	±15 or +30	±12 or +24	±15 or +30	±12 or +24	±15 or +30	±12 or +24	±15 or +30
	CURRENT[A]	0.25	0.2	0.25	0.2	0.25	0.2	0.25	0.2

SPECIFICATIONS

	MODEL	MUW60512	MUW60515	MUW61212	MUW61215	MUW62412	MUW62415	MUW64812	MUW64815	
INPUT	VOLTAGE[VDC]	4.5 - 9 (Surge voltage 12.5V, 100ms max)		9 - 18 (Surge voltage 25V, 100ms max)		18 - 36 (Surge voltage 50V, 100ms max)		36 - 76 (Surge voltage 100V, 100ms max)		
	CURRENT[A] *2	1.40typ	1.40typ	0.57typ	0.57typ	0.29typ	0.29typ	0.14typ	0.14typ	
	EFFICIENCY[%] *2	86typ	86typ	88typ	88typ	88typ	88typ	88typ	88typ	
OUTPUT	VOLTAGE[V]	±12 or +24	±15 or +30	±12 or +24	±15 or +30	±12 or +24	±15 or +30	±12 or +24	±15 or +30	
	CURRENT[A]	0.25	0.2	0.25	0.2	0.25	0.2	0.25	0.2	
	LINE REGULATION[mV]	60max	75max	60max	75max	60max	75max	60max	75max	
	LOAD REGULATION[mV]	*3	480max	600max	480max	600max	480max	600max	480max	600max
		*4	600max	750max	600max	750max	600max	750max	600max	750max
	RIPPLE[mVp-p] *5	150max	150max	150max	150max	150max	150max	150max	150max	
	RIPPLE NOISE[mVp-p] *5	200max	200max	200max	200max	200max	200max	200max	200max	
	TEMPERATURE REGULATION[mV]	-20 to +70°C	210max	260max	210max	260max	210max	260max	210max	260max
		-40 to +70°C	320max	390max	320max	390max	320max	390max	320max	390max
	START-UP TIME[ms]	20max (Minimum input, I _o =100%)								
OUTPUT VOLTAGE ADJUSTMENT RANGE	Fixed (TRM pin open) +10%, -5% adjustable by external VR									
OUTPUT VOLTAGE SETTING[V]	11.64 - 12.36	14.55 - 15.45	11.64 - 12.36	14.55 - 15.45	11.64 - 12.36	14.55 - 15.45	11.64 - 12.36	14.55 - 15.45		
PROTECTION CIRCUIT AND OTHERS	OVERCURRENT PROTECTION	Works over 105% of rating and recovers automatically								
	REMOTE ON/OFF	Provided (Negative logic L : ON, H :OFF)								
ISOLATION	INPUT-OUTPUT	AC500V 1minute, Cutoff current=10mA, DC500V 50MΩ min (20±15C)								
ENVIRONMENT	OPERATING TEMP., HUMID. AND ALTITUDE	-40 to +95°C, 20 to 95%RH (Non condensing) (Refer to "Derating"), 5,000m (16,400feet) max								
	STORAGE TEMP., HUMID. AND ALTITUDE	-40 to +100°C, 20 to 95%RH (Non condensing), 9,000m (30,000feet) max								
	VIBRATION	10 - 55Hz 98.0m/s ² (10G), 3minute period, 60minutes each along X, Y and Z axis								
	IMPACT	490.3m/s ² (50G) 11ms, once each along X, Y and Z axis								
SAFETY	AGENCY APPROVALS	UL62368-1 C-UL (equivalent to CAN / CSA-C22.2 No.62368-1), EN62368-1								
OTHERS	CASE SIZE/WEIGHT	24.0 × 8.5 × 17.3mm [0.94 × 0.33 × 0.68 inches] (W × H × D) / 5g max								
	COOLING METHOD	Convection/Forced air								

*1 Single output +24V, +30V with no use of COM.
 *2 Rated input 5V, 12V, 24V or 48V DC I_o=100%
 *3 Symmetrical loading from 20% to 100%.
 *4 Symmetrical loading from 0% to 100%.
 *5 Ripple and Ripple Noise is measured by using test board with ceramic capacitor 1μF at 25mm from output pins.
 * Parallel operation with other model is not possible.

Block diagram

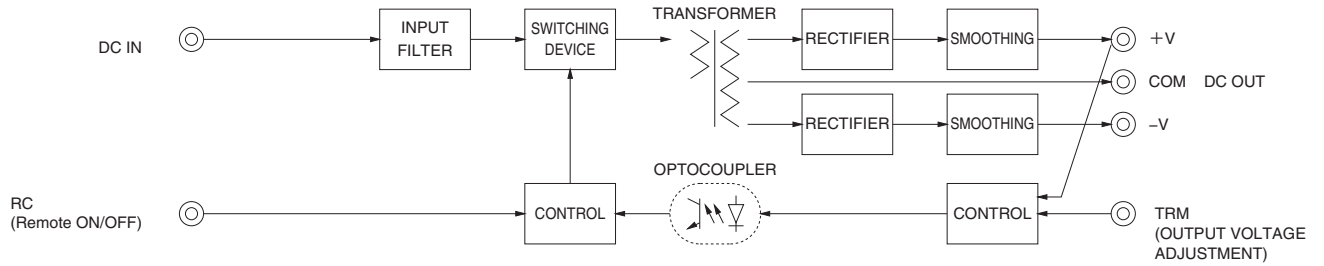

External view

1. SMD(type B)

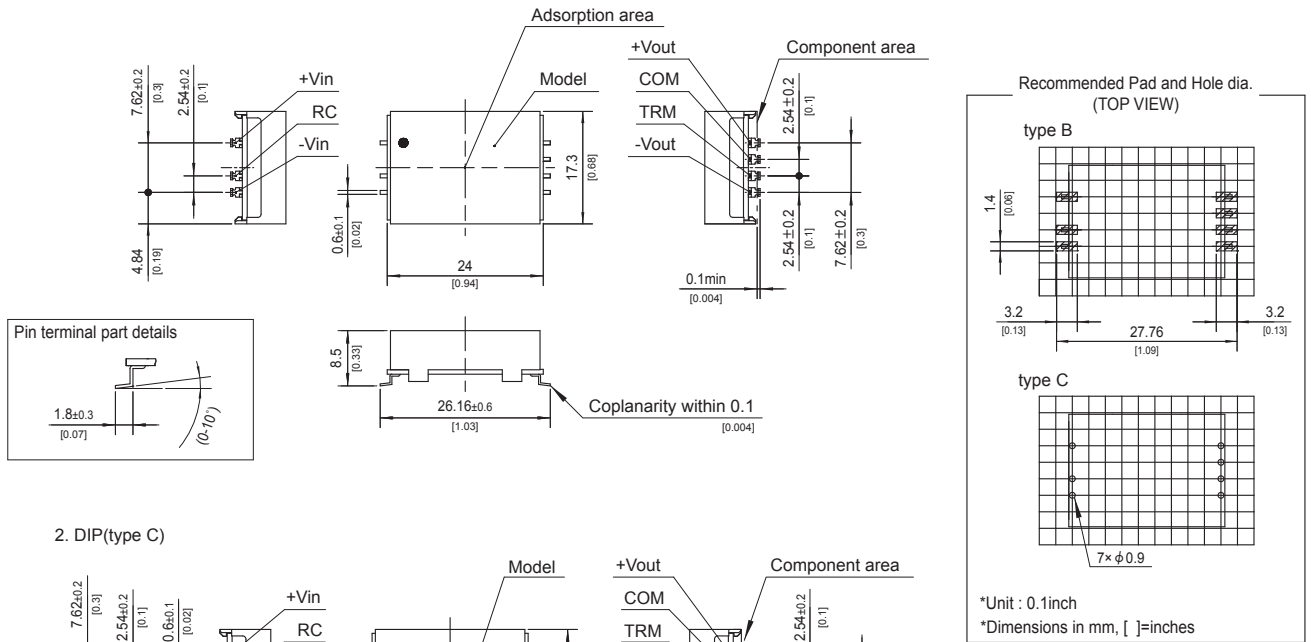

2. DIP(type C)

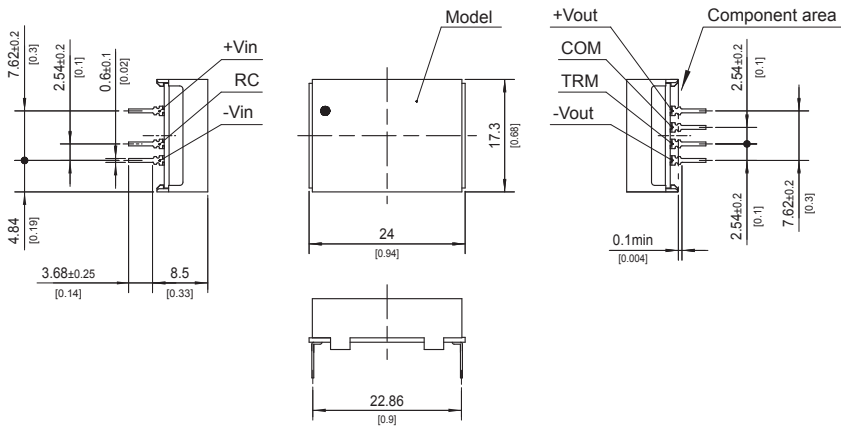

- ※ Tolerance ± 0.5 [± 0.02]
- ※ Dimensions in mm, []= inches
- ※ Pin terminal thickness : 0.3 ± 0.1 [0.012]
- ※ Pin terminal material : Copper alloy
- ※ Plating treatment of terminal : Lead free plating
- ※ Case material : PPS
- ※ Weight : 5g max

MUS10

MU S 10 12 05 B - □

① ② ③ ④ ⑤ ⑥ ⑦

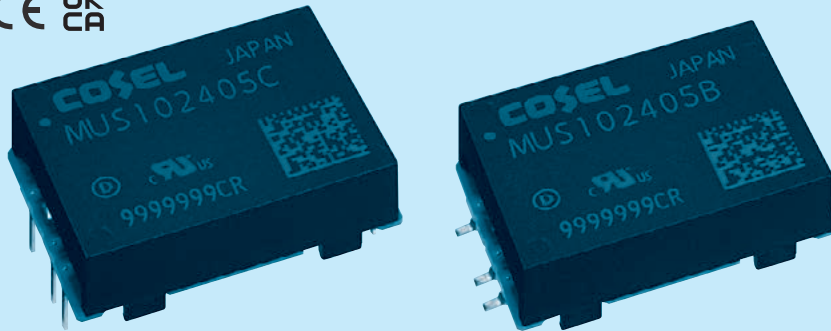

- ① Series name
- ② Single output
- ③ Output wattage
- ④ Input voltage
- ⑤ Output voltage
- ⑥ Mounting type
B :SMD
C :DIP
- ⑦ Optional
G :Capacitor between Input and Output is removed.

MODEL	MUS10053R3	MUS100505	MUS100512	MUS100515	MUS10123R3	MUS101205	MUS101212	MUS101215	
MAX OUTPUT WATTAGE[W]	8.58	10.0	10.8	10.5	8.58	10.0	10.8	10.5	
DC OUTPUT	VOLTAGE[V]	3.3	5	12	15	3.3	5	12	15
	CURRENT[A]	2.6	2	0.9	0.7	2.6	2	0.9	0.7

SPECIFICATIONS

	MODEL	MUS10053R3	MUS100505	MUS100512	MUS100515	MUS10123R3	MUS101205	MUS101212	MUS101215	
INPUT	VOLTAGE[VDC]	4.5 - 9 (Surge voltage 12.5V, 100ms max)				9 - 18 (Surge voltage 25V, 100ms max)				
	CURRENT[A]	*1 2.07typ	2.33typ	2.51typ	2.41typ	0.82typ	0.94typ	1.00typ	0.97typ	
	EFFICIENCY[%]	*1 83typ	86typ	86typ	87typ	87typ	89typ	90typ	90typ	
OUTPUT	VOLTAGE[V]	3.3	5	12	15	3.3	5	12	15	
	CURRENT[A]	2.6	2	0.9	0.7	2.6	2	0.9	0.7	
	LINE REGULATION[mV]	20max	20max	48max	60max	20max	20max	48max	60max	
	LOAD REGULATION[mV]	20max	20max	48max	60max	20max	20max	48max	60max	
	RIPPLE[mVp-p]	*2 120max	120max	150max	150max	120max	120max	150max	150max	
	RIPPLE NOISE[mVp-p]	*2 200max	200max	200max	200max	200max	200max	200max	200max	
	TEMPERATURE REGULATION[mV]	-20 to +50°C	50max	50max	150max	180max	50max	50max	150max	180max
		-40 to +50°C	80max	80max	240max	290max	80max	80max	240max	290max
	START-UP TIME[ms]	20max (Minimum input, Io=100%)								
	OUTPUT VOLTAGE ADJUSTMENT RANGE	Fixed (TRM pin open) +10%, -5% adjustable by external VR								
OUTPUT VOLTAGE SETTING[V]	3.21 - 3.42	4.90 - 5.21	11.64 - 12.36	14.55 - 15.45	3.21 - 3.42	4.90 - 5.21	11.64 - 12.36	14.55 - 15.45		
PROTECTION CIRCUIT AND OTHERS	OVERCURRENT PROTECTION	Works over 105% of rating and recovers automatically								
	REMOTE ON/OFF	Provided (Negative logic L : ON, H :OFF)								

MODEL	MUS10243R3	MUS102405	MUS102412	MUS102415	MUS10483R3	MUS104805	MUS104812	MUS104815	
MAX OUTPUT WATTAGE[W]	8.58	10.0	10.8	10.5	8.58	10.0	10.8	10.5	
DC OUTPUT	VOLTAGE[V]	3.3	5	12	15	3.3	5	12	15
	CURRENT[A]	2.6	2	0.9	0.7	2.6	2	0.9	0.7

SPECIFICATIONS

	MODEL	MUS10243R3	MUS102405	MUS102412	MUS102415	MUS10483R3	MUS104805	MUS104812	MUS104815	
INPUT	VOLTAGE[VDC]	18 - 36 (Surge voltage 50V, 100ms max)				36 - 76 (Surge voltage 100V, 100ms max)				
	CURRENT[A]	*1 0.41typ	0.47typ	0.50typ	0.49typ	0.20typ	0.24typ	0.25typ	0.24typ	
	EFFICIENCY[%]	*1 87typ	89typ	90typ	90typ	88typ	88typ	90typ	90typ	
OUTPUT	VOLTAGE[V]	3.3	5	12	15	3.3	5	12	15	
	CURRENT[A]	2.6	2	0.9	0.7	2.6	2	0.9	0.7	
	LINE REGULATION[mV]	20max	20max	48max	60max	20max	20max	48max	60max	
	LOAD REGULATION[mV]	20max	20max	48max	60max	20max	20max	48max	60max	
	RIPPLE[mVp-p]	*2 120max	120max	150max	150max	120max	120max	150max	150max	
	RIPPLE NOISE[mVp-p]	*2 200max	200max	200max	200max	200max	200max	200max	200max	
	TEMPERATURE REGULATION[mV]	-20 to +50°C	50max	50max	150max	180max	50max	50max	150max	180max
		-40 to +50°C	80max	80max	240max	290max	80max	80max	240max	290max
	START-UP TIME[ms]	20max (Minimum input, Io=100%)								
	OUTPUT VOLTAGE ADJUSTMENT RANGE	Fixed (TRM pin open) +10%, -5% adjustable by external VR								
OUTPUT VOLTAGE SETTING[V]	3.21 - 3.42	4.90 - 5.21	11.64 - 12.36	14.55 - 15.45	3.21 - 3.42	4.90 - 5.21	11.64 - 12.36	14.55 - 15.45		
PROTECTION CIRCUIT AND OTHERS	OVERCURRENT PROTECTION	Works over 105% of rating and recovers automatically								
	REMOTE ON/OFF	Provided (Negative logic L : ON, H :OFF)								

GENERAL SPECIFICATIONS

ISOLATION	INPUT-OUTPUT	AC500V 1minute, Cutoff current=10mA, DC500V 50MΩ min (20±15°C)
ENVIRONMENT	OPERATING TEMP., HUMID. AND ALTITUDE	-40 to +90°C, 20 to 95%RH (Non condensing) (Refer to "Derating"), 5,000m (16,400feet) max
	STORAGE TEMP., HUMID. AND ALTITUDE	-40 to +100°C, 20 to 95%RH (Non condensing), 9,000m (30,000feet) max
	VIBRATION	10 - 55Hz 98.0m/s ² (10G), 3minute period, 60minutes each along X, Y and Z axis
	IMPACT	490.3m/s ² (50G) 11ms, once each along X, Y and Z axis
SAFETY	AGENCY APPROVALS	UL62368-1 C-UL (equivalent to CAN / CSA-C22.2 No.62368-1), EN62368-1
OTHERS	CASE SIZE/WEIGHT	24.0×8.5×17.3mm [0.94×0.33×0.68 inches] (W×H×D) / 5g max
	COOLING METHOD	Convection/Forced air

- *1 Rated input 5V, 12V, 24V or 48V DC I_o=100%
- *2 Ripple and ripple noise is measured by using test board with ceramic capacitor 1μF at 25mm from output pins.
- * Parallel operation with other model is not possible.
- * MUW10xx12/MUW10xx15 is available as single output, +24V/+30V

Block diagram

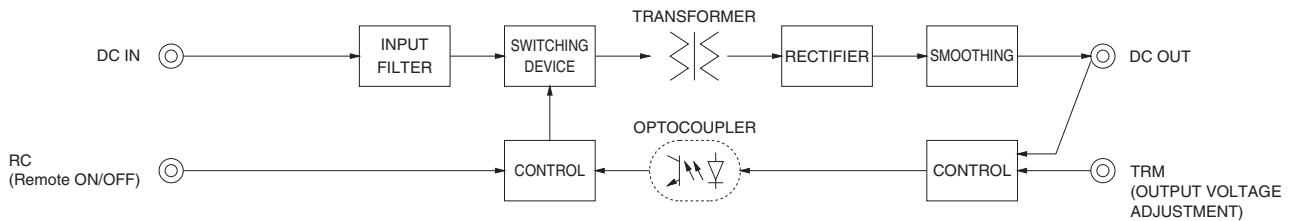

External view

1. SMD(type B)

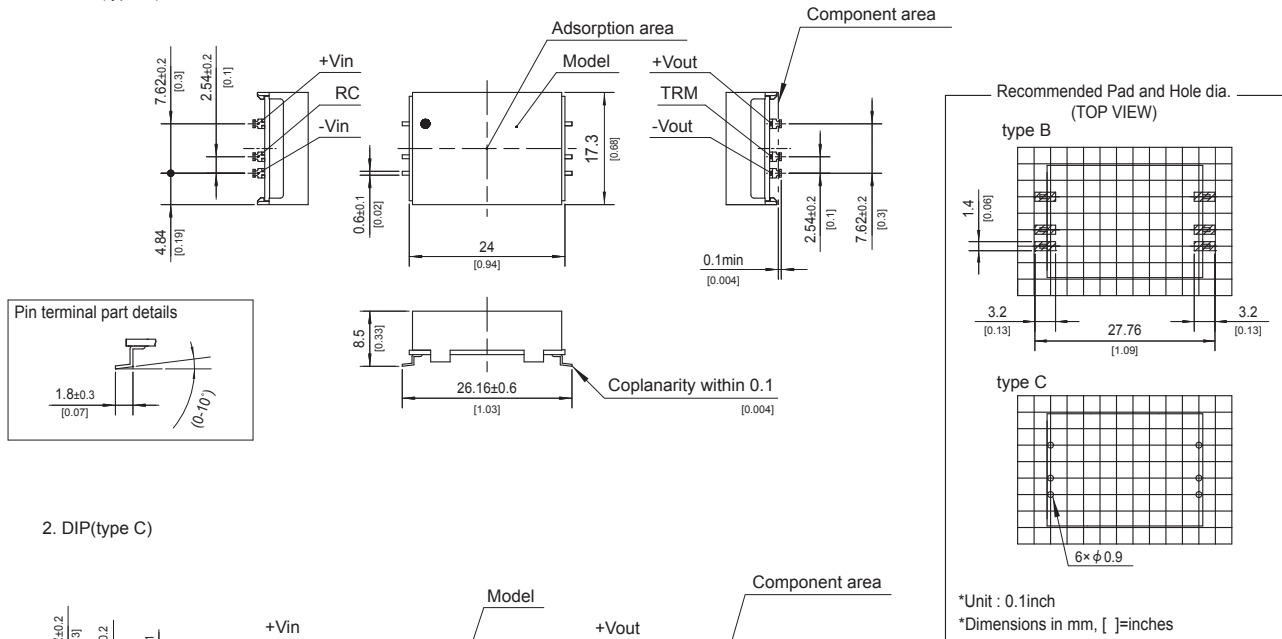

2. DIP(type C)

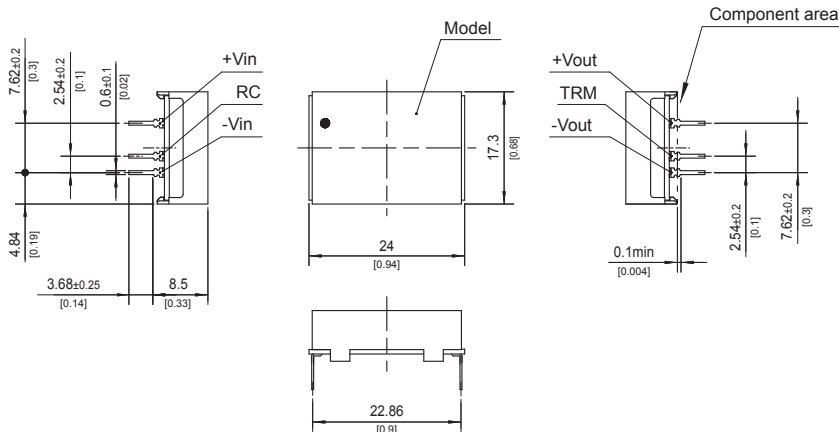

- ※ Tolerance -0.5 [-0.02]
- ※ Dimensions in mm, []= inches
- ※ Pin terminal thickness : 0.3-0.1 [0.012]
- ※ Pin terminal material : Copper alloy
- ※ Plating treatment of terminal : Lead free plating
- ※ Case material : PPS
- ※ Weight : 5g max

MUW10

MU W 10 12 12 B - □

① ② ③ ④ ⑤ ⑥ ⑦

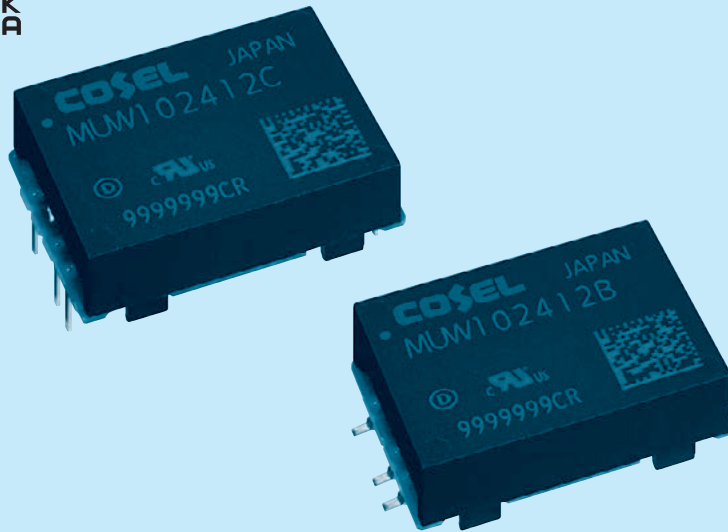

- ① Series name
- ② Dual output
- ③ Output wattage
- ④ Input voltage
- ⑤ Output voltage
- ⑥ Mounting type
B : SMD
C : DIP
- ⑦ Optional
G : Capacitor between Input and Output is removed.

MODEL	MUW100512	MUW100515	MUW101212	MUW101215	MUW102412	MUW102415	MUW104812	MUW104815	
MAX OUTPUT WATTAGE[W]	10.8	10.5	10.8	10.5	10.8	10.5	10.8	10.5	
DC OUTPUT	VOLTAGE[V] *1	±12 or +24	±15 or +30	±12 or +24	±15 or +30	±12 or +24	±15 or +30	±12 or +24	±15 or +30
	CURRENT[A]	0.45	0.35	0.45	0.35	0.45	0.35	0.45	0.35

SPECIFICATIONS

	MODEL	MUW100512	MUW100515	MUW101212	MUW101215	MUW102412	MUW102415	MUW104812	MUW104815	
INPUT	VOLTAGE[VDC]	4.5 - 9 (Surge voltage 12.5V, 100ms max)		9 - 18 (Surge voltage 25V, 100ms max)		18 - 36 (Surge voltage 50V, 100ms max)		36 - 76 (Surge voltage 100V, 100ms max)		
	CURRENT[A] *2	2.52typ	2.45typ	1.03typ	1.00typ	0.51typ	0.50typ	0.25typ	0.25typ	
	EFFICIENCY[%] *2	86typ	86typ	88typ	88typ	89typ	89typ	89typ	89typ	
OUTPUT	VOLTAGE[V]	±12 or +24	±15 or +30	±12 or +24	±15 or +30	±12 or +24	±15 or +30	±12 or +24	±15 or +30	
	CURRENT[A]	0.45	0.35	0.45	0.35	0.45	0.35	0.45	0.35	
	LINE REGULATION[mV]	60max	75max	60max	75max	60max	75max	60max	75max	
	LOAD REGULATION[mV]	*3	480max	600max	480max	600max	480max	600max	480max	600max
		*4	600max	750max	600max	750max	600max	750max	600max	750max
	RIPPLE[mVp-p] *5	150max	150max	150max	150max	150max	150max	150max	150max	
	RIPPLE NOISE[mVp-p] *5	200max	200max	200max	200max	200max	200max	200max	200max	
	TEMPERATURE REGULATION[mV]	-20 to +50°C	210max	260max	210max	260max	210max	260max	210max	260max
		-40 to +50°C	320max	390max	320max	390max	320max	390max	320max	390max
	START-UP TIME[ms]	20max (Minimum input, Io=100%)								
OUTPUT VOLTAGE ADJUSTMENT RANGE	Fixed (TRM pin open) +10%, -5% adjustable by external VR									
OUTPUT VOLTAGE SETTING[V]	11.64 - 12.36	14.55 - 15.45	11.64 - 12.36	14.55 - 15.45	11.64 - 12.36	14.55 - 15.45	11.64 - 12.36	14.55 - 15.45		
PROTECTION CIRCUIT AND OTHERS	OVERCURRENT PROTECTION	Works over 105% of rating and recovers automatically								
	REMOTE ON/OFF	Provided (Negative logic L : ON, H : OFF)								
ISOLATION	INPUT-OUTPUT	AC500V 1minute, Cutoff current=10mA, DC500V 50MΩ min (20±15C)								
ENVIRONMENT	OPERATING TEMP., HUMID. AND ALTITUDE	-40 to +90°C, 20 to 95%RH (Non condensing) (Refer to "Derating"), 5,000m (16,400feet) max								
	STORAGE TEMP., HUMID. AND ALTITUDE	-40 to +100°C, 20 to 95%RH (Non condensing), 9,000m (30,000feet) max								
	VIBRATION	10 - 55Hz 98.0m/s ² (10G), 3minute period, 60minutes each along X, Y and Z axis								
	IMPACT	490.3m/s ² (50G) 11ms, once each along X, Y and Z axis								
SAFETY	AGENCY APPROVALS	UL62368-1 C-UL (equivalent to CAN / CSA-C22.2 No.62368-1), EN62368-1								
OTHERS	CASE SIZE/WEIGHT	24.0 × 8.5 × 17.3mm [0.94 × 0.33 × 0.68 inches] (W × H × D) / 5g max								
	COOLING METHOD	Convection/Forced air								

*1 Single output +24V, +30V with no use of COM.
 *2 Rated input 5V, 12V, 24V or 48V DC Io=100%
 *3 Symmetrical loading from 20% to 100%.
 *4 Symmetrical loading from 0% to 100%.
 *5 Ripple and Ripple Noise is measured by using test board with ceramic capacitor 1μF at 25mm from output pins.
 * Parallel operation with other model is not possible.

Block diagram

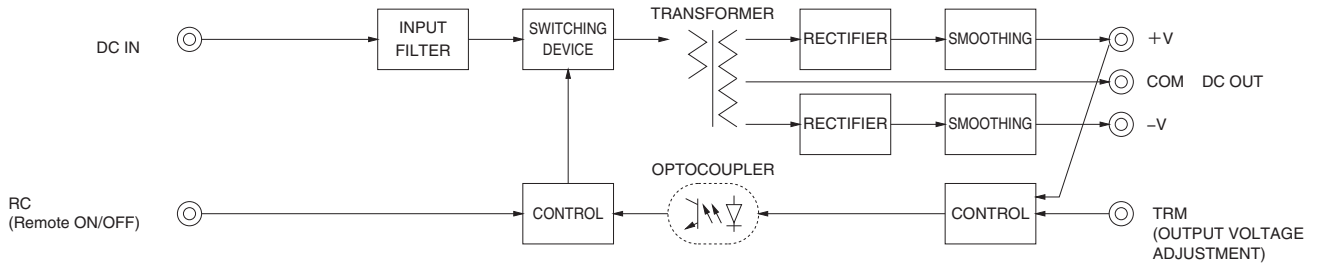

External view

1. SMD(type B)

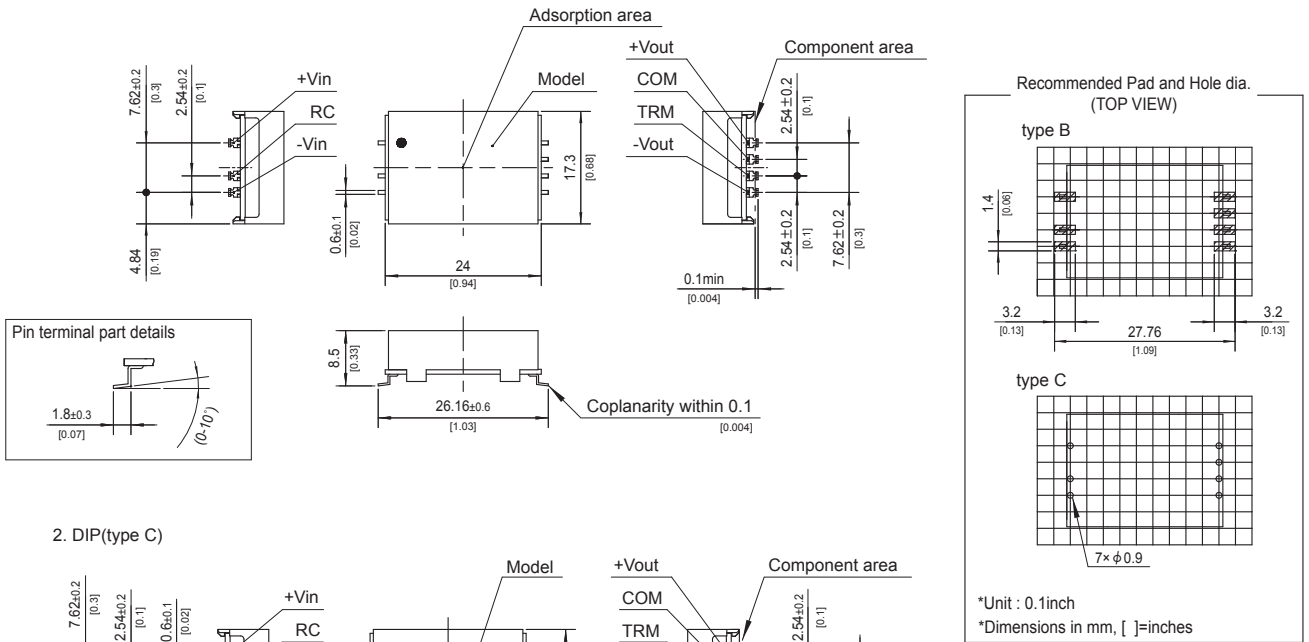

2. DIP(type C)

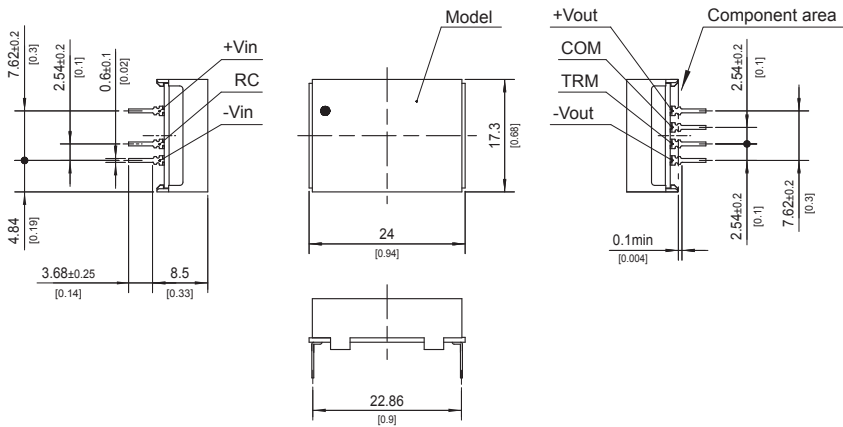

- ※ Tolerance ± 0.5 [± 0.02]
- ※ Dimensions in mm, []= inches
- ※ Pin terminal thickness : 0.3 ± 0.1 [0.012]
- ※ Pin terminal material : Copper alloy
- ※ Plating treatment of terminal : Lead free plating
- ※ Case material : PPS
- ※ Weight : 5g max

Pin Configuration

MU Single Output

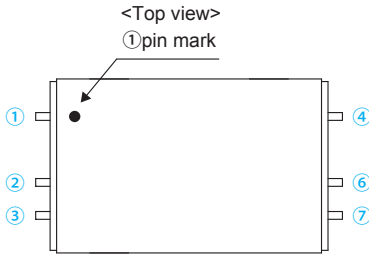

Pin No.	Pin Terminal Name	Function
①	+Vin	+DC Input
②	RC	Remote ON/OFF (excluding 1R5)
③	-Vin	-DC Input
④	+Vout	+DC Output
⑤	COM	GND of Output Voltage (for Dual Output)
⑥	TRM	Output Voltage Adjustment (please see Instruction Manual 1.4)
⑦	-Vout	-DC Output

MU Dual (\pm) Output

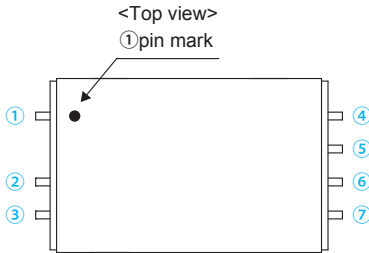

Assembling and Installation Method

Installation

- You can install the units in any direction. Place them in such a way that there is enough ventilation so that heat does not get accumulated around them.
- Do not place land or pattern layouts in the hatched area shown in below. Doing so may cause insulation failure on the PCB surface on which the power supply is mounted.

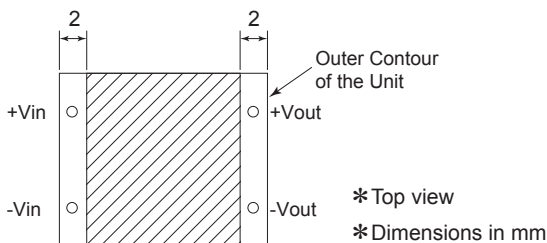

Area where Pattern Layout should not be Placed for MU

Automatic Mounting (TYPE: B)

- To mount MU series automatically, use the central area of the case as a pickup point. If the bottom dead point of a suction nozzle is too low when mounting, excessive force is applied to the internal components, which could cause damage. Please mount carefully. Please see the External View for details of the pickup point.

Hand Mounting (TYPE: B, C)

- To mount MU series manually, it must be push the center of case.
- Due to prevent failure, PS should not be pull after soldering with PCB.

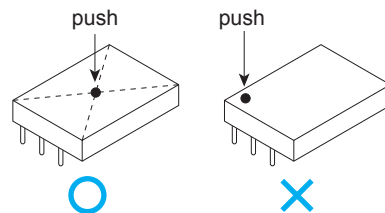

Assembling and Installation Method

Soldering Conditions

(1) Reflow Soldering

- Right figure shows conditions for the reflow soldering for MU series. Please make sure that the temperatures of pin terminals +Vin and -Vout shown in right figure, do not exceed the temperatures shown in right figure.
- If time or temperature of the reflow soldering goes beyond the conditions, reliability of internal components may be compromised. Please use the unit under the recommended reflow conditions.
- With this reflow profile, internal solder melts down. When transporting the unit within the reflow oven, please do not give vibration to the unit.
- Please avoid reflow soldering after applying adhesive or coating to the unit.
- You can reflow solder up to 1 time. Do not reflow solder when the power supply is mounted on the back surface of the PCB because the unit may drop.

- (2) Flow Soldering : 260°C 15 seconds or less
- (3) Soldering Iron : maximum 360°C 5 seconds or less



*View from Above

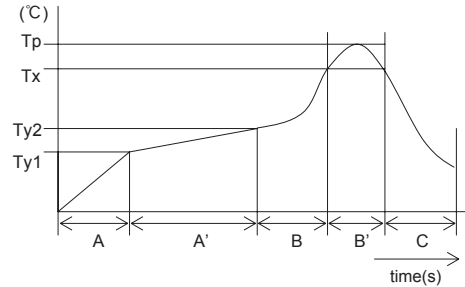

A	1.0 - 5.0°C/s
A'	Ty1 : 160 ±20°C
	Ty2 : 180 ±20°C
	Ty1 - Ty2 : 120s max
B	1.0 - 5.0°C/s
B'	Tp : Max 245°C 10s max
	Tx : 220°C or more : 70s max
C	1.0 - 5.0°C/s

Stress to Pin Terminals

- If too much stress is applied to input/output pin terminals of the power supply, internal connection may come down. If you apply stress as shown below, please keep it at 19.6N (2kgf) or less vertically.
- Input/output pin terminals are soldered to the PCB internally. Do not pull or bend a lead powerfully.
- If it is expected that stress is applied to the input/output pin terminals due to vibration or impact, reduce the stress to the pin terminals by taking such measures as fixing the unit to the PCB by silicone rubber, etc.

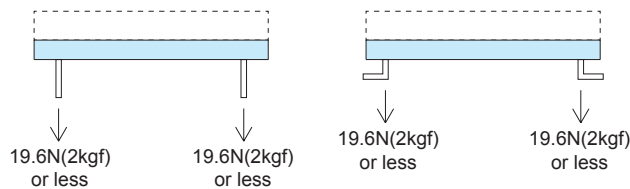

Strength of Input/Output Pin Terminals for MU

Derating

Ambient temperature derating curve

- The ambient temperature derating curve of each model are shown in the figure below.
- Keep the temperature at the center of the case below the temperature shown in the instruction manual 7.
- Model name

The following letters/numbers are entered in □.

ex.) . . . MU□612□
 S,W 3R3,05,12,15

MU1R5

(1) In the case of Convection Cooling (Reference)

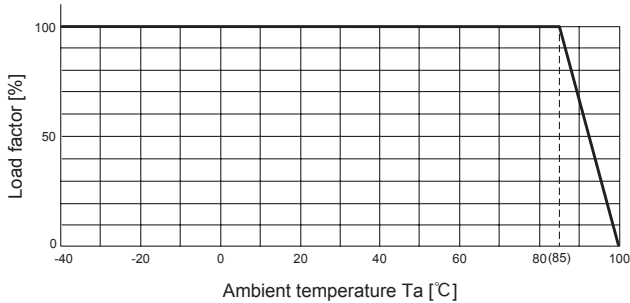

(2) In the case of Forced Air Cooling (1.0m/s) (Reference)

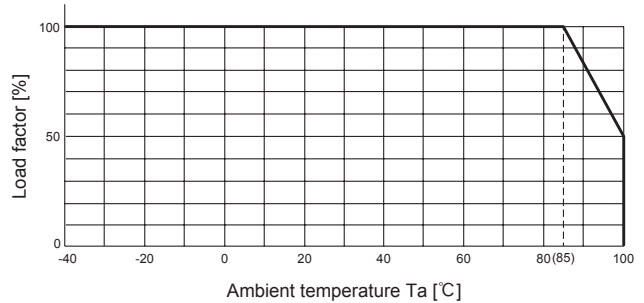

MU3

(1) In the case of Convection Cooling (Reference)

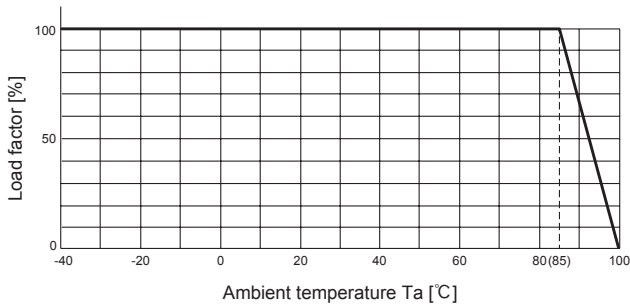

(2) In the case of Forced Air Cooling (1.0m/s) (Reference)

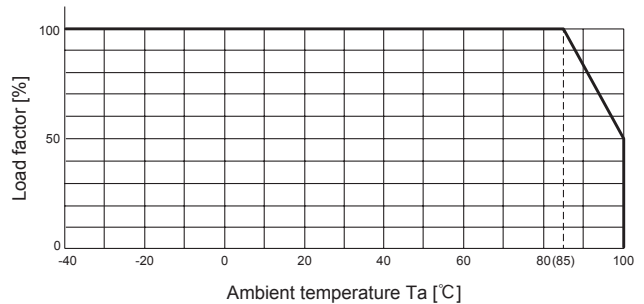

MU6

(1) In the case of Convection Cooling (Reference)

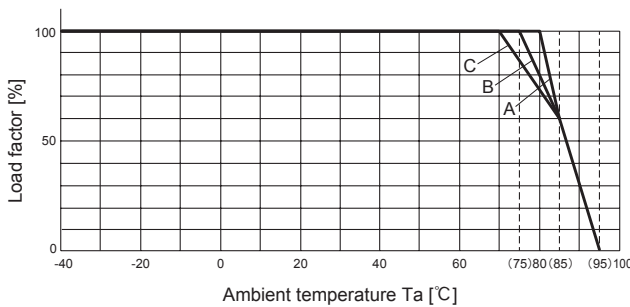

(2) In the case of Forced Air Cooling (1.0m/s) (Reference)

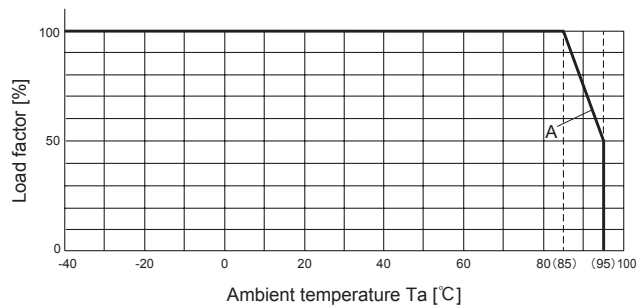

Output Voltage Model name	3.3	5	12	15	±12	±15
MU□605□	C	C	B	B	B	B
MU□612□	C	B	A	A	A	A
MU□624□	C	B	A	A	A	A
MU□648□	C	B	A	A	A	A

Output Voltage Model name	3.3	5	12	15	±12	±15
MU□605□	A	A	A	A	A	A
MU□612□	A	A	A	A	A	A
MU□624□	A	A	A	A	A	A
MU□648□	A	A	A	A	A	A

Derating

MU10

(1) In the case of Convection Cooling (Reference)

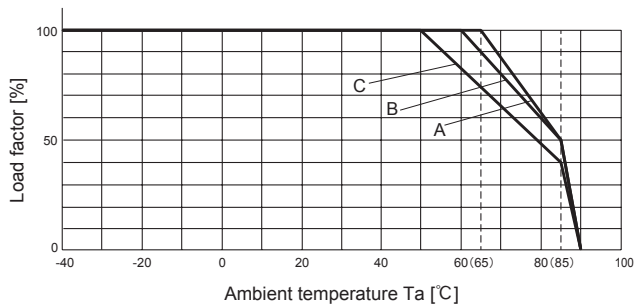

(2) In the case of Forced Air Cooling (1.0m/s) (Reference)

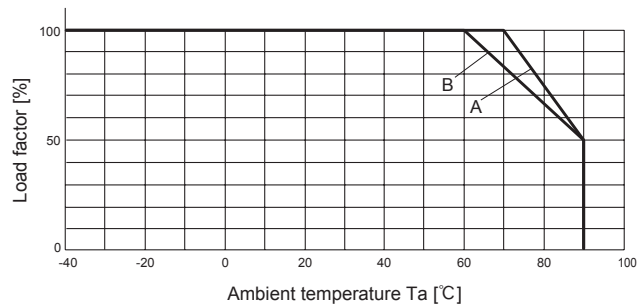

Output Voltage Model name	3.3	5	12	15	±12	±15
MU□1005□	C	C	C	C	C	C
MU□1012□	A	A	A	A	B	B
MU□1024□	A	A	A	A	A	A
MU□1048□	A	A	A	A	A	A

Output Voltage Model name	3.3	5	12	15	±12	±15
MU□1005□	B	B	B	B	B	B
MU□1012□	A	A	A	A	A	A
MU□1024□	A	A	A	A	A	A
MU□1048□	A	A	A	A	A	A

Instruction Manual

◆ It is necessary to read the "Instruction Manual" and "Before using our product" before you use our product.

Instruction Manual <https://www.cosel.co.jp/redirect/catalog/en/MUS/>
 Instruction Manual <https://www.cosel.co.jp/redirect/catalog/en/MUW/>
 Before using our product <https://en.cosel.co.jp/technical/caution/index.html>

MUS



MUW



NOTICE



Basic Characteristics Data

Model	Circuit method	Switching frequency [kHz] (reference)	Input current [A]	Inrush current protection	PCB/Pattern			Series/Parallel operation availability	
					Material	Single sided	Double sided	Series operation	Parallel operation
MU1R5	Flyback converter	420kHz	*1	-	glass fabric base,epoxy resin		Yes	Yes	*2
MU3	Flyback converter	420kHz	*1	-	glass fabric base,epoxy resin		Yes	Yes	*2
MU6	Flyback converter	420kHz	*1	-	glass fabric base,epoxy resin		Yes	Yes	*2
MU10	Flyback converter	420kHz	*1	-	glass fabric base,epoxy resin		Yes	Yes	*2

*1 Refer to Specification.

*2 Refer to Instruction Manual.

Mouser Electronics

Authorized Distributor

Click to View Pricing, Inventory, Delivery & Lifecycle Information:

[Cosel:](#)

[MUS34805C](#) [MUS34812B](#) [MUW34812C](#) [MUS32415C](#) [MUS3243R3C](#) [MUS1R51205C](#) [MUS1R51212B](#)
[MUS1R54812C](#) [MUS31205C](#) [MUW34812B](#) [MUS1R52412C](#) [MUS1R52415C](#) [MUS1R5243R3C](#) [MUW1R50512B](#)
[MUW31215C](#) [MUW32412C](#) [MUS1R5483R3C](#) [MUS1R50515C](#) [MUS1R51215B](#) [MUS1R5123R3B](#) [MUS30515C](#)
[MUS3053R3C](#) [MUS3123R3B](#) [MUS1R50505B](#) [MUS32405C](#) [MUW30515C](#) [MUS1R5123R3C](#) [MUS1R52405C](#)
[MUS30505B](#) [MUS30512B](#) [MUS32412C](#) [MUW1R51212B](#) [MUS1R51212C](#) [MUS1R54815C](#) [MUS30515B](#)
[MUS3123R3C](#) [MUS1R5053R3C](#) [MUS1R51205B](#) [MUS1R54812B](#) [MUS31212C](#) [MUW32415B](#) [MUS1R54805B](#)
[MUS31212B](#) [MUW1R54812C](#) [MUW32415C](#) [MUS1R50512C](#) [MUS31215B](#) [MUS32405B](#) [MUW1R51212C](#)
[MUW1R52412C](#) [MUW1R54815B](#) [MUW30512B](#) [MUS1R54815B](#) [MUS1R5483R3B](#) [MUS3483R3B](#) [MUW1R51215C](#)
[MUS1R50515B](#) [MUS1R5243R3B](#) [MUS34815C](#) [MUW1R52412B](#) [MUW1R54815C](#) [MUS1R50505C](#) [MUS30505C](#)
[MUW1R50512C](#) [MUW1R50515C](#) [MUW31212B](#) [MUS1R52405B](#) [MUS30512C](#) [MUS32412B](#) [MUS1R50512B](#)
[MUW1R50515B](#) [MUW31212C](#) [MUS1R5053R3B](#) [MUS1R51215C](#) [MUS1R52415B](#) [MUS34805B](#) [MUS3483R3C](#)
[MUW1R51215B](#) [MUW30512C](#) [MUS34812C](#) [MUS34815B](#) [MUW1R52415B](#) [MUS3053R3B](#) [MUS31215C](#)
[MUW32412B](#) [MUW34815C](#) [MUS3243R3B](#) [MUW31215B](#) [MUS1R54805C](#) [MUS31205B](#) [MUW1R52415C](#)
[MUW1R54812B](#) [MUW34815B](#) [MUS1R52412B](#) [MUS32415B](#) [MUW30515B](#) [MUS64812C](#) [MUW104812C](#)
[MUW64815C](#) [MUW100512C](#)