

The history of revision change for the specification

Document	RE V.	Modified date	Description
CYNVC-199-039	A0	2019.9.20	New Approval
CYNVC-199-039	A1	2020.7.11	1. Sep., 2019 -> Jul., 2020 2. add spec of R68, 1R5, 2R2, 3R3, 4R7 3. add curve of R68, 1R5, 2R2, 3R3, 4R7
CYNVC-199-039	A2	2020.11.22	1. Jul. -> Nov. 2. Add spec of 6R8
CYNVC-199-039	A3	2021.09.06	1. Nov., 2020 -> Sep., 2021 2. Update 2R2 SPEC & Curve Idc.(typ/max):2.7/2.3 -> 2.9/2.6 Isat.(typ/max):2.6/2.2 -> 3.4/2.9
CYNVC-199-039	A4	2022.07.12	1. Sep., 2021 -> Jul., 2022 2. Add spec and curve of 150
CYNVC-199-039	A5	2024.09.26	1. Jul., 2022 -> Sep., 2024 2. Add notice 'Shielded construction' in Features 3. Reflow Soldering : 217°C -> $\geq 217^{\circ}\text{C}$

### Power Choke Coil VCUW25201B MS5 type

AEC-Q200

#### ■ Features

High performance (Isat) realized by metal dust core

Low profile : 2.5mm x 2.0mm x 1.2mm

Low loss realized with low DCR

Compliance with RoHS and Halogen Free

Shielded construction

AEC-Q200 qualified

#### ■ Application

Automotive applications

#### ■ Outline Dimensions

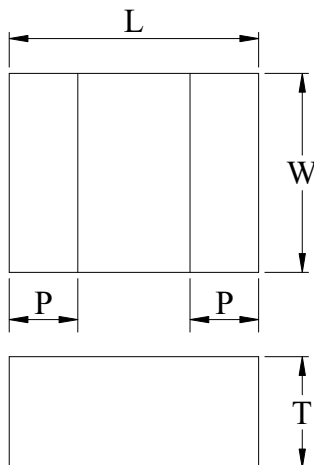

Code	Dimensions (mm)
L	2.5 ± 0.2
W	2.0 ± 0.2
T	1.2 Max.
P	0.7 ± 0.2

#### ■ Recommend Land Pattern Dimensions

The customer shall determine the land dimensions shown below after confirming and safety.

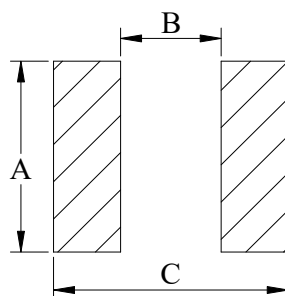

A	2.3
B	1.2
C	2.8

Unit : mm

### ■ Marking

The point on the top surface represents winding direction of choke.

Upside of Chip

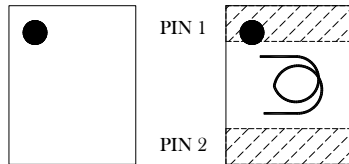

Coil clockwise around

### ■ Specifications

Part Number	L0 ◇ Inductance ( $\mu\text{H}$ ) @ (0A)	R <sub>dc</sub> (m $\Omega$ ) ◇		Heat Rating Current DC Amps. I <sub>dc</sub> (A)		Saturation Current DC Amps. I <sub>sat</sub> (A)		Rated Voltage (V)
		Typical	Maximum	Typical	Maximum	Typical	Maximum	Maximum
VCUW25201B-R47MS5	0.47	21.0	26.0	4.7	4.0	6.5	5.6	40
VCUW25201B-R68MS5	0.68	30.0	36.0	4.0	3.6	5.2	4.8	40
VCUW25201B-1R0MS5	1.0	33.0	40.0	3.8	3.4	4.1	3.5	40
VCUW25201B-1R5MS5	1.5	58.0	72.0	2.9	2.6	3.9	3.3	40
VCUW25201B-2R2MS5	2.2	70.0	84.0	2.9	2.6	3.4	2.9	40
VCUW25201B-3R3MS5	3.3	150.0	180.0	1.6	1.4	2.6	2.3	40
VCUW25201B-4R7MS5	4.7	175.0	210.0	1.5	1.3	2.2	2.0	20
VCUW25201B-6R8MS5	6.8	320.0	385.0	1.1	1.0	1.9	1.7	20
VCUW25201B-150MS5	15.0	800.0	1000.0	0.60	0.54	1.4	1.2	20

◇ : Significant Characteristic

Note 1. : Inductance tolerance  $\pm 20\%$

Note 2. : All test data is referenced to 25°C ambient.

Note 3. : Test condition; 1MHz, 1.0V<sub>rms</sub>

Note 4. : I<sub>dc</sub> : DC current (A) that will cause an approximate  $\Delta T$  of 40°C

Note 5. : I<sub>sat</sub> : DC current (A) that will cause L0 to drop approximately 30%

Note 6. : Operating temperature range -55°C to +155°C

Note 7. : The part temperature (ambient + temp rise) should not exceed 155°C under the worst case operating conditions. Circuit design, component placement, PCB trace size and thickness, airflow and other cooling provision all affect the part temperature. Part temperature should be verified in the end application.

Note 8. : The rated current as listed is either the saturation current or the heating current depending on which value is lower.

Note 9. : Cleaning process note

(a) If this power choke is dipped in the cleaning agent, such as toluene, xylene, ketone, and ether system, there is a possibility that the performance decreases greatly.

(b) The high power ultrasonic washing may damage the choke body.

(c) Please contact us if you need the cleaning via the above agents or ultrasonic washing.

Note 10. : If you require another part number, please contact with us.

### Current Characteristic

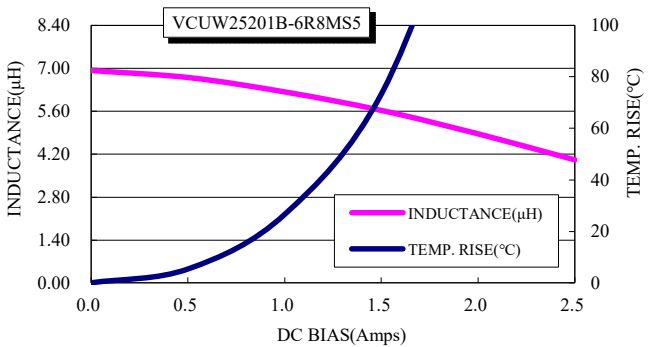
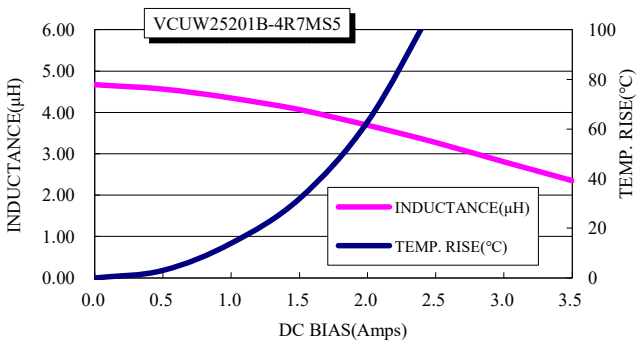
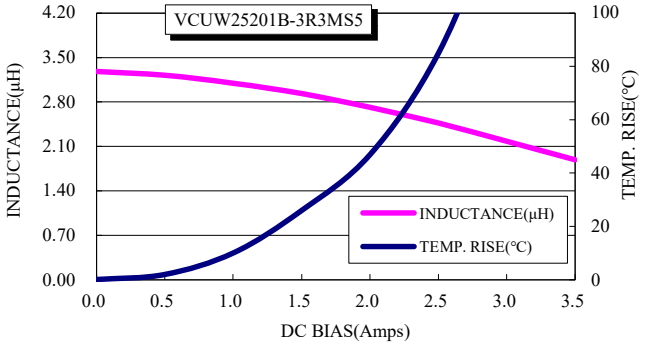
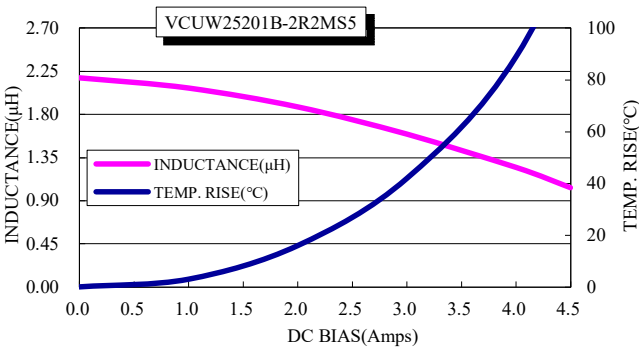
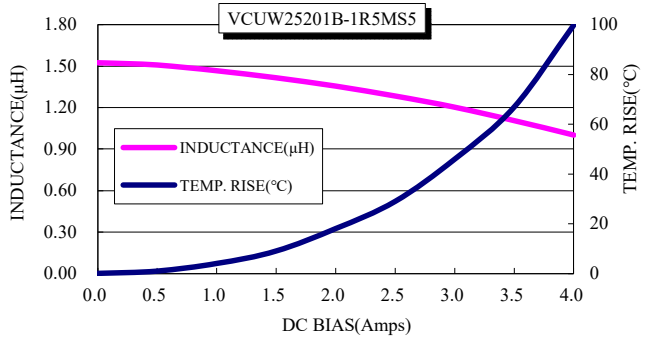
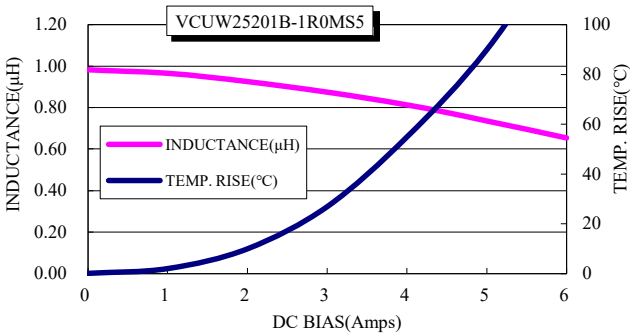
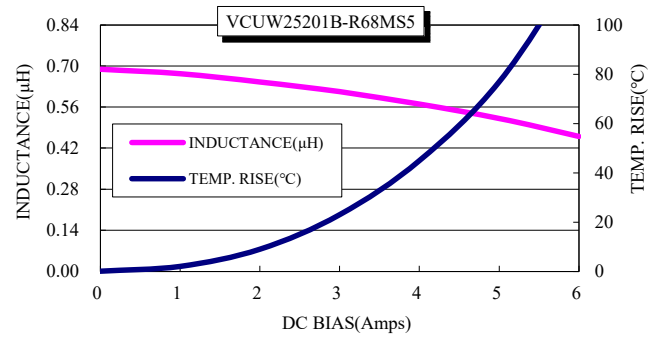
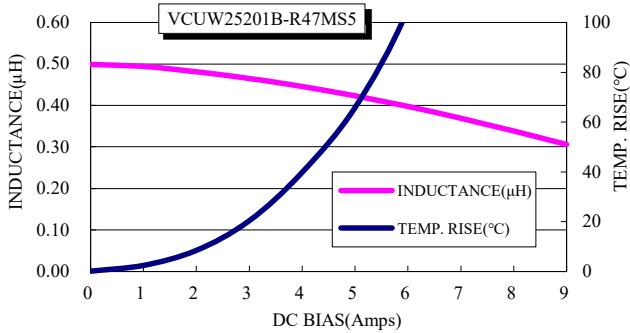

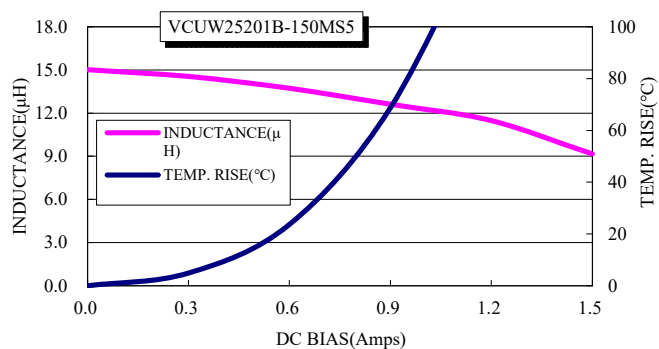

**■ Packaging**

(1) Tape packaging dimensions

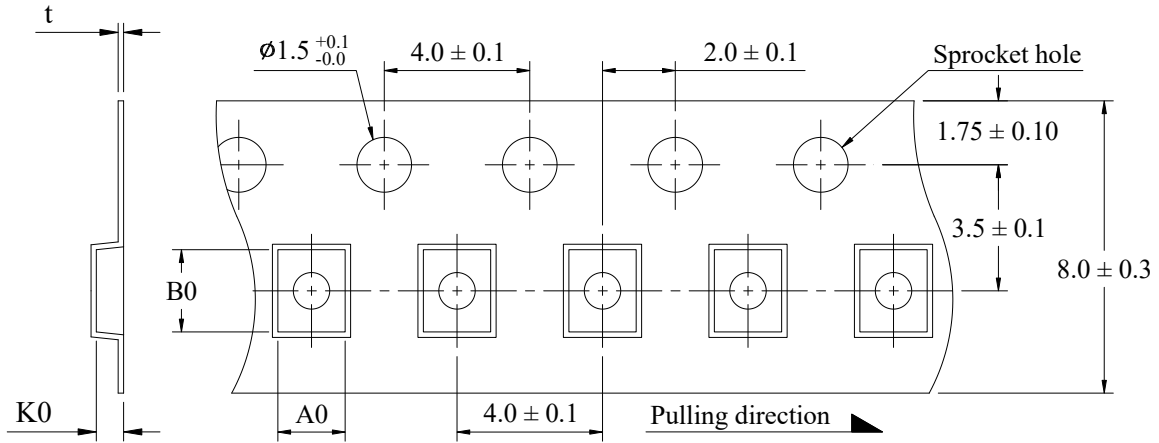

Dimensions Code (mm)				Units/Reel
A0	B0	K0	t	
2.35 ± 0.10	2.80 ± 0.10	1.35 ± 0.10	0.25 ± 0.05	2,000

(2) Tape direction

The direction shall be seen from the top cover tape side.

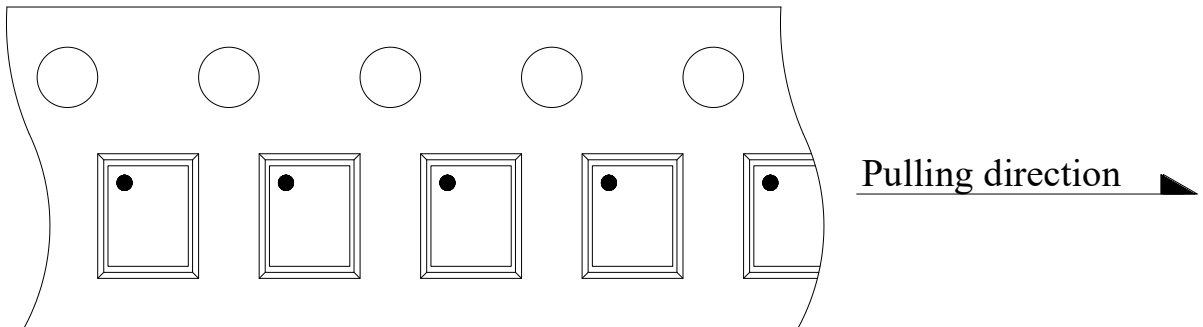

(3) Reel dimensions

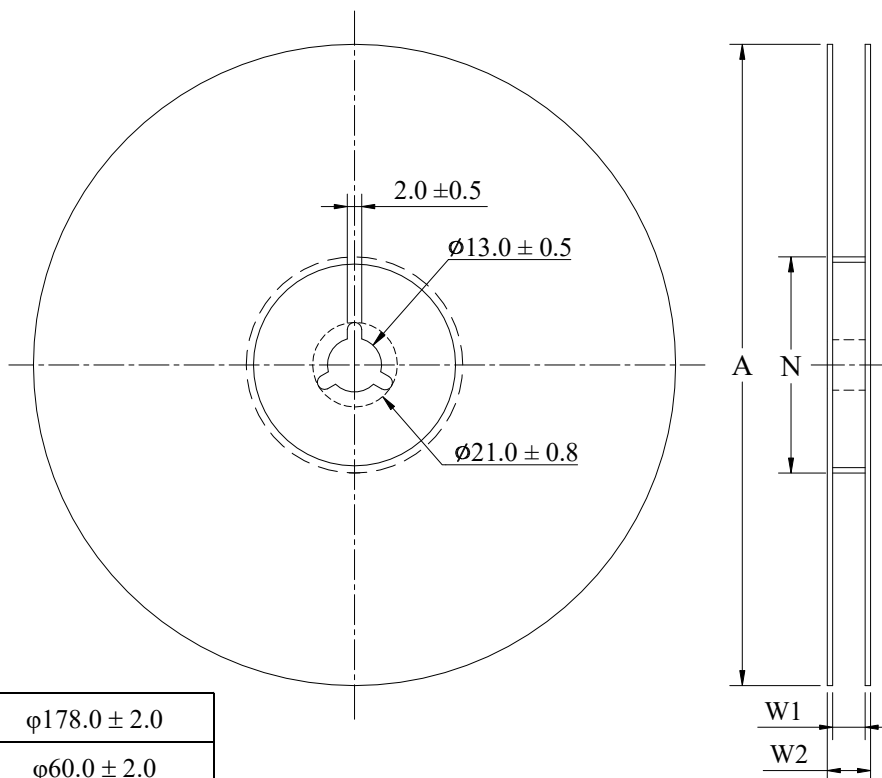

A	$\phi 178.0 \pm 2.0$
N	$\phi 60.0 \pm 2.0$
W1	$9.0 \pm 0.3$
W2	$11.4 \pm 1.0$

Unit : mm

(4) Peel force of top cover tape

The peel speed shall be about 300 mm/minute.

The peel force of top cover tape shall be between 0.1 to 0.7N.

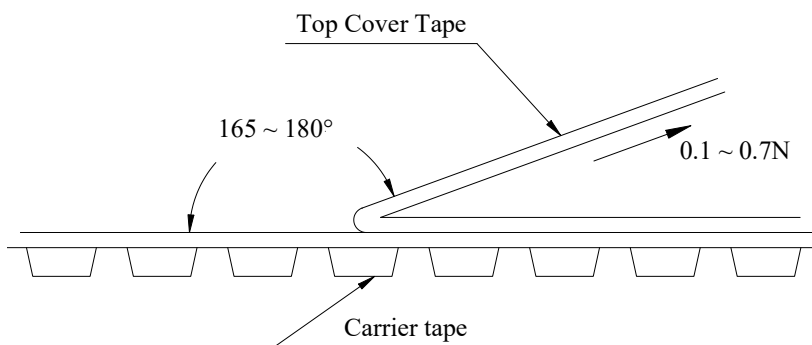

■ Reflow Profile

Power Choke Coil Type

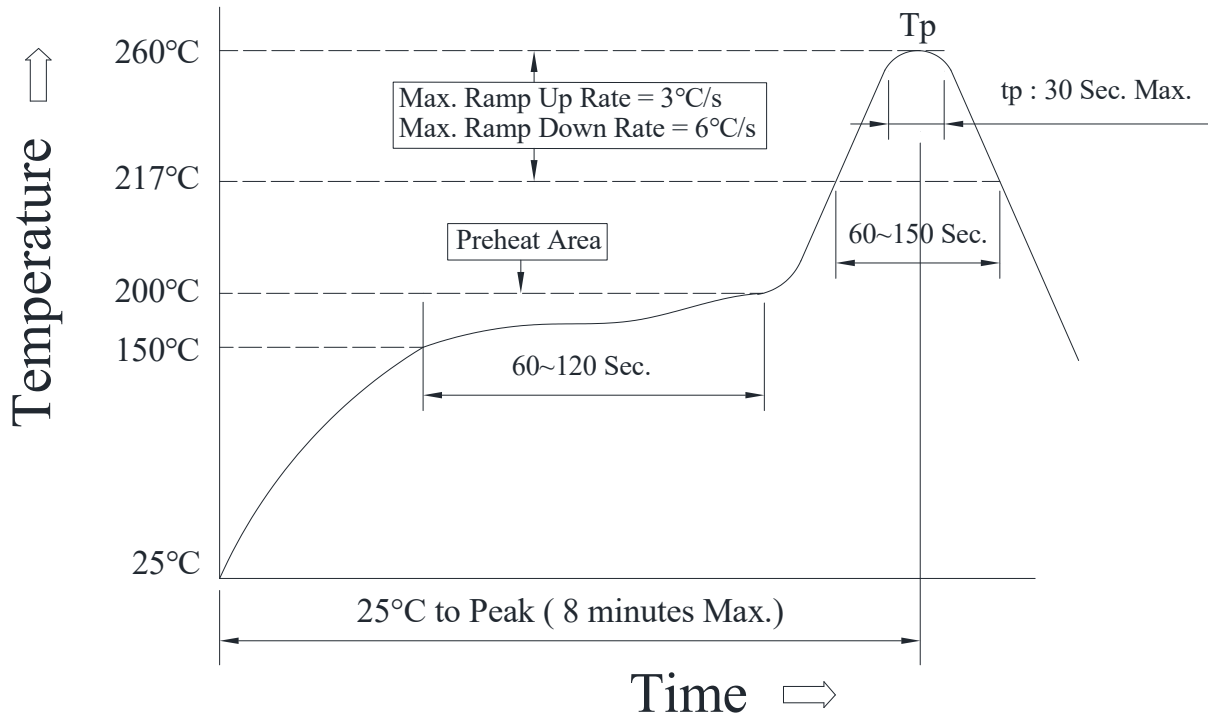

(1) Reflow soldering method :

Reflow Soldering	Tp : 255~260°C	Max. 30 seconds ( tp )
	≥ 217°C	60~150 seconds
Preheat	150~200°C	60~120 seconds
Time 25°C to peak temperature	8 minutes Max.	

(2) Soldering iron method : 350 ± 5°C, 3 seconds Max.

# Mouser Electronics

Authorized Distributor

Click to View Pricing, Inventory, Delivery & Lifecycle Information:

[Cyntec:](#)

[VCUW25201B-3R3MS5](#) [VCUW25201B-1R0MS5](#) [VCUW25201B-2R2MS5](#) [VCUW25201B-1R5MS5](#) [VCUW25201B-6R8MS5](#) [VCUW25201B-4R7MS5](#) [VCUW25201B-150MS5](#) [VCUW25201B-R47MS5](#) [VCUW25201B-R68MS5](#)