

The history of revision change for the specification

Document	REV.	Modified date	Description
CYNVC-176-004	A0	2017.06.05	New Approval
CYNVC-176-004	A1	2017.06.19	1. Add spec of R47, R68, 5R6, 150 2. Add curve of R47, R68, 5R6, 150
CYNVC-176-004	A2	2017.09.07	1. Jun. -> Sep. 2. Remove spec of R47, R68, 5R6, 150 3. Remove curve of R47, R68, 5R6, 150
CYNVC-176-004	A3	2017.11.01	1. Add curve of R15, R47 2. Add spec of R47 3. Sep. -> Nov.
CYNVC-176-004	A4	2018.03.13	1 Add "AEC-Q200" logo on page 2 2. Nov., 2017 -> Mar., 2018
CYNVC-176-004	A5	2018.10.19	1. Mar. -> Oct. 2. Remove spec & curve of 100 3. Specifications add Rated voltage on page 3
CYNVC-176-004	A6	2019.01.17	1. Add spec of R33 2. Oct., 2018 -> Jan., 2019
CYNVC-176-004	A7	2019.07.16	1. Jan. -> Jul. 2. Update R33 Isat Max. 8.5 -> 8.6
CYNVC-176-004	A8	2019.09.09	1. Jul. -> Sep. 2. Add curve of R33
CYNVC-176-004	A9	2019.10.30	1. Sep. -> Oct. 2. Update Land Pattern B: 1.2 -> 1.8; C: 3.5 -> 3.7
CYNVC-176-004	B0	2020.03.18	1. Add spec & curve of 100 2. Oct., 2019 -> Mar., 2020
CYNVC-176-004	B1	2020.05.27	1. Mar. -> May 2. Add spec & curve of 150
CYNVC-176-004	B2	2020.10.21	1. May -> Oct. 2. Add spec & curve of R22, R68
CYNVC-176-004	B3	2024.09.26	1. Oct., 2020 -> Sep., 2024 2. Add notice 'Shielded construction' in Features 3. Reflow Soldering : 217°C -> ≥217°C

Power Choke Coil VCTA32251B MS6 type

**AEC-Q200**

■ Features

- High performance (Isat) realized by metal dust core
- Low profile : 3.2mm x 2.5mm x 1.2mm
- Low loss realized with low DCR
- Compliance with RoHS and Halogen Free
- Shielded construction
- AEC-Q200 qualified

■ Application

Automotive applications

■ Outline Dimensions

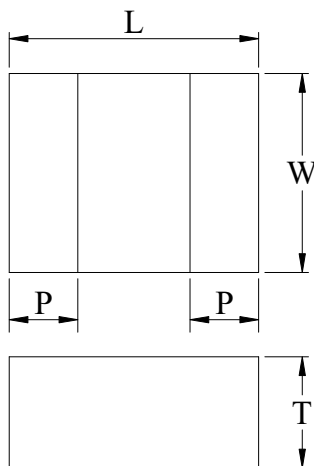

Code	Dimensions (mm)
L	3.2 ± 0.2
W	2.5 ± 0.2
T	1.2 Max.
P	0.7 ± 0.2

■ Recommend Land Pattern Dimensions

The customer shall determine the land dimensions shown below after confirming and safety.

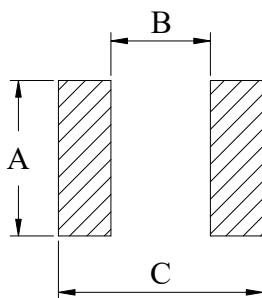

A	2.8
B	1.8
C	3.7

Unit : mm

### ■ Marking

The point on the top surface represents winding direction of choke.

Upside of Chip

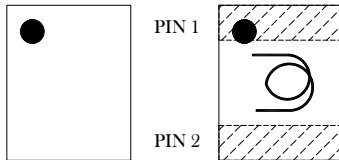

Coil clockwise around

### ■ Specifications

Part Number	L0 ◇ Inductance ( $\mu\text{H}$ ) @ (0A)	$R_{dc}$ ( $\text{m}\Omega$ ) ◇		Heat Rating Current DC Amps. $I_{dc}$ (A)		Saturation Current DC Amps. $I_{sat}$ (A)		Rated Voltage (V)
		Typical	Maximum	Typical	Maximum	Typical	Maximum	Maximum
VCTA32251B-R15MS6	0.15	10.0	12.0	6.8	6.0	11.6	10.0	20
VCTA32251B-R22MS6	0.22	11.0	13.0	6.5	5.8	11.6	10.0	20
VCTA32251B-R33MS6	0.33	13.0	16.0	5.8	5.3	9.5	8.6	20
VCTA32251B-R47MS6	0.47	18.0	22.0	5.1	4.6	8.2	7.0	20
VCTA32251B-R68MS6	0.68	25.0	30.0	4.4	3.9	6.5	5.6	20
VCTA32251B-1R0MS6	1.0	30.0	36.0	3.9	3.6	5.2	4.5	20
VCTA32251B-1R5MS6	1.5	45.0	54.0	3.4	3.1	4.3	3.7	20
VCTA32251B-2R2MS6	2.2	62.0	75.0	2.8	2.5	3.8	3.3	20
VCTA32251B-3R3MS6	3.3	105.0	127.0	2.2	2.0	2.9	2.5	20
VCTA32251B-4R7MS6	4.7	150.0	180.0	1.8	1.6	2.5	2.2	20
VCTA32251B-6R8MS6	6.8	250.0	300.0	1.5	1.3	2.3	2.0	20
VCTA32251B-100MS6	10.0	340.0	400.0	1.1	1.0	1.6	1.3	20
VCTA32251B-150MS6	15.0	670.0	804.0	0.8	0.7	1.2	1.0	20

◇ : Significant Characteristic

Note 1. : Inductance tolerance  $\pm 20\%$

Note 2. : All test data is referenced to 25°C ambient.

Note 3. : Test condition; 1MHz, 1.0Vrms

Note 4. :  $I_{dc}$  : DC current (A) that will cause an approximate  $\Delta T$  of 40°C

Note 5. :  $I_{sat}$  : DC current (A) that will cause L0 to drop approximately 30%

Note 6. : Operating temperature range -55°C to +165°C

Note 7. : The part temperature (ambient + temp rise) should not exceed 165°C under the worst case operating conditions. Circuit design, component placement, PCB trace size and thickness, airflow and other cooling provision all affect the part temperature. Part temperature should be verified in the end application.

Note 8. : The rated current as listed is either the saturation current or the heating current depending on which value is lower.

Note 9. : Cleaning process note

(a) If this power choke is dipped in the cleaning agent, such as toluene, xylene, ketone, and ether system, there is a possibility that the performance decreases greatly.

(b) The high power ultrasonic washing may damage the choke body.

(c) Please contact us if you need the cleaning via the above agents or ultrasonic washing.

Note 10. : If you require another part number, please contact with us.

### Current Characteristic

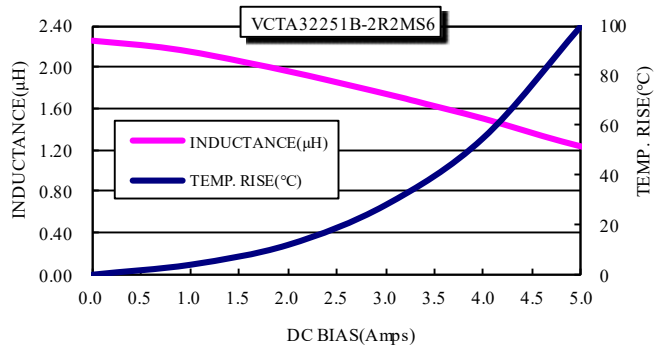
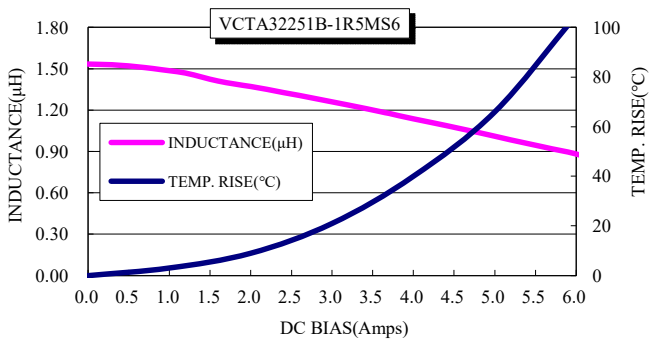
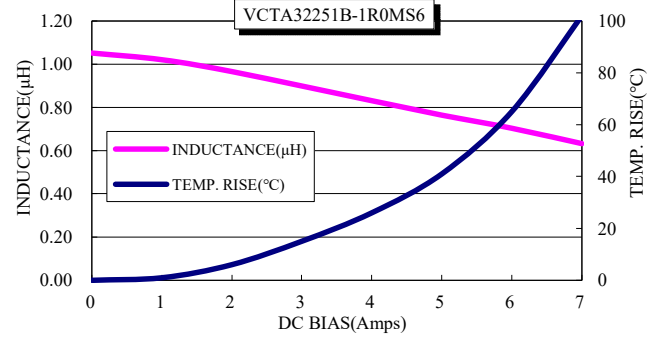
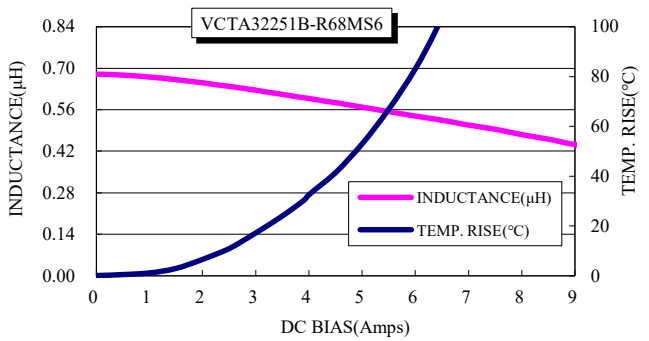
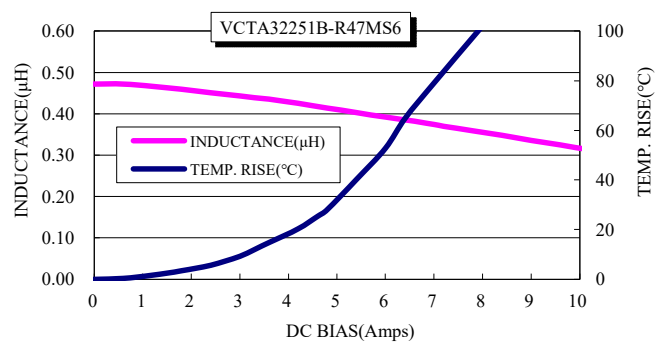
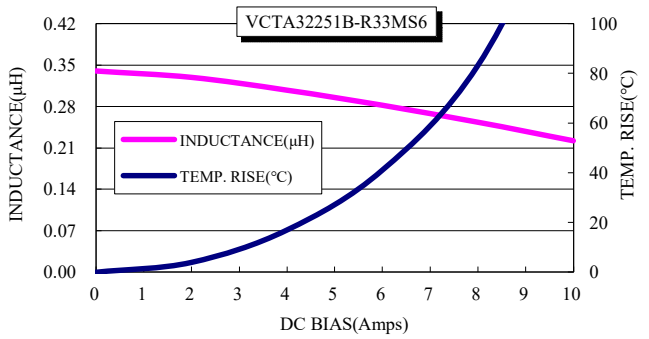
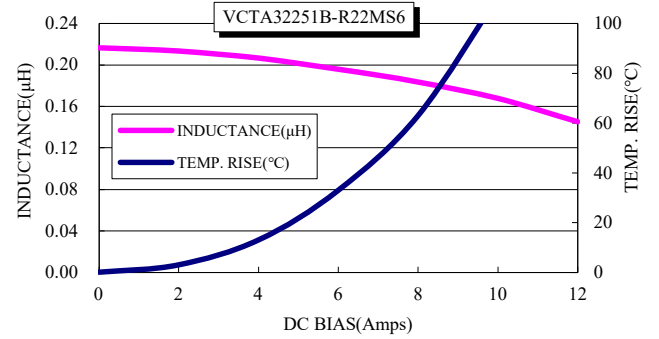
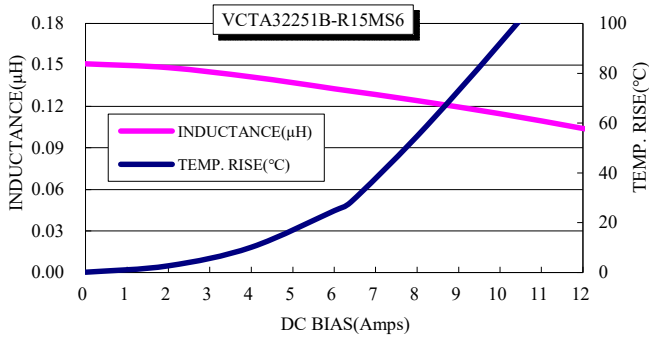

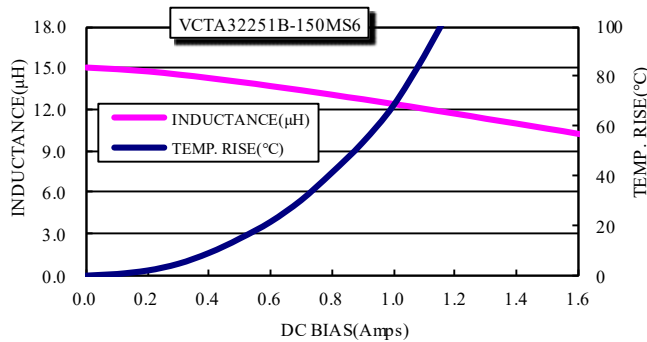
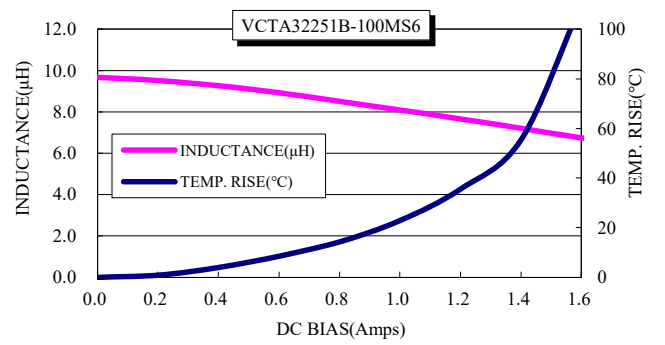
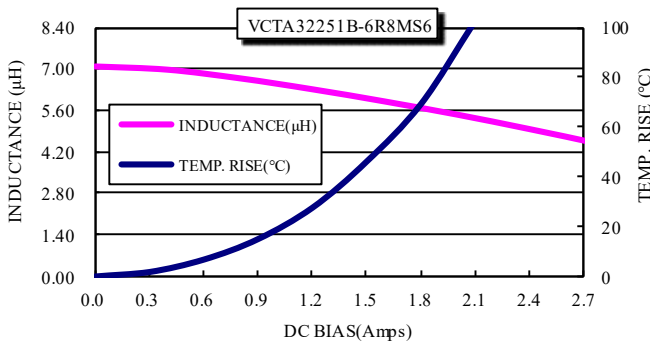
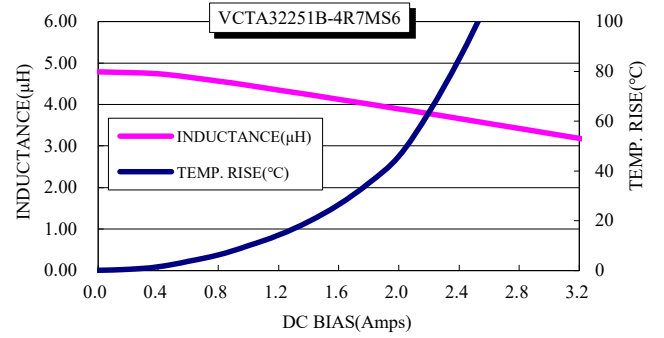
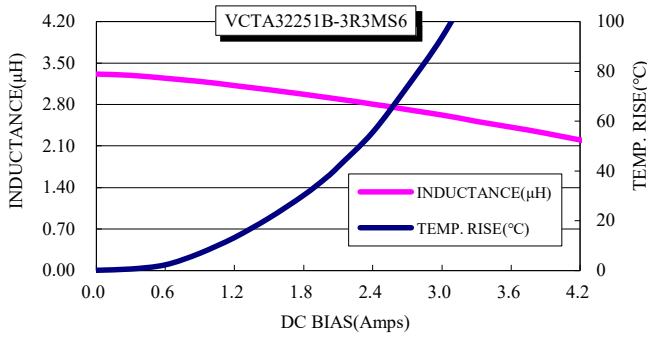

**■ Packaging**

(1) Tape packaging dimensions

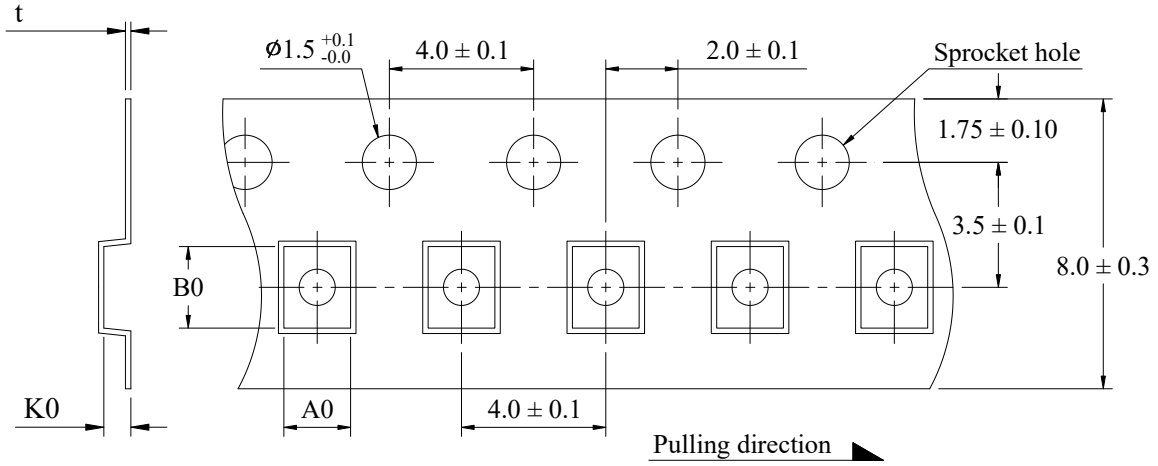

Dimensions Code (mm)				Units/Reel
A0	B0	K0	t	
$2.9 \pm 0.1$	$3.5 \pm 0.1$	$1.35 \pm 0.10$	$0.25 \pm 0.05$	2,000

(2) Tape direction

The direction shall be seen from the top cover tape side.

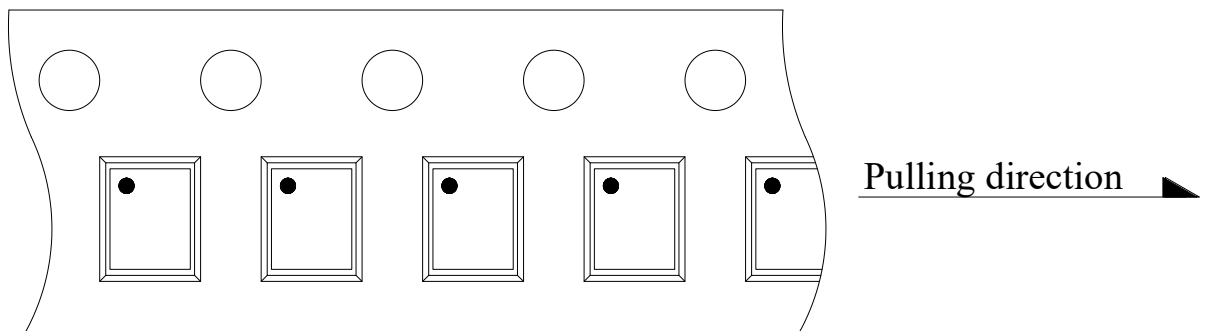

(3) Reel dimensions

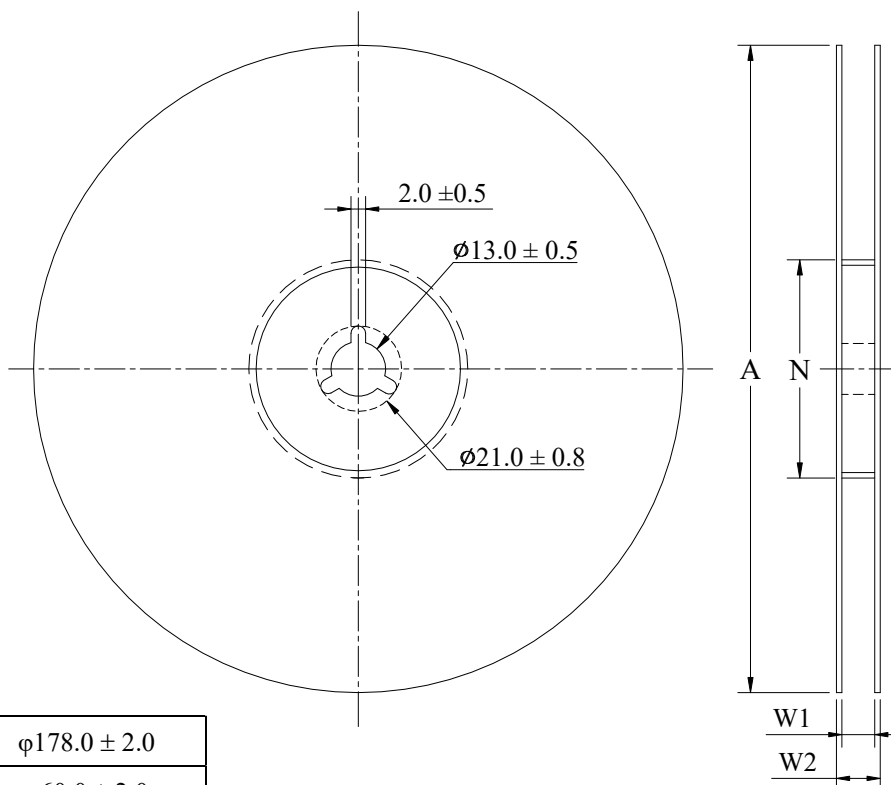

A	$\phi 178.0 \pm 2.0$
N	$\phi 60.0 \pm 2.0$
W1	$9.0 \pm 0.3$
W2	$11.4 \pm 1.0$

Unit : mm

(4) Peel force of top cover tape

The peel speed shall be about 300 mm/minute.

The peel force of top cover tape shall be between 0.1 to 0.7N.

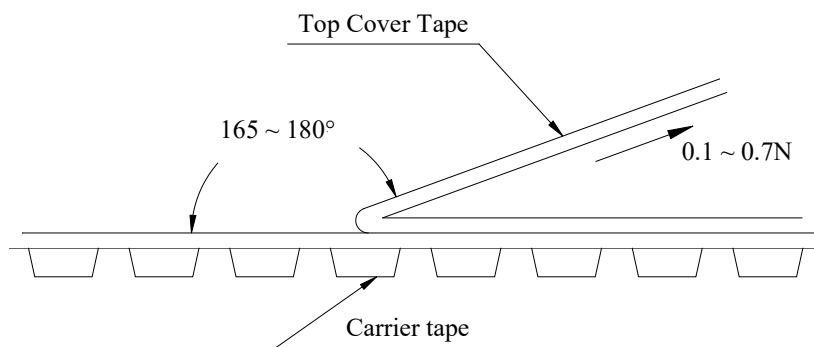

■ Reflow Profile

Power Choke Coil Type

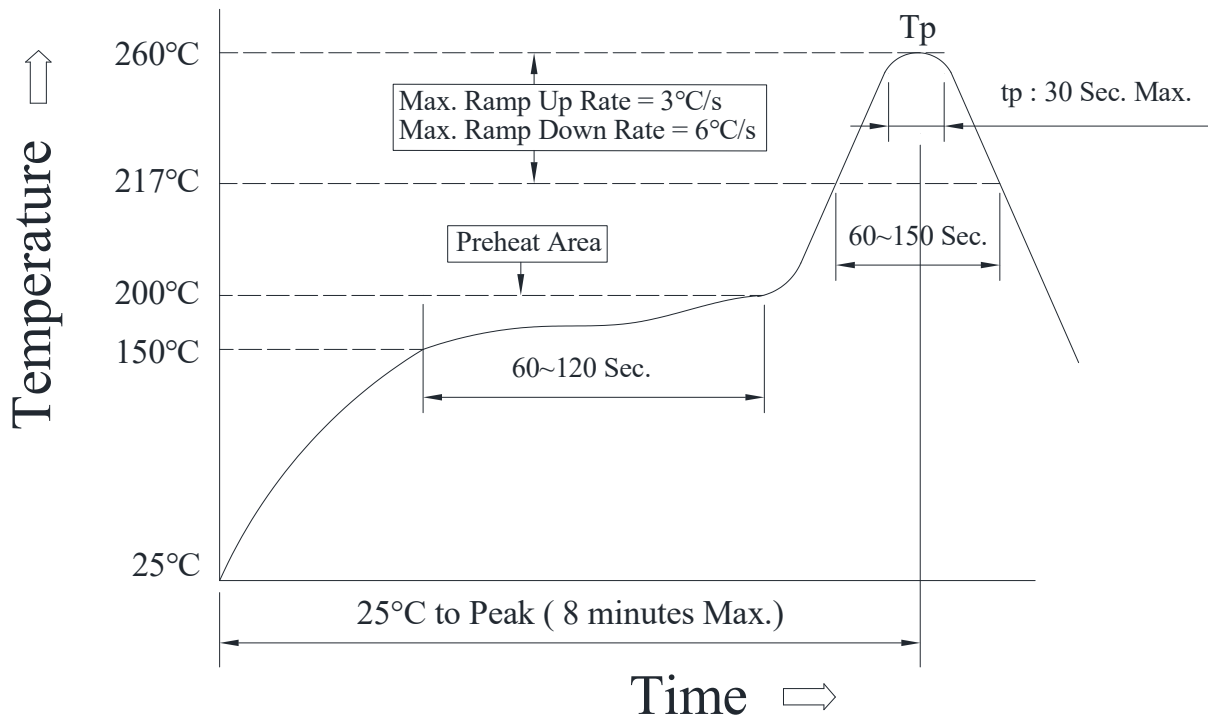

(1) Reflow soldering method :

Reflow Soldering	Tp : 255~260°C	Max. 30 seconds ( tp )
	≥ 217°C	60~150 seconds
Preheat	150~200°C	60~120 seconds
Time 25°C to peak temperature	8 minutes Max.	

(2) Soldering iron method : 350 ± 5°C, 3 seconds Max.

# Mouser Electronics

Authorized Distributor

Click to View Pricing, Inventory, Delivery & Lifecycle Information:

[Cyntec:](#)

[VCTA32251B-3R3MS6](#) [VCTA32251B-4R7MS6](#) [VCTA32251B-100MS6](#) [VCTA32251B-6R8MS6](#) [VCTA32251B-1R0MS6](#) [VCTA32251B-150MS6](#) [VCTA32251B-1R5MS6](#) [VCTA32251B-R47MS6](#) [VCTA32251B-R68MS6](#) [VCTA32251B-R33MS6](#) [VCTA32251B-2R2MS6](#)