

# D10 Expert™ Series with Bar Graph Display and Discrete Output

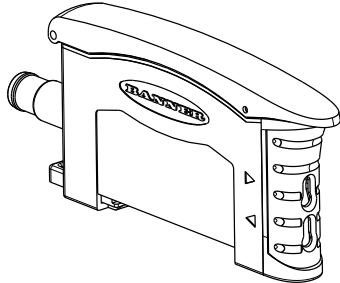

## Datasheet

Advanced sensor with dual displays for use with plastic fiber optics



- Easy-to-read 8-segment light bar indicator for teach and signal strength readout, plus indicators for continuous readout of operating status (user configuration)
- Easy-to-set automatic Expert-style configuration options include Static and Dynamic TEACH, and Window SET, plus manual adjustment for fine tuning
- Smart gain-control algorithm to maximize performance in low-contrast applications
- Fast 500-microsecond sensing response with improved crosstalk avoidance routine (for two sensors) in Normal mode
- Selectable high-speed (HS) mode option for 200- $\mu$ s response
- Extreme configuration flexibility via push buttons or a remote input wire
- Easy selection of Light/Dark Operate (LO/DO), 30 ms pulse stretcher (OFFdelay), and response speed, via push buttons or a remote input wire
- Models available with visible red (680 nm) or visible green (525 nm) sensing beam
- Sleek, ultra-slim 10 mm housing, mounts to a standard 35 mm DIN rail
- Models with bussable power provide simplified wiring of up to 16 sensors and feature improved temperature compensation for side-by-side mounting



### WARNING:

- **Do not use this device for personnel protection**
- Using this device for personnel protection could result in serious injury or death.
- This device does not include the self-checking redundant circuitry necessary to allow its use in personnel safety applications. A device failure or malfunction can cause either an energized (on) or de-energized (off) output condition.

## Models

Red Beam Models	Green Beam Models	Description	Cable <sup>1</sup>	Outputs
D10BFP	D10BFPG	Standard sensor	2 m (6.5 ft) Cable	Bipolar NPN/PNP
D10BFPQ	D10BFPGQ		6-pin M8 QD	
<b>Models with Bussable Power</b>				
D10B5FP	-	Main unit	2 m (6.5 ft) Cable	Bipolar NPN/PNP
D10B2PPF	-	Sub-unit	2 m (6.5 ft) Cable	Single PNP
D10B2NFP	-		2 m (6.5 ft) Cable	Single NPN

## Overview

The D10 Expert™ is an easy-to-use, DIN-rail-mountable fiber optic sensor. It provides high-performance sensing in low-contrast applications. Configuration options include Setup mode plus Static and Dynamic TEACH, and Window Set options, in addition to manual fine adjustment, remote programming, and security push button lockout.

The sensor's compact housing has a large, easy-to-see bar graph display plus bright LEDs for easy programming and status monitoring during operation.

Standard models have bipolar outputs, one each NPN and PNP. Main units with bussable power have the same bipolar outputs; sub-units feature a single discrete output, either NPN or PNP.

Models with bussable power are designed for use in machines and other applications where multiple sensors will be grouped tightly. They feature increased temperature compensation compared with standard models and reduce the amount of wiring necessary for such applications. An accessory clamp is available to secure a bank of connected sensors together on a DIN rail (see [Accessories](#) on p. 10).

Figure 1. Features

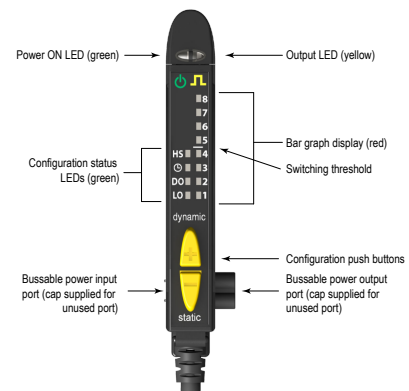

<sup>1</sup> To order the 9 m (30 ft) PVC cable model, add the suffix "W/30" to the cabled model number. For example, D10xFP W/30. Models with a quick disconnect require a mating cordset. See Accessories.



## Sensor Configuration

Sensor configuration is accomplished via TEACH, Set, and Setup modes. After the sensing parameters are defined (using either TEACH or Set mode), Setup mode may be used to enable the delay, to change the light/dark operate status, or to select the highspeed response option (HS). Manual Adjust may be used to fine-tune the thresholds. Two push buttons, Dynamic (+) and Static (-), or the remote wire, may be used to access and set the sensing parameters.

Sensor sensitivity may be configured using any of three methods. A single switching threshold may be achieved using either Dynamic (on-the-fly) or Static TEACH; or Window SET may be used to define a sensing window, centered on a single sensing condition.

### Remote Configuration

The remote configuration function may be used to configure the sensor remotely or to disable the push buttons for security. Connect the gray wire of the sensor to ground (0V dc), with a remote programming switch connected between them. Pulse the remote line according to the diagrams in the configuration procedures. The duration of the individual pulses is equal to the value T: **0.04 seconds ≤ T ≤ 0.8 seconds**

### Returning to RUN Mode

Some TEACH, Set, and Setup modes may be exited either after the 60-second timeout, or by exiting the process:

- In Static TEACH or Window Set mode, press and hold the Static (-) button (or hold the remote line) for 2 seconds. The sensor returns to Run mode without saving any new settings.
- In Setup mode, press and hold both the Static (-) and Dynamic (+) buttons (or hold the remote line) for 2 seconds. The sensor returns to Run mode and saves the current setting.

### Two-Point Static TEACH (Threshold)

- Establishes a single switching threshold
- Threshold position is adjustable using “+” and “-” buttons (see [Manual Adjust](#) on p. 7)

Static TEACH is the traditional set-up method, used when two conditions can be presented by the user. The sensor locates a single sensing threshold (the switchpoint) midway between the two taught conditions, with the Output ON condition on one side, and the Output OFF condition on the other.

The first condition taught is the ON condition. The Output ON and OFF conditions can be reversed by changing Light/Dark Operate status in Setup mode (see [Setup Mode](#) on p. 6).

#### Static TEACH and Manual Adjust

Using Manual Adjust with Static TEACH moves the switching threshold. The lighted LED on the bar graph will move to exhibit the received signal, relative to the switchpoint.

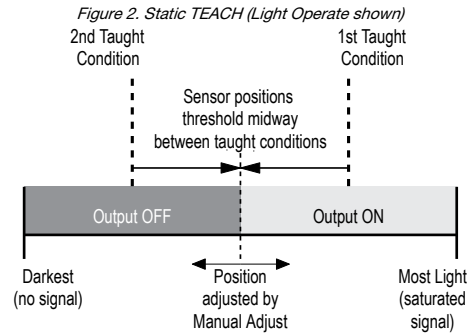

Bar Graph LED Following TEACH	Relative Signal Difference / Recommendation
6 to 8	Excellent: Very stable operation
4 to 5	Good: Minor sensing variables may affect sensing reliability
2 to 3	Low: Minor sensing variables may affect sensing reliability
1	Unreliable: Consider an alternate sensing scheme

The duration of each button click or remote input pulse is defined as T, where T is: 0.04 s < T < 0.8 s.

1. Access the TEACH Mode.

Method	Action	Result
<b>Push Button</b>	Press and hold the Static button > 2 seconds.	<ul style="list-style-type: none"> <li>• Power LED: OFF</li> <li>• Output LED: ON</li> <li>• Status LEDs: LO &amp; DO alternately flash</li> <li>• Bar graph: OFF</li> </ul>
<b>Remote Input</b>	No action is required; the sensor is ready for 1st TEACH condition.	

2. TEACH the Output ON condition.

Method	Action	Result
<b>Push Button</b>	a. Present the Output ON condition. b. Click the Static button.	<ul style="list-style-type: none"> <li>• Power LED: OFF</li> <li>• Output LED: Flash, then OFF</li> <li>• Status LEDs: LO &amp; DO alternately flash</li> <li>• Bar graph: OFF</li> </ul>
<b>Remote Input</b>	a. Present the Output ON condition. b. Single-pulse the remote line.	

3. TEACH the Output OFF condition.

Method	Action	Result
<b>Push Button</b>	a. Present the Output OFF condition. b. Click the Static button.	
<b>Remote Input</b>	a. Present the Output OFF condition. b. Single-pulse the remote line.	

**TEACH Accepted**

- Power LED: ON
- Bar graph: One LED flashes to show relative contrast (good signal difference shown; see table above)

Sensor returns to Run mode.

**TEACH Unacceptable**

- Power LED: OFF
- Bar graph: #1, 3, 5, 7 alternately flash to show failure

Sensor returns to the "TEACH Output ON condition".

### Dynamic TEACH and Adaptive Thresholds

- Teach on-the-fly
- Establishes a single switching threshold
- Threshold position is adjustable using "+" and "-" buttons (Manual Adjust)

Dynamic TEACH is best used when a machine or process may not be stopped for teaching. It programs the sensor during actual sensing conditions, taking multiple samples of the light and dark conditions and automatically setting the threshold at the optimum level.

Dynamic TEACH activates the sensor's adaptive threshold system, which continuously tracks minimum and maximum signal levels, and automatically maintains centering of the switchpoint between the light and dark conditions. The adaptive threshold system remains in effect during Run mode. The adaptive routine saves to non-volatile memory at least once per hour.

When Dynamic TEACH mode is used, the output ON state (Light or Dark Operate) remains as it was last programmed. To change the output ON state, use Setup mode.

**Dynamic TEACH and Manual Adjust**— The switchpoint may be adjusted (fine-tuned) whenever the sensor is in Run mode by clicking the "+" and "-" buttons. However, when a manual adjustment is made, the adaptive threshold system is disabled (cancelled).

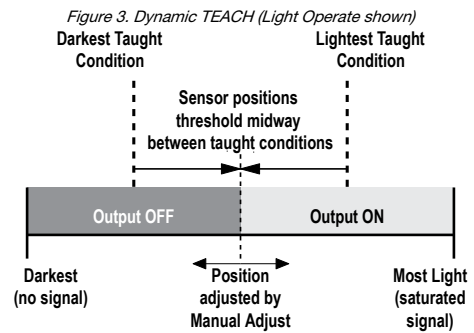

Bar Graph LED Following TEACH	Relative Signal Difference / Recommendation
6 to 8	Excellent: Very stable operation
4 to 5	Good: Minor sensing variables may affect sensing reliability
2 to 3	Low: Minor sensing variables may affect sensing reliability
1	Unreliable: Consider an alternate sensing scheme

The duration of each button click or remote input pulse is defined as T, where T is: 0.04 s < T < 0.8 s.

1. Access the Dynamic TEACH Mode.

Method	Action	Result
<b>Push Button</b>	Press and hold the Dynamic push button > 2 seconds.	
<b>Remote Input</b>	Hold the remote line low (to ground) > 2 seconds.	

- Power LED: OFF
- Output LED: OFF
- Bar graph: LO & DO alternately flash

2. TEACH the sensing condition.

Method	Action	Result
<b>Push Button</b>	Continue to hold push button and present Output ON and OFF conditions.	
<b>Remote Input</b>	Continue to hold remote line low (to ground) and present Output ON and OFF conditions.	

- Power LED: OFF
- Output LED: OFF
- Bar graph: LO & DO alternately flash

3. Return to RUN Mode.

Method	Action	Result
Push Button	Release the push button.	
Remote Input	Release the remote line/switch	

**TEACH Accepted**

- Power LED: ON
- Bar graph: One LED flashes to show relative contrast (good signal difference shown; see table above)

Sensor returns to Run mode with new settings.

**TEACH Not Accepted**

- Power LED: OFF
- Bar graph: #1, 3, 5, 7 alternately flash to show failure

Sensor returns to Run mode without changing settings

### Single-Point Window Set

- Sets a single ON condition that extends 12.5% above and below the taught condition
- All other conditions (lighter or darker) result in OFF output
- Sensing window size (sensitivity) is adjustable using “+” and “-” buttons (see [Manual Adjust](#) on p. 7)

Window Set is most useful when a product may not always appear in the same place, or when other signals may appear. Window Set designates a sensing window, with the Output ON condition inside the window, and the Output OFF conditions outside the window. The sensor accepts a single sensing condition, and adds switching thresholds above and below that condition to create a sensing window. Output ON and OFF conditions can be reversed by changing Light/Dark Operate status in Setup mode.

**Window Set and Manual Adjust**—Using Manual Adjust with Window Set expands or contracts the size of the window. The lighted LEDs on the light bar separate to a greater or lesser extent to exhibit the relative sensing window size.

Figure 4. Single-Point Window SET (Light Operate shown)

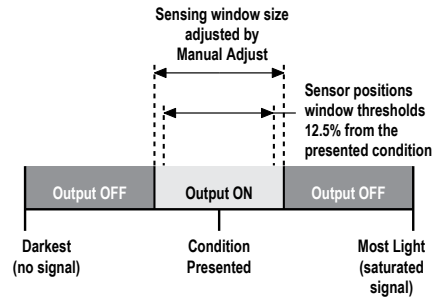

The duration of each button click or remote input pulse is defined as T, where T is: 0.04 s < T < 0.8 s.

1. Access the SET Mode.

Method	Action	Result
Push Button	Press and hold the Static button > 2 seconds.	
Remote Input	Single-pulse the remote line.	

• Power LED: OFF

• Output LED: ON (Push Button)

• Output LED: OFF (Remote)

• Status LEDs: LO & DO flash alternately

2. SET the sensing condition.

Method	Action	Result
Push Button	a. Present the sensing condition. b. Double-click the Static button.	
Remote Input	a. Present sensing the condition. b. Double-pulse the remote line.	

**Window Accepted**

- Power LED: ON
- Bar graph: 2 indicators flash together to show Window accepted

Sensor returns to Run mode with the new settings.

**Window Not Accepted**

- Power LED: OFF
- Bar graph: #1, 3, 5, 7 flash to show failure

Sensor returns to the "SET Sensing condition".

### Single-Point Light Set

- Sets a threshold 6.25% below the taught condition.
- Any condition darker than the threshold condition causes the output to change state
- Threshold position is adjustable using the “+” and “-” buttons (see [Manual Adjust](#) on p. 7)
- Recommended for applications where only one condition is known, for example a stable light background with varying darker targets

A single sensing condition is presented, and the sensor positions a threshold 6.25% below the presented condition. When a condition darker than the threshold is sensed, the output either turns ON or OFF, depending on the Light/Dark Operate setting (see [Setup Mode](#) on p. 6).

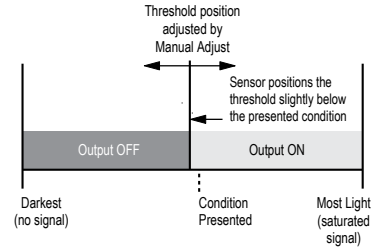

**Light SET and Light/Dark Operate Selection**— In Light Operate mode, Light Set teaches the Output ON condition. In Dark Operate mode, Light Set teaches the Output OFF condition.

Figure 5. Single-Point Light Set (Light Operate shown)





The duration of each button click or remote input pulse is defined as T, where T is:  $0.04\text{ s} < T < 0.8\text{ s}$ .

1. Access the SET Mode.

Method	Action	Result
<b>Push Button</b>	Press and hold the Static button > 2 seconds. 	<ul style="list-style-type: none"> <li>• Power LED: OFF</li> <li>• Output LED: ON (push button)</li> <li>• OFF (remote line)</li> <li>• Static LEDs: LO &amp; DO alternately flash</li> </ul>
<b>Remote Input</b>	Single-pulse the remote line. 	

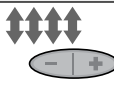
2. SET the sensing condition.

Method	Action	Result
<b>Push Button</b>	a. Present the sensing condition. b. Four-click the Static push button. 	<p><b>Threshold condition accepted</b></p> <ul style="list-style-type: none"> <li>• Power LED: ON</li> <li>• Output LED: ON (push button)</li> <li>• OFF (remote line)</li> <li>• Bar graph: 4 indicators flash together</li> </ul> <p>Sensor returns to Run mode with the new settings.</p> <p><b>Threshold condition not accepted</b></p> <ul style="list-style-type: none"> <li>• Power LED: ON</li> <li>• Output LED: ON (push button)</li> <li>• OFF (remote line)</li> <li>• Bar graph: #1, 3, 5, 7 alternately flash to show failure</li> </ul> <p>Sensor returns to the "SET Sensing Condition".</p>
<b>Remote Input</b>	a. Present the sensing condition. b. Four-pulse the remote line. 	

### Single-Point Dark Set

- Sets a threshold 6.25% above the taught condition
- Any condition lighter than the threshold condition causes the output to change state
- Threshold position is adjustable using the "+" and "-" buttons (see [Manual Adjust](#) on p. 7)
- Recommended for applications where only one condition is known, for example a stable dark background with varying lighter targets

A single sensing condition is presented, and the sensor positions a threshold 6.25% above the taught condition. When a condition lighter than the threshold is sensed, the output either turns ON or OFF, depending on the Light/Dark Operate setting (see [Setup Mode](#) on p. 6).

**Dark Set and Light/Dark Operate Selection**— In Light Operate mode, Dark Set teaches the Output OFF condition. In Dark Operate mode, Dark Set teaches the Output ON condition.

Figure 6. Single-Point Dark Set (Light Operate shown)

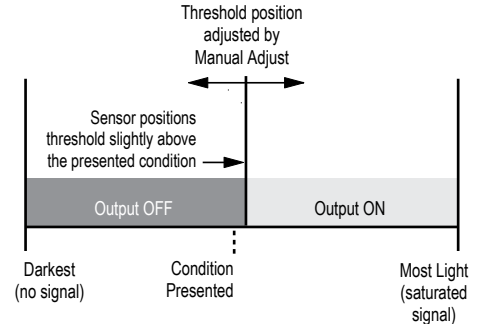

The duration of each button click or remote input pulse is defined as T, where T is:  $0.04\text{ s} < T < 0.8\text{ s}$ .

1. Access Set Mode

Method	Action	Result
<b>Push Button</b>	Press and hold the Static button > 2 seconds. 	<ul style="list-style-type: none"> <li>• Power LED: OFF</li> <li>• Output LED: ON (push button)</li> <li>• OFF (remote line)</li> <li>• Static LEDs: LO &amp; DO alternately flash</li> </ul>

Method	Action	Result
Remote Input	Single-pulse the remote line.	

2. Set the sensing condition.

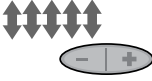
Method	Action	Result
Push Button	a. Present the sensing condition. b. Five-click the Static button.	
Remote Input	a. Present the sensing condition. b. Five-pulse the remote line.	
		<p><b>Threshold Condition Accepted</b></p> <ul style="list-style-type: none"> <li>Power LED: ON</li> <li>Output LED: ON (push button)</li> <li>OFF (remote line)</li> <li>Bar graph: 4 indicators flash together</li> </ul> <p>The sensor returns to Run mode with the new settings.</p> <p><b>Threshold Condition Not Accepted</b></p> <ul style="list-style-type: none"> <li>Power LED: ON</li> <li>Output LED: ON (push button)</li> <li>OFF (remote line)</li> <li>Bar graph: #1, 3, 5, 7 flash to show failure</li> </ul> <p>The sensor returns to the "SET Sensing Condition".</p>

### Setup Mode

Use Setup mode to change sensor output response for:

- Light or Dark operate
- 30-millisecond pulse stretcher (OFF-delay), if required
- 200 µs high-speed response

If Setup mode configuration is interrupted and remains inactive for 60 seconds, the sensor returns to Run mode with the most recent settings (i.e., exits and saves current selection).

Setup mode operates in the background, while the outputs are active; changes are updated instantly.

The duration of each button click or remote input pulse is defined as T, where T is: 0.04 s < T < 0.8 s.

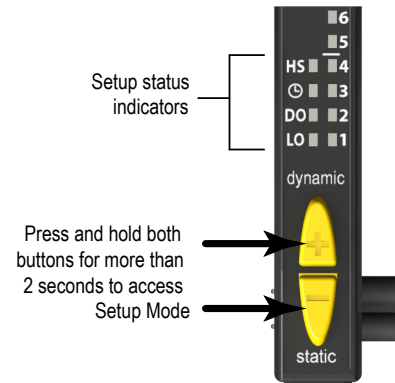

1. Access the Setup Mode.

Method	Action	Result
Push Button	Press and hold both push buttons > 2 seconds.	<ul style="list-style-type: none"> <li>Power LED: OFF</li> <li>Output LED: remains active</li> <li>Icon continue to display current setup</li> <li>Static LEDs: OFF</li> </ul>
Remote Input	Double-pulse the remote line.	

2. Select the setting combination.

Method	Action	Result
Push Button	Click either push button until the LEDs show desired settings.	<p>The sensor toggles through eight setting combinations, in the following order:</p> <ul style="list-style-type: none"> <li>LO - Normal Speed - No Delay (default)</li> <li>DO - Normal Speed - No Delay</li> <li>LO - High Speed - No Delay</li> <li>DO - High Speed - No Delay</li> <li>LO - Normal Speed - Delay</li> <li>DO - Normal Speed - Delay</li> <li>LO - High Speed - Delay</li> <li>DO - High Speed - Delay</li> </ul>
Remote Input	Pulse the remote line until the LEDs show desired settings.	

3. Return to Run Mode.

Method	Action		Result
Push Button	Press and hold both push buttons > 2 seconds.		Power LED: ON The sensor returns to RUN mode with the new settings.
Remote Input	Hold remote the line low > 2 seconds.		

### Manual Adjust

Manual Adjust is used during Run mode and is accomplished using the push buttons only. Its behavior depends on whether a switching threshold or a sensing window is used.

#### Switching Threshold:

- Fine-tunes sensing sensitivity
- Press “+” to increase; press “-” to decrease

#### Sensing Window:

- Adjusts sensing window size (tolerance) for the single-point target condition
- Press “+” to increase; press “-” to decrease

The lighted bar graph LEDs move to reflect the increase or decrease.

### Enabling or Disabling the Push Button

In addition to its programming function, the remote line may be used to disable the push buttons for security. Disabling the push buttons prevents undesired tampering with the sensor configuration settings.

1. Connect the sensor’s gray wire.
2. Four-pulse the remote line to enable or disable the push button.  
The sensor toggles between enable and disable settings and returns to RUN mode.

### Wiring Diagrams

Standard Models and Main Unit	Installing Fibers
<p>1 - Brown 2 - White 3 - Blue 4 - Black 5 - Gray (not used) 6 - Pink (not used)</p> <p>The QD hookup is functionally identical. The pink wire is not used.</p>	<p>Slides up to release fibers</p> <p>Plastic fiber emitter port</p> <p>Plastic fiber receiver port</p>
Sub-Units	
NPN	PNP
<p>12-30V dc Connection From Main Unit Bus</p>	<p>12-30V dc Connection From Main Unit Bus</p>

## Specifications

### Supply Voltage

Standard Sensors: 10 to 30 V DC (10% maximum ripple) at less than 45 mA exclusive of load  
 Models with bussable power: 12 to 30 V DC (10% maximum ripple) at less than 45 mA exclusive of load

### Supply Protection Circuitry

Protected against reverse polarity, over voltage, and transient voltage

### Delay at Power Up

Standard Sensors: 200 milliseconds maximum; outputs do not conduct during this time  
 Models with Bussable Power: 850 milliseconds maximum; outputs do not conduct during this time

### Sensing Beam

Standard sensors: 660 nm visible red or 525 nm visible green, depending on model  
 Models with bussable power: 660 nm visible red

### Output Rating (Standard Sensors)

Standard Sensors: 150 mA maximum load at 25° C (derate 1 mA per °C increase)  
 OFF-state leakage current: < 5 µA at 30 V DC  
 ON-state saturation voltage: **NPN:** < 1.5 V; **PNP:** < 2 V  
 at 10 mA; 1.5 V at 150 mA load

### Output Rating (Models with Bussable Power)

Models with Bussable Power: 100 mA maximum load (derate 1 mA per °C above 30 °C)  
 OFF-state leakage current: < 5 µA at 30 V DC  
 ON-state saturation voltage: **NPN:** < 1.5 V; **PNP:** < 2 V  
 Supply 15 V or more: up to 16 units with 100 mA outputs  
 Less than 15 V supply (9 m cable): up to 4 units with 100 mA outputs; up to 8 units with 50 mA outputs

### Required Overcurrent Protection



**WARNING:** Electrical connections must be made by qualified personnel in accordance with local and national electrical codes and regulations.

Overcurrent protection is required to be provided by end product application per the supplied table.  
 Overcurrent protection may be provided with external fusing or via Current Limiting, Class 2 Power Supply.  
 Supply wiring leads < 24 AWG shall not be spliced.  
 For additional product support, go to [www.bannerengineering.com](http://www.bannerengineering.com).

Supply Wiring (AWG)	Required Overcurrent Protection (Amps)
20	5.0
22	3.0
24	2.0
26	1.0
28	0.8
30	0.5

### Output Protection

Protected against output short-circuit, continuous overload, transient over-voltages, and false pulse on power-up

### Output Response Time

500 microseconds (normal mode) or 200 microseconds (high-speed mode)

### Repeatability

100 microseconds (normal mode) or 66 microseconds (high-speed mode)

### Construction

Black ABS/polycarbonate alloy (UL94 V-0 rated) housing, clear polycarbonate cover

### Adjustments

Two push buttons and remote wire

- Expert-style configuration (Static and Dynamic TEACH, and Window Set)
- Manually adjust (+/-) sensitivity (from push buttons only)
- LO/DO, OFF-delay, and response speed configurable (from push buttons or remote wire)
- Push button lockout (from remote wire only)

### Factory Default Settings:

Light Operate, Normal Speed, No Delay  
 Push-button or remote programming of response time, OFF-delay, light/dark operate, and display

### Indicators

Eight-segment red bar graph: Light-to-dark signal difference relative to taught condition (Window Set); Sensing contrast (Static or Dynamic TEACH)  
 Green Status Indicators: LO, DO, High Speed (HS), and OFF-Delay  
 Green LED: Power ON  
 Yellow LED: Output conducting

### Environmental Rating

IP50, NEMA 1

### Connections

Standard Sensors: PVC-jacketed 2 m or 9 m (6.5 ft or 30 ft) 6-wire integral cable or integral 6-pin M8 quick-disconnect  
 Models with Bussable Power: **Main units:** PVC-jacketed 2 m or 9 m (6.5 ft or 30 ft) 5-wire integral cable; **Sub-units:** PVC-jacketed 2 m or 9 m (6.5 ft or 30 ft) 2-wire integral cable

### Operating Conditions

**Temperature:** -10 °C to +55 °C (+14 °F to +131 °F)  
**Storage Temperature:** -20 °C to +85 °C (-4 °F to +185 °F)  
 90% at +55 °C maximum relative humidity (non-condensing)

### Certifications



## Dimensions

All measurements are listed in millimeters [inches], unless noted otherwise.

Figure 7. D10 dimensions

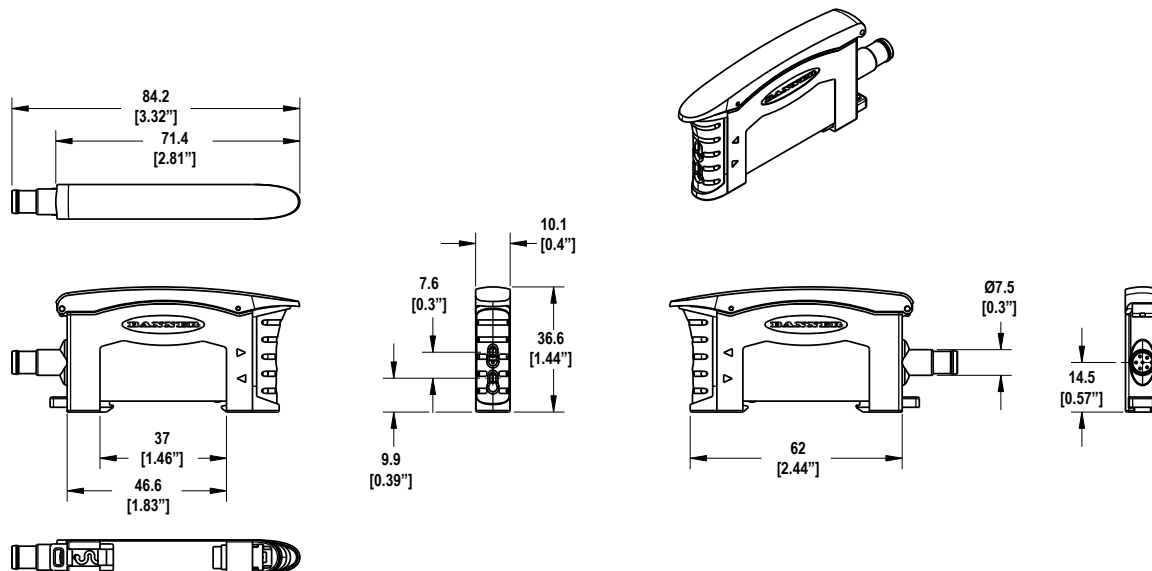
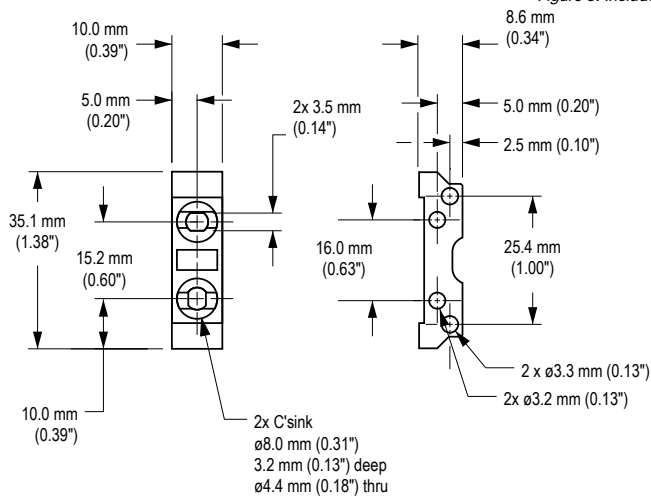

Figure 8. Included bracket dimensions



- M3 Hardware included:  
 Lock Washer (2)  
 Flat Washer (2)  
 Screws (2)  
 Hex Nuts (2)

## Performance Curves

### Red Beam Models

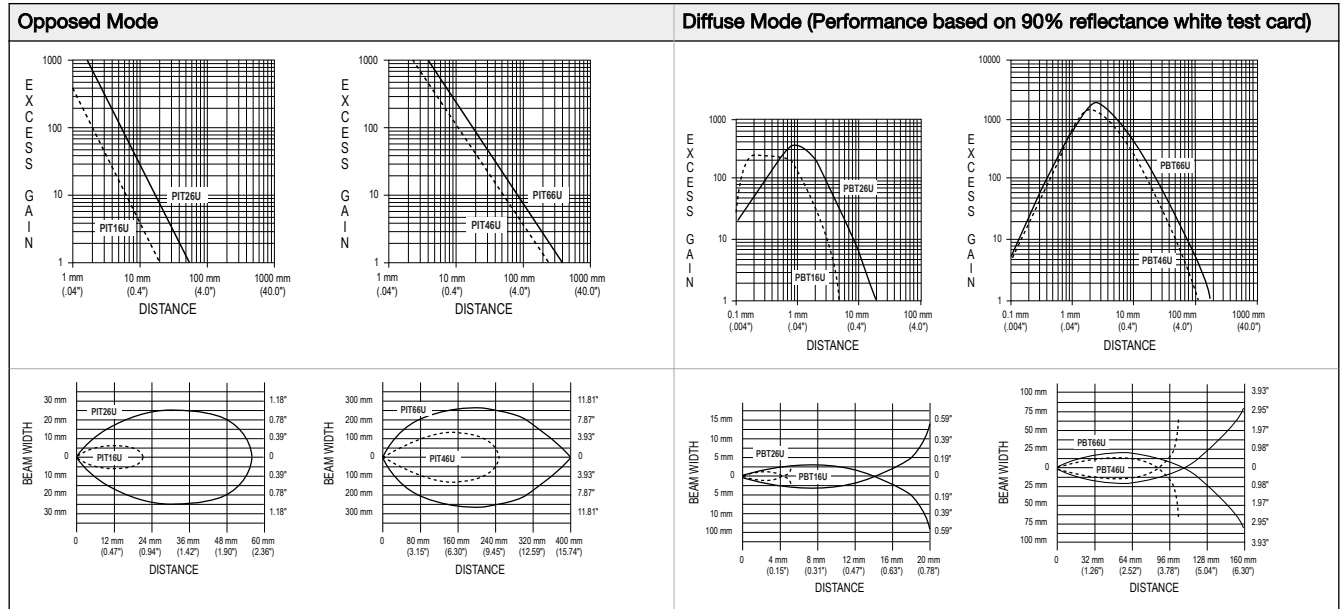

### Green Beam Models

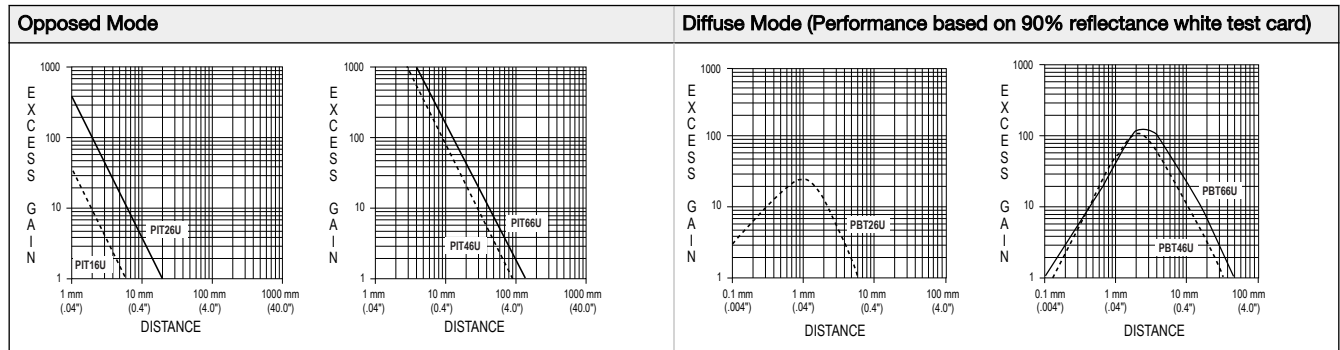

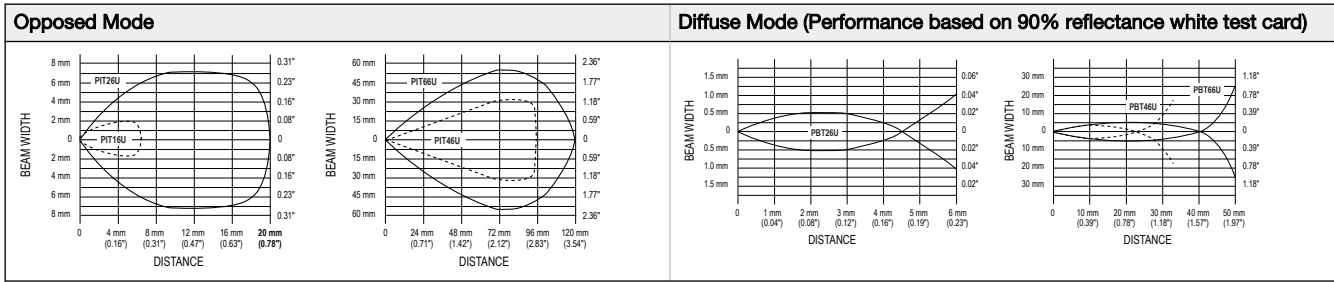

## Accessories

### Quick Disconnect Cordsets

6-Pin Snap-on M8 Cordsets—Single Ended				
Model	Length	Style	Dimensions	Pinout (Female)
PKG6Z-2	2 m (6.56 ft)	Straight		<p>1 - brown 2 = White 3 = Blue 4 = Black 5 = Gray 6 = Pink</p>
PKG6Z-9	9 m (29.53 ft)			
PKW6Z-2	2 m (6.56 ft)	Right-angle		
PKW6Z-9	9 m (29.53 ft)			

### DIN Rail Accessories

#### SA-DIN-CLAMP

- Pair of metal DIN rail end stops; slide onto DIN rail at either side of the sensor stack
- Combination (#2 Phillips, #8 standard slotted) set screw

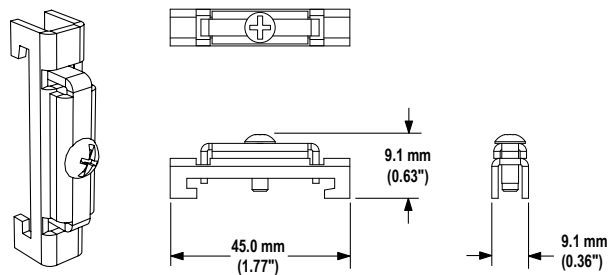

#### SA-D10B-CAP

Package of 5 each replacement terminal caps and plugs to cover beginning and end of stack of connected sensors.

## Banner Engineering Corp. Limited Warranty

---

Banner Engineering Corp. warrants its products to be free from defects in material and workmanship for one year following the date of shipment. Banner Engineering Corp. will repair or replace, free of charge, any product of its manufacture which, at the time it is returned to the factory, is found to have been defective during the warranty period. This warranty does not cover damage or liability for misuse, abuse, or the improper application or installation of the Banner product.

**THIS LIMITED WARRANTY IS EXCLUSIVE AND IN LIEU OF ALL OTHER WARRANTIES WHETHER EXPRESS OR IMPLIED (INCLUDING, WITHOUT LIMITATION, ANY WARRANTY OF MERCHANTABILITY OR FITNESS FOR A PARTICULAR PURPOSE), AND WHETHER ARISING UNDER COURSE OF PERFORMANCE, COURSE OF DEALING OR TRADE USAGE.**

This Warranty is exclusive and limited to repair or, at the discretion of Banner Engineering Corp., replacement. **IN NO EVENT SHALL BANNER ENGINEERING CORP. BE LIABLE TO BUYER OR ANY OTHER PERSON OR ENTITY FOR ANY EXTRA COSTS, EXPENSES, LOSSES, LOSS OF PROFITS, OR ANY INCIDENTAL, CONSEQUENTIAL OR SPECIAL DAMAGES RESULTING FROM ANY PRODUCT DEFECT OR FROM THE USE OR INABILITY TO USE THE PRODUCT, WHETHER ARISING IN CONTRACT OR WARRANTY, STATUTE, TORT, STRICT LIABILITY, NEGLIGENCE, OR OTHERWISE.**

Banner Engineering Corp. reserves the right to change, modify or improve the design of the product without assuming any obligations or liabilities relating to any product previously manufactured by Banner Engineering Corp. Any misuse, abuse, or improper application or installation of this product or use of the product for personal protection applications when the product is identified as not intended for such purposes will void the product warranty. Any modifications to this product without prior express approval by Banner Engineering Corp will void the product warranties. All specifications published in this document are subject to change; Banner reserves the right to modify product specifications or update documentation at any time. Specifications and product information in English supersede that which is provided in any other language. For the most recent version of any documentation, refer to: [www.bannerengineering.com](http://www.bannerengineering.com).

For patent information, see [www.bannerengineering.com/patents](http://www.bannerengineering.com/patents).

# Mouser Electronics

Authorized Distributor

Click to View Pricing, Inventory, Delivery & Lifecycle Information:

[Banner Engineering:](#)

[D10BFP](#) [D10BFPQ](#) [D10BFPG](#) [D10BFPGQ](#)