

AMY-35-S

~18° spot beam

SPECIFICATION:

Dimensions	Ø 35.0
Height	8.5 mm
Fastening	socket
ROHS compliant	yes ⓘ

MATERIALS:

Component	Type	Material	Colour	Finish	Length (mm)
AMY-35-S	Single lens	PMMA	clear		
AMY-35-HLD2-B	Holder B	PC	black		
AMY-35-HLD2-B-WHT	Holder B	PC	white		



ORDERING INFORMATION:

Component	Qty in box	MOQ	MPQ	Box weight (kg)
C17794_AMY-35-S	1650	132	66	9.7
Assembly				
CP19167_AMY-35-S-B2-WHT	1320	132	66	9.6
CP19161_AMY-35-S-B2	1320	132	66	9.6

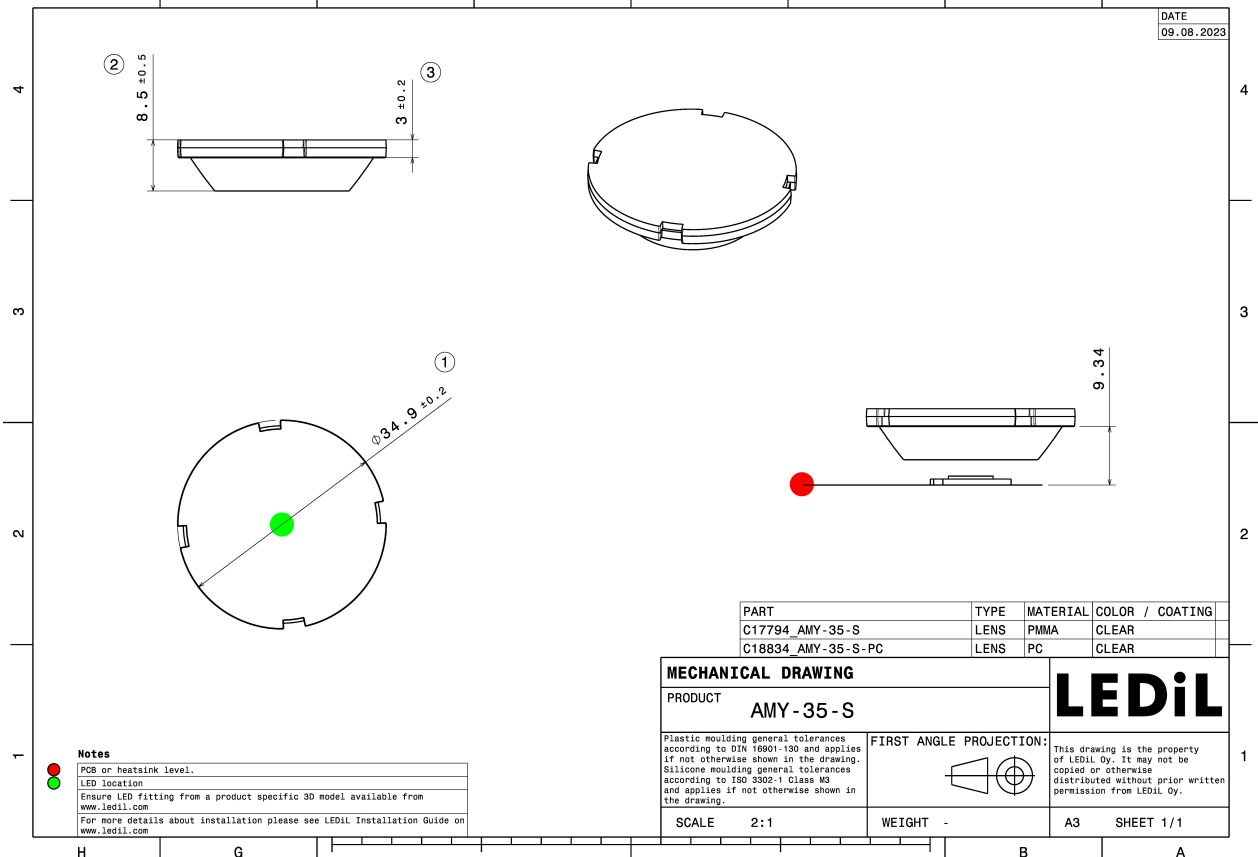
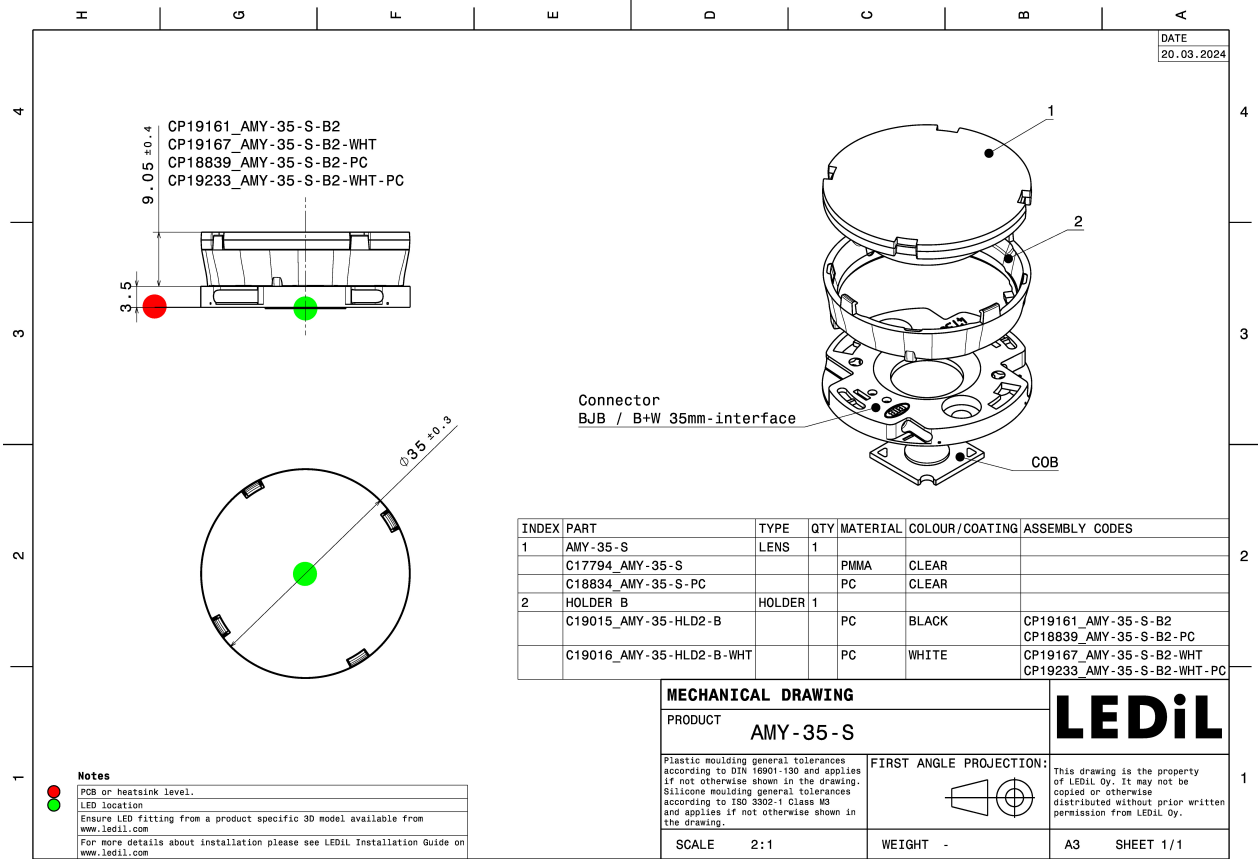

See also our general installation guide: www.ledil.com/installation_guide

OPTICAL RESULTS (MEASURED):



LED Vesta TW 6mm DP
Ordering code CP19161_AMY-35-S-B2
FWHM / FWTM 22.0° / 47.0°
Efficiency 88 %
LEDs/each optic 1
Light colour/type White
Required components:
 Bender Wirth: 504 Typ B35L

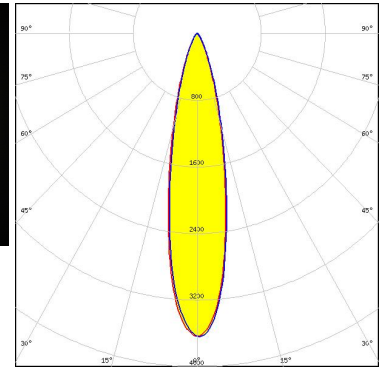
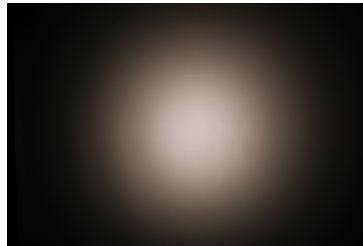

Light distribution files

CITIZEN

LED CLU700/701/702/703
Ordering code CP19161_AMY-35-S-B2
FWHM / FWTM 19.0° / 41.0°
Efficiency 89 %
LEDs/each optic 1
Light colour/type White
Required components:
 BJB: 47.360.1020

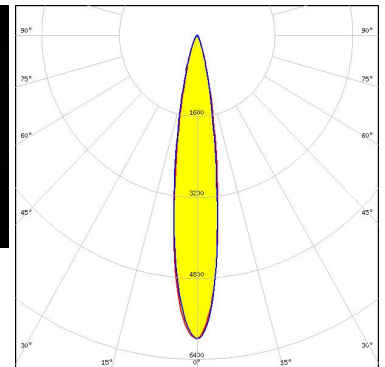
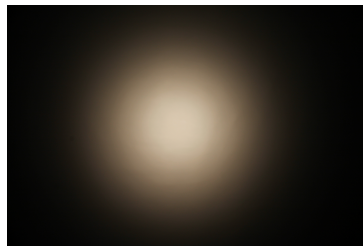

Light distribution files

CITIZEN

LED CLU700/701/702/703
Ordering code CP19161_AMY-35-S-B2
FWHM / FWTM 17.0° / 36.0°
Efficiency 90 %
LEDs/each optic 1
Light colour/type White
Required components:
 Bender Wirth: 634a Bayonet35L

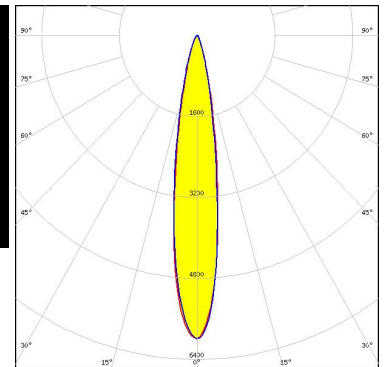
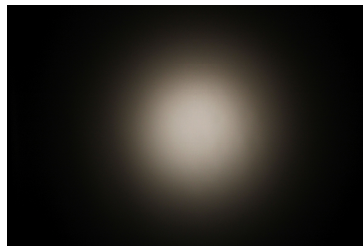

Light distribution files

OPTICAL RESULTS (MEASURED):

CITIZEN

LED CLU700/701/702/703
 Ordering code C17794_AMY-35-S
 FWHM / FWTM 19.0° / 41.0°
 Efficiency 89 %
 LEDs/each optic 1
 Light colour/type White
 Required components:

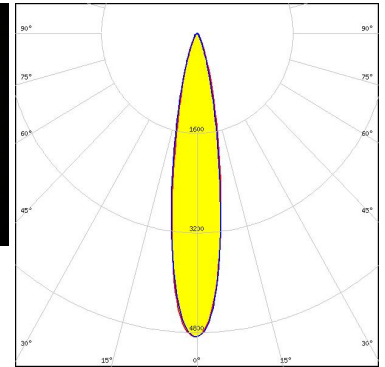

Light distribution files

CITIZEN

LED CLU7L3
 Ordering code CP19161_AMY-35-S-B2
 FWHM / FWTM 11.0° / 26.0°
 Efficiency 91 %
 Peak intensity 11.4 cd/lm
 LEDs/each optic 1
 Light colour/type White
 Required components:
 C19425_SOCKET-B-35-N

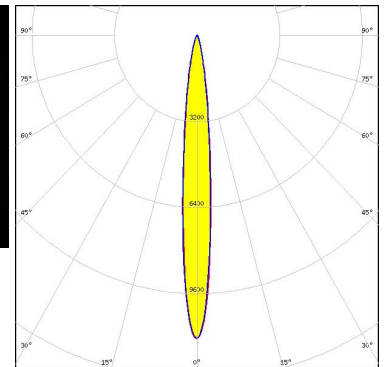

Light distribution files

CITIZEN

LED CLU7L3
 Ordering code CP19161_AMY-35-S-B2
 FWHM / FWTM 12.0° / 25.0°
 Efficiency 92 %
 LEDs/each optic 1
 Light colour/type White
 Required components:
 Bender Wirth: 667a Bayonet35

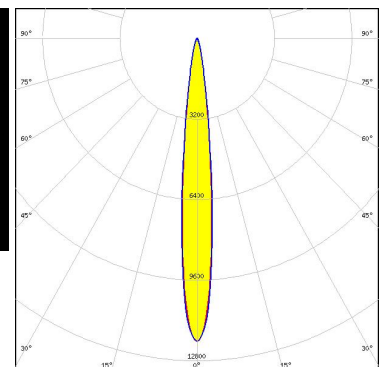
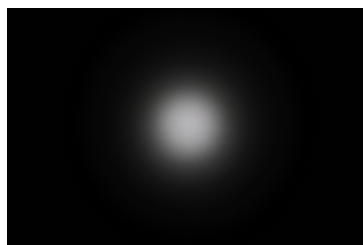

Light distribution files

OPTICAL RESULTS (MEASURED):

CITIZEN

LED CLU7R3
 Ordering code CP19161_AMY-35-S-B2
 FWHM / FWTM 16.0° / 35.0°
 Efficiency 91 %
 Peak intensity 6.6 cd/lm
 LEDs/each optic 1
 Light colour/type White
 Required components:
 C19424_SOCKET-B-35-M

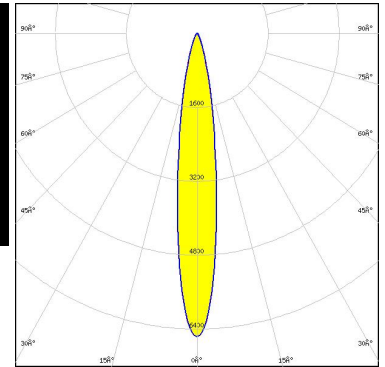

Light distribution files

CITIZEN

LED CLU7S3
 Ordering code CP19161_AMY-35-S-B2
 FWHM / FWTM 13.0° / 31.0°
 Efficiency 91 %
 LEDs/each optic 1
 Light colour/type White
 Required components:
 Bender Wirth: 667a Bayonet35

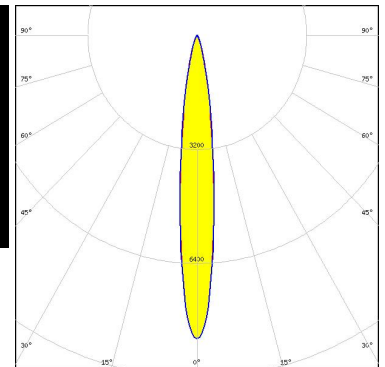

Light distribution files

CITIZEN

LED CLU7S3
 Ordering code CP17970_AMY-35-S-B
 FWHM / FWTM 14.0° / 33.0°
 Efficiency 91 %
 Peak intensity 7.8 cd/lm
 LEDs/each optic 1
 Light colour/type White
 Required components:
 C19425_SOCKET-B-35-N

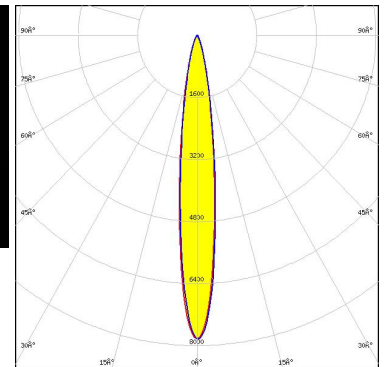
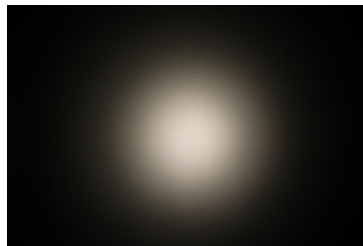

Light distribution files

OPTICAL RESULTS (MEASURED):



LED CMU10xx
Ordering code CP19161_AMY-35-S-B2
FWHM / FWTM 29.0° / 58.0°
Efficiency 88 %
LEDs/each optic 1
Light colour/type White
Required components:
BJB: 47.360.1020

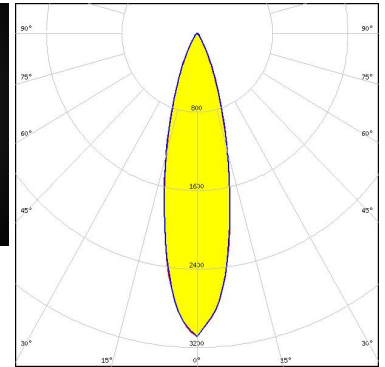
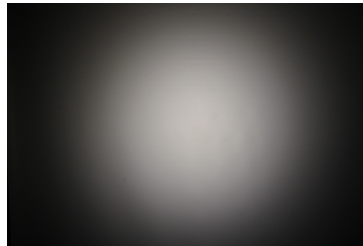

Light distribution files



LED LUXEON 7070
Ordering code CP19161_AMY-35-S-B2
FWHM / FWTM 19.0° / 42.0°
Efficiency 90 %
LEDs/each optic 1
Light colour/type White
Required components:
Bender Wirth: 634a Bayonet35L

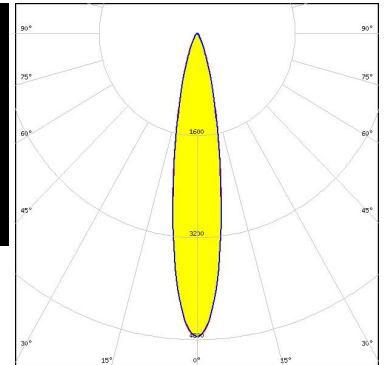

Light distribution files



LED CTM-9 (Tunable White)
Ordering code CP19161_AMY-35-S-B2
FWHM / FWTM 30.0° / 59.0°
Efficiency 85 %
LEDs/each optic 1
Light colour/type White
Required components:
Bender Wirth: 495 Typ B35L

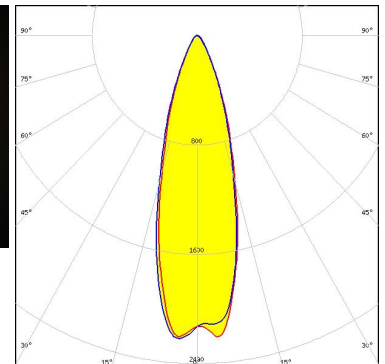
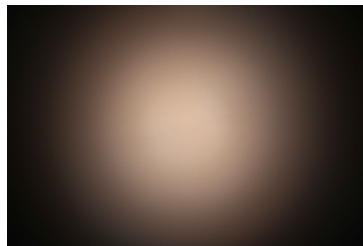

Light distribution files

OPTICAL RESULTS (SIMULATED):



LED V10 Gen 8-9
Ordering code CP19161_AMY-35-S-B2
FWHM / FWTM 26.0° / 53.0°
Efficiency 88 %
Peak intensity 3 cd/lm
LEDs/each optic 1
Light colour/type White
Required components:

BJB: 47.360.1020

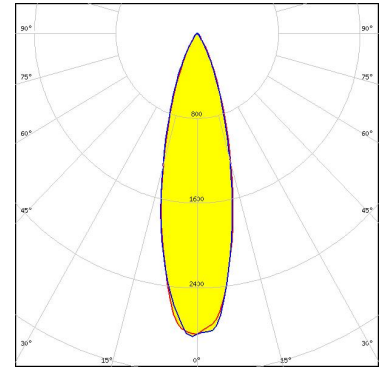

Light distribution files



LED V10 Gen 8-9
Ordering code CP19161_AMY-35-S-B2
FWHM / FWTM 28.0° / 56.0°
Efficiency 90 %
Peak intensity 2.9 cd/lm
LEDs/each optic 1
Light colour/type White
Required components:

Bender Wirth: 634b Bayonet35L

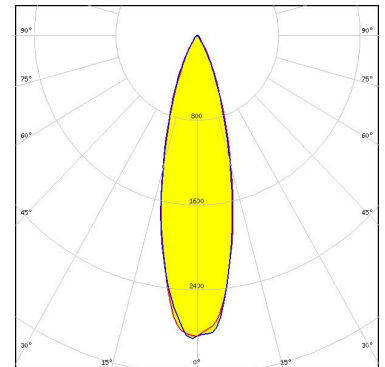

Light distribution files



LED V3 HD Gen 8 FC
Ordering code CP19161_AMY-35-S-B2
FWHM / FWTM 18.0° / 37.0°
Efficiency 94 %
Peak intensity 7.1 cd/lm
LEDs/each optic 1
Light colour/type White
Required components:

Bender Wirth: 634c Bayonet35L

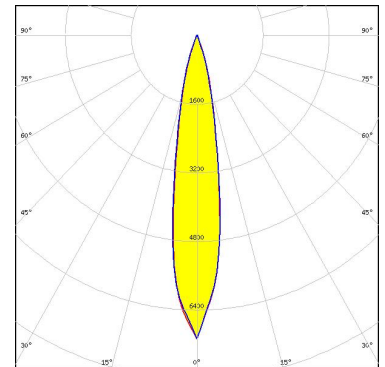

Light distribution files

OPTICAL RESULTS (SIMULATED):



LED V6 HD Gen 8
Ordering code CP19161_AMY-35-S-B2
FWHM / FWTM 20.0° / 43.0°
Efficiency 91 %
Peak intensity 5 cd/lm
LEDs/each optic 1
Light colour/type White
Required components:

Bender Wirth: 634c Bayonet35L

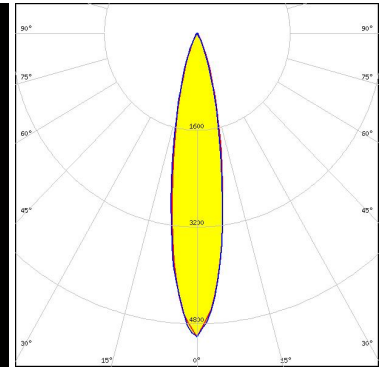
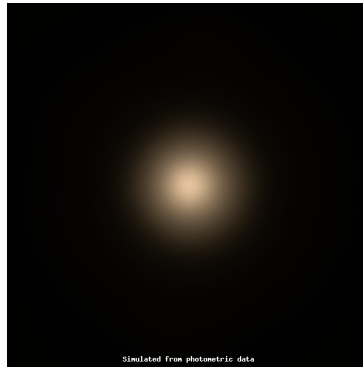

Light distribution files



LED V6 HD Gen 8
Ordering code CP19161_AMY-35-S-B2
FWHM / FWTM 18.0° / 41.0 + 40.0°
Efficiency 90 %
Peak intensity 5.5 cd/lm
LEDs/each optic 1
Light colour/type White
Required components:
 C18968_SOCKET-B-35-C

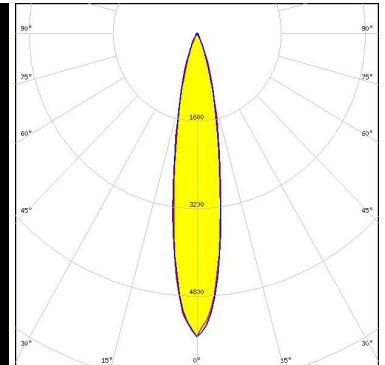
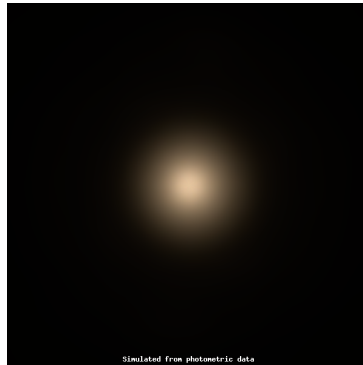

Light distribution files



LED V8 Gen 8-9
Ordering code CP19161_AMY-35-S-B2
FWHM / FWTM 20.0° / 45.0°
Efficiency 89 %
Peak intensity 4.5 cd/lm
LEDs/each optic 1
Light colour/type White
Required components:
 C19309_SOCKET-B-35-L

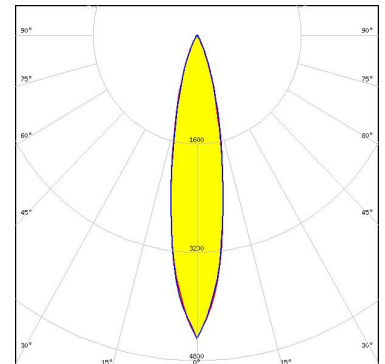

Light distribution files

OPTICAL RESULTS (SIMULATED):



LED Vesta DTW 6mm
Ordering code CP19161_AMY-35-S-B2
FWHM / FWTM 22.0° / 44.0°
Efficiency 92 %
Peak intensity 4.7 cd/lm
LEDs/each optic 1
Light colour/type White
Required components:

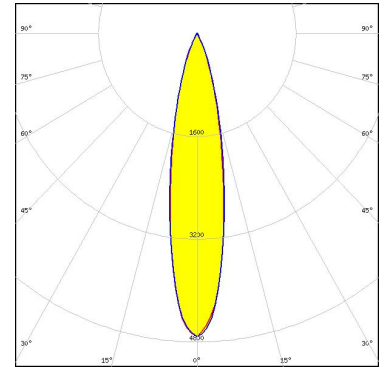

Bender Wirth: 652b Bayonet35L

Light distribution files



LED Vesta DTW 9mm (4W/6W/12W)
Ordering code CP19161_AMY-35-S-B2
FWHM / FWTM 27.0° / 51.0°
Efficiency 90 %
Peak intensity 3.3 cd/lm
LEDs/each optic 1
Light colour/type White
Required components:

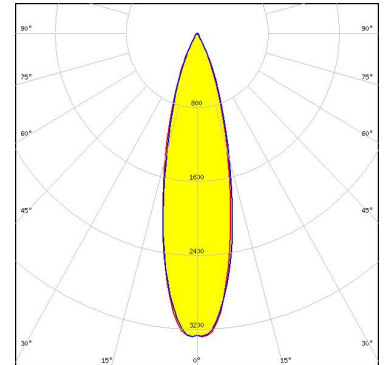

Bender Wirth: 652b Bayonet35L

Light distribution files

CITIZEN

LED CLU02x (LES10)
Ordering code CP19161_AMY-35-S-B2
FWHM / FWTM 27.0° / 55.0°
Efficiency 88 %
Peak intensity 2.9 cd/lm
LEDs/each optic 1
Light colour/type White
Required components:

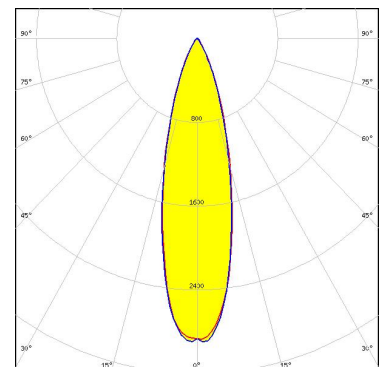

BJB: 47.360.1020

Light distribution files

OPTICAL RESULTS (SIMULATED):

CITIZEN

LED CLU700/701/702/703
Ordering code CP19161_AMY-35-S-B2
FWHM / FWTM 18.0° / 38.0°
Efficiency 90 %
Peak intensity 6.2 cd/lm
LEDs/each optic 1
Light colour/type White
Required components:

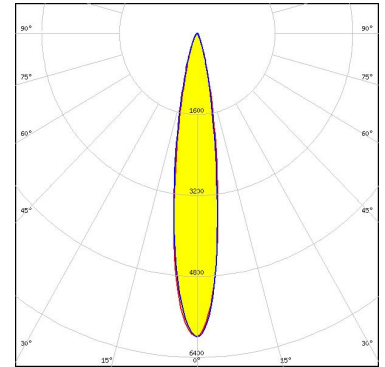

BJB: 47.360.1020

Light distribution files

CITIZEN

LED CLU700/701/702/703
Ordering code CP19161_AMY-35-S-B2
FWHM / FWTM 18.0° / 40.0°
Efficiency 89 %
Peak intensity 5.8 cd/lm
LEDs/each optic 1
Light colour/type White
Required components:

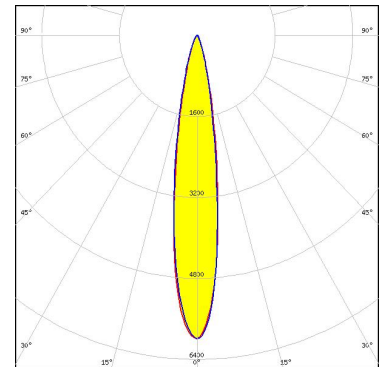

BJB: 47.360.1020

Light distribution files

CITIZEN

LED CLU703 Type-F
Ordering code CP19161_AMY-35-S-B2
FWHM / FWTM 22.0° / 46.0°
Efficiency 91 %
Peak intensity 4.3 cd/lm
LEDs/each optic 1
Light colour/type White
Required components:

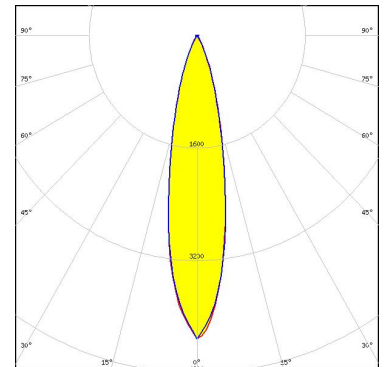

BJB: 47.360.1020

Light distribution files

OPTICAL RESULTS (SIMULATED):

CITIZEN

LED CLU7A2/7A3
Ordering code CP19161_AMY-35-S-B2
FWHM / FWTM 14.0° / 32.0°
Efficiency 92 %
Peak intensity 8.8 cd/lm
LEDs/each optic 1
Light colour/type White
Required components:

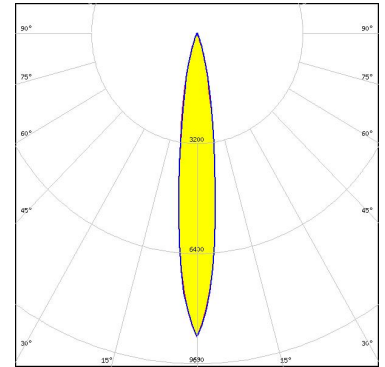

BJB: 47.360.1020

Light distribution files

CITIZEN

LED CLU7A3 Type-F
Ordering code CP19161_AMY-35-S-B2
FWHM / FWTM 24.0° / 45.0°
Efficiency 92 %
Peak intensity 4.4 cd/lm
LEDs/each optic 1
Light colour/type White
Required components:

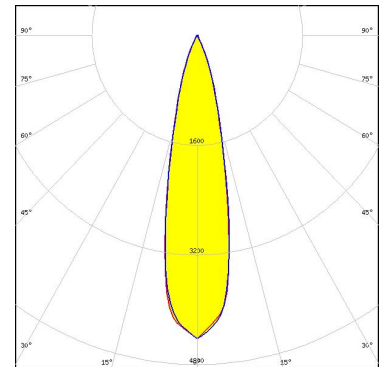

BJB: 47.360.1020

Light distribution files

CITIZEN

LED CLU7B2
Ordering code CP19161_AMY-35-S-B2
FWHM / FWTM 14.0° / 30.0°
Efficiency 92 %
Peak intensity 10 cd/lm
LEDs/each optic 1
Light colour/type White
Required components:

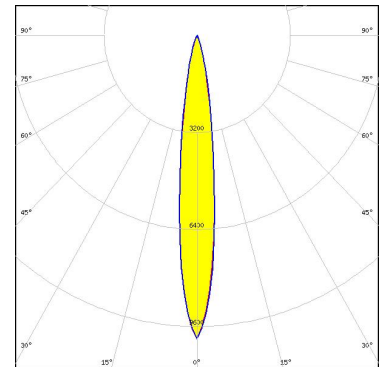

BJB: 47.360.1020

Light distribution files

OPTICAL RESULTS (SIMULATED):

CITIZEN

LED CLU7L3
Ordering code CP19161_AMY-35-S-B2
FWHM / FWTM 14.0° / 30.0°
Efficiency 89 %
Peak intensity 9.8 cd/lm
LEDs/each optic 1
Light colour/type White
Required components:
C19425_SOCKET-B-35-N

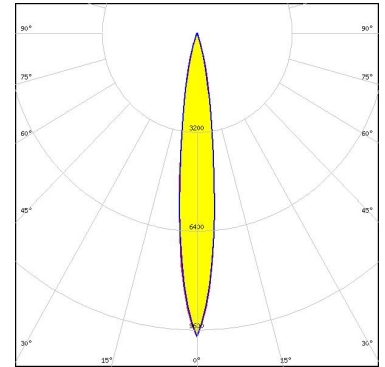

Light distribution files

CITIZEN

LED CLU7S3
Ordering code CP19161_AMY-35-S-B2
FWHM / FWTM 16.0° / 34.0°
Efficiency 88 %
Peak intensity 8.1 cd/lm
LEDs/each optic 1
Light colour/type White
Required components:
C19425_SOCKET-B-35-N

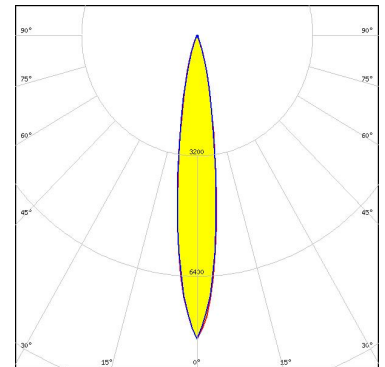

Light distribution files



LED CMA1303
Ordering code CP19161_AMY-35-S-B2
FWHM / FWTM 14.0° / 33.0°
Efficiency 93 %
Peak intensity 8.7 cd/lm
LEDs/each optic 1
Light colour/type White
Required components:

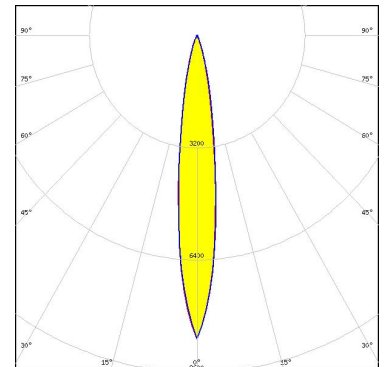

Bender Wirth: 634c Bayonet35L

Light distribution files

OPTICAL RESULTS (SIMULATED):



LED CMA1306
Ordering code CP19161_AMY-35-S-B2
FWHM / FWTM 19.0° / 41.0°
Efficiency 91 %
Peak intensity 5.6 cd/lm
LEDs/each optic 1
Light colour/type White
Required components:

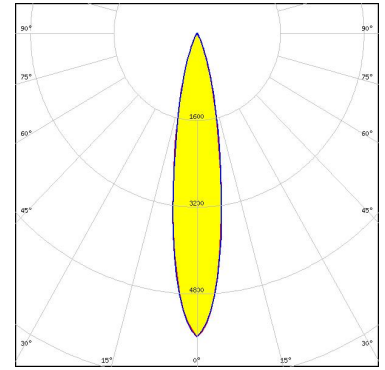

Bender Wirth: 634c Bayonet35L

Light distribution files



LED CMU10xx
Ordering code CP19161_AMY-35-S-B2
FWHM / FWTM 26.0° / 53.0°
Efficiency 87 %
Peak intensity 3.1 cd/lm
LEDs/each optic 1
Light colour/type White
Required components:

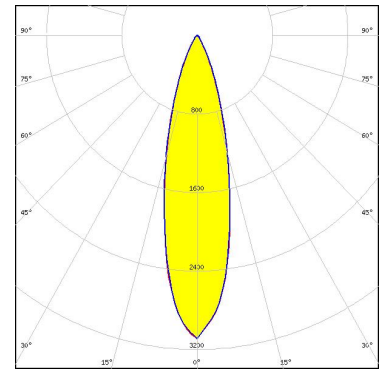

BJB: 47.360.1020

Light distribution files



LED CXA/B 15xx
Ordering code CP19161_AMY-35-S-B2
FWHM / FWTM 26.0° / 52.0°
Efficiency 87 %
Peak intensity 3.2 cd/lm
LEDs/each optic 1
Light colour/type White
Required components:

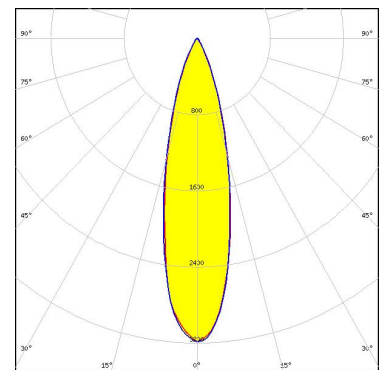

BJB: 47.360.1030

Light distribution files

OPTICAL RESULTS (SIMULATED):



LED CXA/B 15xx
Ordering code CP19161_AMY-35-S-B2
FWHM / FWTM 24.0° / 50.0°
Efficiency 88 %
Peak intensity 3.5 cd/lm
LEDs/each optic 1
Light colour/type White
Required components:

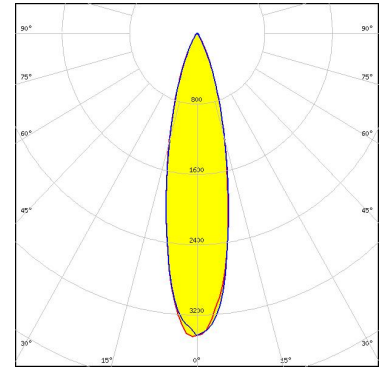

BJB: 47.360.1030

Light distribution files



LED LUXEON 7070
Ordering code C17794_AMY-35-S
FWHM / FWTM 17.0° / 38.0°
Efficiency 94 %
Peak intensity 6.2 cd/lm
LEDs/each optic 1
Light colour/type White
Required components:

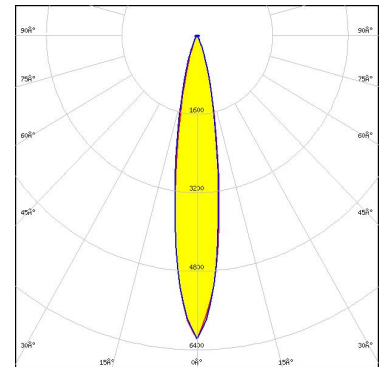

Light distribution files



LED LUXEON CoB 1202/1203
Ordering code CP19161_AMY-35-S-B2
FWHM / FWTM 26.0° / 53.0°
Efficiency 90 %
Peak intensity 3.3 cd/lm
LEDs/each optic 1
Light colour/type White
Required components:

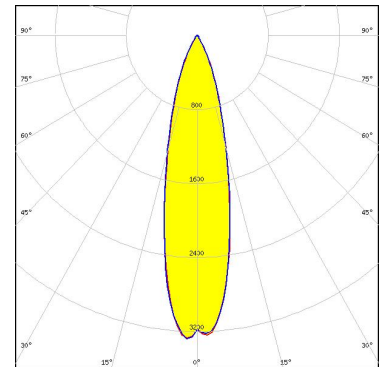

BJB: 47.360.1110

Light distribution files

OPTICAL RESULTS (SIMULATED):



LED LUXEON CoB 1202HD
Ordering code CP19161_AMY-35-S-B2
FWHM / FWTM 21.0° / 44.0°
Efficiency 93 %
Peak intensity 4.8 cd/lm
LEDs/each optic 1
Light colour/type White
Required components:

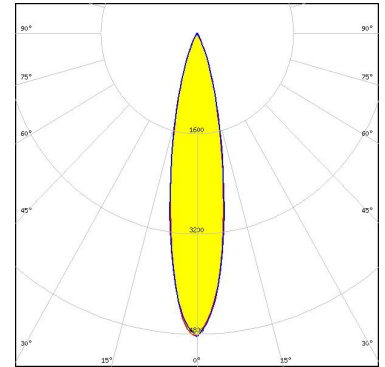

Bender Wirth: 652a Bayonet35L

Light distribution files



LED LUXEON CX Plus CoB - HD S01H4
Ordering code CP19161_AMY-35-S-B2
FWHM / FWTM 16.0° / 34.0°
Efficiency 90 %
Peak intensity 7.4 cd/lm
LEDs/each optic 1
Light colour/type White
Required components:

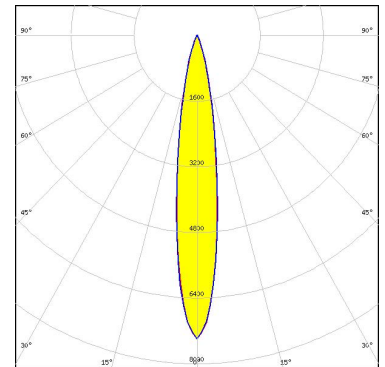

Bender Wirth: 634c Bayonet35L

Light distribution files



LED LUXEON CX Plus CoB - HD S02H6
Ordering code CP19161_AMY-35-S-B2
FWHM / FWTM 20.0° / 43.0°
Efficiency 92 %
Peak intensity 5.2 cd/lm
LEDs/each optic 1
Light colour/type White
Required components:

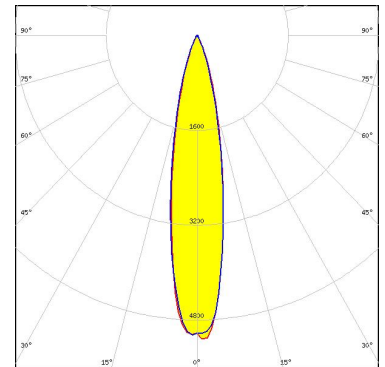

Bender Wirth: 634c Bayonet35L

Light distribution files

OPTICAL RESULTS (SIMULATED):

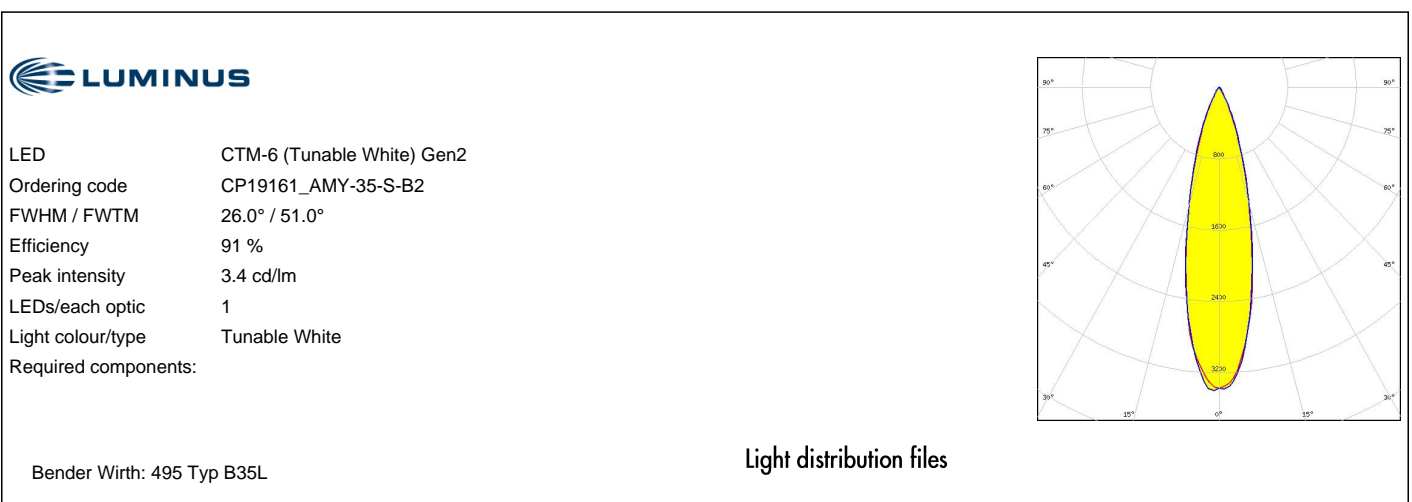
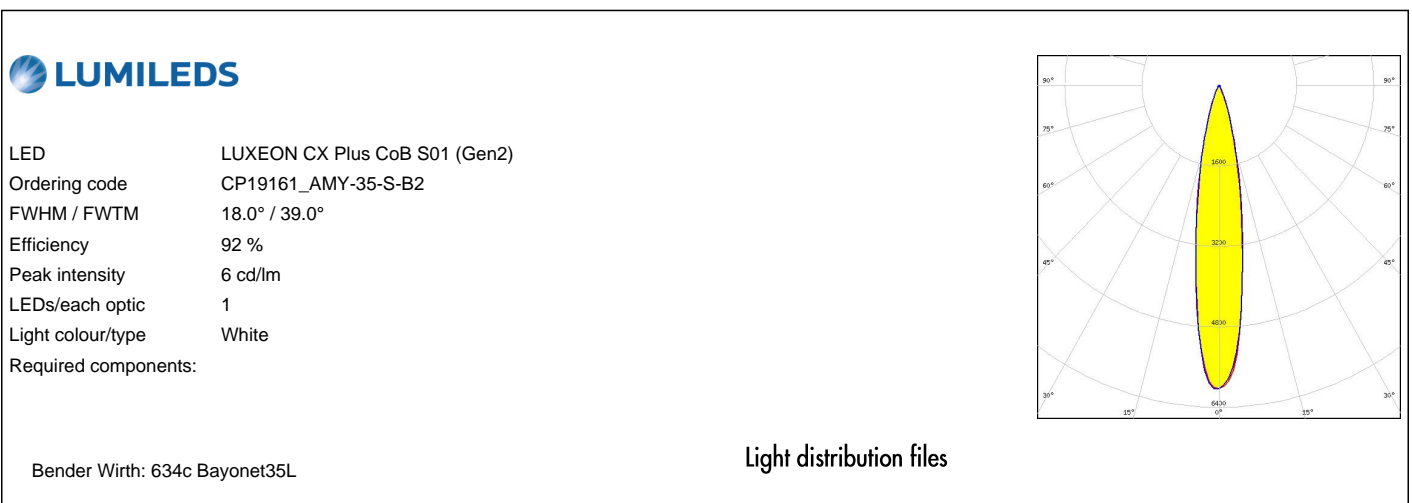
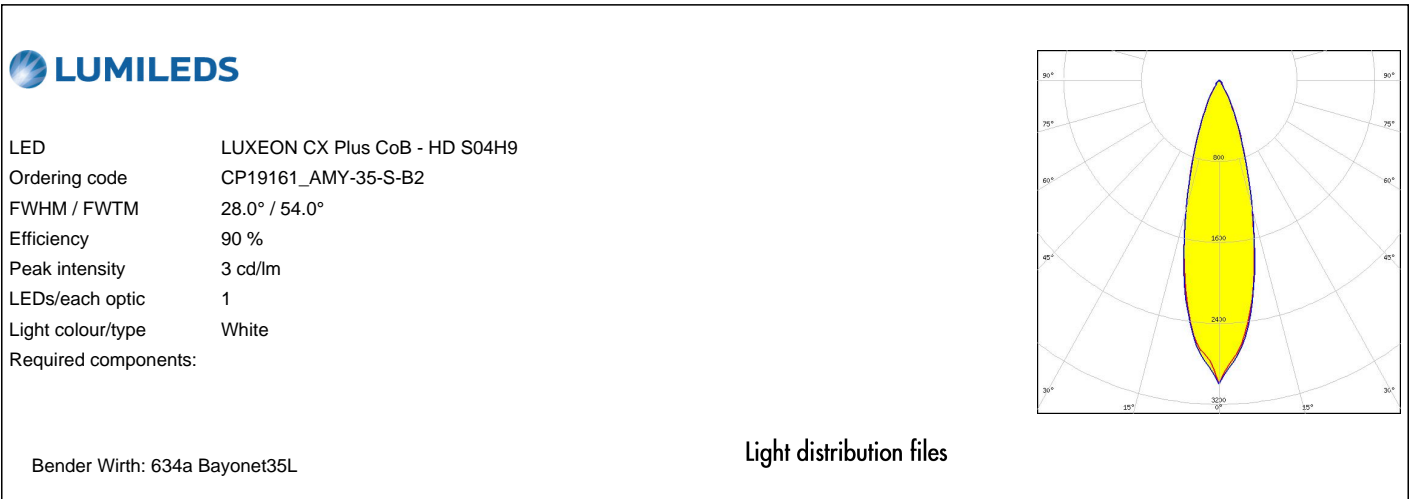

OPTICAL RESULTS (SIMULATED):

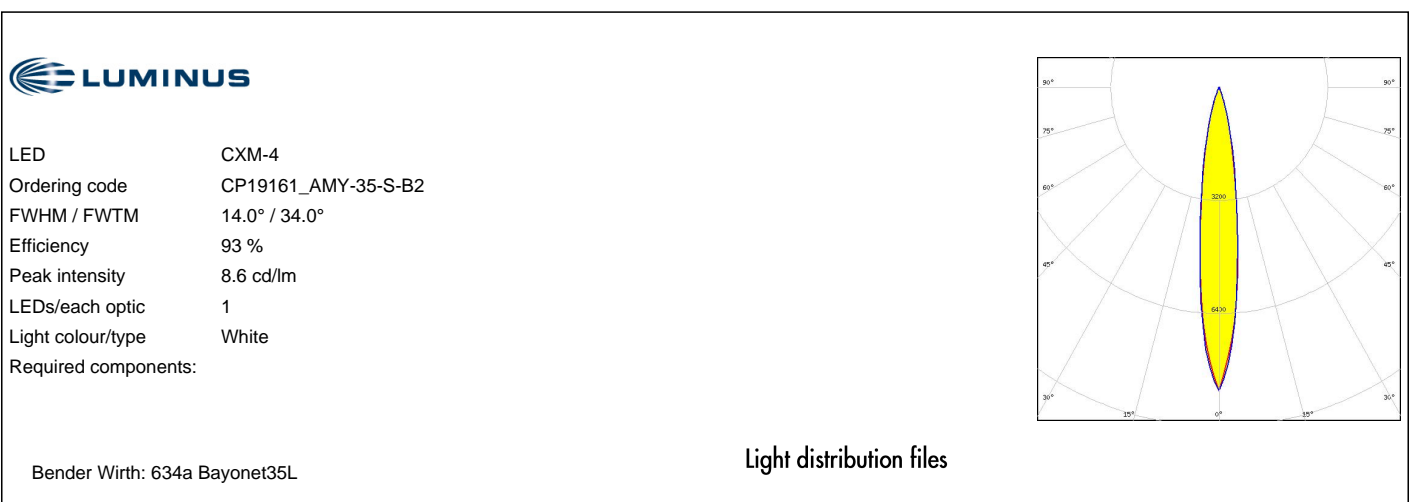
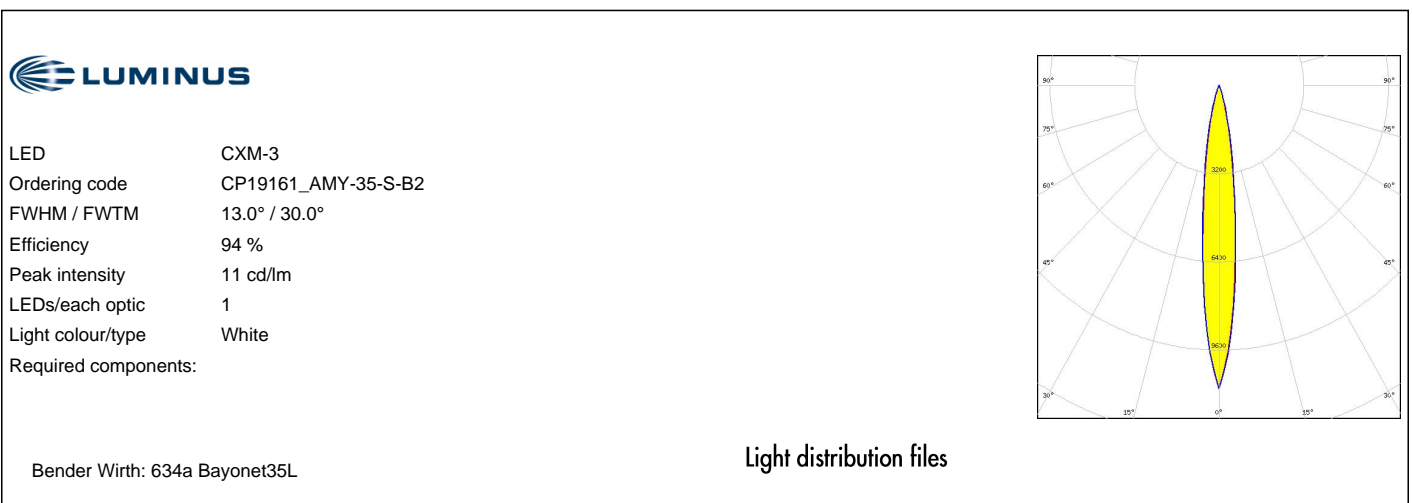
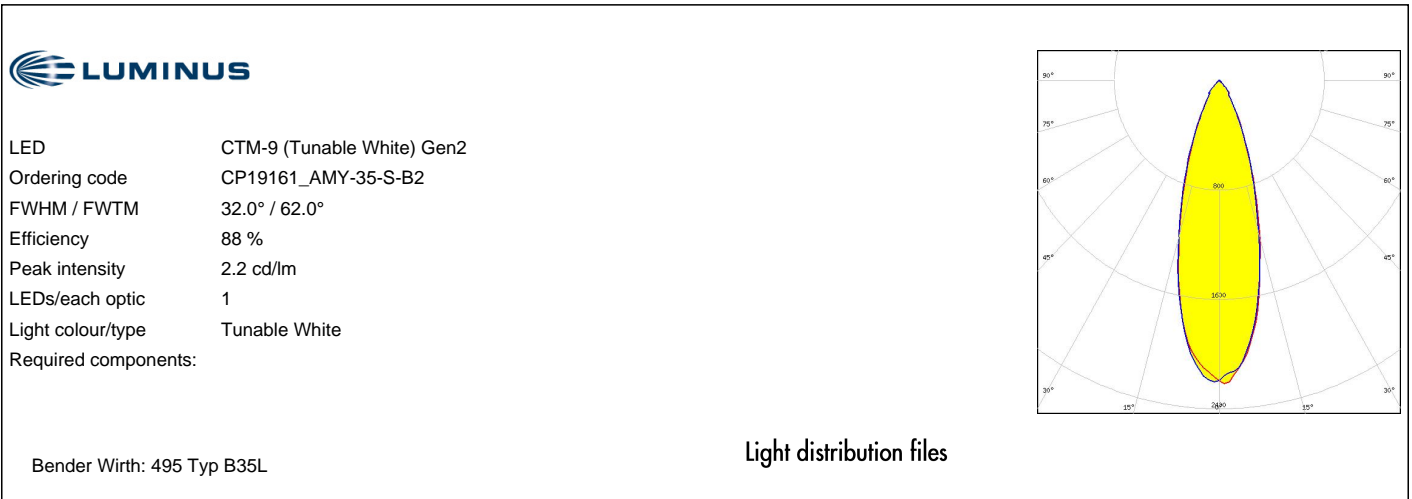

OPTICAL RESULTS (SIMULATED):



LED CxM-6 (13.5x13.5)
Ordering code CP19167_AMY-35-S-B2-WHT
FWHM / FWTM 18.0° / 41.0°
Efficiency 92 %
Peak intensity 5.5 cd/lm
LEDs/each optic 1
Light colour/type White
Required components:

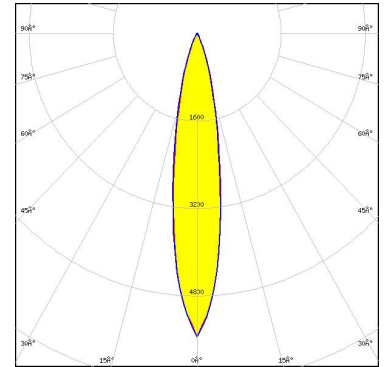

Bender Wirth: 634a Bayonet35L

Light distribution files



LED CxM-6 (13.5x13.5)
Ordering code CP19161_AMY-35-S-B2
FWHM / FWTM 18.0° / 41.0°
Efficiency 92 %
Peak intensity 5.8 cd/lm
LEDs/each optic 1
Light colour/type White
Required components:

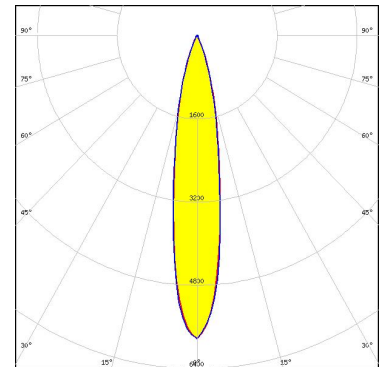

BJB: 47.360.1020

Light distribution files



LED COB S-Type (LES 6)
Ordering code CP19161_AMY-35-S-B2
FWHM / FWTM 18.0° / 40.0°
Efficiency 92 %
Peak intensity 5.8 cd/lm
LEDs/each optic 1
Light colour/type White
Required components:

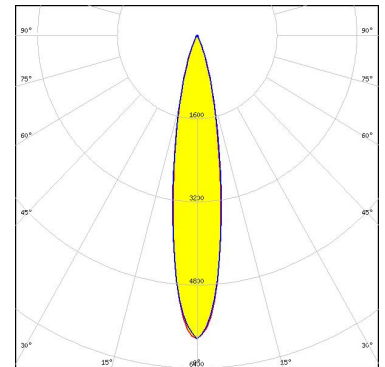

Bender Wirth: 652a Bayonet35L

Light distribution files

OPTICAL RESULTS (SIMULATED):



LED COB S-Type (LES 7)
Ordering code CP19161_AMY-35-S-B2
FWHM / FWTM 20.0° / 42.0°
Efficiency 92 %
Peak intensity 5.3 cd/lm
LEDs/each optic 1
Light colour/type White
Required components:

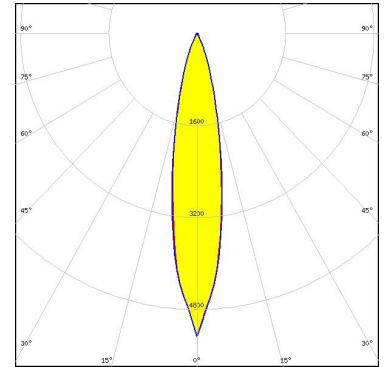

Bender Wirth: 652a Bayonet35L

Light distribution files



LED COB T-Type
Ordering code CP19161_AMY-35-S-B2
FWHM / FWTM 19.0° / 41.0°
Efficiency 92 %
Peak intensity 5.7 cd/lm
LEDs/each optic 1
Light colour/type White
Required components:

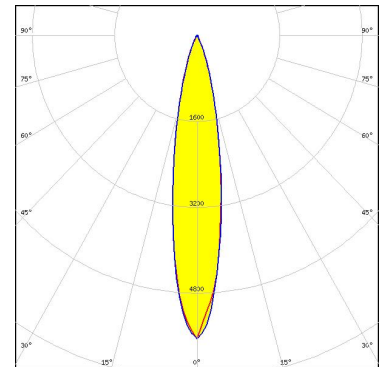

Bender Wirth: 652a Bayonet35L

Light distribution files



LED NVSW219C-V2
FWHM / FWTM 10.0° / 22.0°
Efficiency 89 %
Peak intensity 16.7 cd/lm
LEDs/each optic 1
Light colour/type White
Required components:

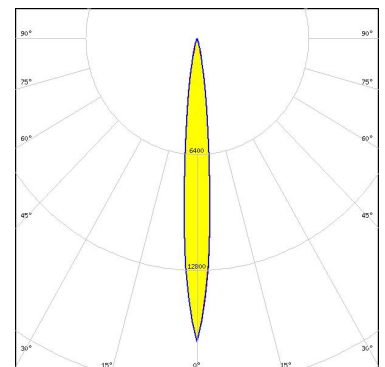

BJB: 47.360.1010

Light distribution files

OPTICAL RESULTS (SIMULATED):

PHILIPS

LED Fortimo SLM L09 CoB
Ordering code CP19167_AMY-35-S-B2-WHT
FWHM / FWTM 20.0° / 43.0°
Efficiency 94 %
Peak intensity 5.3 cd/lm
LEDs/each optic 1
Light colour/type White
Required components:

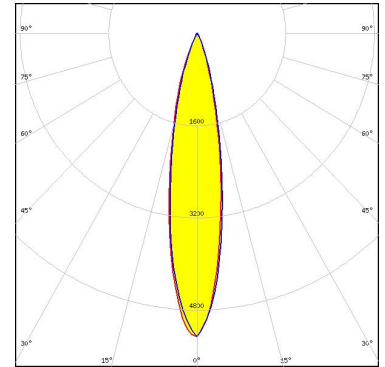

Bender Wirth: 634a Bayonet35L

Light distribution files

PHILIPS

LED Fortimo SLM L09 CoB
Ordering code CP19167_AMY-35-S-B2-WHT
FWHM / FWTM 27.0° / 52.0°
Efficiency 91 %
Peak intensity 3.1 cd/lm
LEDs/each optic 1
Light colour/type White
Required components:

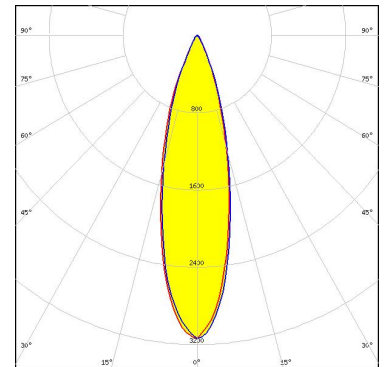

Bender Wirth: 634a Bayonet35L

Light distribution files

SAMSUNG

LED LC003D / LC006D / LC009D / LC013D
Ordering code CP19161_AMY-35-S-B2
FWHM / FWTM 26.0° / 54.0°
Efficiency 82 %
Peak intensity 2.8 cd/lm
LEDs/each optic 1
Light colour/type White
Required components:
C18968_SOCKET-B-35-C

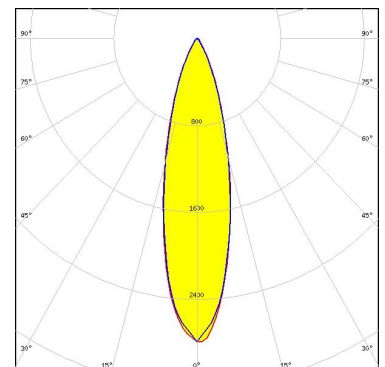

Light distribution files

OPTICAL RESULTS (SIMULATED):

SAMSUNG

LED LC003D / LC006D / LC009D / LC013D
Ordering code CP19161_AMY-35-S-B2
FWHM / FWTM 26.0° / 53.0°
Efficiency 90 %
Peak intensity 3.2 cd/lm
LEDs/each optic 1
Light colour/type White
Required components:

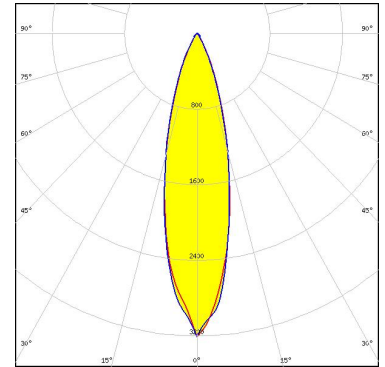

BJB: 47.360.1020

Light distribution files

SAMSUNG

LED LC010C G2
Ordering code CP19161_AMY-35-S-B2
FWHM / FWTM 16.0° / 40.0°
Efficiency 92 %
Peak intensity 6.5 cd/lm
LEDs/each optic 1
Light colour/type White
Required components:

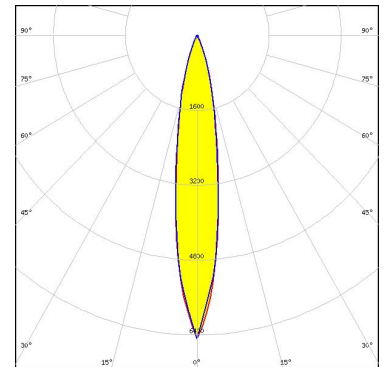

BJB: 47.360.1020

Light distribution files

SAMSUNG

LED LH502D
Ordering code CP19161_AMY-35-S-B2
FWHM / FWTM 12.0° / 30.0°
Efficiency 88 %
Peak intensity 10.4 cd/lm
LEDs/each optic 1
Light colour/type White
Required components:

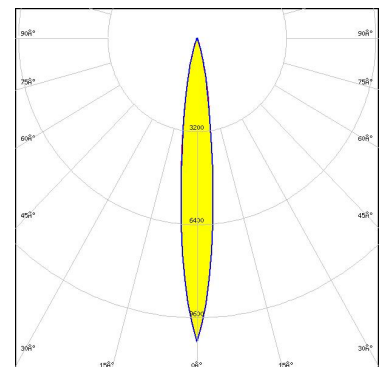

BJB: 47.360.1010

Light distribution files

OPTICAL RESULTS (SIMULATED):

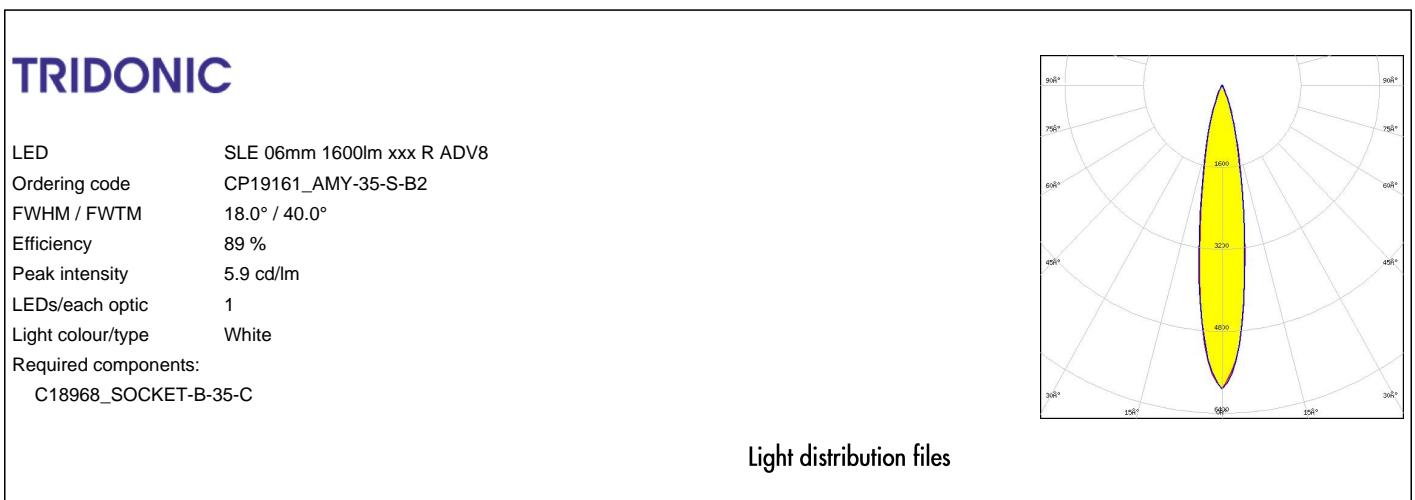
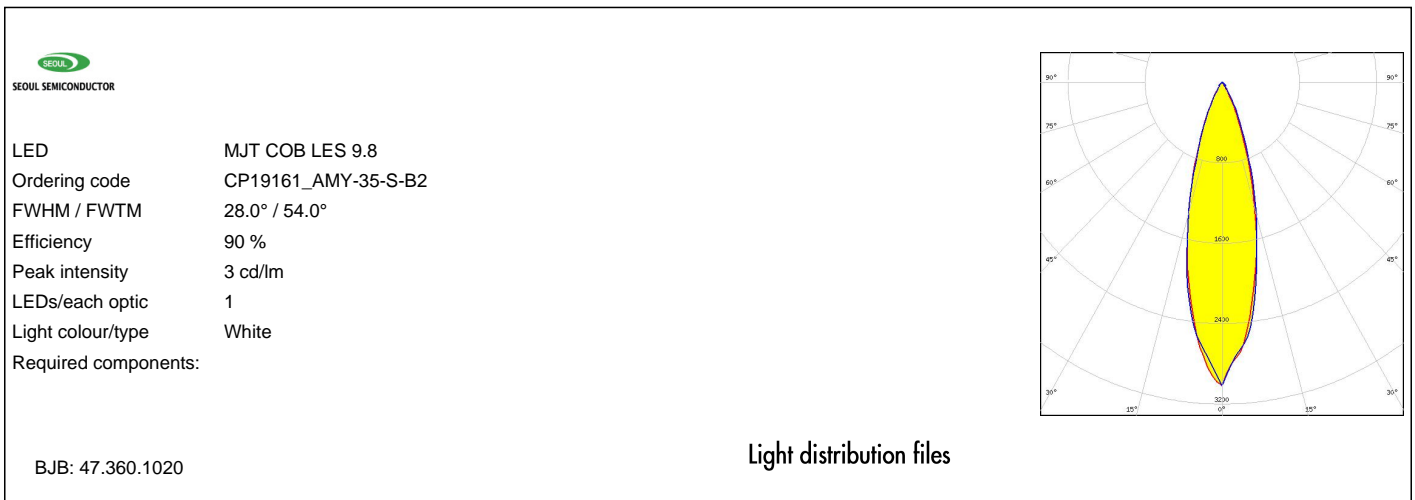
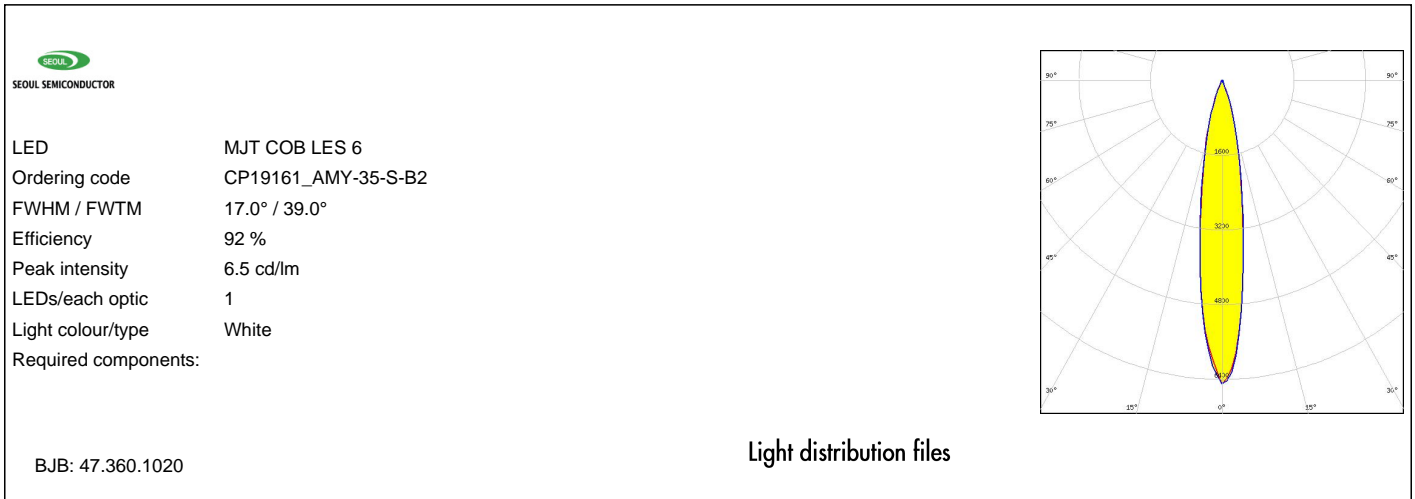

OPTICAL RESULTS (SIMULATED):

TRIDONIC

LED	SLE SNC8 LES06
Ordering code	CP19161_AMY-35-S-B2
FWHM / FWTM	18.0° / 40.0°
Efficiency	92 %
Peak intensity	6.1 cd/lm
LEDs/each optic	1
Light colour/type	White
Required components:	

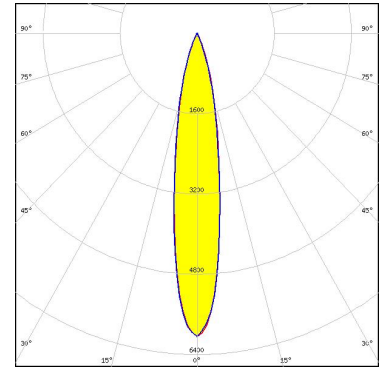

BJB: 47.360.1020

Light distribution files

XICATO

LED	XOB 6 mm
Ordering code	C17794_AMY-35-S
FWHM / FWTM	17.0° / 36.0°
Efficiency	94 %
Peak intensity	6.6 cd/lm
LEDs/each optic	1
Light colour/type	White
Required components:	

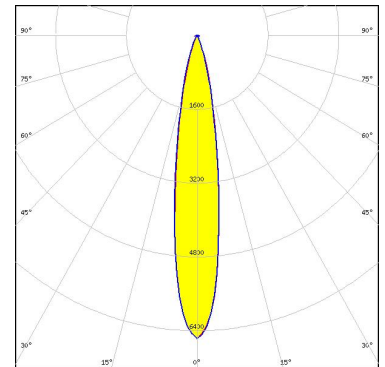

Light distribution files

XICATO

LED	XOB 9.8 mm
Ordering code	C17794_AMY-35-S
FWHM / FWTM	24.0° / 51.0°
Efficiency	92 %
Peak intensity	3.5 cd/lm
LEDs/each optic	1
Light colour/type	White
Required components:	

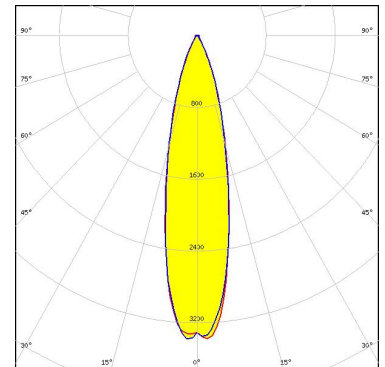

Light distribution files

GENERAL INFORMATION:

NOTE: The typical beam angle will be changed by different color, chip size and chip position tolerance. The typical total beam angle is the full angle measured where the luminous intensity is half of the peak value.

Due to use of high power COB's with this product, special attention to proper thermal design is highly recommended. LEDiL has no liability for direct, indirect or consecutive damages arising from the LEDiL products being used outside of the recommended temperature range.

MATERIALS:

As part of our continuous research and improvement processes, and to ensure the best possible quality and availability of our products, LEDiL reserves the right to change material grades without notice.

PRODUCT DATA USER AGREEMENT AND DISCLAIMER:

The measured data in the provided downloadable LEDiL Product Datasheets and Mechanical 2D-Drawings is rounded and provided as reference for planning. LEDiL Oy's optical specifications have been verified by conducting performance testing of the products in accordance with the company's quality system. The reported data are averaged results of multiple measurements with typical variation. LEDiL Oy reserves the right to without prior notification make changes and improvements to its products.

LEDiL Oy assumes neither warranty, nor guarantee nor any other liability of any kind for the contents and correctness of the provided data. The provided data has been generated with highest diligence but the provided data may in reality not represent the complete possible variation range of all intrinsic parameters. Therefore, in certain cases a deviation from the provided data could occur.

LEDiL Oy reserves the right to undertake technical changes of its products without further notification which could lead to changes in the provided data. LEDiL Oy assumes no liability of any kind for the possible deviation from any provided data or any other damage resulting from the usage of the provided data.

The user agrees to this disclaimer and user agreement with the download or usage of the provided files.

LEDiL Oy

Joensuunkatu 7
FI-24100 SALO
Finland

LEDiL Inc.

228 West Page Street
Suite D
Sycamore IL 60178
USA

Ledil Optics Technology (Shenzhen) Co., Ltd.

405 , Block B
Casic Motor Building
Shenzhen 518057
P.R.CHINA

Local sales and technical support

[www.ledil.com/
where_to_buy](http://www.ledil.com/where_to_buy)

Shipping locations

Poznan, Poland
Hong Kong, China

Distribution Partners

[www.ledil.com/
where_to_buy](http://www.ledil.com/where_to_buy)