

## AMY-50-WAS

Asymmetric beam for wall-washing

### SPECIFICATION:

Dimensions	Ø 49.9
Height	13.6 mm
Fastening	socket
ROHS compliant	yes ⓘ

### MATERIALS:

Component	Type	Material	Colour	Finish	Length (mm)
AMY-50-WAS	Single lens	PMMA	clear		
AMY-50-HLD2-C-ASYM	Holder C	PC	black		
AMY-50-HLD2-B-ASYM	Holder B	PC	black		
AMY-50-HLD2-C-WHT-ASYM	Holder C	PC	white		
AMY-50-HLD2-B-WHT-ASYM	Holder B	PC	white		



### ORDERING INFORMATION:

Component	Qty in box	MOQ	MPQ	Box weight (kg)
C18441_AMY-50-WAS	540	120	30	9.1
<b>Assembly</b>				
CP19156_AMY-50-WAS-B2-WHT	510	120	30	10.3
CP19146_AMY-50-WAS-C2-WHT	510	120	30	9.8
CP19137_AMY-50-WAS-B2	510	120	30	10.3
CP19128_AMY-50-WAS-C2	510	120	30	9.8

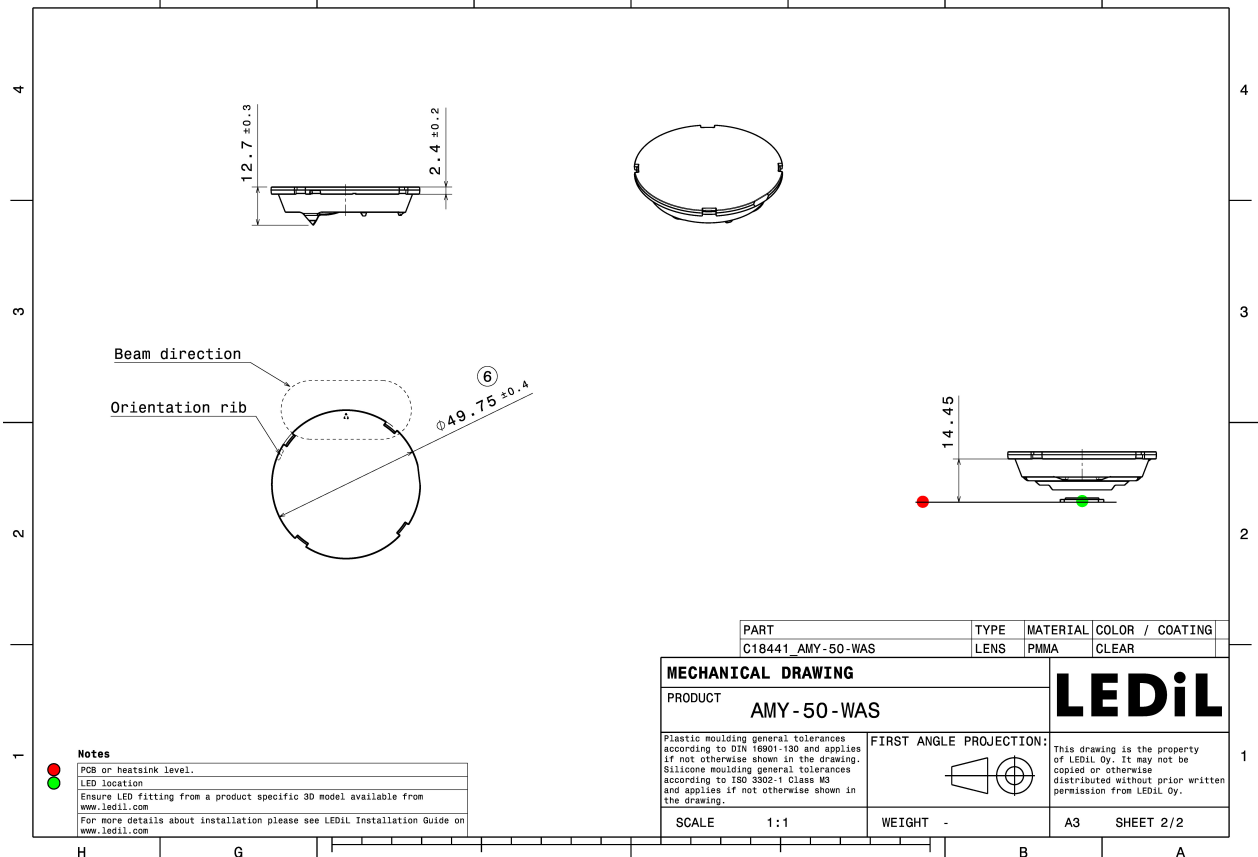
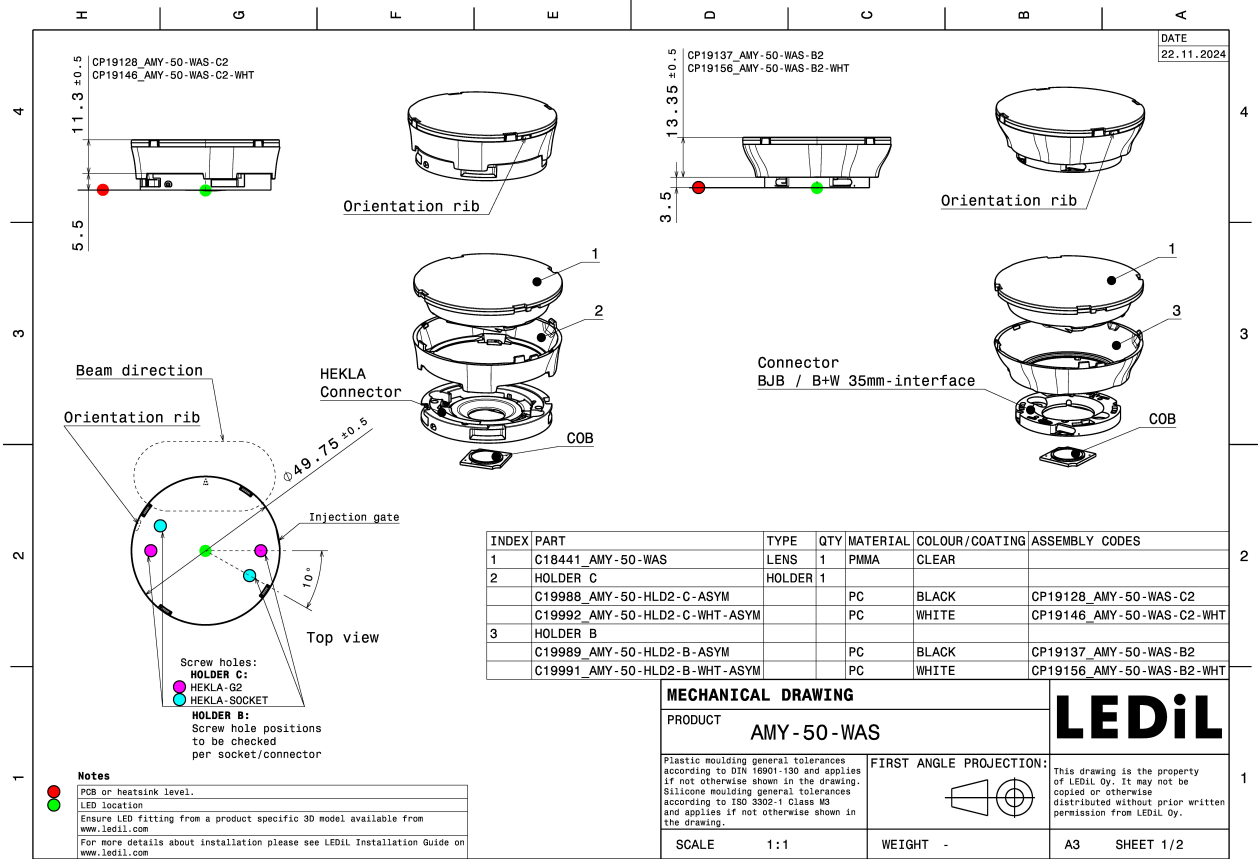

See also our general installation guide: [www.ledil.com/installation\\_guide](http://www.ledil.com/installation_guide)

### OPTICAL RESULTS (MEASURED):



LED Vesta RGBW 10mm CSP  
Ordering code CP19128\_AMY-50-WAS-C2  
FWHM / FWTM Asymmetric  
Efficiency 68 %  
Peak intensity 0.6 cd/lm  
LEDs/each optic 28  
Light colour/type RGBW  
Required components:  
C19950\_HEKLA-SOCKET-RZ

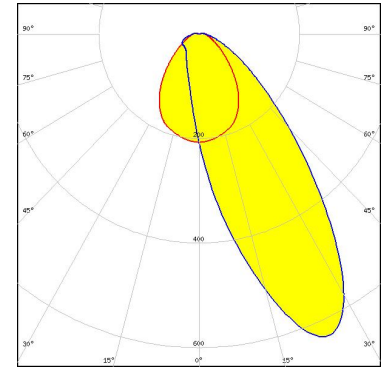

Light distribution files

## PHILIPS

LED Fortimo SLM C TW L09A 1919 G7N  
Ordering code CP19128\_AMY-50-WAS-C2  
FWHM / FWTM Asymmetric  
Efficiency 77 %  
Peak intensity 0.8 cd/lm  
LEDs/each optic 1  
Light colour/type Tunable White  
Required components:  
C16142\_HEKLA-SOCKET-K  
Bender Wirth: 501 Typ L8

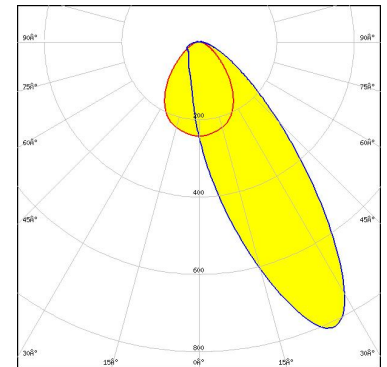

Light distribution files

### OPTICAL RESULTS (SIMULATED):



**LED** V10 Gen 8-9  
**Ordering code** CP19128\_AMY-50-WAS-C2  
**FWHM / FWTM** Asymmetric  
**Efficiency** 83 %  
**Peak intensity** 1 cd/lm  
**LEDs/each optic** 1  
**Light colour/type** White  
**Required components:**  
 F15255\_HEKLA-SOCKET-C

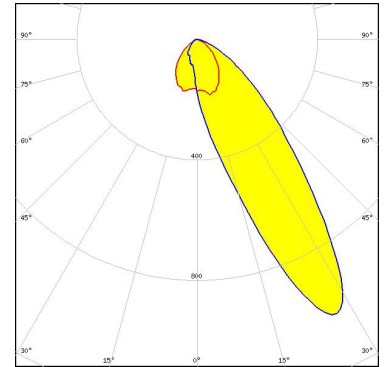

Light distribution files



**LED** V10 Gen 8-9  
**FWHM / FWTM** Asymmetric  
**Efficiency** 82 %  
**Peak intensity** 1 cd/lm  
**LEDs/each optic** 1  
**Light colour/type** White  
**Required components:**  
 F19857\_HEKLA-G2B-C2

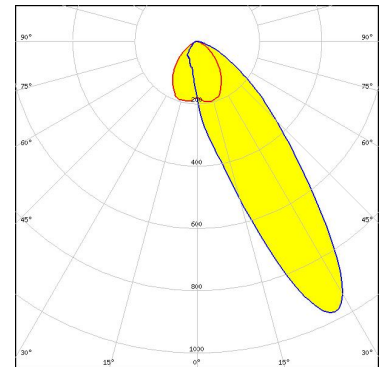

Light distribution files



**LED** V6 HD Gen 8  
**Ordering code** CP19128\_AMY-50-WAS-C2  
**FWHM / FWTM** Asymmetric  
**Efficiency** 85 %  
**Peak intensity** 1.2 cd/lm  
**LEDs/each optic** 1  
**Light colour/type** White  
**Required components:**  
 F15255\_HEKLA-SOCKET-C

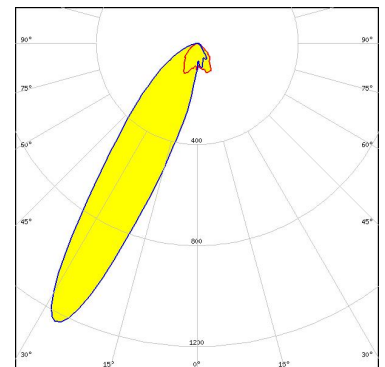

Light distribution files

### OPTICAL RESULTS (SIMULATED):

bridgelux.

LED VERO13  
Ordering code CP19128\_AMY-50-WAS-C2  
FWHM / FWTM Asymmetric  
Efficiency 83 %  
Peak intensity 0.8 cd/lm  
LEDs/each optic 1  
Light colour/type White  
Required components:  
C16142\_HEKLA-SOCKET-K

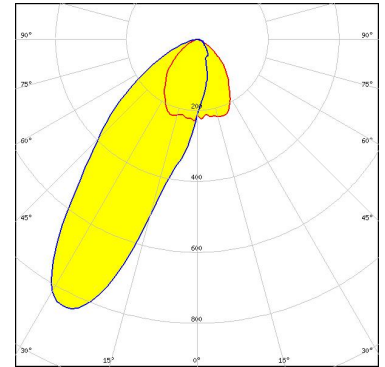

Light distribution files

bridgelux.

LED Vesta DTW 6mm  
Ordering code CP19128\_AMY-50-WAS-C2  
FWHM / FWTM Asymmetric  
Efficiency 85 %  
Peak intensity 1.2 cd/lm  
LEDs/each optic 1  
Light colour/type White  
Required components:

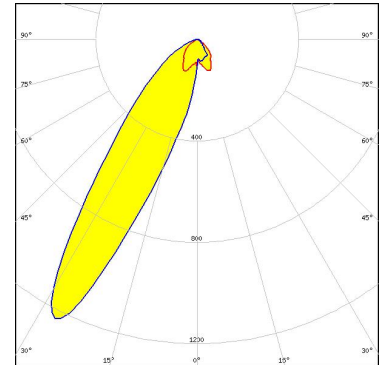

Bender Wirth: 652b Hekla

Light distribution files

bridgelux.

LED Vesta SE 13mm TW  
Ordering code CP19128\_AMY-50-WAS-C2  
FWHM / FWTM Asymmetric  
Efficiency 78 %  
Peak intensity 0.9 cd/lm  
LEDs/each optic 1  
Light colour/type Tunable White  
Required components:  
C16142\_HEKLA-SOCKET-K

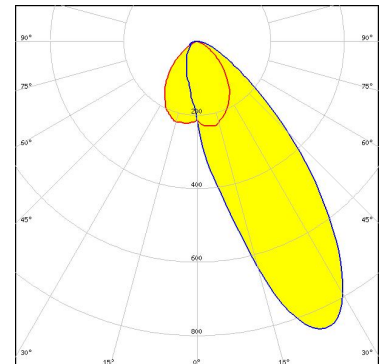

Light distribution files

### OPTICAL RESULTS (SIMULATED):

#### CITIZEN

LED CLU02x (LES10)  
Ordering code CP19128\_AMY-50-WAS-C2  
FWHM / FWTM Asymmetric  
Efficiency 83 %  
Peak intensity 1 cd/lm  
LEDs/each optic 1  
Light colour/type White  
Required components:  
F17435\_HEKLA-G2-C

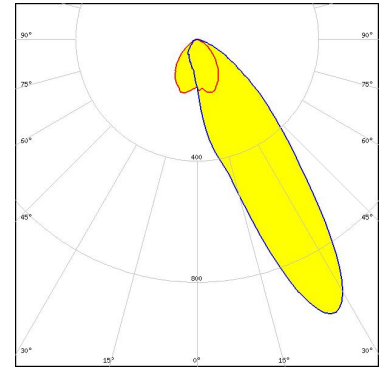

Light distribution files

#### CITIZEN

LED CLU02x (LES10)  
Ordering code CP19146\_AMY-50-WAS-C2-WHT  
FWHM / FWTM Asymmetric  
Efficiency 90 %  
Peak intensity 1 cd/lm  
LEDs/each optic 1  
Light colour/type White  
Required components:  
F17435\_HEKLA-G2-C

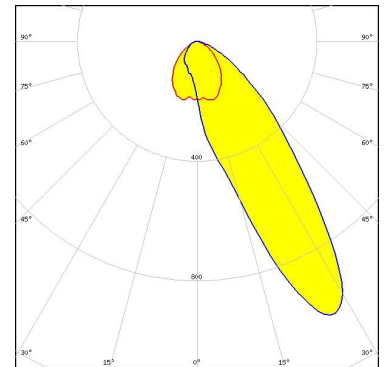

Light distribution files



LED CHA0410  
Ordering code CP19128\_AMY-50-WAS-C2  
FWHM / FWTM Asymmetric  
Efficiency 84 %  
Peak intensity 1.3 cd/lm  
LEDs/each optic 1  
Light colour/type White  
Required components:  
F17435\_HEKLA-G2-C

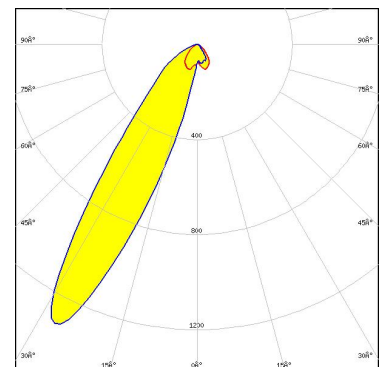

Light distribution files

### OPTICAL RESULTS (SIMULATED):



LED CHA0612  
Ordering code CP19128\_AMY-50-WAS-C2  
FWHM / FWTM Asymmetric  
Efficiency 85 %  
Peak intensity 1.2 cd/lm  
LEDs/each optic 1  
Light colour/type White  
Required components:  
F17435\_HEKLA-G2-C

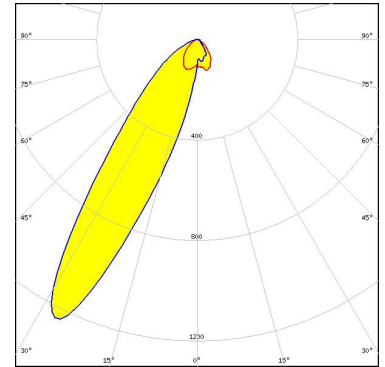

Light distribution files



LED CHA0825  
Ordering code CP19128\_AMY-50-WAS-C2  
FWHM / FWTM Asymmetric  
Efficiency 83 %  
Peak intensity 1.1 cd/lm  
LEDs/each optic 1  
Light colour/type White  
Required components:  
F17438\_HEKLA-G2-I

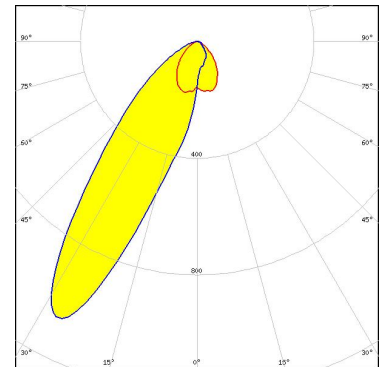

Light distribution files



LED CMB15xx  
Ordering code CP19128\_AMY-50-WAS-C2  
FWHM / FWTM Asymmetric  
Efficiency 82 %  
Peak intensity 1 cd/lm  
LEDs/each optic 1  
Light colour/type White  
Required components:  
F17436\_HEKLA-G2-D

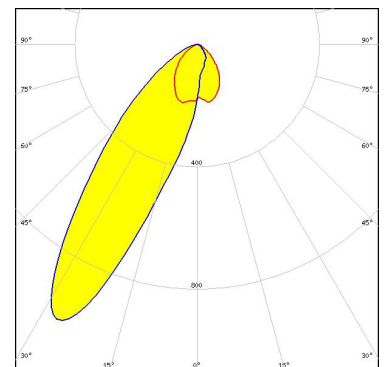

Light distribution files

### OPTICAL RESULTS (SIMULATED):



LED CMU10xx  
Ordering code CP19128\_AMY-50-WAS-C2  
FWHM / FWTM Asymmetric  
Efficiency 83 %  
Peak intensity 1 cd/lm  
LEDs/each optic 1  
Light colour/type White  
Required components:  
F17435\_HEKLA-G2-C

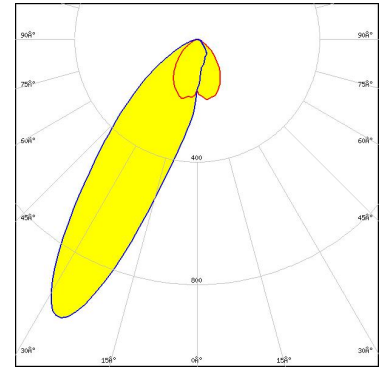

Light distribution files



LED CMU15xx  
Ordering code CP19128\_AMY-50-WAS-C2  
FWHM / FWTM Asymmetric  
Efficiency 81 %  
Peak intensity 0.8 cd/lm  
LEDs/each optic 1  
Light colour/type White  
Required components:  
F17438\_HEKLA-G2-I

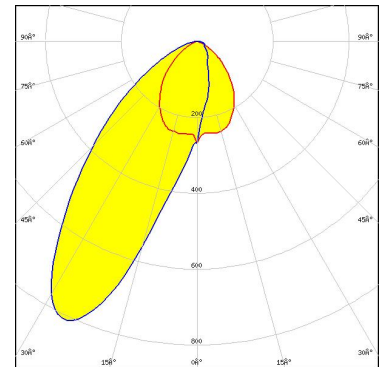

Light distribution files



LED CXA/B 13xx  
Ordering code CP19128\_AMY-50-WAS-C2  
FWHM / FWTM Asymmetric  
Efficiency 84 %  
Peak intensity 1.3 cd/lm  
LEDs/each optic 1  
Light colour/type White  
Required components:  
F17439\_HEKLA-G2-J

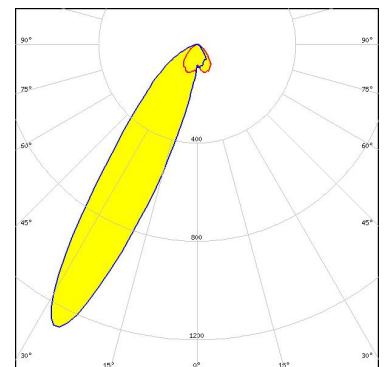

Light distribution files

### OPTICAL RESULTS (SIMULATED):



LED CXA/B 15xx  
 Ordering code CP19128\_AMY-50-WAS-C2  
 FWHM / FWTM Asymmetric  
 Efficiency 83 %  
 Peak intensity 1.1 cd/lm  
 LEDs/each optic 1  
 Light colour/type White  
 Required components:  
 F17436\_HEKLA-G2-D

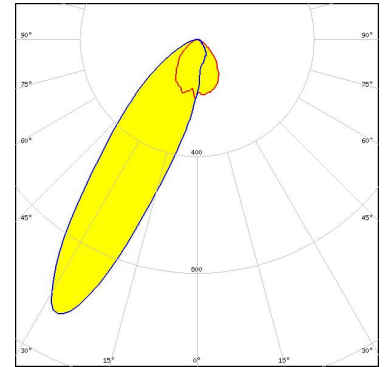

Light distribution files



LED LUXEON CX Plus CoB L08 (Gen2)  
 Ordering code CP19128\_AMY-50-WAS-C2  
 FWHM / FWTM Asymmetric  
 Efficiency 83 %  
 Peak intensity 0.8 cd/lm  
 LEDs/each optic 1  
 Light colour/type White  
 Required components:

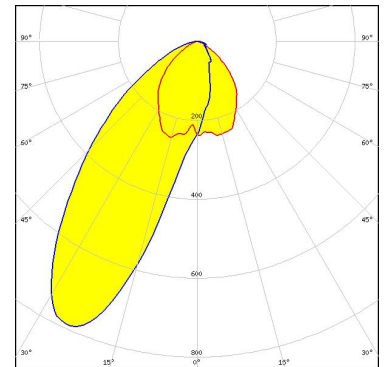

Bender Wirth: 637a Hekla

Light distribution files



LED LUXEON CX Plus CoB - HD S01H4  
 Ordering code CP19137\_AMY-50-WAS-B2  
 FWHM / FWTM Asymmetric  
 Efficiency 84 %  
 Peak intensity 1.3 cd/lm  
 LEDs/each optic 1  
 Light colour/type White  
 Required components:

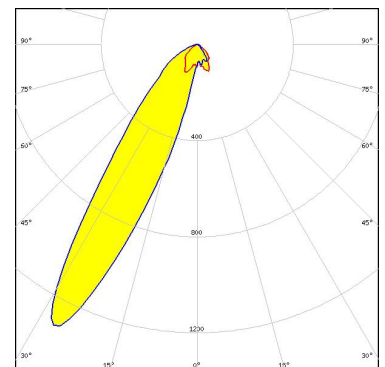

Bender Wirth: 634c Bayonet35L

Light distribution files

### OPTICAL RESULTS (SIMULATED):



**LED** LUXEON CX Plus CoB - HD S02H6  
**Ordering code** CP19137\_AMY-50-WAS-B2  
**FWHM / FWTM** Asymmetric  
**Efficiency** 84 %  
**Peak intensity** 1.2 cd/lm  
**LEDs/each optic** 1  
**Light colour/type** White  
**Required components:**

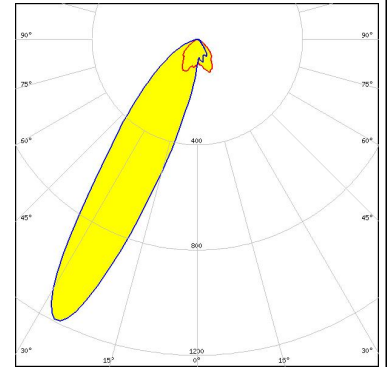

Bender Wirth: 634c Bayonet35L

[Light distribution files](#)



**LED** LUXEON CX Plus CoB - HD S04H9  
**Ordering code** CP19137\_AMY-50-WAS-B2  
**FWHM / FWTM** Asymmetric  
**Efficiency** 84 %  
**Peak intensity** 1 cd/lm  
**LEDs/each optic** 1  
**Light colour/type** White  
**Required components:**

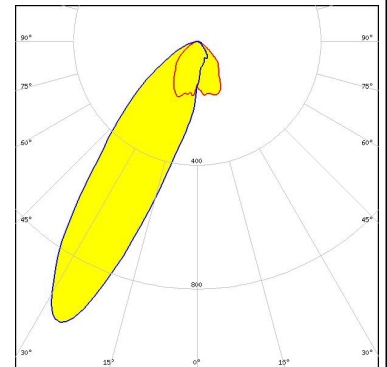

Bender Wirth: 634a Bayonet35L

[Light distribution files](#)



**LED** LUXEON CX Plus CoB L04 / L05 (Gen2)  
**Ordering code** CP19128\_AMY-50-WAS-C2  
**FWHM / FWTM** Asymmetric  
**Efficiency** 83 %  
**Peak intensity** 0.9 cd/lm  
**LEDs/each optic** 1  
**Light colour/type** White  
**Required components:**  
 F15254\_HEKLA-SOCKET-B

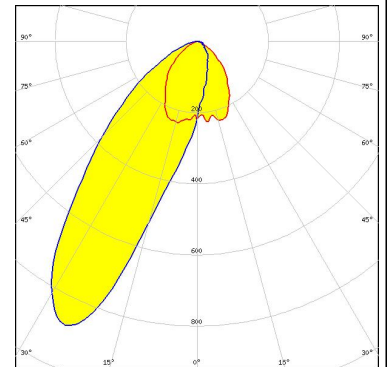

[Light distribution files](#)

### OPTICAL RESULTS (SIMULATED):



LED LUXEON CX Plus CoB M02 / M03 (Gen2)  
Ordering code CP19128\_AMY-50-WAS-C2  
FWHM / FWTM Asymmetric  
Efficiency 85 %  
Peak intensity 1 cd/lm  
LEDs/each optic 1  
Light colour/type White  
Required components:  
F15256\_HEKLA-SOCKET-D

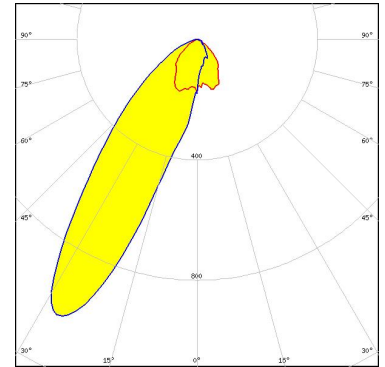

Light distribution files



LED LUXEON CX Plus CoB S01 (Gen2)  
Ordering code CP19128\_AMY-50-WAS-C2  
FWHM / FWTM Asymmetric  
Efficiency 86 %  
Peak intensity 1.2 cd/lm  
LEDs/each optic 1  
Light colour/type White  
Required components:  
F15956\_HEKLA-SOCKET-J

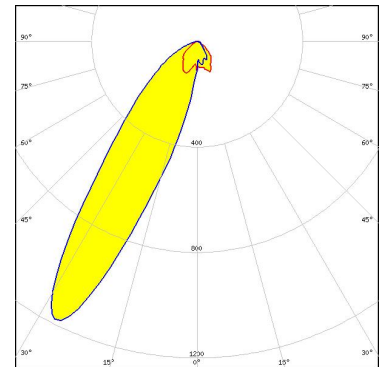

Light distribution files



LED CHM-9 XH (19x19)  
Ordering code CP19128\_AMY-50-WAS-C2  
FWHM / FWTM Asymmetric  
Efficiency 85 %  
Peak intensity 1.1 cd/lm  
LEDs/each optic 1  
Light colour/type White  
Required components:  
F15859\_HEKLA-SOCKET-I

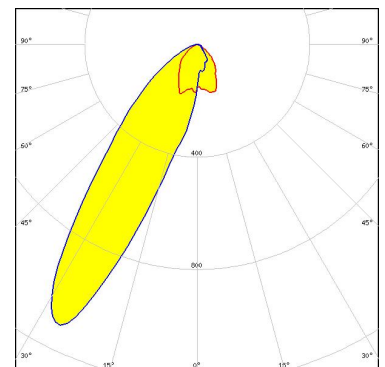

Light distribution files

### OPTICAL RESULTS (SIMULATED):



LED CTM-14 (Tunable White) Gen2  
Ordering code CP19128\_AMY-50-WAS-C2  
FWHM / FWTM Asymmetric  
Efficiency 83 %  
Peak intensity 0.8 cd/lm  
LEDs/each optic 1  
Light colour/type Tunable White  
Required components:  
C16142\_HEKLA-SOCKET-K

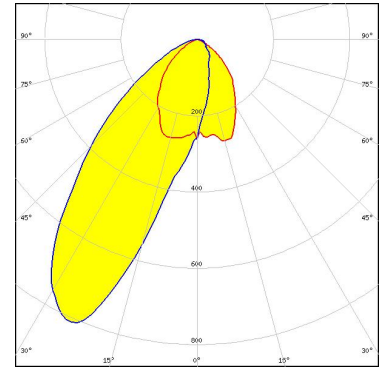

Light distribution files

Bender Wirth: 442 Typ L8



LED CTM-6 (Tunable White) Gen2  
Ordering code CP19128\_AMY-50-WAS-C2  
FWHM / FWTM Asymmetric  
Efficiency 85 %  
Peak intensity 1.2 cd/lm  
LEDs/each optic 1  
Light colour/type Tunable White  
Required components:  
C16142\_HEKLA-SOCKET-K

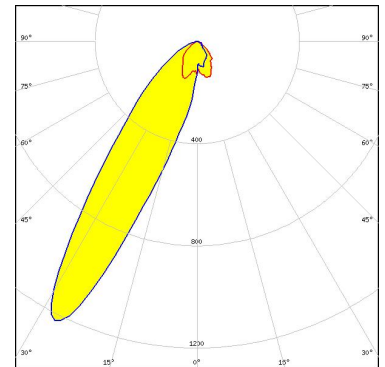

Light distribution files

Bender Wirth: 495 Typ L8



LED CTM-9 (Tunable White) Gen2  
Ordering code CP19128\_AMY-50-WAS-C2  
FWHM / FWTM Asymmetric  
Efficiency 84 %  
Peak intensity 1.1 cd/lm  
LEDs/each optic 1  
Light colour/type Tunable White  
Required components:  
C16142\_HEKLA-SOCKET-K

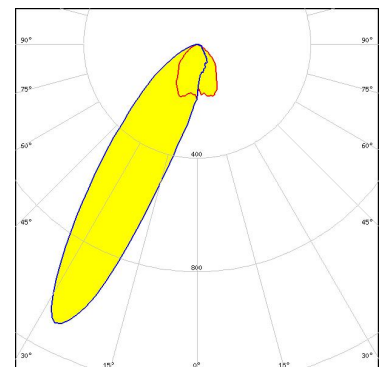

Light distribution files

Bender Wirth: 495 Typ L8

### OPTICAL RESULTS (SIMULATED):



LED CxM-6 (13.5x13.5)  
Ordering code CP19137\_AMY-50-WAS-B2  
FWHM / FWTM Asymmetric  
Efficiency 85 %  
Peak intensity 1.3 cd/lm  
LEDs/each optic 1  
Light colour/type White  
Required components:

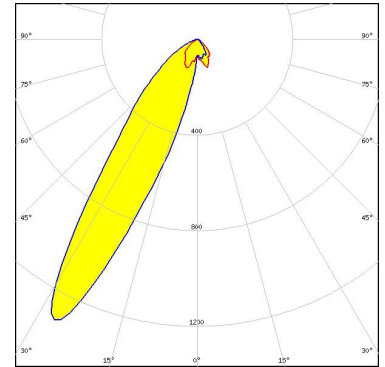

BJB: 47.360.1020

[Light distribution files](#)



LED CxM-9 (13.5x13.5)  
FWHM / FWTM Asymmetric  
Efficiency 73 %  
Peak intensity 2.2 cd/lm  
LEDs/each optic 1  
Light colour/type White  
Required components:  
C18968\_SOCKET-B-35-C

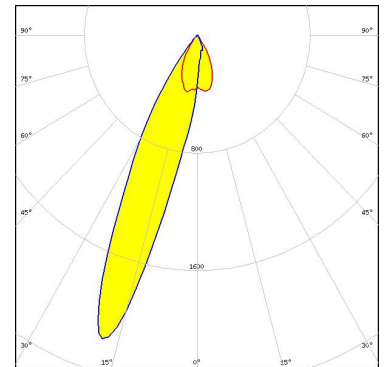

[Light distribution files](#)



LED COB J-Type  
Ordering code CP19128\_AMY-50-WAS-C2  
FWHM / FWTM Asymmetric  
Efficiency 82 %  
Peak intensity 0.8 cd/lm  
LEDs/each optic 1  
Light colour/type White  
Required components:

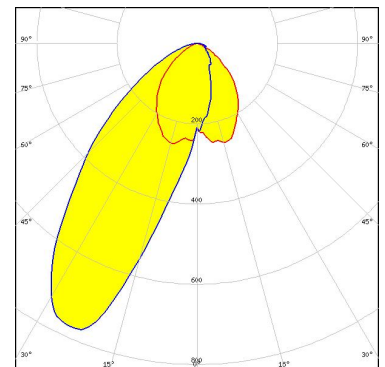

Bender Wirth: 663a Hekla XL

[Light distribution files](#)

### OPTICAL RESULTS (SIMULATED):



**LED** COB L-Type (LES 11)  
**Ordering code** CP19128\_AMY-50-WAS-C2  
**FWHM / FWTM** Asymmetric  
**Efficiency** 83 %  
**Peak intensity** 0.9 cd/lm  
**LEDs/each optic** 1  
**Light colour/type** White  
**Required components:**  
 F15858\_HEKLA-SOCKET-H

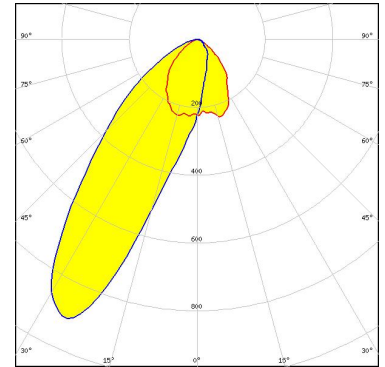

Light distribution files



**LED** COB L-Type (LES 9)  
**FWHM / FWTM** Asymmetric  
**Efficiency** 84 %  
**Peak intensity** 1 cd/lm  
**LEDs/each optic** 1  
**Light colour/type** White  
**Required components:**  
 F15858\_HEKLA-SOCKET-H

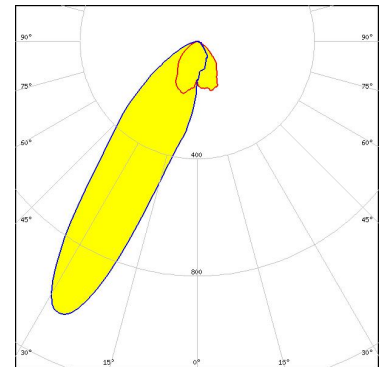

Light distribution files



**LED** COB S-Type (LES 6)  
**Ordering code** CP19137\_AMY-50-WAS-B2  
**FWHM / FWTM** Asymmetric  
**Efficiency** 84 %  
**Peak intensity** 1.2 cd/lm  
**LEDs/each optic** 1  
**Light colour/type** White  
**Required components:**  
 Bender Wirth: 652a Bayonet35L

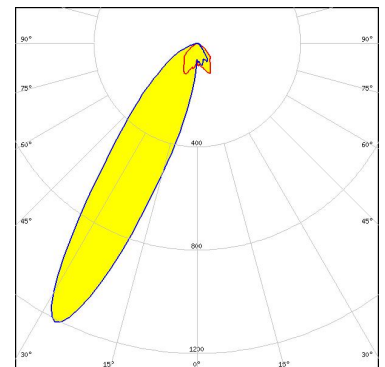

Light distribution files

### OPTICAL RESULTS (SIMULATED):

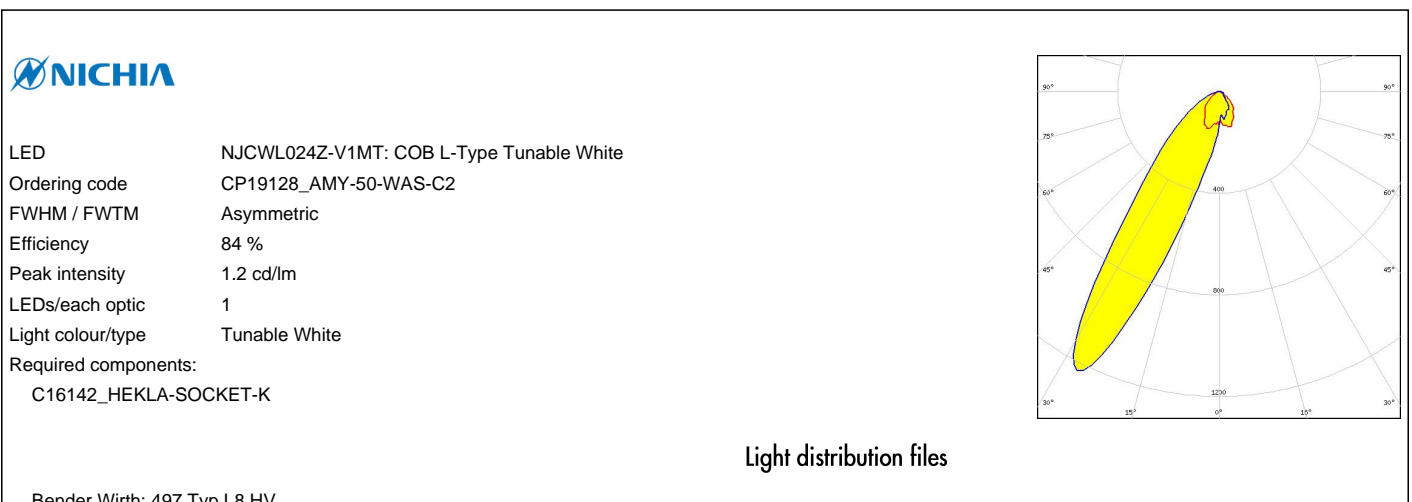
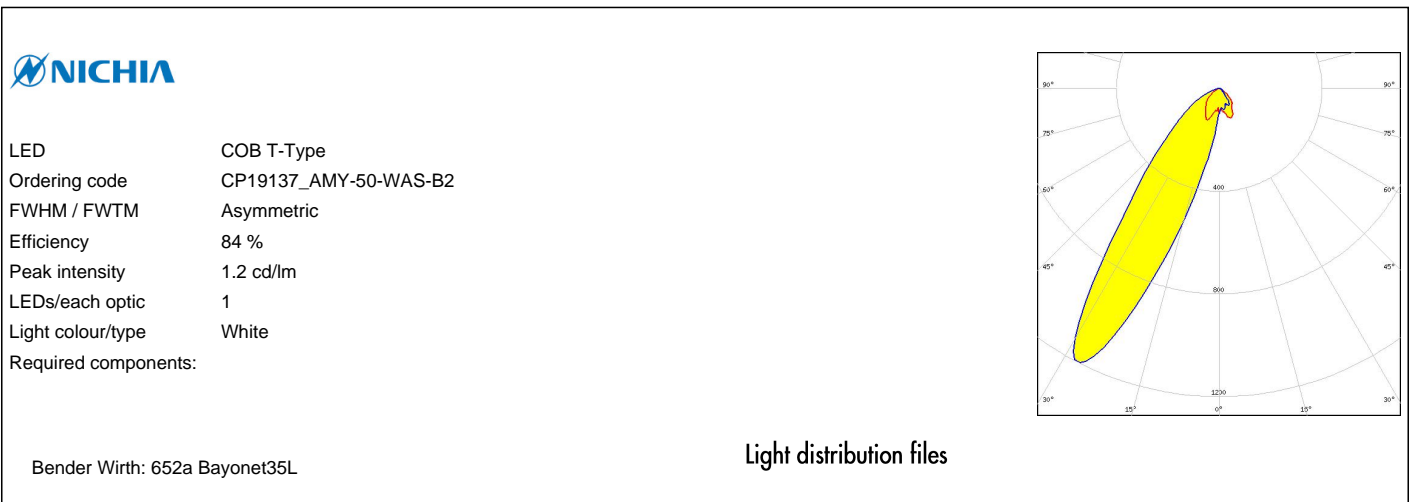

### OPTICAL RESULTS (SIMULATED):



LED NJNWS012Z-V1MT: COB S-Type Tunable White  
Ordering code CP19128\_AMY-50-WAS-C2  
FWHM / FWTM Asymmetric  
Efficiency 85 %  
Peak intensity 1.4 cd/lm  
LEDs/each optic 1  
Light colour/type Tunable White  
Required components:  
C16142\_HEKLA-SOCKET-K

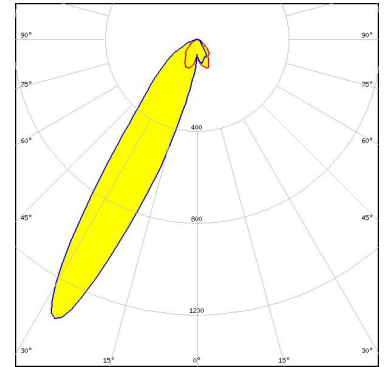

Light distribution files

Bender Wirth: 495 Typ L8 HV



LED NVCWJ024Z-V1MT: COB J-Type Tunable White  
Ordering code CP19128\_AMY-50-WAS-C2  
FWHM / FWTM Asymmetric  
Efficiency 83 %  
Peak intensity 1 cd/lm  
LEDs/each optic 1  
Light colour/type Tunable White  
Required components:  
C16142\_HEKLA-SOCKET-K

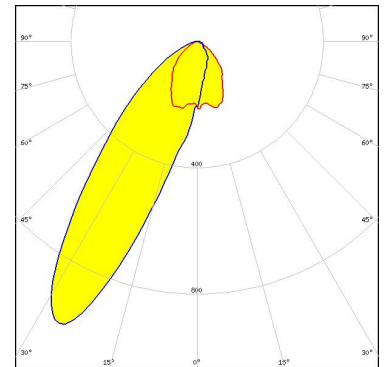

Light distribution files

Bender Wirth: 498 Typ L8 HV



LED LC003D / LC006D / LC009D / LC013D  
Ordering code C18441\_AMY-50-WAS  
FWHM / FWTM Asymmetric  
Efficiency 80 %  
Peak intensity 1 cd/lm  
LEDs/each optic 1  
Light colour/type White  
Required components:

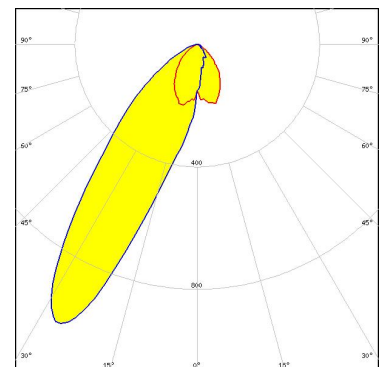

Light distribution files

### OPTICAL RESULTS (SIMULATED):

#### SAMSUNG

LED LC010C  
Ordering code CP19128\_AMY-50-WAS-C2  
FWHM / FWTM Asymmetric  
Efficiency 82 %  
Peak intensity 1.3 cd/lm  
LEDs/each optic 1  
Light colour/type White  
Required components:

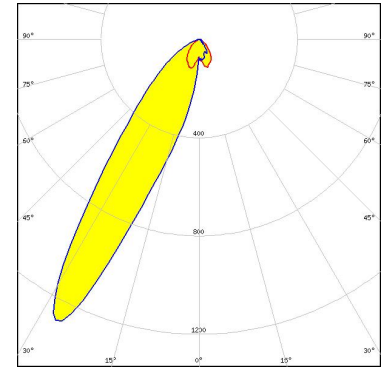

Light distribution files

#### SAMSUNG

LED LC010T (Tunable White)  
Ordering code CP19128\_AMY-50-WAS-C2  
FWHM / FWTM Asymmetric  
Efficiency 85 %  
Peak intensity 1.2 cd/lm  
LEDs/each optic 1  
Light colour/type Tunable White  
Required components:  
C16142\_HEKLA-SOCKET-K

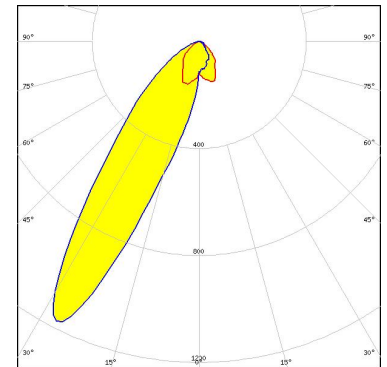

Light distribution files

Bender Wirth: 501 Typ L8

#### SAMSUNG

LED LC016D / LC019D / LC026D / LC033D  
Ordering code CP19137\_AMY-50-WAS-B2  
FWHM / FWTM Asymmetric  
Efficiency 80 %  
Peak intensity 0.8 cd/lm  
LEDs/each optic 1  
Light colour/type White  
Required components:

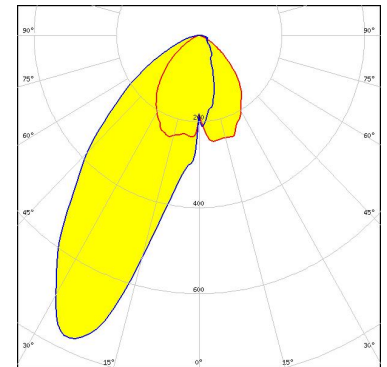

Light distribution files

BJB: 47.360.1010

### OPTICAL RESULTS (SIMULATED):

#### SAMSUNG

LED LC020C G2  
Ordering code CP19137\_AMY-50-WAS-B2  
FWHM / FWTM Asymmetric  
Efficiency 83 %  
Peak intensity 1.1 cd/lm  
LEDs/each optic 1  
Light colour/type White  
Required components:

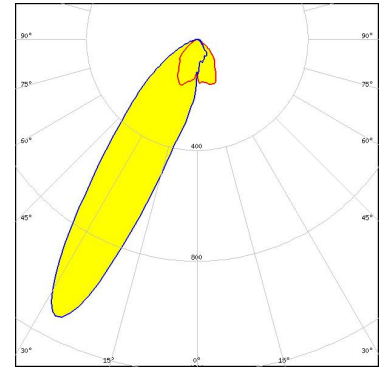

BJB: 47.360.1010

Light distribution files

#### SAMSUNG

LED LC030C/040C G2  
Ordering code CP19137\_AMY-50-WAS-B2  
FWHM / FWTM Asymmetric  
Efficiency 82 %  
Peak intensity 1 cd/lm  
LEDs/each optic 1  
Light colour/type White  
Required components:

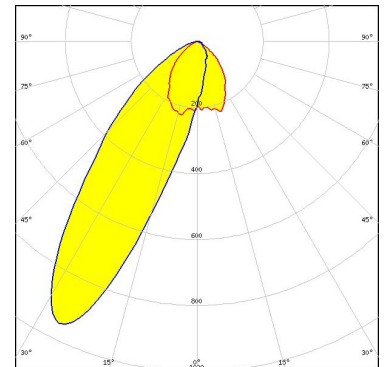

BJB: 47.360.1010

Light distribution files



LED MJT COB LES 14.5  
Ordering code CP19128\_AMY-50-WAS-C2  
FWHM / FWTM Asymmetric  
Efficiency 82 %  
Peak intensity 0.8 cd/lm  
LEDs/each optic 1  
Light colour/type White  
Required components:  
F15859\_HEKLA-SOCKET-I

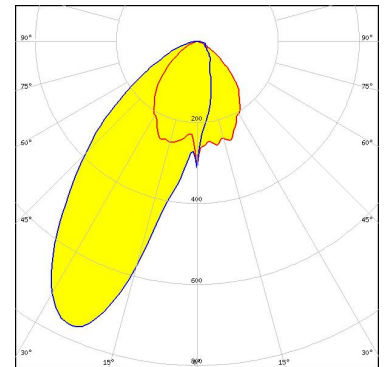

Light distribution files

### OPTICAL RESULTS (SIMULATED):

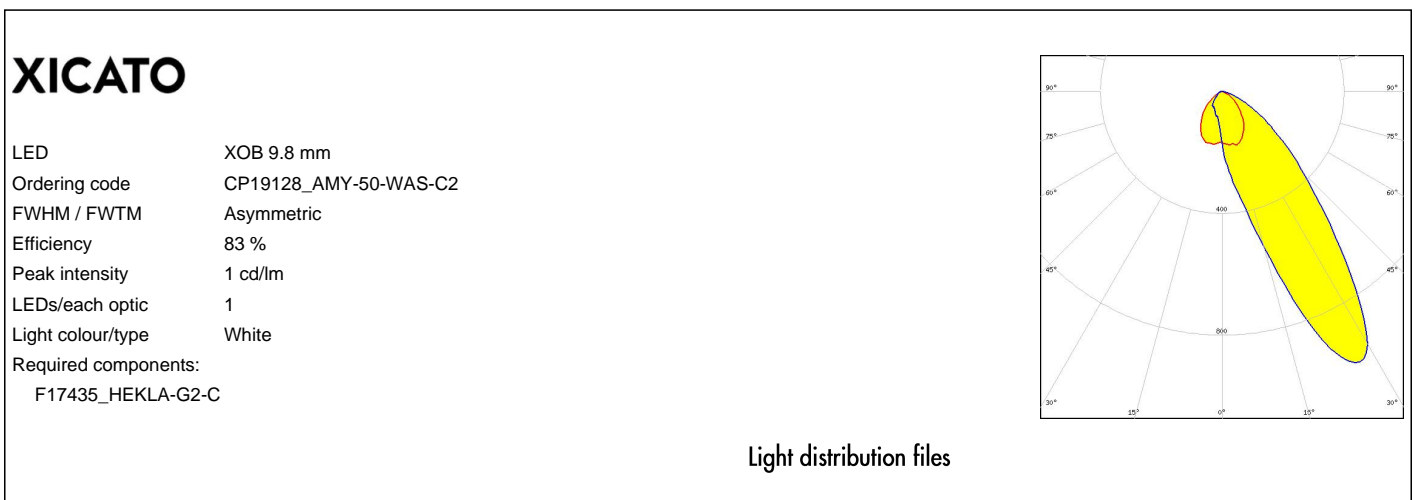
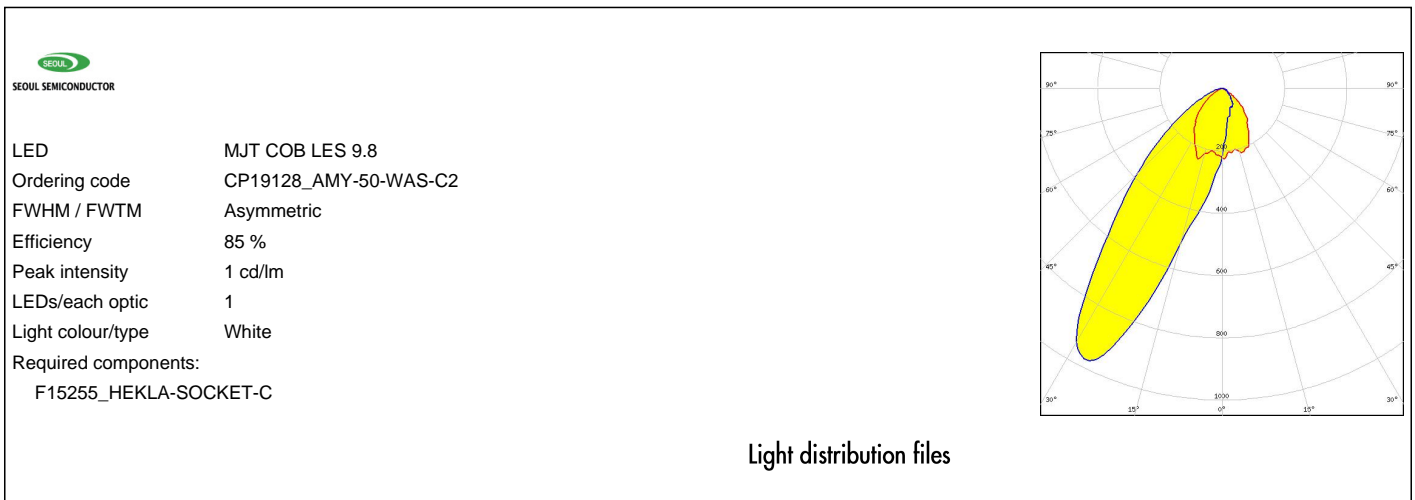
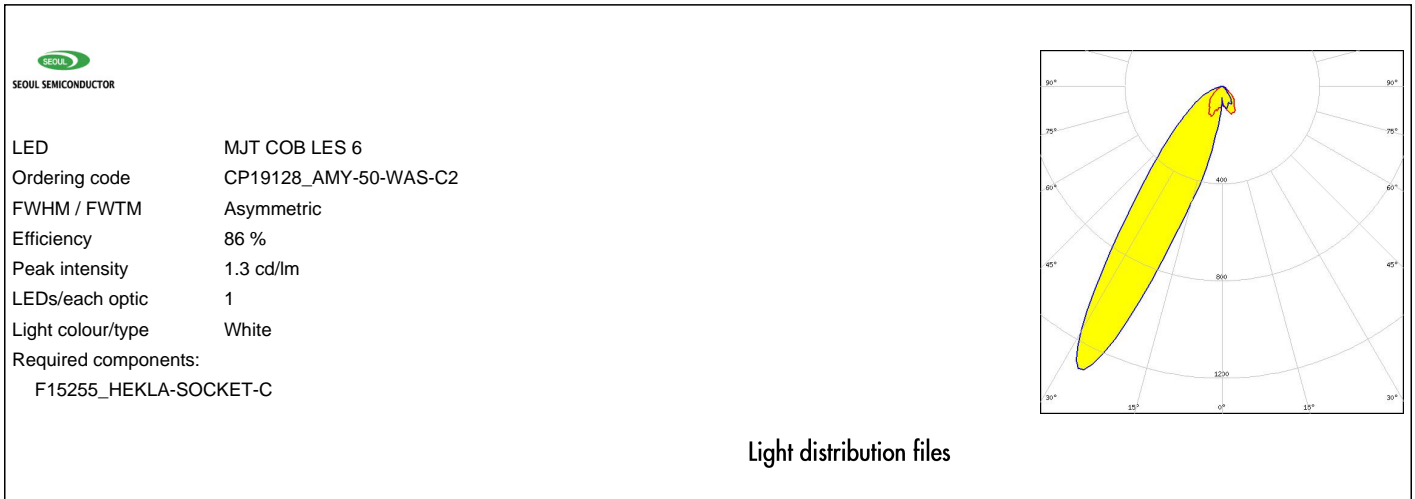

### GENERAL INFORMATION:

NOTE: The typical beam angle will be changed by different color, chip size and chip position tolerance. The typical total beam angle is the full angle measured where the luminous intensity is half of the peak value.

Due to use of high power COB's with this product, special attention to proper thermal design is highly recommended. LEDiL has no liability for direct, indirect or consecutive damages arising from the LEDiL products being used outside of the recommended temperature range.

### MATERIALS:

As part of our continuous research and improvement processes, and to ensure the best possible quality and availability of our products, LEDiL reserves the right to change material grades without notice.

### PRODUCT DATA USER AGREEMENT AND DISCLAIMER:

The measured data in the provided downloadable LEDiL Product Datasheets and Mechanical 2D-Drawings is rounded and provided as reference for planning. LEDiL Oy's optical specifications have been verified by conducting performance testing of the products in accordance with the company's quality system. The reported data are averaged results of multiple measurements with typical variation. LEDiL Oy reserves the right to without prior notification make changes and improvements to its products.

LEDiL Oy assumes neither warranty, nor guarantee nor any other liability of any kind for the contents and correctness of the provided data. The provided data has been generated with highest diligence but the provided data may in reality not represent the complete possible variation range of all intrinsic parameters. Therefore, in certain cases a deviation from the provided data could occur.

LEDiL Oy reserves the right to undertake technical changes of its products without further notification which could lead to changes in the provided data. LEDiL Oy assumes no liability of any kind for the possible deviation from any provided data or any other damage resulting from the usage of the provided data.

The user agrees to this disclaimer and user agreement with the download or usage of the provided files.

#### LEDiL Oy

Joensuunkatu 7  
FI-24100 SALO  
Finland

#### LEDiL Inc.

228 West Page Street  
Suite D  
Sycamore IL 60178  
USA

#### Ledil Optics Technology (Shenzhen) Co., Ltd.

# 405 , Block B  
Casic Motor Building  
Shenzhen 518057  
P.R.CHINA

#### Local sales and technical support

[www.ledil.com/  
where\\_to\\_buy](http://www.ledil.com/where_to_buy)

#### Shipping locations

Poznan, Poland  
Hong Kong, China

#### Distribution Partners

[www.ledil.com/  
where\\_to\\_buy](http://www.ledil.com/where_to_buy)