

Bipolar Transistor

(-)160 V, (-)1.5 A, Low $V_{CE(sat)}$,
(PNP)NPN Single TP/TP-FA

2SA1552, 2SC4027



IPAK/TP
CASE 369AJ

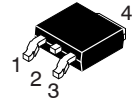

DPAK-3/TO-252-3
CASE 369AH

- 1: Base
- 2: Collector
- 3: Emitter
- 4: Collector

Features

- Adoption of FBET and MBIT Processes
- High Voltage and Large Current Capacity
- Ultrahigh-speed Switching
- Small and Slim Package Permitting 2SA1552 / 2SC4027-Applied Sets to be Made More Compact

Applications

- Converters, Inverters, Color TV Audio Output

Specifications

(): 2SA1552

ABSOLUTE MAXIMUM RATINGS (Ta = 25 °C)

Parameter	Symbol	Conditions	Ratings	Unit
Collector to Base Voltage	V_{CBO}		(-)180	V
Collector to Emitter Voltage	V_{CEO}		(-)160	V
Emitter to Base Voltage	V_{EBO}		(-)6	V
Collector Current	I_C		(-)1.5	A
Collector Current (Pulse)	I_{CP}		(-)2.5	A
Collector Dissipation	P_C		1	W
		$T_c = 25\text{ °C}$	15	
Junction Temperature	T_j		150	°C
Storage Temperature	T_{stg}		-55 to +150	°C

Stresses exceeding those listed in the Maximum Ratings table may damage the device. If any of these limits are exceeded, device functionality should not be assumed, damage may occur and reliability may be affected.

MARKING DIAGRAMS

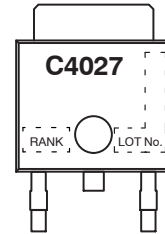
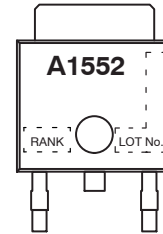

ELECTRICAL CONNECTION

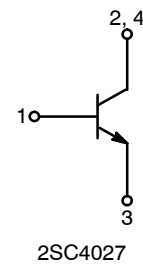
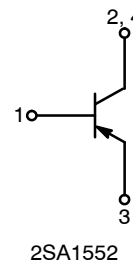

ORDERING INFORMATION

See detailed ordering, marking and shipping information on page 6 of this data sheet.

NOTE: Some of the devices on this data sheet have been **DISCONTINUED**. Please refer to the table on page 6.

2SA1552, 2SC4027

ELECTRICAL CHARACTERISTICS (Ta = 25 °C)

Parameter	Symbol	Conditions	Ratings			Unit
			Min	Typ	Max	
Collector Cutoff Current	I_{CBO}	$V_{CB} = (-)120 \text{ V}, I_E = 0 \text{ A}$	-	-	$(-)1.0$	μA
Emitter Cutoff Current	I_{EBO}	$V_{EB} = (-)4 \text{ V}, I_C = 0 \text{ A}$	-	-	$(-)1.0$	μA
DC Current Gain	h_{FE1}	$V_{CE} = (-)5 \text{ V}, I_C = (-)100 \text{ mA}$	140 (Note 1)	-	400 (Note 1)	
	h_{FE2}	$V_{CE} = (-)5 \text{ V}, I_C = (-)10 \text{ mA}$	80	-	-	
Gain-Bandwidth Product	f_T	$V_{CE} = (-)10 \text{ V}, I_C = (-)50 \text{ mA}$	-	120	-	MHz
Output Capacitance	C_{ob}	$V_{CB} = (-)10 \text{ V}, f = 1 \text{ MHz}$	-	(22)12	-	pF
Collector to Emitter Saturation Voltage	$V_{CE(sat)}$	$I_C = (-)500 \text{ mA}, I_B = (-)50 \text{ mA}$	-	$(-0.2)0.13$	$(-0.5)0.45$	V
Base to Emitter Saturation Voltage	$V_{BE(sat)}$	$I_C = (-)500 \text{ mA}, I_B = (-)50 \text{ mA}$		(-0.85)	(-1.2)	V
Collector to Base Breakdown Voltage	$V_{(BR)CBO}$	$I_C = (-)10 \mu\text{A}, I_E = 0 \text{ A}$	$(-)180$	-	-	V
Collector to Emitter Breakdown Voltage	$V_{(BR)CEO}$	$I_C = (-)1 \text{ mA}, R_{BE} = \infty$	$(-)160$	-	-	V
Emitter to Base Breakdown Voltage	$V_{(BR)EBO}$	$I_E = (-)10 \mu\text{A}, I_C = 0 \text{ A}$	$(-)6$	-	-	V
Turn-On Time	t_{on}	See specified Test Circuit	-	60	-	ns
Storage Time	t_{stg}		-	(0.7)1.2	-	μs
Fall Time	t_f		-	(50)80	-	ns

Product parametric performance is indicated in the Electrical Characteristics for the listed test conditions, unless otherwise noted. Product performance may not be indicated by the Electrical Characteristics if operated under different conditions.

1. The 2SA1552 / 2SC4027 are classified by 100 mA h_{FE} as follows: (unit: μA)

Rank	S	T
h_{FE}	140 to 280	200 to 400

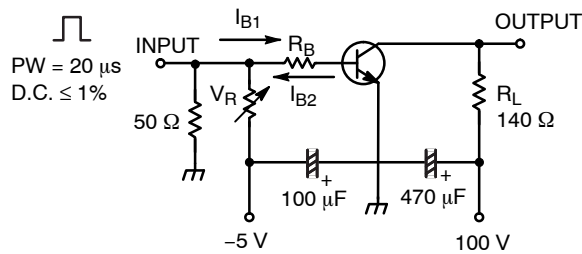

$10I_{B1} = -10I_{B2} = I_C = 0.7 \text{ A}$
For PNP, the polarity is reversed.

Figure 1. Switching Time Test Circuit

2SA1552, 2SC4027

TYPICAL CHARACTERISTICS

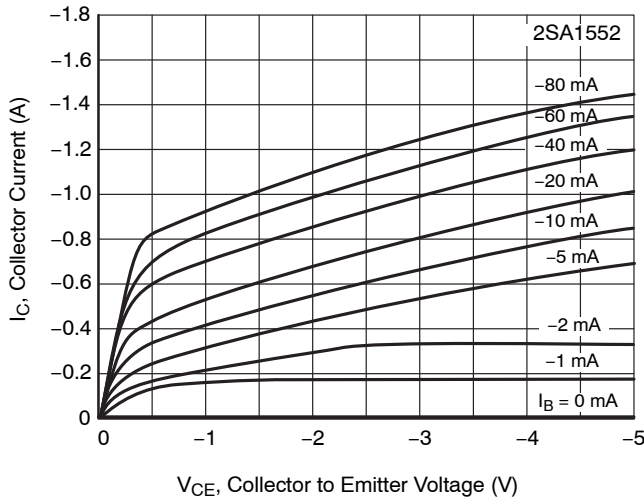

Figure 2. $I_C - V_{CE}$

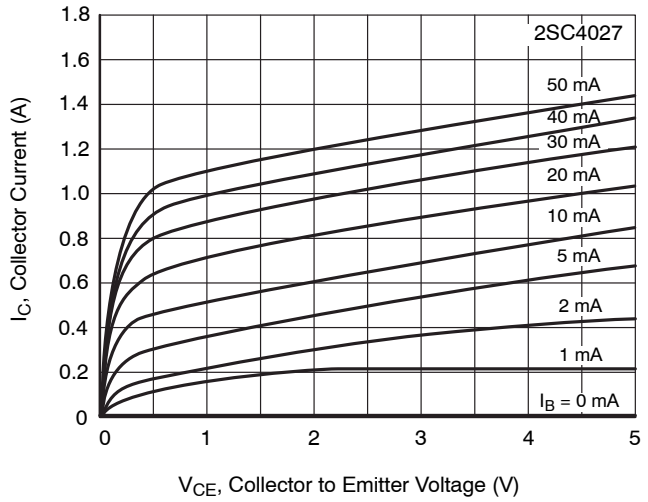

Figure 3. $I_C - V_{CE}$

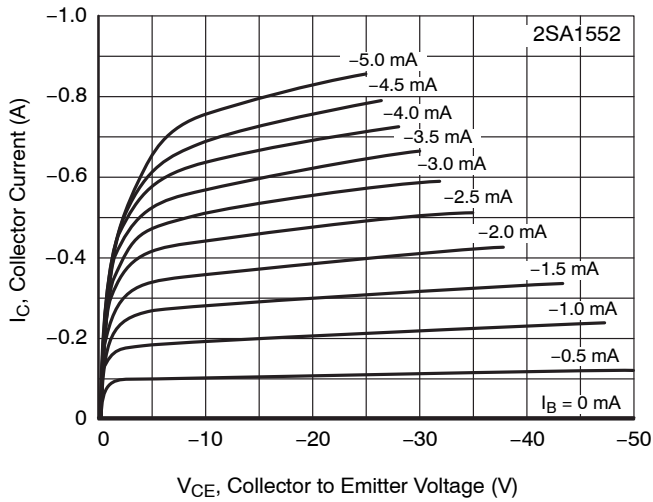

Figure 4. $I_C - V_{CE}$

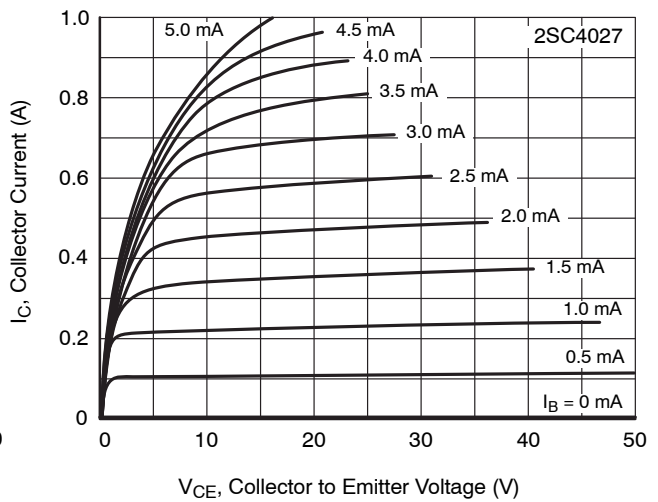

Figure 5. $I_C - V_{CE}$

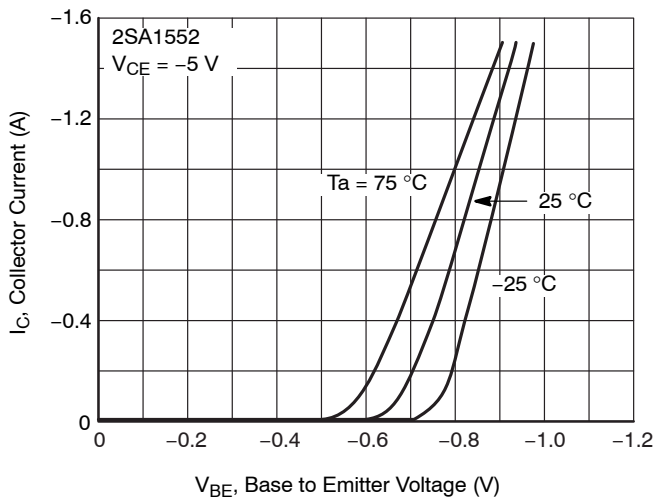

Figure 6. $I_C - V_{BE}$

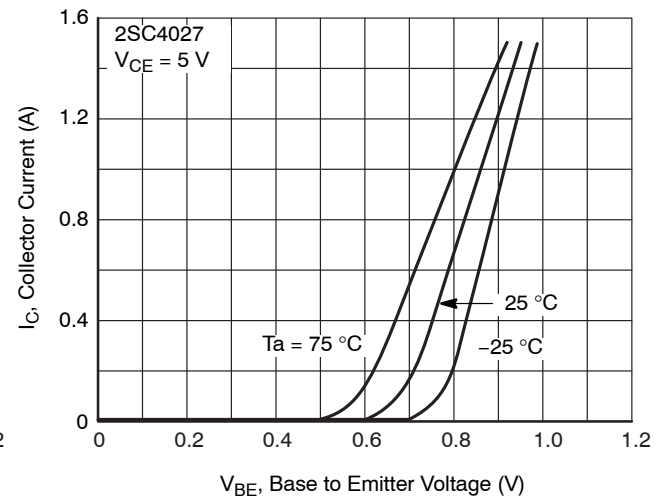

Figure 7. $I_C - V_{BE}$

2SA1552, 2SC4027

TYPICAL CHARACTERISTICS

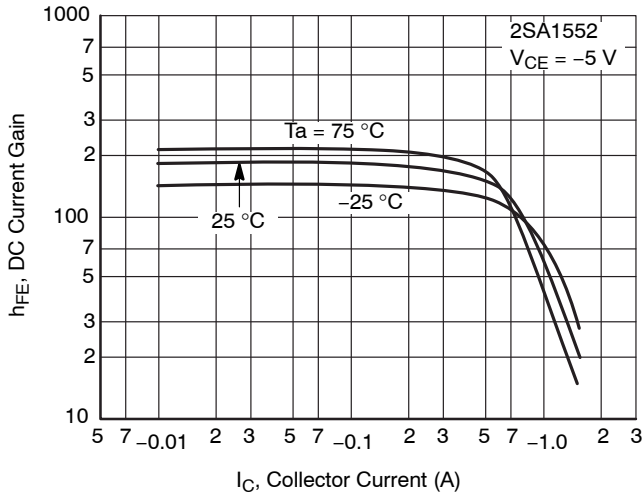

Figure 8. $h_{FE} - I_C$

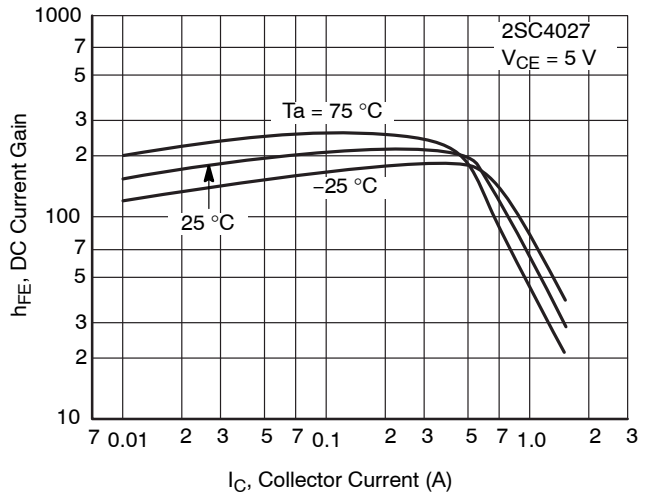

Figure 9. $h_{FE} - I_C$

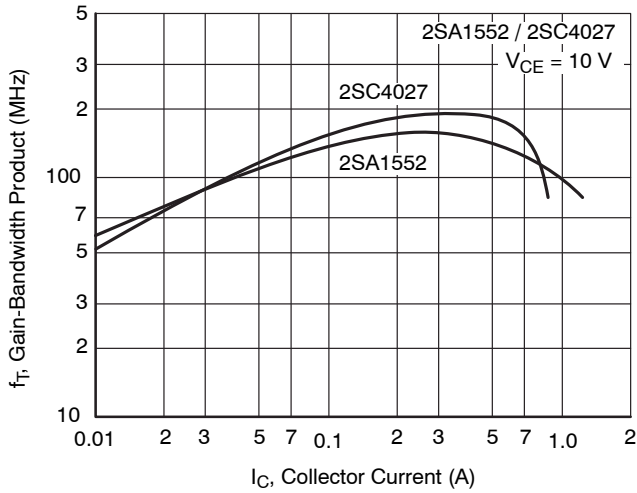

Figure 10. $f_T - I_C$

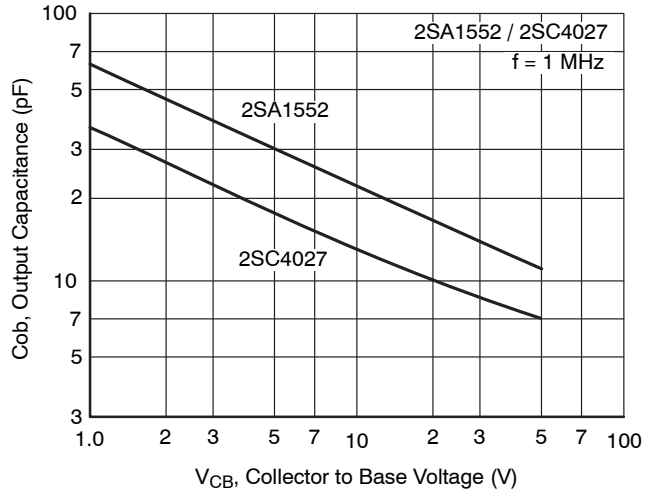

Figure 11. $C_{ob} - V_{CB}$

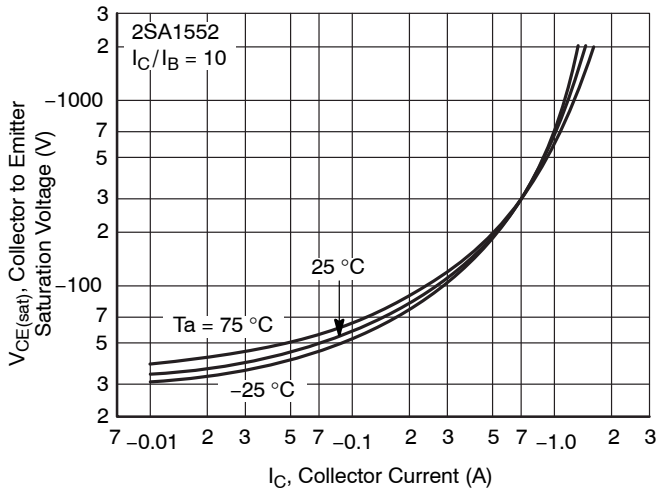

Figure 12. $V_{CE(sat)} - I_C$

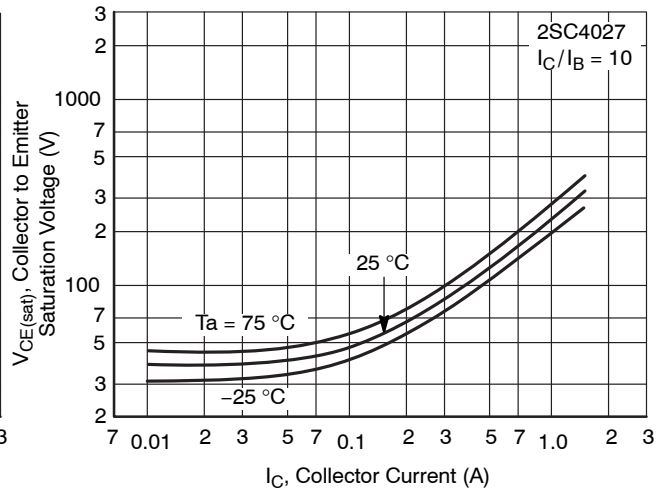

Figure 13. $V_{CE(sat)} - I_C$

2SA1552, 2SC4027

TYPICAL CHARACTERISTICS

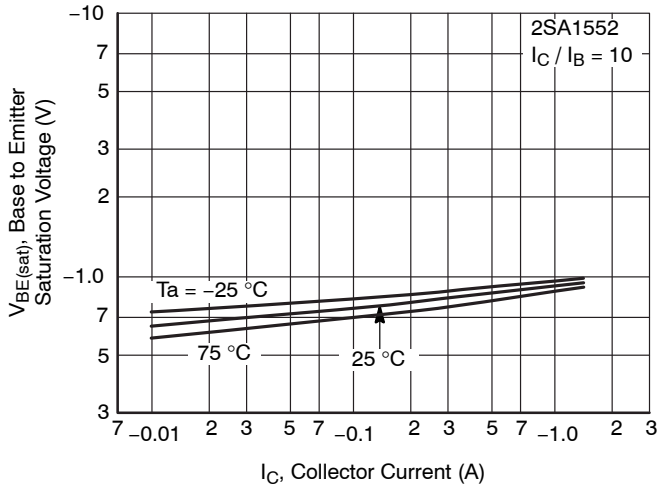

Figure 14. $V_{BE(sat)} - I_C$

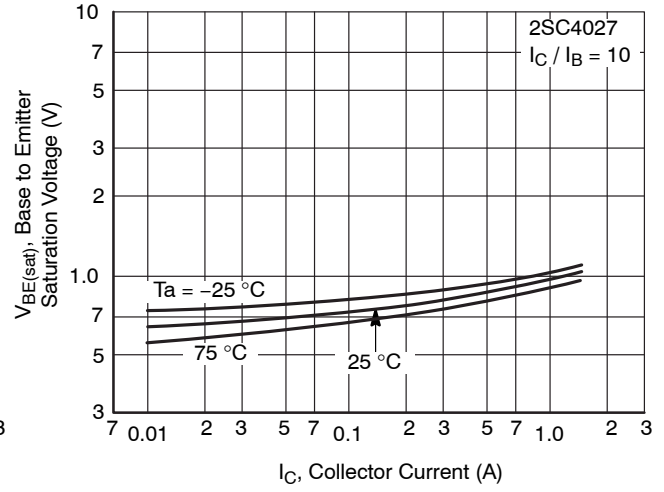

Figure 15. $V_{BE(sat)} - I_C$

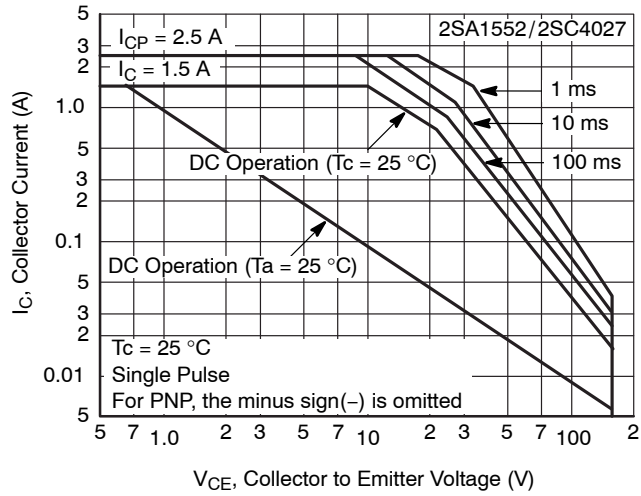

Figure 16. SOA

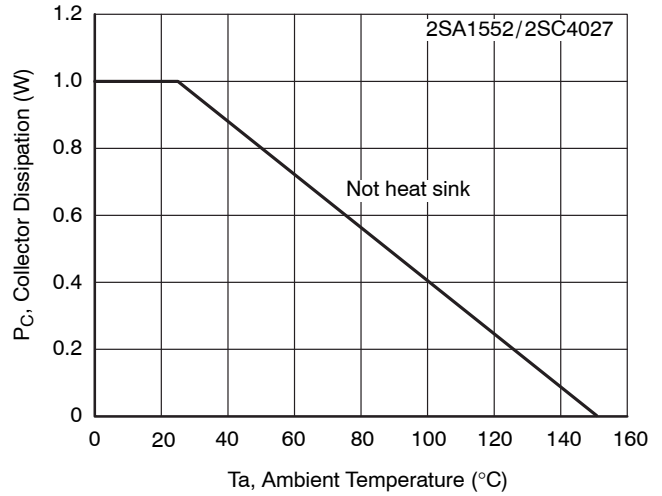

Figure 17. $P_C - T_a$

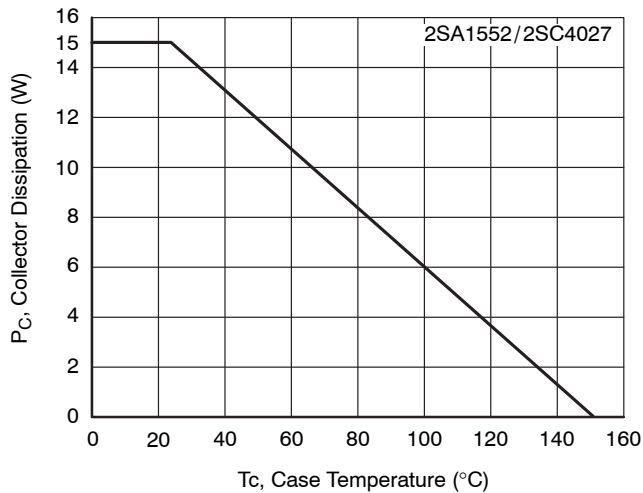

Figure 18. $P_C - T_c$

2SA1552, 2SC4027

ORDERING INFORMATION

Device	Package	Shipping†
2SA1552S-TL-E	DPAK-3 / TO-252-3 (Pb-Free)	700 / Tape & Reel
2SA1552S-TL-H	DPAK-3 / TO-252-3 (Pb-Free and Halogen Free)	700 / Tape & Reel
2SC4027S-TL-E	DPAK-3 / TO-252-3 (Pb-Free)	700 / Tape & Reel
2SC4027S-TL-H	DPAK-3 / TO-252-3 (Pb-Free and Halogen Free)	700 / Tape & Reel
2SC4027T-TL-E	DPAK-3 / TO-252-3 (Pb-Free)	700 / Tape & Reel

DISCONTINUED (Note 2)

2SA1552S-E	IPAK / TP (Pb-Free)	500 Units / Bulk
2SA1552S-H	IPAK / TP (Pb-Free and Halogen Free)	500 Units / Bulk
2SA1552T-E	IPAK / TP (Pb-Free)	500 Units / Bulk
2SA1552T-H	IPAK / TP (Pb-Free and Halogen Free)	500 Units / Bulk
2SC4027S-E	IPAK / TP (Pb-Free)	500 Units / Bulk
2SC4027S-H	IPAK / TP (Pb-Free and Halogen Free)	500 Units / Bulk
2SC4027T-E	IPAK / TP (Pb-Free)	500 Units / Bulk
2SC4027T-H	IPAK / TP (Pb-Free and Halogen Free)	500 Units / Bulk
2SA1552T-TL-E	DPAK-3 / TO-252-3 (Pb-Free)	700 / Tape & Reel
2SA1552T-TL-H	DPAK-3 / TO-252-3 (Pb-Free and Halogen Free)	700 / Tape & Reel
2SC4027T-TL-H	DPAK-3 / TO-252-3 (Pb-Free and Halogen Free)	700 / Tape & Reel

†For information on tape and reel specifications, including part orientation and tape sizes, please refer to our Tape and Reel Packaging Specifications Brochure, BRD8011/D.

2. **DISCONTINUED:** These devices are not recommended for new design. Please contact your **onsemi** representative for information. The most current information on these devices may be available on www.onsemi.com.

DPAK / TP-FA
CASE 369AH
ISSUE O

DATE 30 JAN 2012

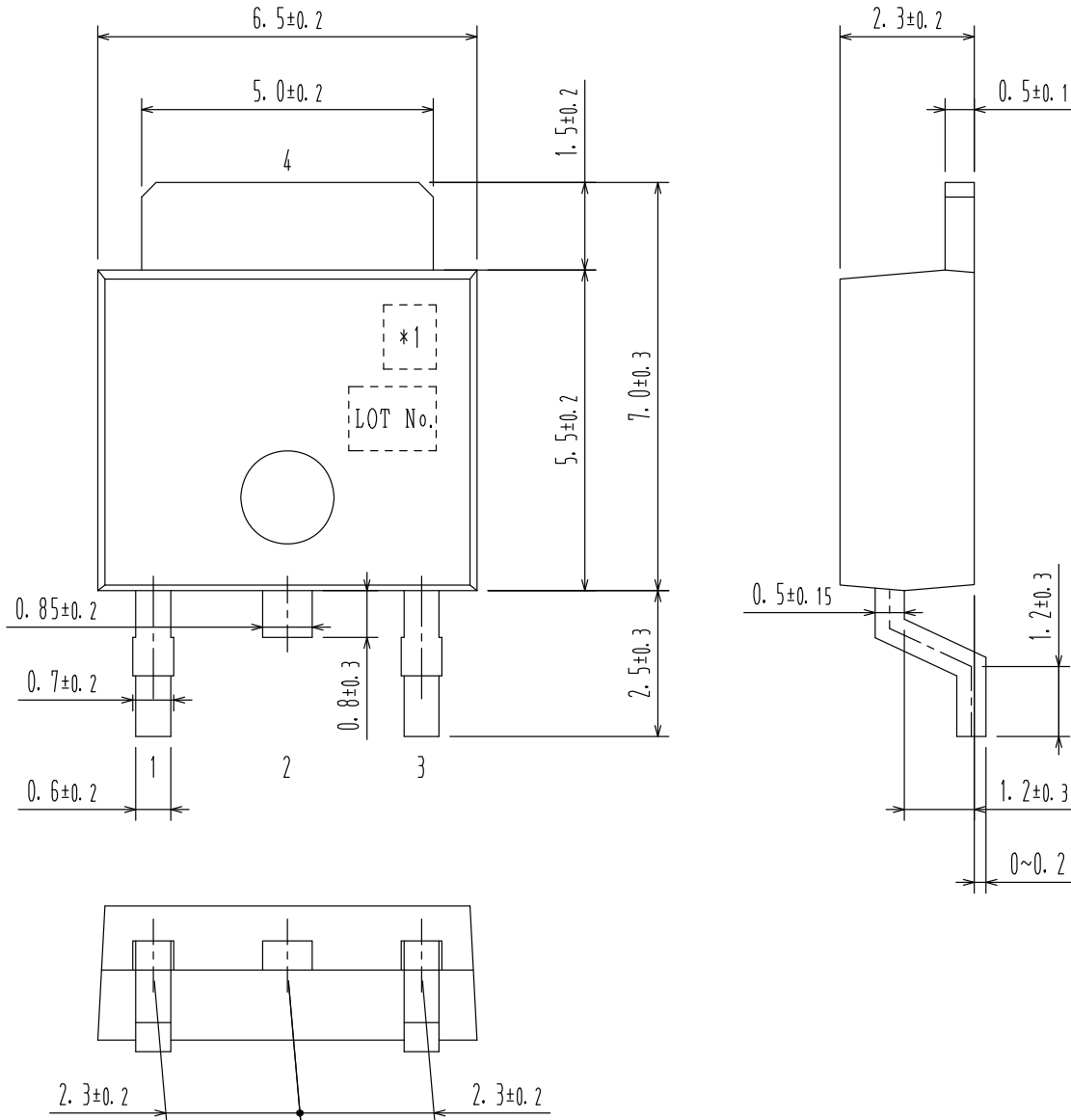

Pin 2 is idle pin with electrical designation only carried.

- 1:
- 2:
- 3:
- *1: Lot indication 4:

DOCUMENT NUMBER:	98AON66236E	Electronic versions are uncontrolled except when accessed directly from the Document Repository. Printed versions are uncontrolled except when stamped "CONTROLLED COPY" in red.
DESCRIPTION:	DPAK / TP-FA	PAGE 1 OF 1

onsemi and Onsemi are trademarks of Semiconductor Components Industries, LLC dba onsemi or its subsidiaries in the United States and/or other countries. onsemi reserves the right to make changes without further notice to any products herein. onsemi makes no warranty, representation or guarantee regarding the suitability of its products for any particular purpose, nor does onsemi assume any liability arising out of the application or use of any product or circuit, and specifically disclaims any and all liability, including without limitation special, consequential or incidental damages. onsemi does not convey any license under its patent rights nor the rights of others.

IPAK / TP
CASE 369AJ
ISSUE 0

DATE 30 JAN 2012

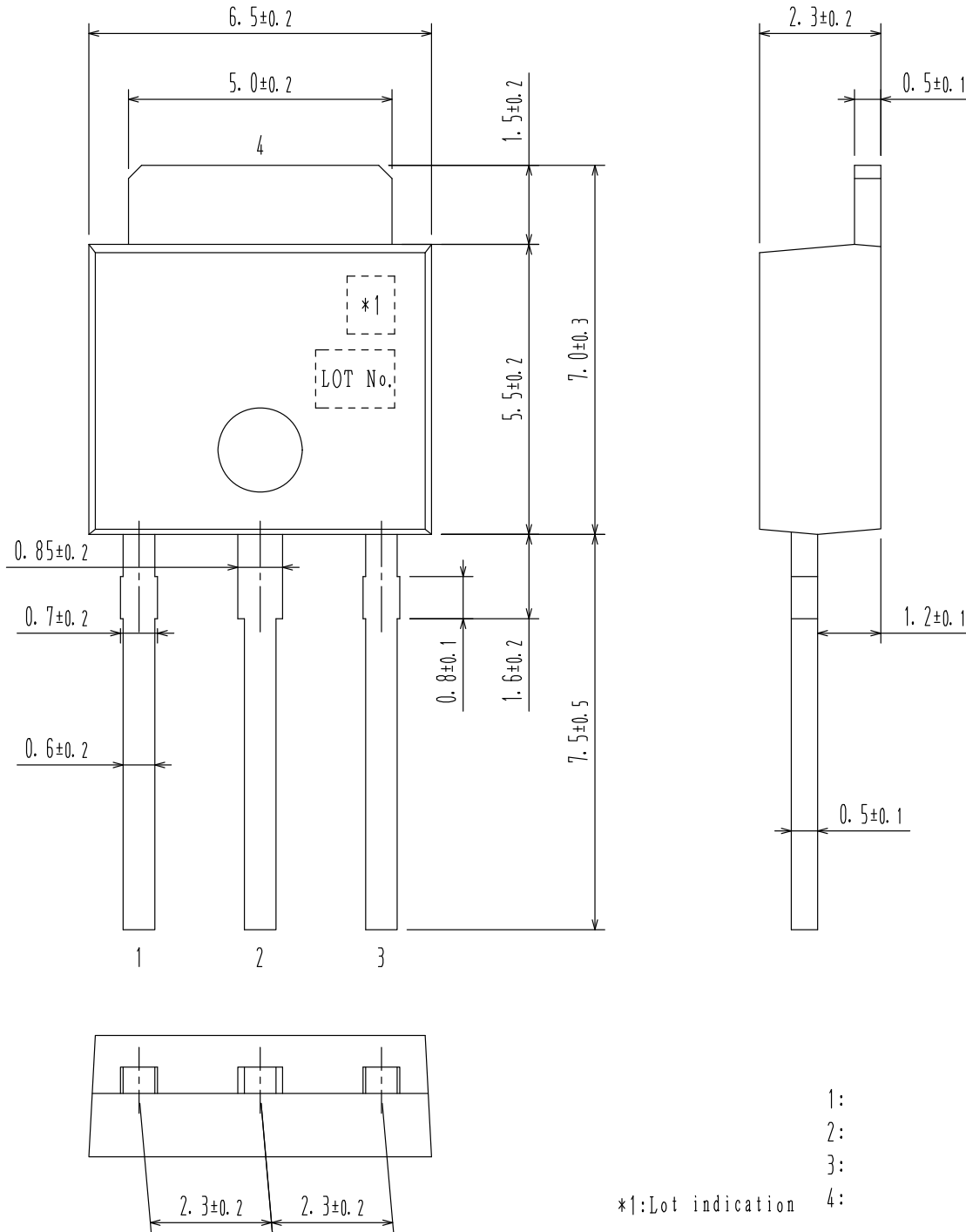

- 1:
- 2:
- 3:
- 4:

*1: Lot indication

DOCUMENT NUMBER:	98AON66237E	Electronic versions are uncontrolled except when accessed directly from the Document Repository. Printed versions are uncontrolled except when stamped "CONTROLLED COPY" in red.
DESCRIPTION:	IPAK / TP	PAGE 1 OF 1

onsemi and Onsemi are trademarks of Semiconductor Components Industries, LLC dba onsemi or its subsidiaries in the United States and/or other countries. onsemi reserves the right to make changes without further notice to any products herein. onsemi makes no warranty, representation or guarantee regarding the suitability of its products for any particular purpose, nor does onsemi assume any liability arising out of the application or use of any product or circuit, and specifically disclaims any and all liability, including without limitation special, consequential or incidental damages. onsemi does not convey any license under its patent rights nor the rights of others.

onsemi, **Onsemi**, and other names, marks, and brands are registered and/or common law trademarks of Semiconductor Components Industries, LLC dba "**onsemi**" or its affiliates and/or subsidiaries in the United States and/or other countries. **onsemi** owns the rights to a number of patents, trademarks, copyrights, trade secrets, and other intellectual property. A listing of **onsemi**'s product/patent coverage may be accessed at www.onsemi.com/site/pdf/Patent-Marking.pdf. **onsemi** reserves the right to make changes at any time to any products or information herein, without notice. The information herein is provided "as-is" and **onsemi** makes no warranty, representation or guarantee regarding the accuracy of the information, product features, availability, functionality, or suitability of its products for any particular purpose, nor does **onsemi** assume any liability arising out of the application or use of any product or circuit, and specifically disclaims any and all liability, including without limitation special, consequential or incidental damages. Buyer is responsible for its products and applications using **onsemi** products, including compliance with all laws, regulations and safety requirements or standards, regardless of any support or applications information provided by **onsemi**. "Typical" parameters which may be provided in **onsemi** data sheets and/or specifications can and do vary in different applications and actual performance may vary over time. All operating parameters, including "Typicals" must be validated for each customer application by customer's technical experts. **onsemi** does not convey any license under any of its intellectual property rights nor the rights of others. **onsemi** products are not designed, intended, or authorized for use as a critical component in life support systems or any FDA Class 3 medical devices or medical devices with a same or similar classification in a foreign jurisdiction or any devices intended for implantation in the human body. Should Buyer purchase or use **onsemi** products for any such unintended or unauthorized application, Buyer shall indemnify and hold **onsemi** and its officers, employees, subsidiaries, affiliates, and distributors harmless against all claims, costs, damages, and expenses, and reasonable attorney fees arising out of, directly or indirectly, any claim of personal injury or death associated with such unintended or unauthorized use, even if such claim alleges that **onsemi** was negligent regarding the design or manufacture of the part. **onsemi** is an Equal Opportunity/Affirmative Action Employer. This literature is subject to all applicable copyright laws and is not for resale in any manner.

ADDITIONAL INFORMATION

TECHNICAL PUBLICATIONS:

Technical Library: www.onsemi.com/design/resources/technical-documentation
onsemi Website: www.onsemi.com

ONLINE SUPPORT: www.onsemi.com/support

For additional information, please contact your local Sales Representative at www.onsemi.com/support/sales