

CSD87588N Synchronous Buck NexFET™ Power Block II

1 Features

- Half-Bridge Power Block
- 90% System Efficiency at 20 A
- Up to 25 A Operation
- High Density – 5 mm x 2.5 mm LGA Footprint
- Double Side Cooling Capability
- Ultra-Low Profile – 0.48 mm Max
- Optimized for 5 V Gate Drive
- Low Switching Losses
- Low Inductance Package
- RoHS Compliant
- Halogen Free
- Pb Free

2 Applications

- Synchronous Buck Converters
 - High-Current, Low Duty Cycle Applications
- Multiphase Synchronous Buck Converters
- POL DC-DC Converters

3 Description

The CSD87588N NexFET™ power block II is a highly-optimized design for synchronous buck applications offering high current and high efficiency capability in a small 5 mm x 2.5 mm outline. Optimized for 5 V gate drive applications, this product offers an efficient and flexible solution capable of providing a high density power supply when paired with any 5 V gate driver from an external controller/driver.

Ordering Information⁽¹⁾

Device	Media	Qty	Package	Ship
CSD87588N	13-Inch Reel	2500	5 x 2.5 LGA	Tape and Reel
CSD87588NT	7-Inch Reel	250		

(1) For all available packages, see the orderable addendum at the end of the data sheet.

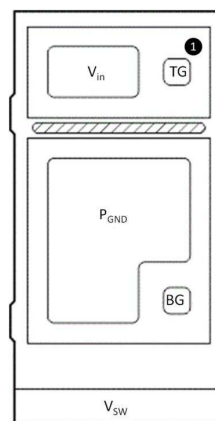

Typical Circuit

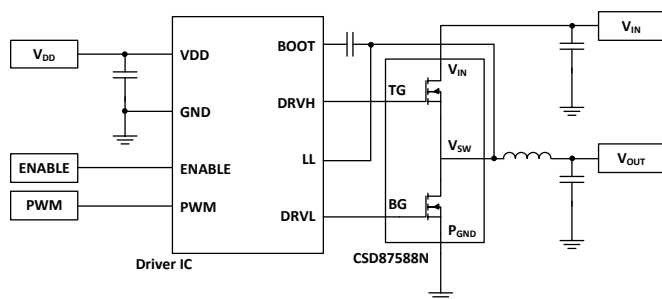

Typical Power Block Efficiency and Power Loss

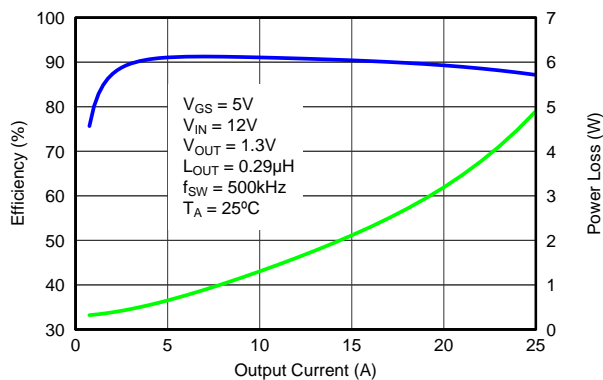

G001



Table of Contents

1 Features	1	7 Layout	13
2 Applications	1	7.1 Layout Guidelines	13
3 Description	1	7.2 Layout Example	13
4 Revision History	2	8 Device and Documentation Support	14
5 Specifications	3	8.1 Trademarks	14
5.1 Absolute Maximum Ratings	3	8.2 Electrostatic Discharge Caution	14
5.2 Recommended Operating Conditions	3	8.3 Glossary	14
5.3 Thermal Information	3	9 Mechanical, Packaging, and Orderable Information	15
5.4 Power Block Performance	4	9.1 CSD87588N Package Dimensions	15
5.5 Electrical Characteristics	4	9.2 Land Pattern Recommendation	16
5.6 Typical Power Block Device Characteristics	5	9.3 Stencil Recommendation (100 µm)	16
5.7 Typical Power Block MOSFET Characteristics	7	9.4 Stencil Recommendation (125 µm)	17
6 Application and Implementation	10	9.5 Pin Drawing	17
6.1 Application Information	10	9.6 CSD87588N Embossed Carrier Tape Dimensions	18

4 Revision History

NOTE: Page numbers for previous revisions may differ from page numbers in the current version.

Changes from Revision C (June 2014) to Revision D	Page
• Changed capacitance units to read pF in Figure 15	8
• Changed capacitance units to read pF in Figure 16	8

Changes from Revision B (January 2014) to Revision C	Page
• Changed "Pb-Free Terminal Plating" feature to state "Pb Free"	1

Changes from Revision A (May 2013) to Revision B	Page
• Added small reel info	1
• Updated Figure 5	5
• Updated Figure 6	5
• Updated Figure 7	5
• Updated Figure 8	5
• Changed figure reference to Figure 29 in electrical performance	13

Changes from Original (March 2013) to Revision A	Page
• Changed $R_{\theta JC-PCB}$ To: $R_{\theta JC}$ in the Thermal Information table	3

5 Specifications

5.1 Absolute Maximum Ratings

 $T_A = 25^\circ\text{C}$ (unless otherwise noted) ⁽¹⁾

		MIN	MAX	UNIT
Voltage	V_{IN} to P_{GND}	-0.8	30	V
	V_{SW} to P_{GND}		30	
	V_{SW} to P_{GND} (10 ns)		32	
	T_G to V_{SW}	-20	20	
	B_G to P_{GND}	-20	20	
I_{DM}	Pulsed Current Rating ⁽²⁾		50	A
P_D	Power Dissipation ⁽³⁾		6	W
E_{AS}	Avalanche Energy	Sync FET, $I_D = 45$, $L = 0.1$ mH	101	mJ
		Control FET, $I_D = 26$, $L = 0.1$ mH	34	
T_J	Operating Junction	-55	150	$^\circ\text{C}$
T_{stg}	Storage Temperature Range	-55	150	$^\circ\text{C}$

- (1) Stresses beyond those listed under *Absolute Maximum Ratings* may cause permanent damage to the device. These are stress ratings only, and functional operation of the device at these or any other conditions beyond those indicated is not implied. Exposure to absolute-maximum-rated conditions for extended periods may affect device reliability.
- (2) Pulse Duration ≤ 50 μs , duty cycle ≤ 0.01
- (3) Device mounted on FR4 material with 1 inch² (6.45 cm²) Cu

5.2 Recommended Operating Conditions

 $T_A = 25^\circ\text{C}$ (unless otherwise noted)

		MIN	MAX	UNIT	
V_{GS}	Gate Drive Voltage	4.5	16	V	
V_{IN}	Input Supply Voltage		24	V	
f_{SW}	Switching Frequency	$C_{BST} = 0.1$ μF (min)	200	1500	kHz
Operating Current	No Airflow		25	A	
	With Airflow (200 LFM)		30	A	
	With Airflow + Heat Sink		35	A	
T_J	Operating Temperature		125	$^\circ\text{C}$	

5.3 Thermal Information

 $T_A = 25^\circ\text{C}$ (unless otherwise stated)

THERMAL METRIC		MIN	TYP	MAX	UNIT
$R_{\theta JA}$	Junction-to-ambient thermal resistance (Min Cu) ⁽¹⁾			170	$^\circ\text{C}/\text{W}$
	Junction-to-ambient thermal resistance (Max Cu) ⁽²⁾ ⁽¹⁾			70	
$R_{\theta JC}$	Junction-to-case thermal resistance (Top of package) ⁽¹⁾			3.7	
	Junction-to-case thermal resistance (P_{GND} Pin) ⁽¹⁾			1.25	

- (1) $R_{\theta JC}$ is determined with the device mounted on a 1 inch² (6.45 cm²), 2 oz. (0.071 mm thick) Cu pad on a 1.5 inches \times 1.5 inches (3.81 cm \times 3.81 cm), 0.06 inch (1.52 mm) thick FR4 board. $R_{\theta JC}$ is specified by design while $R_{\theta JA}$ is determined by the user's board design.
- (2) Device mounted on FR4 material with 1 inch² (6.45 cm²) Cu.

5.4 Power Block Performance

 $T_A = 25^\circ\text{C}$ (unless otherwise noted)

PARAMETER		CONDITIONS	MIN	TYP	MAX	UNIT
P_{LOSS}	Power Loss ⁽¹⁾	$V_{\text{IN}} = 12\text{ V}$, $V_{\text{GS}} = 5\text{ V}$ $V_{\text{OUT}} = 1.3\text{ V}$, $I_{\text{OUT}} = 15\text{ A}$ $f_{\text{SW}} = 500\text{ kHz}$ $L_{\text{OUT}} = 0.29\text{ }\mu\text{H}$, $T_J = 25^\circ\text{C}$		2.1		W
I_{QVIN}	V_{IN} Quiescent Current	T_G to $T_{\text{GR}} = 0\text{ V}$ B_G to $P_{\text{GND}} = 0\text{ V}$		10		μA

(1) Measurement made with six 10 μF (TDK C3216X5R1C106KT or equivalent) ceramic capacitors placed across V_{IN} to P_{GND} pins and using a high current 5 V driver IC.

5.5 Electrical Characteristics

 $T_A = 25^\circ\text{C}$ (unless otherwise stated)

PARAMETER		TEST CONDITIONS	Q1 FET			Q2 FET			UNIT
			MIN	TYP	MAX	MIN	TYP	MAX	
STATIC CHARACTERISTICS									
BV_{DSS}	Drain-to-Source Voltage	$V_{\text{GS}} = 0\text{ V}$, $I_{\text{DS}} = 250\text{ }\mu\text{A}$	30			30			V
I_{DSS}	Drain-to-Source Leakage Current	$V_{\text{GS}} = 0\text{ V}$, $V_{\text{DS}} = 24\text{ V}$			1			1	μA
I_{GSS}	Gate-to-Source Leakage Current	$V_{\text{DS}} = 0\text{ V}$, $V_{\text{GS}} = 20$			100			100	nA
$V_{\text{GS(th)}}$	Gate-to-Source Threshold Voltage	$V_{\text{DS}} = V_{\text{GS}}$, $I_{\text{DS}} = 250\text{ }\mu\text{A}$	1.1		1.9	1.1		1.9	V
$R_{\text{DS(on)}}$	Drain-to-Source On Resistance	$V_{\text{GS}} = 4.5\text{ V}$, $I_{\text{DS}} = 15\text{ A}$		10.4	12.5		3.5	4.2	m Ω
		$V_{\text{GS}} = 10\text{ V}$, $I_{\text{DS}} = 15\text{ A}$		8	9.6		2.9	3.5	
g_{fs}	Transconductance	$V_{\text{DS}} = 10\text{ V}$, $I_{\text{DS}} = 15\text{ A}$		43			93		S
DYNAMIC CHARACTERISTICS									
C_{ISS}	Input Capacitance ⁽¹⁾	$V_{\text{GS}} = 0\text{ V}$, $V_{\text{DS}} = 15\text{ V}$, $f = 1\text{ MHz}$		566	736		2310	3000	pF
C_{OSS}	Output Capacitance ⁽¹⁾			341	444		682	887	
C_{RSS}	Reverse Transfer Capacitance ⁽¹⁾			10.3	13.4		62	80.4	
R_G	Series Gate Resistance ⁽¹⁾			1.2	2.4		1.1	2.2	
Q_g	Gate Charge Total (4.5 V) ⁽¹⁾	$V_{\text{DS}} = 15\text{ V}$, $I_{\text{DS}} = 15\text{ A}$		3.2	4.1		13.7	17.9	nC
Q_{gd}	Gate Charge - Gate-to-Drain			0.7			4.3		
Q_{gs}	Gate Charge - Gate-to-Source			1.4			4.3		
$Q_{\text{g(th)}}$	Gate Charge at V_{th}			0.8			2.8		
Q_{OSS}	Output Charge	$V_{\text{DD}} = 12\text{ V}$, $V_{\text{GS}} = 0\text{ V}$		7			18.6		nC
$t_{\text{d(on)}}$	Turn On Delay Time	$V_{\text{DS}} = 15\text{ V}$, $V_{\text{GS}} = 4.5\text{ V}$, $I_{\text{DS}} = 15\text{ A}$, $R_G = 2\text{ }\Omega$		7.3			12.1		ns
t_r	Rise Time			31.6			36.7		
$t_{\text{d(off)}}$	Turn Off Delay Time			10.2			20.1		
t_f	Fall Time			5.0			6.3		
DIODE CHARACTERISTICS									
V_{SD}	Diode Forward Voltage	$I_{\text{DS}} = 15\text{ A}$, $V_{\text{GS}} = 0\text{ V}$		0.85			0.78		V
Q_{rr}	Reverse Recovery Charge	$V_{\text{dd}} = 15\text{ V}$, $I_{\text{F}} = 15\text{ A}$, $di/dt = 300\text{ A}/\mu\text{s}$		12.5			26.7		nC
t_{rr}	Reverse Recovery Time			16			23		ns

(1) Specified by design

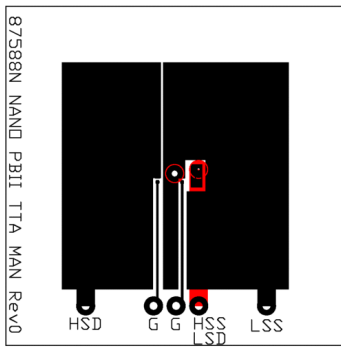

Max $R_{\theta JA} = 70^{\circ}\text{C/W}$ when mounted on 1 inch² (6.45 cm²) of 2 oz. (0.071 mm thick) Cu.

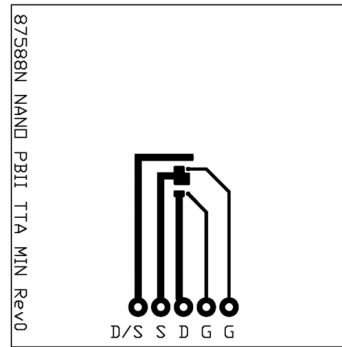

Max $R_{\theta JA} = 170^{\circ}\text{C/W}$ when mounted on minimum pad area of 2 oz. (0.071 mm thick) Cu.

5.6 Typical Power Block Device Characteristics

$T_J = 125^{\circ}\text{C}$, unless stated otherwise. The Typical Power Block System Characteristic curves [Figure 3](#) and [Figure 4](#) are based on measurements made on a PCB design with dimensions of 4.0 inches (W) × 3.5 inches (L) × 0.062 inch (H) and 6 copper layers of 1 oz. copper thickness. See [Application and Implementation](#) for detailed explanation.

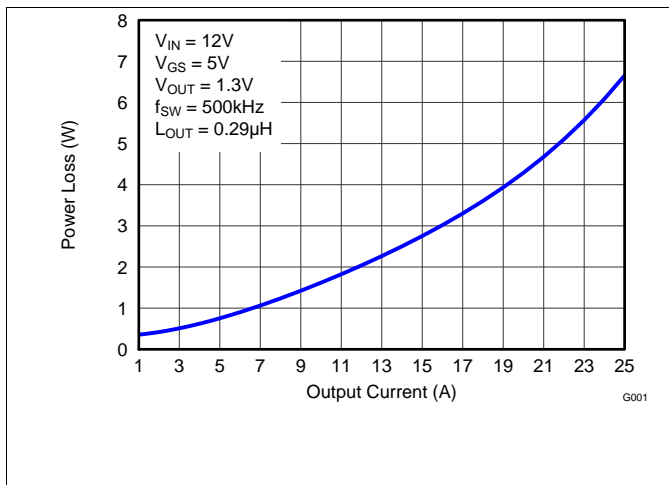

Figure 1. Power Loss vs Output Current

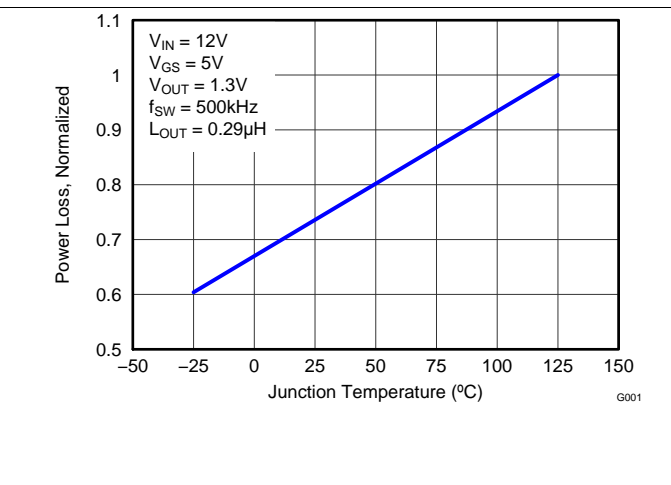

Figure 2. Normalized Power Loss vs Temperature

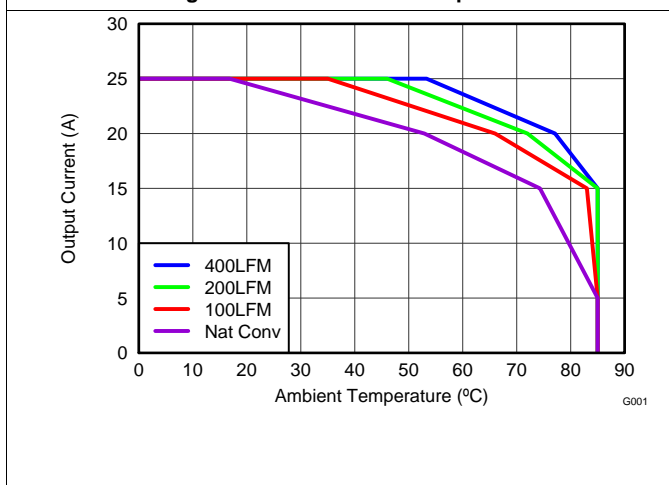

Figure 3. Safe Operating Area – PCB Horizontal Mount

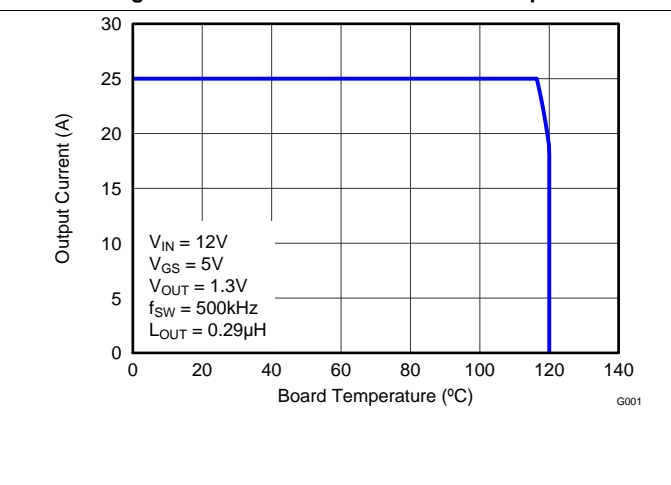

Figure 4. Typical Safe Operating Area

Typical Power Block Device Characteristics (continued)

$T_J = 125^\circ\text{C}$, unless stated otherwise. The Typical Power Block System Characteristic curves [Figure 3](#) and [Figure 4](#) are based on measurements made on a PCB design with dimensions of 4.0 inches (W) x 3.5 inches (L) x 0.062 inch (H) and 6 copper layers of 1 oz. copper thickness. See [Application and Implementation](#) for detailed explanation.

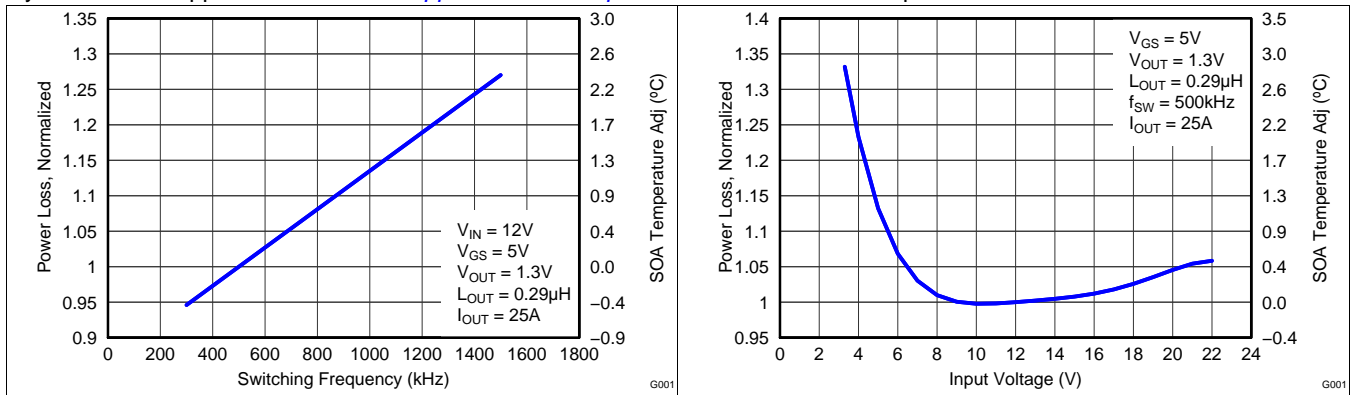

Figure 5. Normalized Power Loss vs Switching Frequency

Figure 6. Normalized Power Loss vs Input Voltage

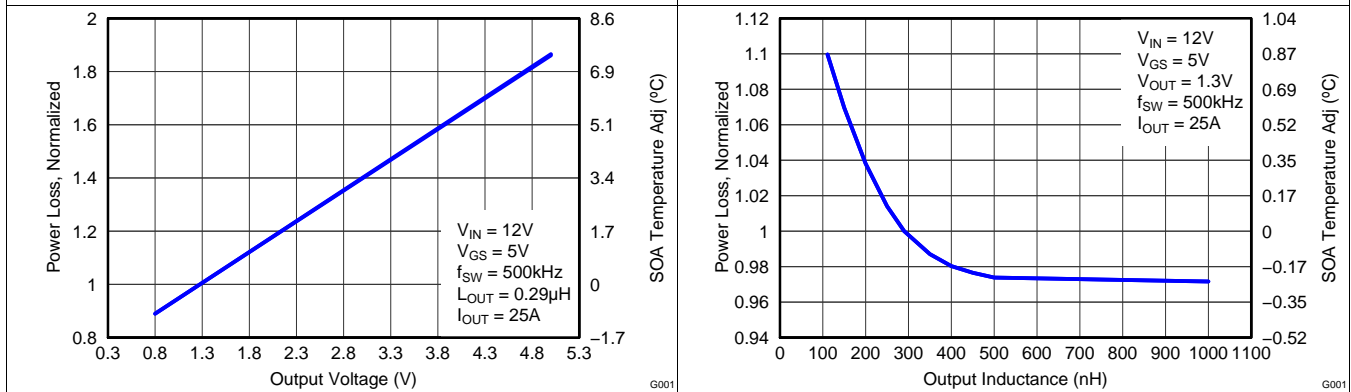
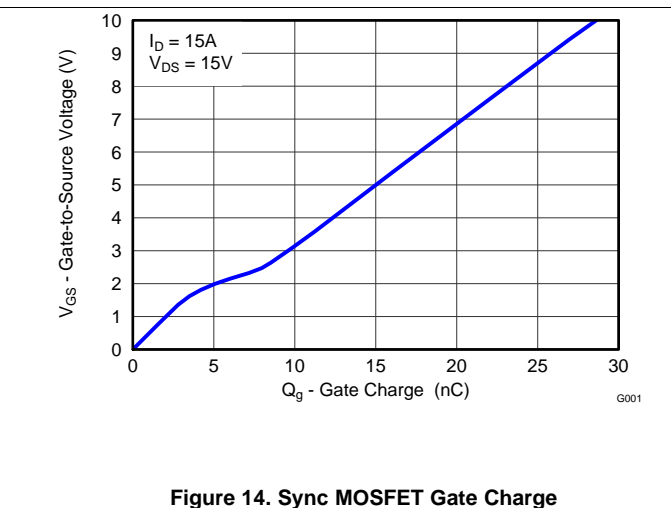
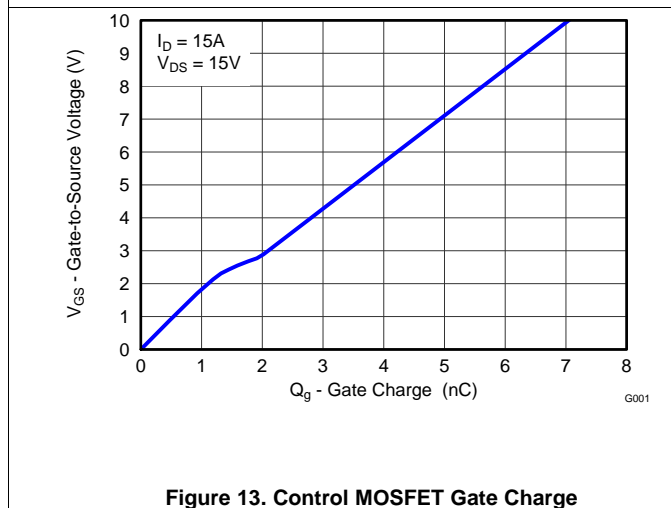
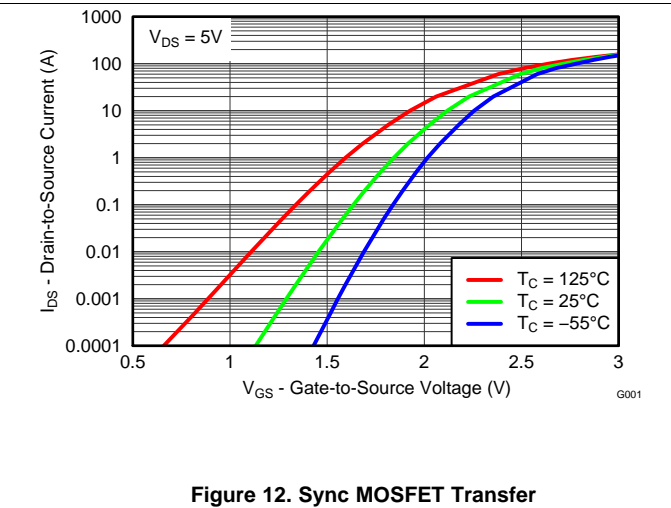
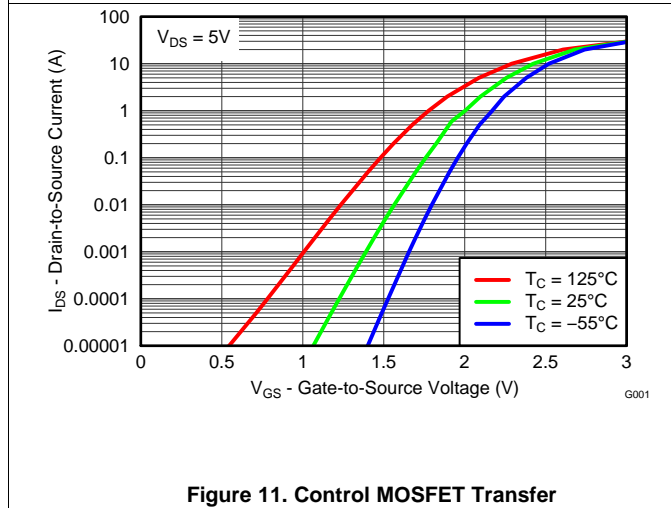
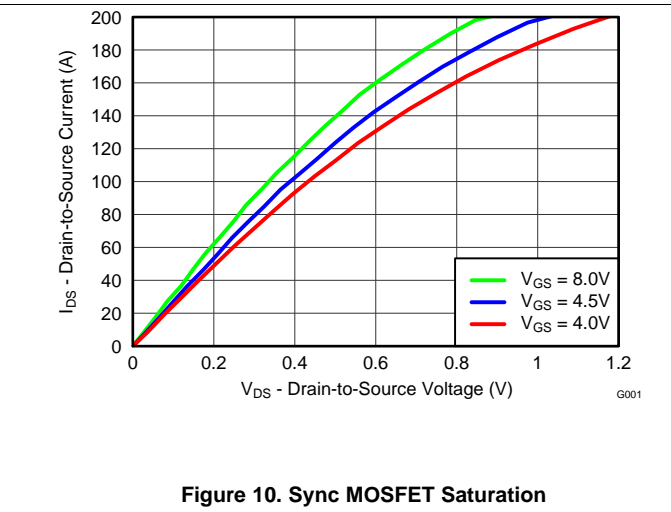
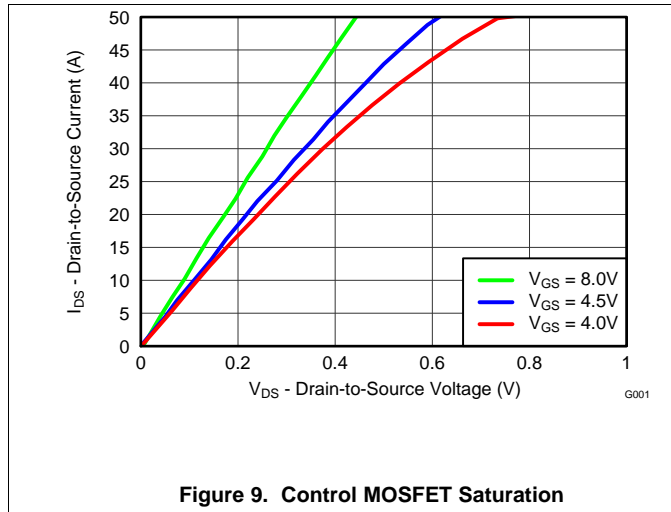

Figure 7. Normalized Power Loss vs Output Voltage

Figure 8. Normalized Power Loss vs Output Inductance

5.7 Typical Power Block MOSFET Characteristics

T_A = 25°C, unless stated otherwise.



Typical Power Block MOSFET Characteristics (continued)

T_A = 25°C, unless stated otherwise.

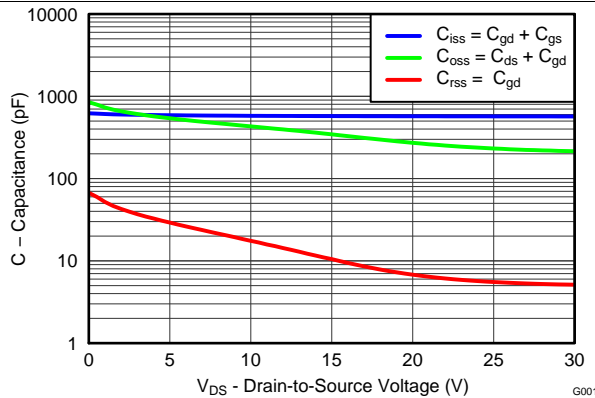

Figure 15. Control MOSFET Capacitance

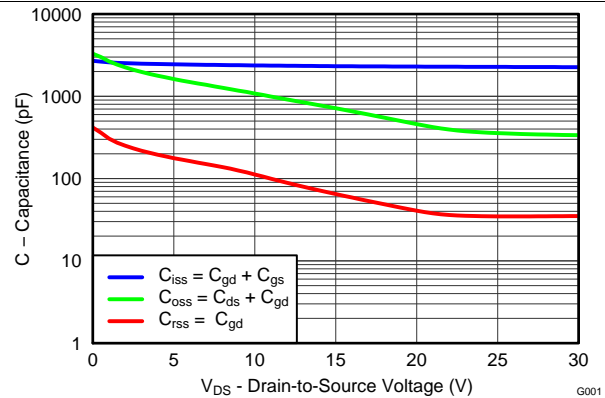

Figure 16. Sync MOSFET Capacitance

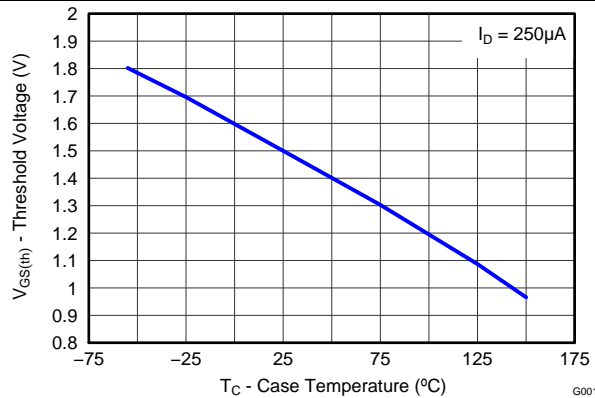

Figure 17. Control MOSFET V_{GS(th)}

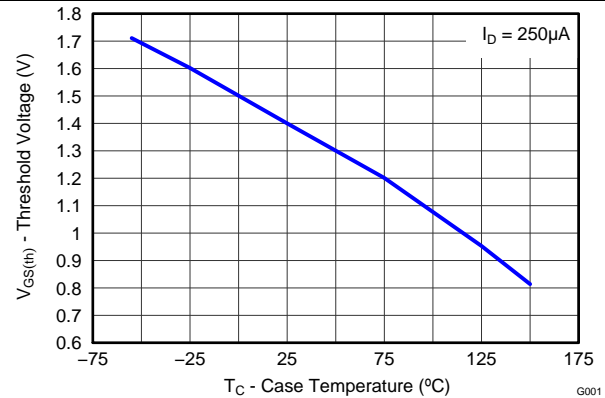

Figure 18. Sync MOSFET V_{GS(th)}

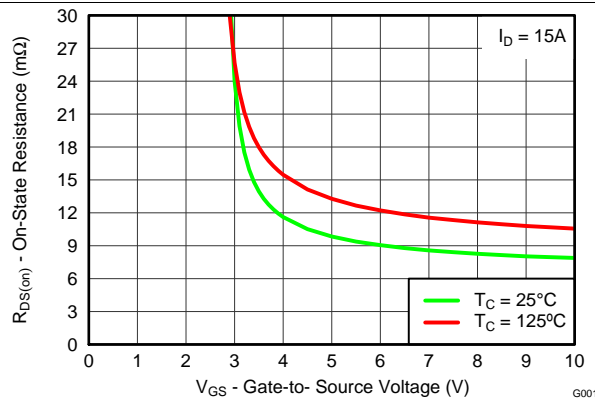

Figure 19. Control MOSFET R_{DS(on)} vs V_{GS}

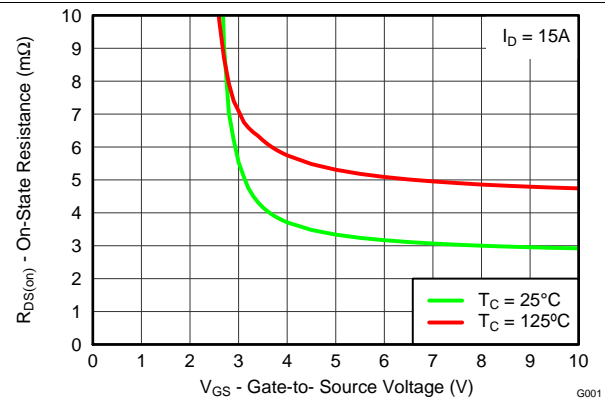

Figure 20. Sync MOSFET R_{DS(on)} vs V_{GS}

Typical Power Block MOSFET Characteristics (continued)

T_A = 25°C, unless stated otherwise.

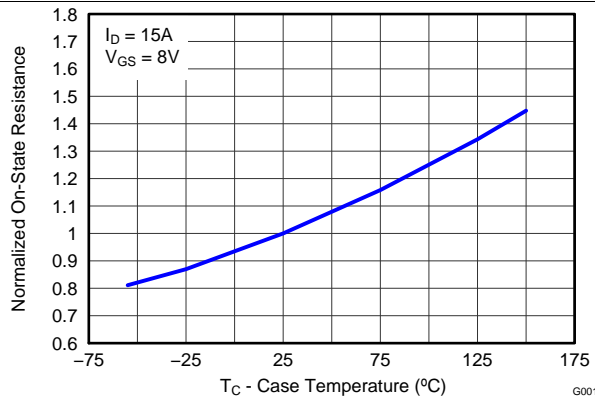

Figure 21. Control MOSFET Normalized R_{DS(on)}

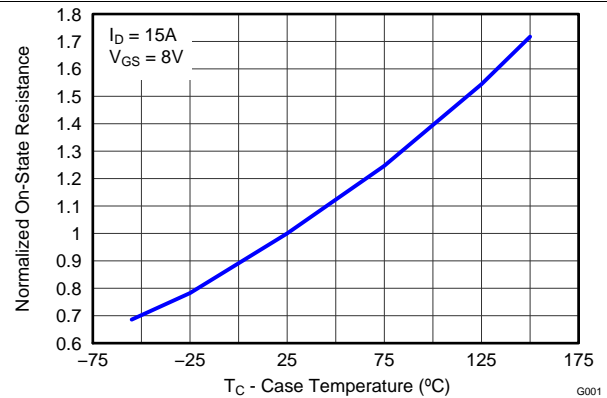

Figure 22. Sync MOSFET Normalized R_{DS(on)}

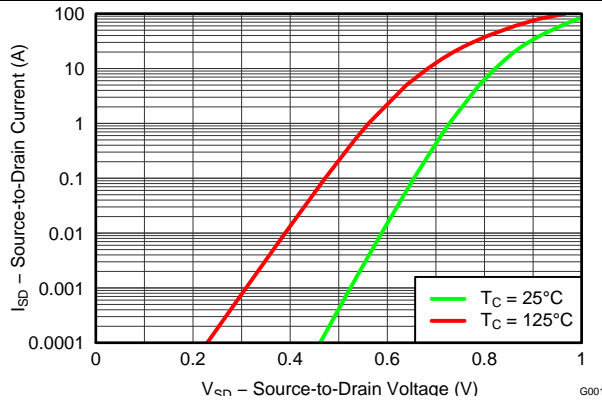

Figure 23. Control MOSFET Body Diode

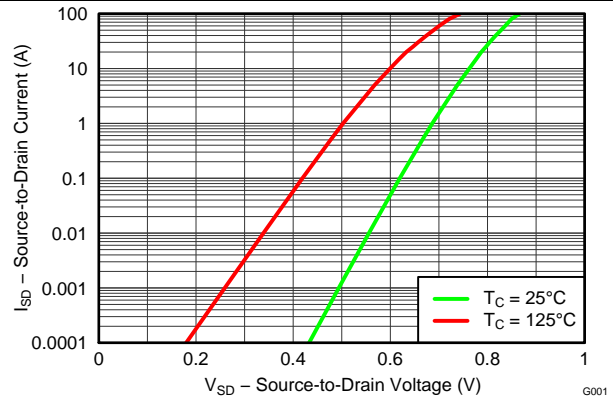

Figure 24. Sync MOSFET Body Diode

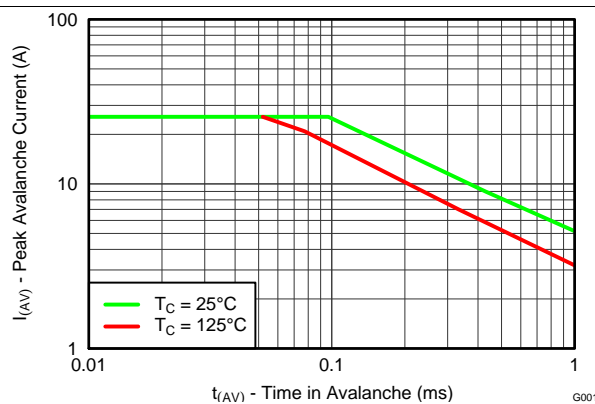

Figure 25. Control MOSFET Unclamped Inductive Switching

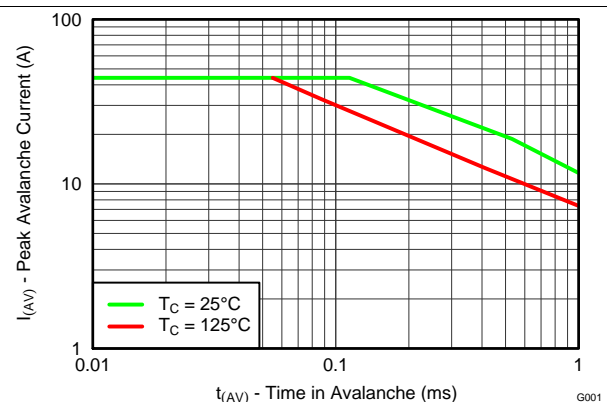

Figure 26. Sync MOSFET Unclamped Inductive Switching

6 Application and Implementation

6.1 Application Information

The CSD87588N NexFET power block is an optimized design for synchronous buck applications using 5 V gate drive. The Control FET and Sync FET silicon are parametrically tuned to yield the lowest power loss and highest system efficiency. As a result, a new rating method is needed which is tailored toward a more systems-centric environment. System-level performance curves such as Power Loss, Safe Operating Area, and normalized graphs allow engineers to predict the product performance in the actual application.

6.1.1 Power Loss Curves

MOSFET-centric parameters such as $R_{DS(ON)}$ and Q_{gd} are needed to estimate the loss generated by the devices. To simplify the design process for engineers, TI has provided measured power loss performance curves. [Figure 1](#) plots the power loss of the CSD87588N as a function of load current. This curve is measured by configuring and running the CSD87588N as it would be in the final application (see [Figure 27](#)). The measured power loss is the CSD87588N loss and consists of both input conversion loss and gate drive loss. [Equation 1](#) is used to generate the power loss curve.

$$(V_{IN} \times I_{IN}) + (V_{DD} \times I_{DD}) - (V_{SW_AVG} \times I_{OUT}) = \text{Power Loss} \tag{1}$$

The power loss curve in [Figure 1](#) is measured at the maximum recommended junction temperatures of 125°C under isothermal test conditions.

6.1.2 Safe Operating Curves (SOA)

The SOA curves in the CSD87588N data sheet provide guidance on the temperature boundaries within an operating system by incorporating the thermal resistance and system power loss. [Figure 3](#) to [Figure 4](#) outline the temperature and airflow conditions required for a given load current. The area under the curve dictates the safe operating area. All the curves are based on measurements made on a PCB design with dimensions of 4 inches (W) x 3.5 inches (L) x 0.062 inch (T) and 6 copper layers of 1 oz. copper thickness.

6.1.3 Normalized Curves

The normalized curves in the CSD87588N data sheet provides guidance on the Power Loss and SOA adjustments based on their application-specific needs. These curves show how the power loss and SOA boundaries adjust for a given set of systems conditions. The primary y-axis is the normalized change in power loss and the secondary y-axis is the change in system temperature required in order to comply with the SOA curve. The change in power loss is a multiplier for the Power Loss curve and the change in temperature is subtracted from the SOA curve.

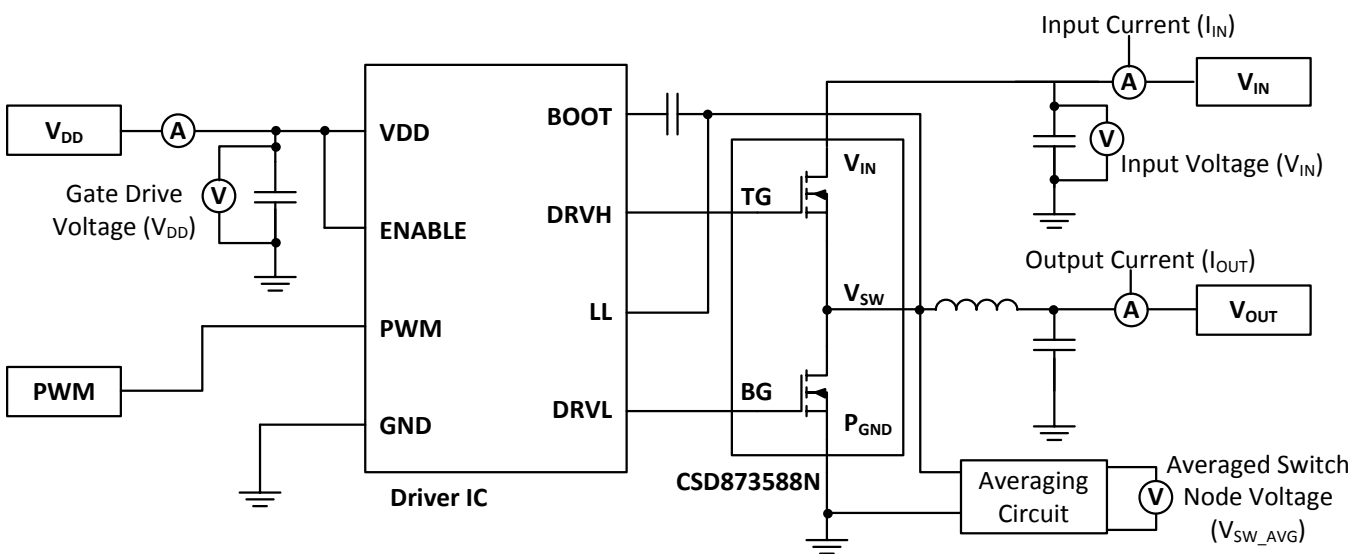

Figure 27. Typical Application

Application Information (continued)

6.1.4 Calculating Power Loss and SOA

The user can estimate product loss and SOA boundaries by arithmetic means (see [Design Example](#)). Though the Power Loss and SOA curves in this data sheet are taken for a specific set of test conditions, the following procedure outlines the steps the user should take to predict product performance for any set of system conditions.

6.1.4.1 Design Example

Operating Conditions:

- Output Current = 15 A
- Input Voltage = 7 V
- Output Voltage = 1 V
- Switching Frequency = 800 kHz
- Inductor = 0.2 μ H

6.1.4.2 Calculating Power Loss

- Power Loss at 15 A = 2.75 W ([Figure 1](#))
- Normalized Power Loss for input voltage \approx 1.03 ([Figure 6](#))
- Normalized Power Loss for output voltage \approx 0.94 ([Figure 7](#))
- Normalized Power Loss for switching frequency \approx 1.08 ([Figure 5](#))
- Normalized Power Loss for output inductor \approx 1.03 ([Figure 8](#))
- **Final calculated Power Loss = 2.75 W \times 1.05 \times 0.95 \times 1.05 \times 1.05 \approx 3.02 W**

6.1.4.3 Calculating SOA Adjustments

- SOA adjustment for input voltage \approx 0.3°C ([Figure 6](#))
- SOA adjustment for output voltage \approx -0.5°C ([Figure 7](#))
- SOA adjustment for switching frequency \approx 0.7°C ([Figure 5](#))
- SOA adjustment for output inductor \approx 0.3°C ([Figure 8](#))
- **Final calculated SOA adjustment = 0.3 + (-0.5) + 0.7 + 0.3 \approx 0.8°C**

In the previous design example, the estimated power loss of the CSD87588N would increase to 3.02 W. In addition, the maximum allowable board and/or ambient temperature would have to decrease by 0.8°C. [Figure 28](#) graphically shows how the SOA curve would be adjusted accordingly.

1. Start by drawing a horizontal line from the application current to the SOA curve.
2. Draw a vertical line from the SOA curve intercept down to the board/ambient temperature.
3. Adjust the SOA board/ambient temperature by subtracting the temperature adjustment value.

Application Information (continued)

In the design example, the SOA temperature adjustment yields a reduction in allowable board/ambient temperature of 0.8°C. In the event the adjustment value is a negative number, subtracting the negative number would yield an increase in allowable board/ambient temperature.

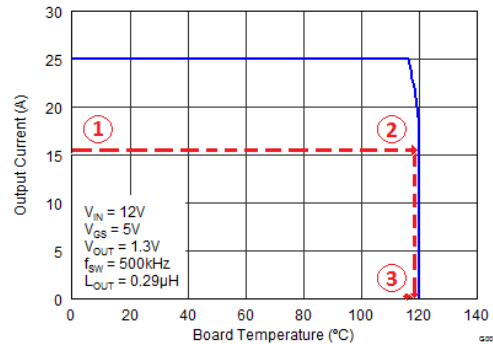

Figure 28. Power Block SOA

7 Layout

7.1 Layout Guidelines

There are two key system-level parameters that can be addressed with a proper PCB design: electrical and thermal performance. Properly optimizing the PCB layout yields maximum performance in both areas. The following sections provide a brief description on how to address each parameter.

7.1.1 Electrical Performance

The CSD87588N has the ability to switch voltages at rates greater than 10 kV/μs. Take special care with the PCB layout design and placement of the input capacitors, inductor, and output capacitors.

- The placement of the input capacitors relative to VIN and PGND pins of CSD87588N device should have the highest priority during the component placement routine. It is critical to minimize these node lengths. As such, ceramic input capacitors need to be placed as close as possible to the VIN and PGND pins (see Figure 29). The example in Figure 29 uses 1 x 10 nF 0402 25 V and 4 x 10 μF 1206 25 V ceramic capacitors (TDK part number C3216X5R1C106KT or equivalent). Notice there are ceramic capacitors on both sides of the board with an appropriate amount of vias interconnecting both layers. In terms of priority of placement next to the Power Stage C21, C5, C8, C19, and C18 should follow in order.
- The switching node of the output inductor should be placed relatively close to the Power Block II CSD87588N VSW pins. Minimizing the VSW node length between these two components will reduce the PCB conduction losses and actually reduce the switching noise level. See Figure 29. ⁽¹⁾

7.1.2 Thermal Performance

The CSD87588N has the ability to utilize the PGND planes as the primary thermal path. As such, the use of thermal vias is an effective way to pull away heat from the device and into the system board. Concerns of solder voids and manufacturability problems can be addressed by the use of three basic tactics to minimize the amount of solder attach that wicks down the via barrel:

- Intentionally space out the vias from each other to avoid a cluster of holes in a given area.
- Use the smallest drill size allowed in your design. The example in Figure 29 uses vias with a 10 mil drill hole and a 16 mil capture pad.
- Tent the opposite side of the via with solder-mask.

The number and drill size of the thermal vias should align with the end user's PCB design rules and manufacturing capabilities.

7.2 Layout Example

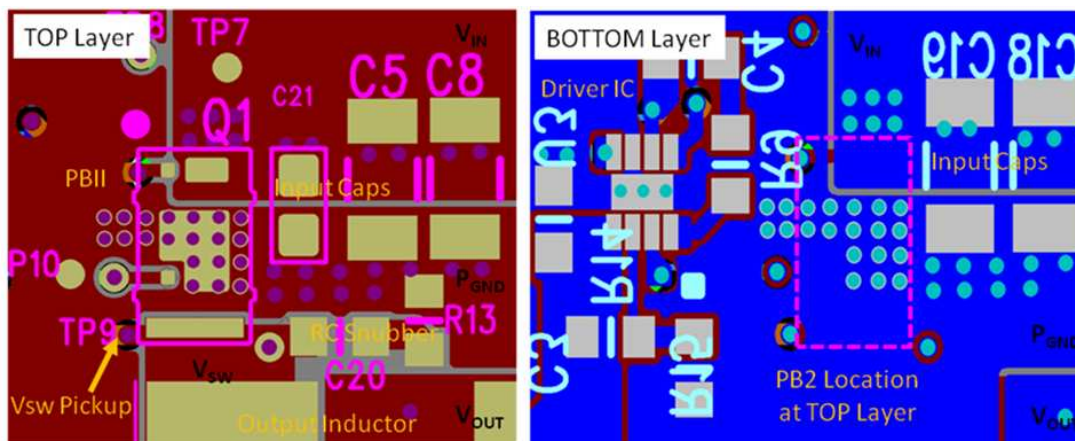

Figure 29. Recommended PCB Layout (Top Down View)

(1) Keong W. Kam, David Pommerenke, "EMI Analysis Methods for Synchronous Buck Converter EMI Root Cause Analysis", University of Missouri – Rolla

8 Device and Documentation Support

8.1 Trademarks

NexFET is a trademark of Texas Instruments.
All other trademarks are the property of their respective owners.

8.2 Electrostatic Discharge Caution



These devices have limited built-in ESD protection. The leads should be shorted together or the device placed in conductive foam during storage or handling to prevent electrostatic damage to the MOS gates.

8.3 Glossary

[SLYZ022](#) — *TI Glossary*.

This glossary lists and explains terms, acronyms, and definitions.

9 Mechanical, Packaging, and Orderable Information

The following pages include mechanical, packaging, and orderable information. This information is the most current data available for the designated devices. This data is subject to change without notice and revision of this document. For browser-based versions of this data sheet, refer to the left-hand navigation.

9.1 CSD87588N Package Dimensions

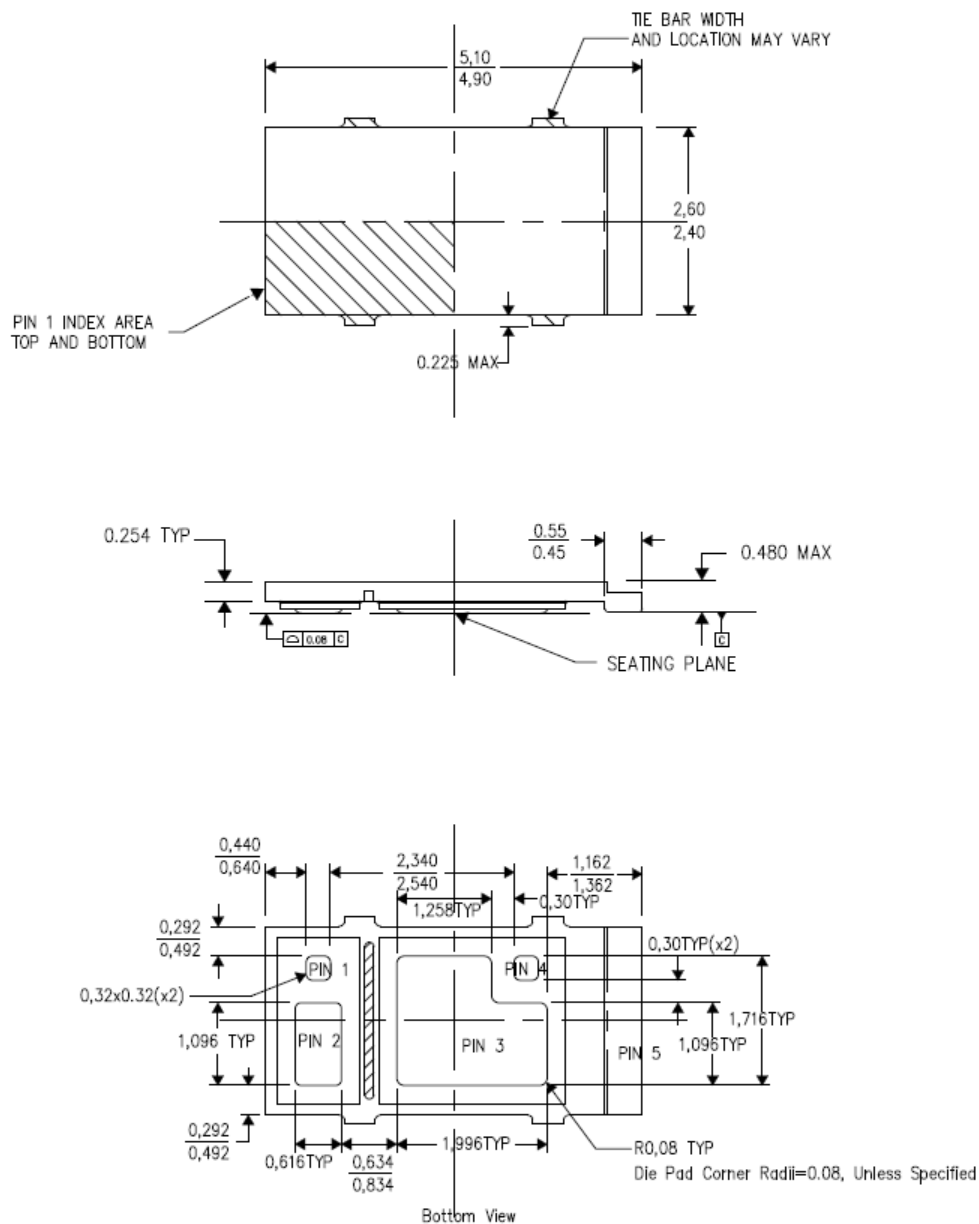

Pin Configuration

Position	Designation
Pin 1	TG
Pin 2	V _{IN}
Pin 3	P _{GND}
Pin 4	BG
Pin 5	V _{SW}

9.2 Land Pattern Recommendation

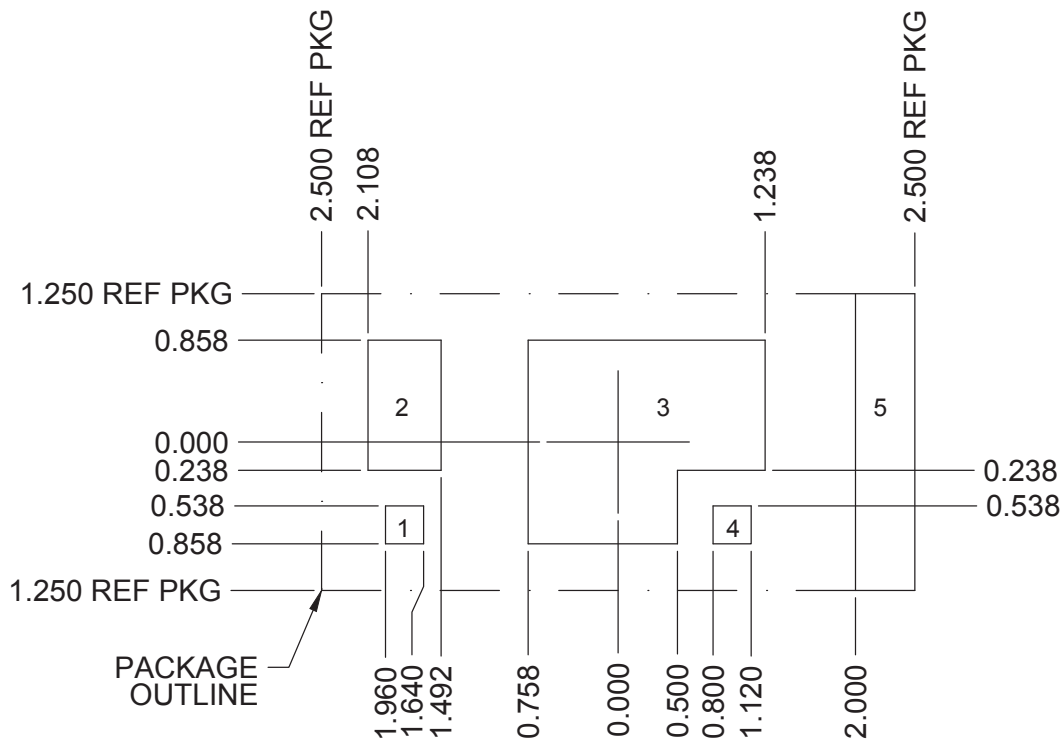

9.3 Stencil Recommendation (100 μm)

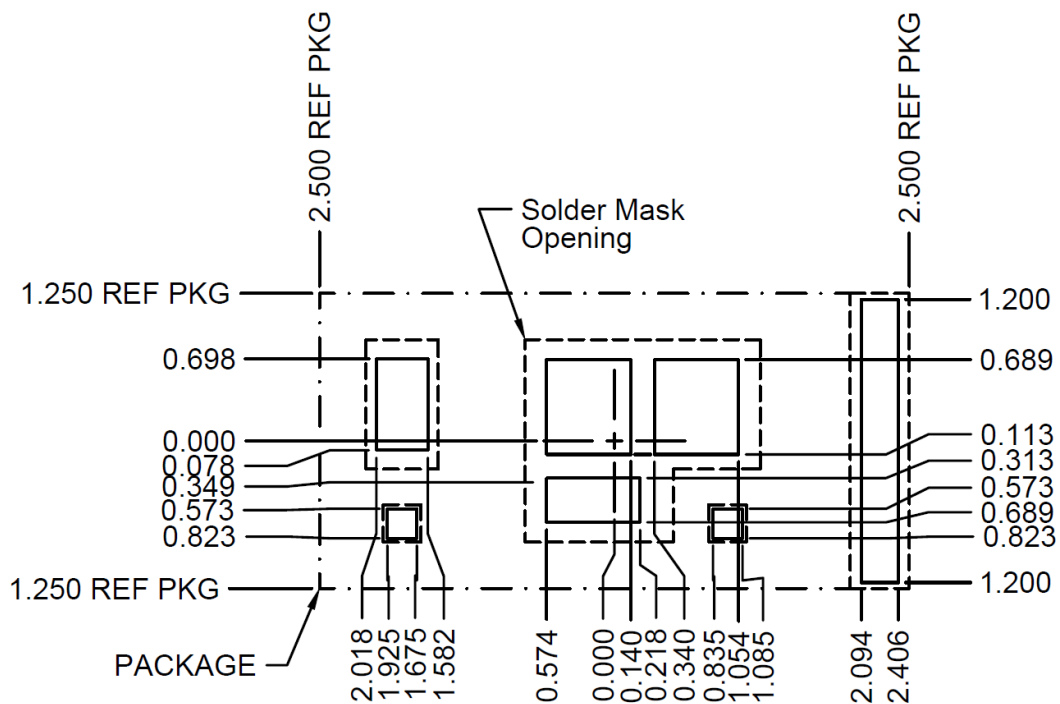

9.4 Stencil Recommendation (125 µm)

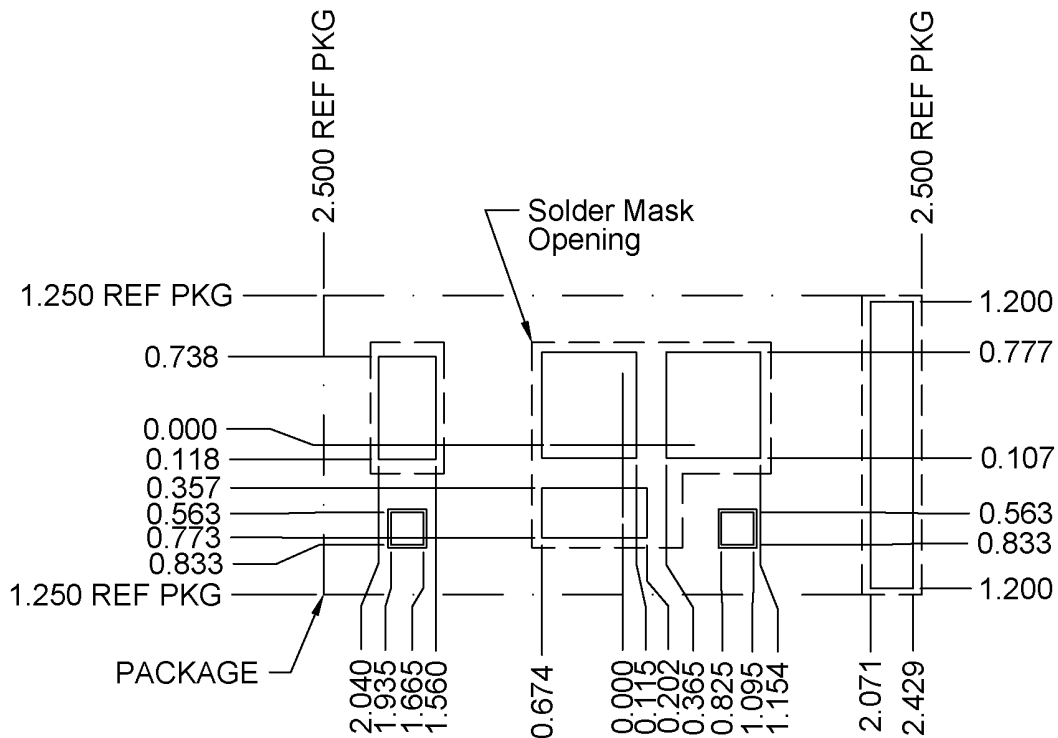

For recommended circuit layout for PCB designs, see application note [SLPA005](#) – *Reducing Ringing Through PCB Layout Techniques*.

9.5 Pin Drawing

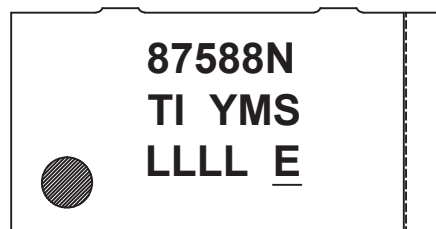

CSD87588N

SLPS384D – MARCH 2013 – REVISED APRIL 2015

www.ti.com

9.6 CSD87588N Embossed Carrier Tape Dimensions

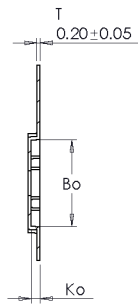

SECTION Y-Y
SCALE 3.5 : 1

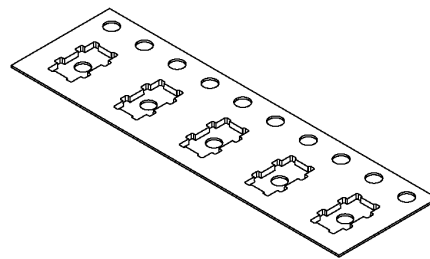
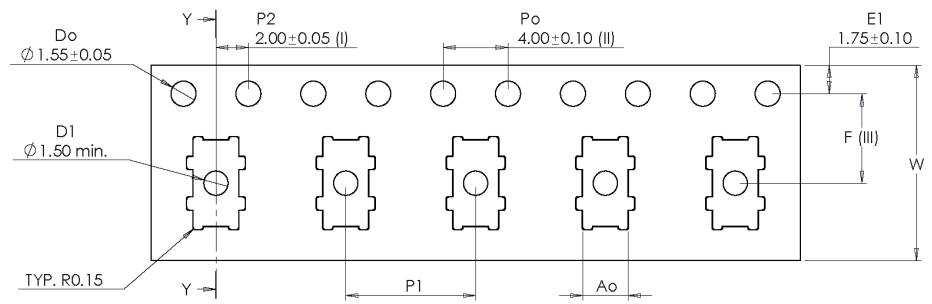

Ao	2.80	+/- 0.10
Bo	5.30	+/- 0.10
Ko	0.55	+/- 0.05
F	5.50	+/- 0.05
P1	8.00	+/- 0.10
W	12.00	+/- 0.30

Forming format : Press Form - 17
Estimated max. length : 278 meter/22B3 reel

- (I) Measured from centreline of sprocket hole to centreline of pocket.
- (II) Cumulative tolerance of 10 sprocket holes is ± 0.20 .
- (III) Measured from centreline of sprocket hole to centreline of pocket.
- (IV) Other material available.

ALL DIMENSIONS IN MILLIMETRES UNLESS OTHERWISE STATED.

(1) Pin 1 is oriented in the top-left quadrant of the tape enclosure (closest to the carrier tape sprocket holes).

PACKAGING INFORMATION

Orderable part number	Status (1)	Material type (2)	Package Pins	Package qty Carrier	RoHS (3)	Lead finish/ Ball material (4)	MSL rating/ Peak reflow (5)	Op temp (°C)	Part marking (6)
CSD87588N	Active	Production	PTAB (MPA) 5	2500 LARGE T&R	Yes	NIPDAU	Level-1-260C-UNLIM	-55 to 150	87588N
CSD87588N.B	Active	Production	PTAB (MPA) 5	2500 LARGE T&R	Yes	NIPDAU	Level-1-260C-UNLIM	-55 to 150	87588N
CSD87588NG4	Active	Production	PTAB (MPA) 5	2500 LARGE T&R	Yes	NIPDAU	Level-1-260C-UNLIM	-55 to 150	87588N
CSD87588NG4.B	Active	Production	PTAB (MPA) 5	2500 LARGE T&R	Yes	NIPDAU	Level-1-260C-UNLIM	-55 to 150	87588N
CSD87588NT	Active	Production	PTAB (MPA) 5	250 SMALL T&R	Yes	NIPDAU	Level-1-260C-UNLIM	-55 to 150	87588N
CSD87588NT.B	Active	Production	PTAB (MPA) 5	250 SMALL T&R	Yes	NIPDAU	Level-1-260C-UNLIM	-55 to 150	87588N

⁽¹⁾ **Status:** For more details on status, see our [product life cycle](#).

⁽²⁾ **Material type:** When designated, preproduction parts are prototypes/experimental devices, and are not yet approved or released for full production. Testing and final process, including without limitation quality assurance, reliability performance testing, and/or process qualification, may not yet be complete, and this item is subject to further changes or possible discontinuation. If available for ordering, purchases will be subject to an additional waiver at checkout, and are intended for early internal evaluation purposes only. These items are sold without warranties of any kind.

⁽³⁾ **RoHS values:** Yes, No, RoHS Exempt. See the [TI RoHS Statement](#) for additional information and value definition.

⁽⁴⁾ **Lead finish/Ball material:** Parts may have multiple material finish options. Finish options are separated by a vertical ruled line. Lead finish/Ball material values may wrap to two lines if the finish value exceeds the maximum column width.

⁽⁵⁾ **MSL rating/Peak reflow:** The moisture sensitivity level ratings and peak solder (reflow) temperatures. In the event that a part has multiple moisture sensitivity ratings, only the lowest level per JEDEC standards is shown. Refer to the shipping label for the actual reflow temperature that will be used to mount the part to the printed circuit board.

⁽⁶⁾ **Part marking:** There may be an additional marking, which relates to the logo, the lot trace code information, or the environmental category of the part.

Multiple part markings will be inside parentheses. Only one part marking contained in parentheses and separated by a "~" will appear on a part. If a line is indented then it is a continuation of the previous line and the two combined represent the entire part marking for that device.

Important Information and Disclaimer: The information provided on this page represents TI's knowledge and belief as of the date that it is provided. TI bases its knowledge and belief on information provided by third parties, and makes no representation or warranty as to the accuracy of such information. Efforts are underway to better integrate information from third parties. TI has taken and continues to take reasonable steps to provide representative and accurate information but may not have conducted destructive testing or chemical analysis on incoming materials and chemicals. TI and TI suppliers consider certain information to be proprietary, and thus CAS numbers and other limited information may not be available for release.

In no event shall TI's liability arising out of such information exceed the total purchase price of the TI part(s) at issue in this document sold by TI to Customer on an annual basis.

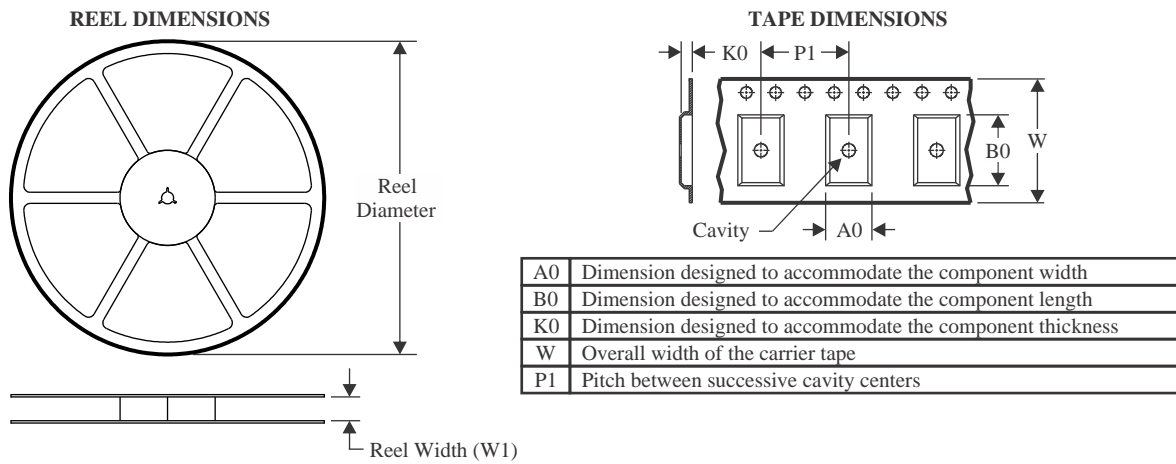
TAPE AND REEL INFORMATION

QUADRANT ASSIGNMENTS FOR PIN 1 ORIENTATION IN TAPE

*All dimensions are nominal

Device	Package Type	Package Drawing	Pins	SPQ	Reel Diameter (mm)	Reel Width W1 (mm)	A0 (mm)	B0 (mm)	K0 (mm)	P1 (mm)	W (mm)	Pin1 Quadrant
CSD87588N	PTAB	MPA	5	2500	330.0	12.4	2.8	5.3	0.55	8.0	12.0	Q1
CSD87588NG4	PTAB	MPA	5	2500	330.0	12.4	2.8	5.3	0.55	8.0	12.0	Q1
CSD87588NT	PTAB	MPA	5	250	180.0	12.4	2.8	5.3	0.55	8.0	12.0	Q1

TAPE AND REEL BOX DIMENSIONS

*All dimensions are nominal

Device	Package Type	Package Drawing	Pins	SPQ	Length (mm)	Width (mm)	Height (mm)
CSD87588N	PTAB	MPA	5	2500	346.0	346.0	33.0
CSD87588NG4	PTAB	MPA	5	2500	346.0	346.0	33.0
CSD87588NT	PTAB	MPA	5	250	182.0	182.0	20.0

IMPORTANT NOTICE AND DISCLAIMER

TI PROVIDES TECHNICAL AND RELIABILITY DATA (INCLUDING DATA SHEETS), DESIGN RESOURCES (INCLUDING REFERENCE DESIGNS), APPLICATION OR OTHER DESIGN ADVICE, WEB TOOLS, SAFETY INFORMATION, AND OTHER RESOURCES "AS IS" AND WITH ALL FAULTS, AND DISCLAIMS ALL WARRANTIES, EXPRESS AND IMPLIED, INCLUDING WITHOUT LIMITATION ANY IMPLIED WARRANTIES OF MERCHANTABILITY, FITNESS FOR A PARTICULAR PURPOSE OR NON-INFRINGEMENT OF THIRD PARTY INTELLECTUAL PROPERTY RIGHTS.

These resources are intended for skilled developers designing with TI products. You are solely responsible for (1) selecting the appropriate TI products for your application, (2) designing, validating and testing your application, and (3) ensuring your application meets applicable standards, and any other safety, security, regulatory or other requirements.

These resources are subject to change without notice. TI grants you permission to use these resources only for development of an application that uses the TI products described in the resource. Other reproduction and display of these resources is prohibited. No license is granted to any other TI intellectual property right or to any third party intellectual property right. TI disclaims responsibility for, and you will fully indemnify TI and its representatives against, any claims, damages, costs, losses, and liabilities arising out of your use of these resources.

TI's products are provided subject to [TI's Terms of Sale](#) or other applicable terms available either on [ti.com](#) or provided in conjunction with such TI products. TI's provision of these resources does not expand or otherwise alter TI's applicable warranties or warranty disclaimers for TI products.

TI objects to and rejects any additional or different terms you may have proposed.

Mailing Address: Texas Instruments, Post Office Box 655303, Dallas, Texas 75265

Copyright © 2025, Texas Instruments Incorporated