

## TSM36CA Bidirectional Surge Protection Device in SOT-23

### 1 Features

- IEC 61000-4-2 ESD protection:
  - $\pm 30\text{kV}$  contact discharge
  - $\pm 30\text{kV}$  air gap discharge
- IEC61000-4-5 surge protection:
  - 20A (8/20 $\mu\text{s}$ )
  - Clamping voltage: 55V at 20A (8/20 $\mu\text{s}$ )
- IO capacitance: 15pF (typical)
- Low leakage current of 100nA (maximum)
- Industrial temperature range:  $-55^{\circ}\text{C}$  to  $+150^{\circ}\text{C}$
- SOT-23 (DBZ) leaded package to minimize board space and allow for automatic optical inspection (AOI)

### 2 Applications

- Industrial sensors
- 4/20mA loops
- [Lighting](#)
- [Field transmitter & sensor](#)

### 3 Description

The TSM36CA is a 36V, bidirectional TVS protection diode designed for clamping harmful transients such as ESD and surge. The TSM36CA robustly shunts up to 20A of IEC 61000-4-5 fault current to protect systems from high power transients or lightning strikes. The TSM36CA device is rated to dissipate ESD strikes up to  $\pm 30\text{kV}$  (contact and air gap discharge) which exceeds the maximum level specified in the IEC 61000-4-2 international standard (Level 4).

Additionally, the TSM36CA is available in a small leaded SOT-23 (DBZ) package which is reduced in size by approximately 50 percent compared to the industry standard SMA package. The extremely low device leakage and capacitance ensures a minimal effect on the protected line.

#### Package Information

| PART NUMBER | PACKAGE <sup>(1)</sup> | PACKAGE SIZE    |
|-------------|------------------------|-----------------|
| TSM36CA     | DBZ (SOT-23, 3)        | 2.92mm × 2.37mm |

(1) For all available packages, see the orderable addendum at the end of the data sheet.

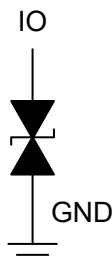

Functional Block Diagram



## Table of Contents

|  |   |  |   |
|--|---|--|---|
| <b>1 Features</b> .....                        | 1 | <b>6 Application and Implementation</b> .....                  | 6 |
| <b>2 Applications</b> .....                    | 1 | 6.1 Application Information.....                               | 6 |
| <b>3 Description</b> .....                     | 1 | <b>7 Device and Documentation Support</b> .....                | 6 |
| <b>4 Pin Configuration and Functions</b> ..... | 3 | 7.1 Documentation Support.....                                 | 6 |
| <b>5 Specifications</b> .....                  | 3 | 7.2 Receiving Notification of Documentation Updates.....       | 6 |
| 5.1 Absolute Maximum Ratings.....              | 3 | 7.3 Support Resources.....                                     | 7 |
| 5.2 ESD Ratings—JEDEC Specification.....       | 3 | 7.4 Trademarks.....  | 7 |
| 5.3 ESD Ratings—IEC Specification.....         | 3 | 7.5 Electrostatic Discharge Caution.....                       | 7 |
| 5.4 Recommended Operating Conditions.....      | 4 | 7.6 Glossary.....  | 7 |
| 5.5 Thermal Information.....                   | 4 | <b>8 Revision History</b> .....                                | 7 |
| 5.6 Electrical Characteristics.....            | 4 | <b>9 Mechanical, Packaging, and Orderable Information</b> .... | 7 |
| 5.7 Typical Characteristics.....               | 5 |  |   |

## 4 Pin Configuration and Functions

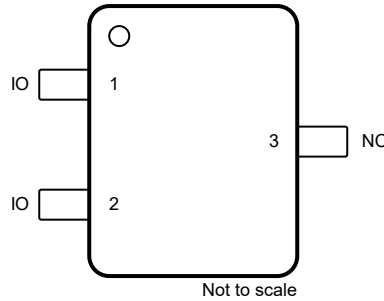

**Figure 4-1. DBZ Package,  
3-Pin SOT-23  
(Top View)**

**Table 4-1. Pin Functions**

| PIN  |     | TYPE <sup>(1)</sup> | DESCRIPTION  |
|------|-----|---------------------|--|
| NAME | NO. |                     |  |
| IO   | 1,2 | I/O                 | Surge and ESD protected IO. Connect other pin to ground. |
| NC   | 3   | NC                  | Leave this pin floating for proper performance.          |

(1) I = Input, O = Output, I/O = Input or Output, NC = No connect

## 5 Specifications

### 5.1 Absolute Maximum Ratings

$T_A = 25^\circ\text{C}$  (unless otherwise noted) <sup>(1)</sup>

| Parameter |   | MIN | MAX  | UNIT             |
|-----------|---|-----|------|------------------|
| $P_{PPM}$ | IEC 61000-4-5 Power ( $t_p - 8/20 \mu\text{s}$ ) Peak Pulse Power at $25^\circ\text{C}$     |     | 1400 | W                |
| $I_{PPM}$ | IEC 61000-4-5 Current ( $t_p - 8/20 \mu\text{s}$ ) Peak Pulse Current at $25^\circ\text{C}$ |     | 20   | A                |
| $T_A$     | Operating free-air temperature  | -55 | 150  | $^\circ\text{C}$ |
| $T_{stg}$ | Storage temperature   | -65 | 155  | $^\circ\text{C}$ |

(1) Operation outside the Absolute Maximum Ratings may cause permanent device damage. Absolute Maximum Ratings do not imply functional operation of the device at these or any other conditions beyond those listed under Recommended Operating Conditions. If used outside the Recommended Operating Conditions but within the Absolute Maximum Ratings, the device may not be fully functional, and this may affect device reliability, functionality, performance, and shorten the device lifetime.

### 5.2 ESD Ratings—JEDEC Specification

| Parameter   |                         | VALUE  | UNIT |
|-------------|-------------------------|--|------|
| $V_{(ESD)}$ | Electrostatic discharge | Human body model (HBM), per ANSI/ESDA/ JEDEC JS-001        | V    |
|             |                         | Charged device model (CDM), per JEDEC specification JS-002 |      |

### 5.3 ESD Ratings—IEC Specification

$T_A = 25^\circ\text{C}$  (unless otherwise noted)

| Parameter   |                         | VALUE                                     | UNIT |
|-------------|-------------------------|---|------|
| $V_{(ESD)}$ | Electrostatic discharge | IEC 61000-4-2 Contact Discharge, all pins | V    |
|             |                         | IEC 61000-4-2 Air-gap Discharge, all pins |      |

## 5.4 Recommended Operating Conditions

over operating free-air temperature range (unless otherwise noted)

| Parameter       |                                | MIN | NOM | MAX | UNIT |
|-----------------|--------------------------------|-----|-----|-----|------|
| V <sub>IN</sub> | Input voltage                  | -36 |     | 36  | V    |
| T <sub>A</sub>  | Operating free-air temperature | -55 |     | 150 | °C   |

## 5.5 Thermal Information

| THERMAL METRIC <sup>(1)</sup> |  | TSM36CA      | UNIT |
|-------------------------------|--|--------------|------|
|                               |  | DBZ (SOT-23) |      |
|                               |  | 3 PINS       |      |
| R <sub>θJA</sub>              | Junction-to-ambient thermal resistance       | 204.4        | °C/W |
| R <sub>θJC(top)</sub>         | Junction-to-case (top) thermal resistance    | 96.9         | °C/W |
| R <sub>θJB</sub>              | Junction-to-board thermal resistance         | 39.9         | °C/W |
| Ψ <sub>JT</sub>               | Junction-to-top characterization parameter   | 7.1          | °C/W |
| Ψ <sub>JB</sub>               | Junction-to-board characterization parameter | 39.5         | °C/W |
| R <sub>θJC(bot)</sub>         | Junction-to-case (bottom) thermal resistance | N/A          | °C/W |

(1) For more information about traditional and new thermal metrics, see the [Semiconductor and IC Package Thermal Metrics](#) application report.

## 5.6 Electrical Characteristics

T<sub>A</sub> = 25°C (unless otherwise noted)

| PARAMETER          |   | TEST CONDITIONS  | MIN  | TYP | MAX  | UNIT |
|--------------------|---|--|------|-----|------|------|
| V <sub>RWM</sub>   | Reverse stand-off voltage                                       |  | -36  |     | 36   | V    |
| V <sub>BR</sub>    | Breakdown voltage <sup>(1)</sup>                                | I <sub>IO</sub> = 10 mA, IO to GND and GND to IO           | 37.8 |     | 44.2 | V    |
| V <sub>CLAMP</sub> | Surge clamping voltage, t <sub>p</sub> = 8/20 μs <sup>(2)</sup> | I <sub>PP</sub> = 10A, IO to GND                           |      | 47  | 58   | V    |
|                    |   | I <sub>PP</sub> = 20A, IO to GND                           |      | 55  | 71   |      |
| I <sub>LEAK</sub>  | Leakage current   | V <sub>IO</sub> = +36 V                                    |      | 25  | 100  | nA   |
| R <sub>DYN</sub>   | Dynamic resistance  | t <sub>p</sub> = 8/20 μs, from IO to GND                   |      | 1.0 |      | Ω    |
| C <sub>LINE</sub>  | Line capacitance  | V <sub>IO</sub> = 0 V, f = 1 MHz, V <sub>p-p</sub> = 30 mV |      | 15  | 20   | pF   |

(1) V<sub>BR</sub> is defined as the voltage when ±10 mA is applied in the positive-going direction.

(2) Device stressed with 8/20 μs exponential decay waveform according to IEC 61000-4-5.

## 5.7 Typical Characteristics

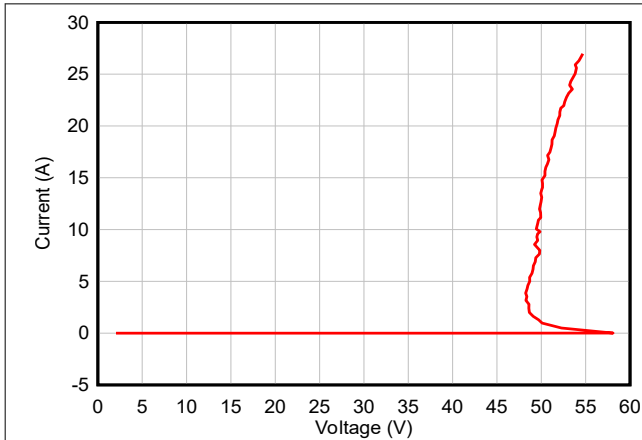

Figure 5-1. Positive TLP Curve

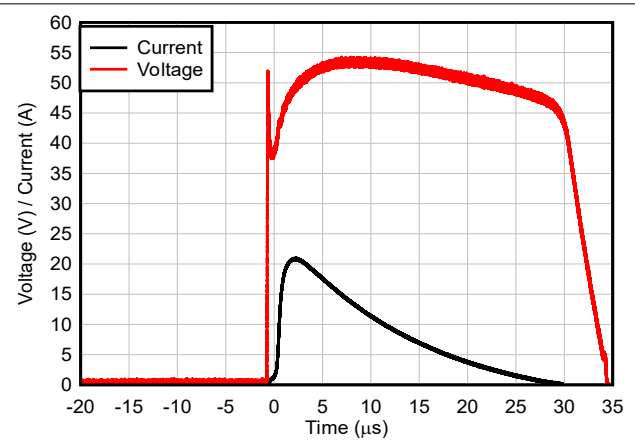

Figure 5-2. 8/20µs Surge Response

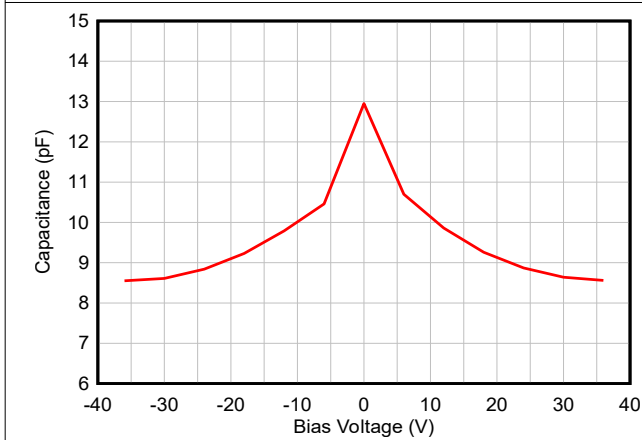

Figure 5-3. Capacitance vs Bias Voltage

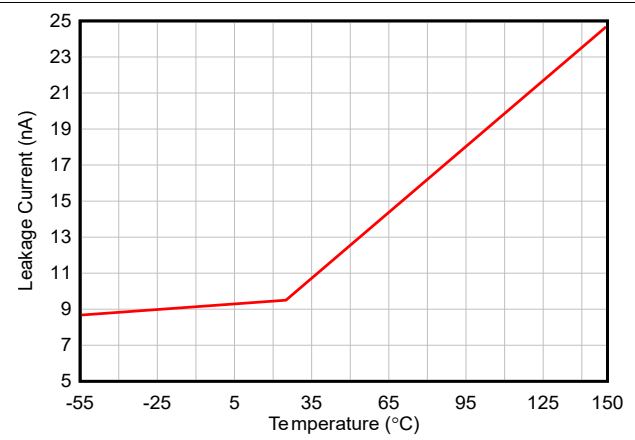

Figure 5-4. Leakage Current vs Temperature

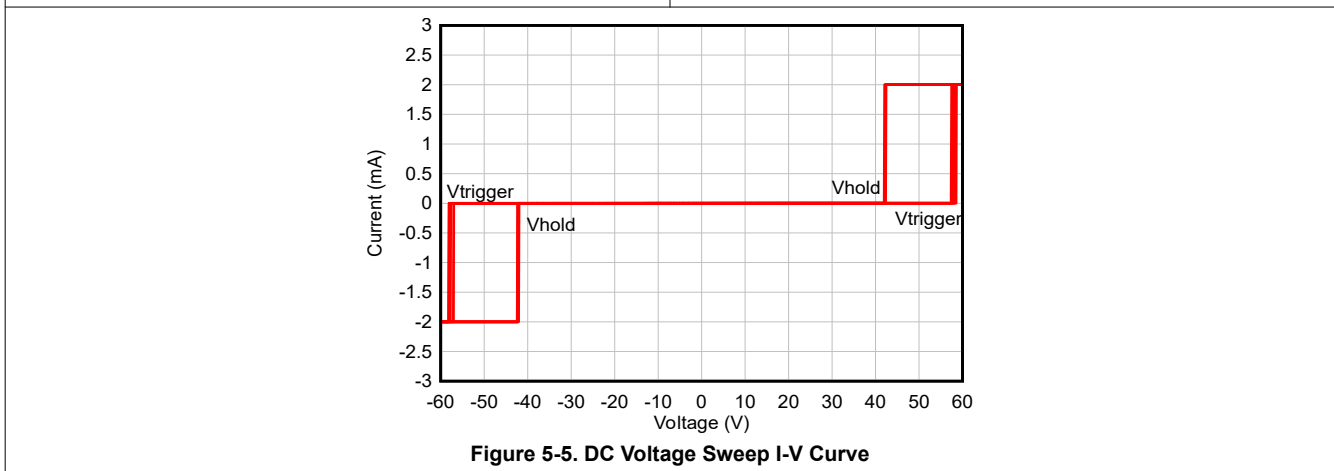

Figure 5-5. DC Voltage Sweep I-V Curve

## 6 Application and Implementation

### Note

Information in the following applications sections is not part of the TI component specification, and TI does not warrant its accuracy or completeness. TI's customers are responsible for determining suitability of components for their purposes, as well as validating and testing their design implementation to confirm system functionality.

### 6.1 Application Information

TSM36CA is a diode type TVS that provides a path to ground for dissipating transient voltage spikes, such as ESD or surge, on signal lines and power lines. Connect the device in parallel to the down stream circuitry for protection. As the current from the transient passes through the device, only a small voltage drop is present across the diode. This is the voltage presented to the protected IC. The low  $R_{DYN}$  of the triggered TVS holds this voltage ( $V_{CLAMP}$ ) to a safe level for the protected IC. For more information on how to properly use this device, refer to the [ESD Packaging and Layout Guide](#) for details.

One common example of implementing TSM36CA is to protect both sides of a PLC module and a sensor transmitter, as shown in the figure below.

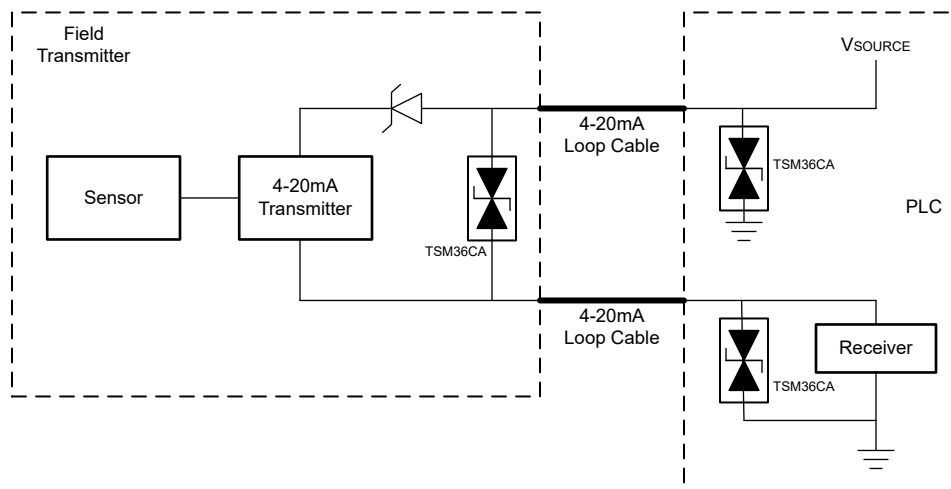

Figure 6-1. Typical Application Diagram

## 7 Device and Documentation Support

### 7.1 Documentation Support

#### 7.1.1 Related Documentation

For related documentation, see the following:

- Texas Instruments, [TI's IEC 61000-4-x Testing application note](#)
- Texas Instruments, [ESD Layout Guide user's guide](#)
- Texas Instruments, [ESD Protection Diodes EVM user's guide](#)
- Texas Instruments, [Generic ESD Evaluation Module user's guide](#)
- Texas Instruments, [Reading and Understanding an ESD Protection Data Sheet user's guide](#)

### 7.2 Receiving Notification of Documentation Updates

To receive notification of documentation updates, navigate to the device product folder on [ti.com](http://ti.com). Click on [Notifications](#) to register and receive a weekly digest of any product information that has changed. For change details, review the revision history included in any revised document.

## 7.3 Support Resources

[TI E2E™ support forums](#) are an engineer's go-to source for fast, verified answers and design help — straight from the experts. Search existing answers or ask your own question to get the quick design help you need.

Linked content is provided "AS IS" by the respective contributors. They do not constitute TI specifications and do not necessarily reflect TI's views; see TI's [Terms of Use](#).

## 7.4 Trademarks

TI E2E™ is a trademark of Texas Instruments.  
All trademarks are the property of their respective owners.

## 7.5 Electrostatic Discharge Caution



This integrated circuit can be damaged by ESD. Texas Instruments recommends that all integrated circuits be handled with appropriate precautions. Failure to observe proper handling and installation procedures can cause damage.

ESD damage can range from subtle performance degradation to complete device failure. Precision integrated circuits may be more susceptible to damage because very small parametric changes could cause the device not to meet its published specifications.

## 7.6 Glossary

[TI Glossary](#) This glossary lists and explains terms, acronyms, and definitions.

## 8 Revision History

NOTE: Page numbers for previous revisions may differ from page numbers in the current version.

| DATE        | REVISION | NOTES           |
|-------------|----------|-----------------|
| August 2024 | *        | Initial Release |

## 9 Mechanical, Packaging, and Orderable Information

The following pages include mechanical, packaging, and orderable information. This information is the most current data available for the designated devices. This data is subject to change without notice and revision of this document. For browser-based versions of this data sheet, refer to the left-hand navigation.

**PACKAGING INFORMATION**

| Orderable part number       | Status<br>(1) | Material type<br>(2) | Package   Pins   | Package qty   Carrier | RoHS<br>(3) | Lead finish/<br>Ball material<br>(4) | MSL rating/<br>Peak reflow<br>(5) | Op temp (°C) | Part marking<br>(6) |
|-----------------------------|---------------|----------------------|------------------|-----------------------|-------------|--------------------------------------|-----------------------------------|--------------|---------------------|
| <a href="#">TSM36CADBZR</a> | Active        | Production           | SOT-23 (DBZ)   3 | 3000   LARGE T&R      | Yes         | NIPDAU   SN                          | Level-1-260C-UNLIM                | -55 to 150   | (3IIG, 3LC8)        |
| TSM36CADBZR.B               | Active        | Production           | SOT-23 (DBZ)   3 | 3000   LARGE T&R      | Yes         | NIPDAU                               | Level-1-260C-UNLIM                | -55 to 150   | (3IIG, 3LC8)        |

(1) **Status:** For more details on status, see our [product life cycle](#).

(2) **Material type:** When designated, preproduction parts are prototypes/experimental devices, and are not yet approved or released for full production. Testing and final process, including without limitation quality assurance, reliability performance testing, and/or process qualification, may not yet be complete, and this item is subject to further changes or possible discontinuation. If available for ordering, purchases will be subject to an additional waiver at checkout, and are intended for early internal evaluation purposes only. These items are sold without warranties of any kind.

(3) **RoHS values:** Yes, No, RoHS Exempt. See the [TI RoHS Statement](#) for additional information and value definition.

(4) **Lead finish/Ball material:** Parts may have multiple material finish options. Finish options are separated by a vertical ruled line. Lead finish/Ball material values may wrap to two lines if the finish value exceeds the maximum column width.

(5) **MSL rating/Peak reflow:** The moisture sensitivity level ratings and peak solder (reflow) temperatures. In the event that a part has multiple moisture sensitivity ratings, only the lowest level per JEDEC standards is shown. Refer to the shipping label for the actual reflow temperature that will be used to mount the part to the printed circuit board.

(6) **Part marking:** There may be an additional marking, which relates to the logo, the lot trace code information, or the environmental category of the part.

Multiple part markings will be inside parentheses. Only one part marking contained in parentheses and separated by a "~" will appear on a part. If a line is indented then it is a continuation of the previous line and the two combined represent the entire part marking for that device.

**Important Information and Disclaimer:**The information provided on this page represents TI's knowledge and belief as of the date that it is provided. TI bases its knowledge and belief on information provided by third parties, and makes no representation or warranty as to the accuracy of such information. Efforts are underway to better integrate information from third parties. TI has taken and continues to take reasonable steps to provide representative and accurate information but may not have conducted destructive testing or chemical analysis on incoming materials and chemicals. TI and TI suppliers consider certain information to be proprietary, and thus CAS numbers and other limited information may not be available for release.

In no event shall TI's liability arising out of such information exceed the total purchase price of the TI part(s) at issue in this document sold by TI to Customer on an annual basis.

**OTHER QUALIFIED VERSIONS OF TSM36CA :**

- Automotive : [TSM36CA-Q1](#)

**NOTE: Qualified Version Definitions:**

- Automotive - Q100 devices qualified for high-reliability automotive applications targeting zero defects



# EXAMPLE BOARD LAYOUT

DBZ0003A

SOT-23 - 1.12 mm max height

SMALL OUTLINE TRANSISTOR

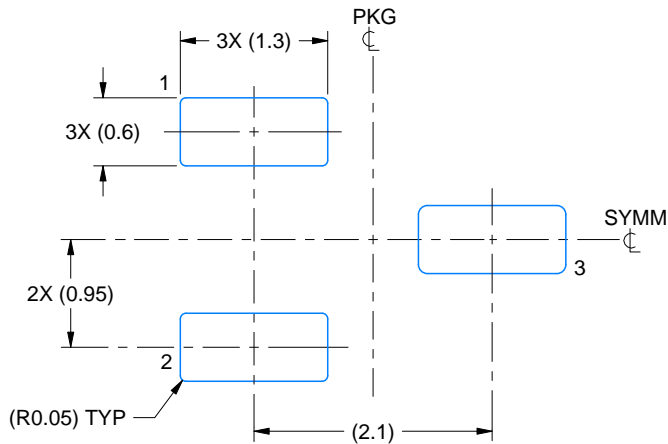

LAND PATTERN EXAMPLE  
SCALE:15X

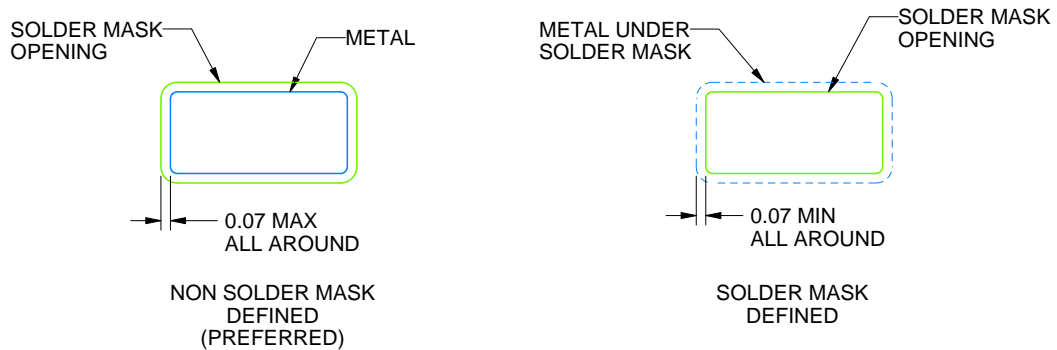

SOLDER MASK DETAILS

4214838/F 08/2024

NOTES: (continued)

- 5. Publication IPC-7351 may have alternate designs.
- 6. Solder mask tolerances between and around signal pads can vary based on board fabrication site.

# EXAMPLE STENCIL DESIGN

DBZ0003A

SOT-23 - 1.12 mm max height

SMALL OUTLINE TRANSISTOR

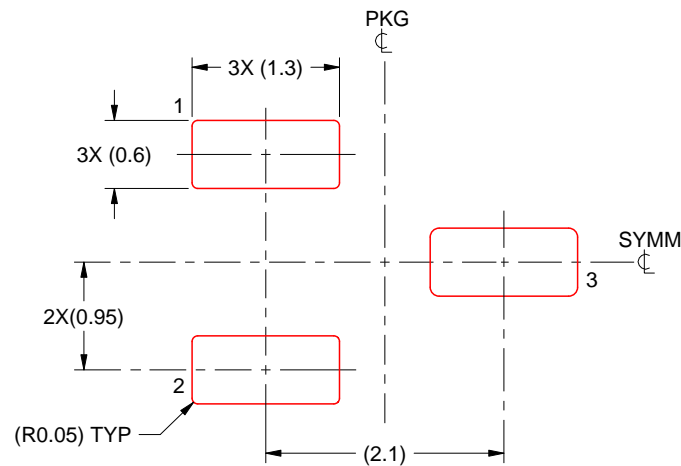

SOLDER PASTE EXAMPLE  
BASED ON 0.125 THICK STENCIL  
SCALE:15X

4214838/F 08/2024

NOTES: (continued)

7. Laser cutting apertures with trapezoidal walls and rounded corners may offer better paste release. IPC-7525 may have alternate design recommendations.
8. Board assembly site may have different recommendations for stencil design.

## IMPORTANT NOTICE AND DISCLAIMER

TI PROVIDES TECHNICAL AND RELIABILITY DATA (INCLUDING DATA SHEETS), DESIGN RESOURCES (INCLUDING REFERENCE DESIGNS), APPLICATION OR OTHER DESIGN ADVICE, WEB TOOLS, SAFETY INFORMATION, AND OTHER RESOURCES "AS IS" AND WITH ALL FAULTS, AND DISCLAIMS ALL WARRANTIES, EXPRESS AND IMPLIED, INCLUDING WITHOUT LIMITATION ANY IMPLIED WARRANTIES OF MERCHANTABILITY, FITNESS FOR A PARTICULAR PURPOSE OR NON-INFRINGEMENT OF THIRD PARTY INTELLECTUAL PROPERTY RIGHTS.

These resources are intended for skilled developers designing with TI products. You are solely responsible for (1) selecting the appropriate TI products for your application, (2) designing, validating and testing your application, and (3) ensuring your application meets applicable standards, and any other safety, security, regulatory or other requirements.

These resources are subject to change without notice. TI grants you permission to use these resources only for development of an application that uses the TI products described in the resource. Other reproduction and display of these resources is prohibited. No license is granted to any other TI intellectual property right or to any third party intellectual property right. TI disclaims responsibility for, and you will fully indemnify TI and its representatives against, any claims, damages, costs, losses, and liabilities arising out of your use of these resources.

TI's products are provided subject to [TI's Terms of Sale](#) or other applicable terms available either on [ti.com](https://www.ti.com) or provided in conjunction with such TI products. TI's provision of these resources does not expand or otherwise alter TI's applicable warranties or warranty disclaimers for TI products.

TI objects to and rejects any additional or different terms you may have proposed.

Mailing Address: Texas Instruments, Post Office Box 655303, Dallas, Texas 75265

Copyright © 2025, Texas Instruments Incorporated