

SN54LS139A, SN54S139, SN74LS139A, SN74S139A DUAL 2-LINE TO 4-LINE DECODERS/DEMULTIPLEXERS

SDLS013

DECEMBER 1972—REVISED MARCH 1988

- Designed Specifically for High-Speed: Memory Decoders Data Transmission Systems
- Two Fully Independent 2- to 4-Line Decoders/Demultiplexers
- Schottky Clamped for High Performance

description

These Schottky-clamped TTL MSI circuits are designed to be used in high-performance memory-decoding or data-routing applications requiring very short propagation delay times. In high-performance memory systems, these decoders can be used to minimize the effects of system decoding. When employed with high-speed memories utilizing a fast-enable circuit, the delay times of these decoders and the enable time of the memory are usually less than the typical access time of the memory. This means that the effective system delay introduced by the Schottky-clamped system decoder is negligible.

The circuit comprises two individual two-line to four-line decoders in a single package. The active-low enable input can be used as a data line in demultiplexing applications.

All of these decoders/demultiplexers feature fully buffered inputs, each of which represents only one normalized load to its driving circuit. All inputs are clamped with high-performance Schottky diodes to suppress line-ringing and to simplify system design. The SN54LS139A and SN54S139 are characterized for operation range of -55°C to 125°C . The SN74LS139A and SN74S139A are characterized for operation from 0°C to 70°C .

FUNCTION TABLE

INPUTS			OUTPUTS			
ENABLE	SELECT		Y0	Y1	Y2	Y3
$\overline{\text{G}}$	B	A				
H	X	X	H	H	H	H
L	L	L	L	H	H	H
L	L	H	H	L	H	H
L	H	L	H	H	L	H
L	H	H	H	H	H	L

H = high level, L = low level, X = irrelevant

SN54LS139A, SN54S139 . . . J OR W PACKAGE
SN74LS139A, SN74S139A . . . D OR N PACKAGE

(TOP VIEW)

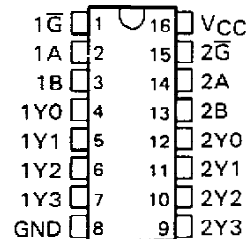

SN54LS139A, SN54S139 . . . FK PACKAGE

(TOP VIEW)

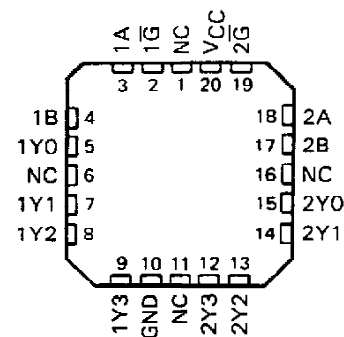

NC—No internal connection

logic symbols (alternatives)†

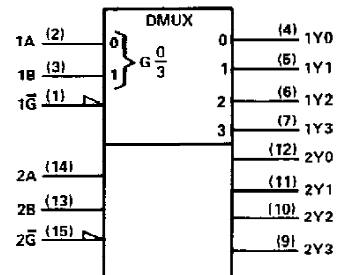
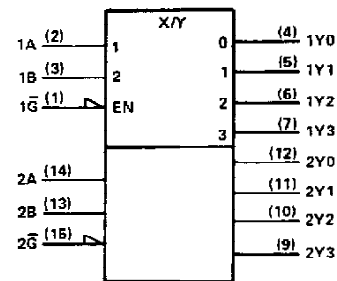

†These symbols are in accordance with ANSI/IEEE Std. 91-1984 and IEC Publication 617-12.

Pin numbers shown are for D, J, N, and W packages.

PRODUCTION DATA documents contain information current as of publication date. Products conform to specifications per the terms of Texas Instruments standard warranty. Production processing does not necessarily include testing of all parameters.

TEXAS
INSTRUMENTS

POST OFFICE BOX 655012 • DALLAS, TEXAS 75265

Copyright © 1972, Texas Instruments Incorporated

SN54LS139A, SN74LS139A DUAL 2-LINE TO 4-LINE DECODERS/DEMULTIPLEXERS

recommended operating conditions

		SN54LS139A			SN74LS139A			UNIT
		MIN	NOM	MAX	MIN	NOM	MAX	
V _{CC}	Supply voltage	4.5	5	5.5	4.75	5	5.25	V
V _{IH}	High-level input voltage	2			2			V
V _{IL}	Low-level input voltage			0.7			0.8	V
I _{OH}	High-level output current			-0.4			-0.4	mA
I _{OL}	Low-level output current			4			8	mA
T _A	Operating free-air temperature	-55		125	0		70	°C

electrical characteristics over recommended operating free-air temperature range (unless otherwise noted)

PARAMETER	TEST CONDITIONS [†]	SN54LS139A		SN74LS139A		UNIT		
		MIN	TYP [‡]	MAX	MIN		TYP [‡]	MAX
V _{IK}	V _{CC} = MIN, I _I = -18 mA			-1.5		-1.5	V	
V _{OH}	V _{CC} = MIN, V _{IH} = 2 V, V _{IL} = MAX, I _{OH} = -0.4 mA	2.5	3.4		2.7	3.4	V	
V _{OL}	V _{CC} = MIN, V _{IH} = 2 V, V _{IL} = MAX	I _{OL} = 4 mA		0.25	0.4	0.25	0.4	V
		I _{OL} = 8 mA				0.35	0.5	
I _I	V _{CC} = MAX, V _I = 7 V			0.1		0.1	mA	
I _{IH}	V _{CC} = MAX, V _I = 2.7 V			20		20	μA	
I _{IL}	V _{CC} = MAX, V _I = 0.4 V			-0.4		-0.4	mA	
I _{OS} [§]	V _{CC} = MAX	-20		-100	-20	-100	mA	
I _{CC}	V _{CC} = MAX, Outputs enabled and open		6.8	11		6.8	11	mA

[†] For conditions shown as MIN or MAX, use the appropriate value specified under recommended operating conditions.

[‡] All typical values are at V_{CC} = 5 V, T_A = 25°C.

[§] Not more than one output should be shorted at a time, and duration of the short circuit test should not exceed one second.

switching characteristics, V_{CC} = 5 V, T_A = 25°C (see Note 2)

PARAMETER [¶]	FROM (INPUT)	TO (OUTPUT)	LEVELS OF DELAY	TEST CONDITIONS	SN54LS139A SN74LS139A			UNIT
					MIN	TYP	MAX	
t _{PLH}	Binary Select	Any	2	R _L = 2 kΩ, C _L = 15 pF		13	20	ns
t _{PHL}						22	33	ns
t _{PLH}			3			18	29	ns
t _{PHL}						25	38	ns
t _{PLH}	Enable	Any	2			16	24	ns
t _{PHL}						21	32	ns

[¶] t_{PLH} = propagation delay time, low-to-high-level output

t_{PHL} = propagation delay time, high-to-low-level output

NOTE 2: Load circuits and voltage waveforms are shown in Section 1.

**TEXAS
INSTRUMENTS**

POST OFFICE BOX 655012 • DALLAS, TEXAS 75265

SN54S139, SN74S139A

DUAL 2-LINE TO 4-LINE DECODERS/DEMULTIPLIERS

recommended operating conditions

		SN54S139			SN74S139A			UNIT		
		MIN	NOM	MAX	MIN	NOM	MAX			
V _{CC}	Supply voltage	4.5	5	5.5	4.75	5	5.25	V		
V _{IH}	High-level input voltage	2			2			V		
V _{IL}	Low-level input voltage	0.8			0.8			V		
I _{OH}	High-level output current	-1			-1			mA		
I _{OL}	Low-level output current	20			20			mA		
T _A	Operating free-air temperature	-55			125			0	70	°C

electrical characteristics over recommended operating free-air temperature range (unless otherwise noted)

PARAMETER	TEST CONDITIONS†	SN54S139 SN74S139A			UNIT	
		MIN	TYP‡	MAX		
V _{IK}	V _{CC} = MIN, I _I = -18 mA	-1.2			V	
V _{OH}	V _{CC} = MIN, V _{IH} = 2 V, V _{IL} = 0.8 V, I _{OH} = -1 mA	SN54S*	2.5	3.4	V	
		SN74S*	2.7	3.4		
V _{OL}	V _{CC} = MIN, V _{IH} = 2 V, V _{IL} = 0.8 V, I _{OL} = 20 mA	0.5			V	
I _I	V _{CC} = MAX, V _I = 5.5 V	1			mA	
I _{IH}	V _{CC} = MAX, V _I = 2.7 V	50			μA	
I _{IL}	V _{CC} = MAX, V _I = 0.5 V	-2			mA	
I _{OS} §	V _{CC} = MAX	-40	-100		mA	
I _{CC}	V _{CC} = MAX, Outputs enabled and open	60			90	mA

† For conditions shown as MIN or MAX, use the appropriate value specified under recommended operating conditions.

‡ All typical values are at V_{CC} = 5 V, T_A = 25°C.

§ Not more than one output should be shorted at a time, and duration of the short circuit test should not exceed one second.

switching characteristics, V_{CC} = 5 V, T_A = 25°C (see Note 2)

PARAMETER†	FROM (INPUT)	TO (OUTPUT)	LEVELS OF DELAY	TEST CONDITIONS	SN54S139 SN74S139A			UNIT
					MIN	TYP	MAX	
t _{PLH}	Binary Select	Any	2	R _L = 280 Ω, C _L = 15 pF	5	7.5	ns	
t _{PHL}					6.5	10	ns	
t _{PLH}			3		7	12	ns	
t _{PHL}					8	12	ns	
t _{PLH}	Enable	Any	2		5	8	ns	
t _{PHL}					6.5	10	ns	

† t_{PLH} = propagation delay time, low-to-high-level output

t_{PHL} = propagation delay time, high-to-low-level output

NOTE 2: Load circuits and voltage waveforms are shown in Section 1.

TEXAS
INSTRUMENTS

POST OFFICE BOX 655012 • DALLAS, TEXAS 75265

PACKAGING INFORMATION

Orderable part number	Status (1)	Material type (2)	Package Pins	Package qty Carrier	RoHS (3)	Lead finish/ Ball material (4)	MSL rating/ Peak reflow (5)	Op temp (°C)	Part marking (6)
76007012A	Active	Production	LCCC (FK) 20	55 TUBE	No	SNPB	N/A for Pkg Type	-55 to 125	76007012A SNJ54LS 139AFK
7600701EA	Active	Production	CDIP (J) 16	25 TUBE	No	SNPB	N/A for Pkg Type	-55 to 125	7600701EA SNJ54LS139AJ
7600701FA	Active	Production	CFP (W) 16	25 TUBE	No	SNPB	N/A for Pkg Type	-55 to 125	7600701FA SNJ54LS139AW
7700401EA	Active	Production	CDIP (J) 16	25 TUBE	No	SNPB	N/A for Pkg Type	-55 to 125	7700401EA SNJ54S139J
7700401FA	Active	Production	CFP (W) 16	25 TUBE	No	SNPB	N/A for Pkg Type	-55 to 125	7700401FA SNJ54S139W
JM38510/30702B2A	Active	Production	LCCC (FK) 20	55 TUBE	No	SNPB	N/A for Pkg Type	-55 to 125	JM38510/ 30702B2A
JM38510/30702B2A.A	Active	Production	LCCC (FK) 20	55 TUBE	No	SNPB	N/A for Pkg Type	-55 to 125	JM38510/ 30702B2A
JM38510/30702BEA	Active	Production	CDIP (J) 16	25 TUBE	No	SNPB	N/A for Pkg Type	-55 to 125	JM38510/ 30702BEA
JM38510/30702BEA.A	Active	Production	CDIP (J) 16	25 TUBE	No	SNPB	N/A for Pkg Type	-55 to 125	JM38510/ 30702BEA
JM38510/30702BFA	Active	Production	CFP (W) 16	25 TUBE	No	SNPB	N/A for Pkg Type	-55 to 125	JM38510/ 30702BFA
JM38510/30702BFA.A	Active	Production	CFP (W) 16	25 TUBE	No	SNPB	N/A for Pkg Type	-55 to 125	JM38510/ 30702BFA
JM38510/30702SEA	Active	Production	CDIP (J) 16	25 TUBE	No	SNPB	N/A for Pkg Type	-55 to 125	JM38510/ 30702SEA
JM38510/30702SEA.A	Active	Production	CDIP (J) 16	25 TUBE	No	SNPB	N/A for Pkg Type	-55 to 125	JM38510/ 30702SEA
JM38510/30702SFA	Active	Production	CFP (W) 16	25 TUBE	No	SNPB	N/A for Pkg Type	-55 to 125	JM38510/ 30702SFA
JM38510/30702SFA.A	Active	Production	CFP (W) 16	25 TUBE	No	SNPB	N/A for Pkg Type	-55 to 125	JM38510/ 30702SFA
M38510/30702B2A	Active	Production	LCCC (FK) 20	55 TUBE	No	SNPB	N/A for Pkg Type	-55 to 125	JM38510/ 30702B2A

Orderable part number	Status (1)	Material type (2)	Package Pins	Package qty Carrier	RoHS (3)	Lead finish/ Ball material (4)	MSL rating/ Peak reflow (5)	Op temp (°C)	Part marking (6)
M38510/30702BEA	Active	Production	CDIP (J) 16	25 TUBE	No	SNPB	N/A for Pkg Type	-55 to 125	JM38510/ 30702BEA
M38510/30702BFA	Active	Production	CFP (W) 16	25 TUBE	No	SNPB	N/A for Pkg Type	-55 to 125	JM38510/ 30702BFA
M38510/30702SEA	Active	Production	CDIP (J) 16	25 TUBE	No	SNPB	N/A for Pkg Type	-55 to 125	JM38510/ 30702SEA
M38510/30702SFA	Active	Production	CFP (W) 16	25 TUBE	No	SNPB	N/A for Pkg Type	-55 to 125	JM38510/ 30702SFA
SN54LS139AJ	Active	Production	CDIP (J) 16	25 TUBE	No	SNPB	N/A for Pkg Type	-55 to 125	SN54LS139AJ
SN54LS139AJ.A	Active	Production	CDIP (J) 16	25 TUBE	No	SNPB	N/A for Pkg Type	-55 to 125	SN54LS139AJ
SN54S139J	Active	Production	CDIP (J) 16	25 TUBE	No	SNPB	N/A for Pkg Type	-55 to 125	SN54S139J
SN54S139J.A	Active	Production	CDIP (J) 16	25 TUBE	No	SNPB	N/A for Pkg Type	-55 to 125	SN54S139J
SN74LS139AD	Obsolete	Production	SOIC (D) 16	-	-	Call TI	Call TI	0 to 70	LS139A
SN74LS139ADR	Active	Production	SOIC (D) 16	2500 LARGE T&R	Yes	NIPDAU	Level-1-260C-UNLIM	0 to 70	LS139A
SN74LS139ADR.A	Active	Production	SOIC (D) 16	2500 LARGE T&R	Yes	NIPDAU	Level-1-260C-UNLIM	0 to 70	LS139A
SN74LS139ADRE4	Active	Production	SOIC (D) 16	2500 LARGE T&R	Yes	NIPDAU	Level-1-260C-UNLIM	0 to 70	LS139A
SN74LS139AN	Active	Production	PDIP (N) 16	25 TUBE	Yes	NIPDAU	N/A for Pkg Type	0 to 70	SN74LS139AN
SN74LS139AN.A	Active	Production	PDIP (N) 16	25 TUBE	Yes	NIPDAU	N/A for Pkg Type	0 to 70	SN74LS139AN
SN74LS139ANE4	Active	Production	PDIP (N) 16	25 TUBE	Yes	NIPDAU	N/A for Pkg Type	0 to 70	SN74LS139AN
SN74LS139ANSR	Active	Production	SOP (NS) 16	2000 LARGE T&R	Yes	NIPDAU	Level-1-260C-UNLIM	0 to 70	74LS139A
SN74LS139ANSR.A	Active	Production	SOP (NS) 16	2000 LARGE T&R	Yes	NIPDAU	Level-1-260C-UNLIM	0 to 70	74LS139A
SN74S139AD	Active	Production	SOIC (D) 16	40 TUBE	Yes	NIPDAU	Level-1-260C-UNLIM	0 to 70	S139A
SN74S139AD.A	Active	Production	SOIC (D) 16	40 TUBE	Yes	NIPDAU	Level-1-260C-UNLIM	0 to 70	S139A
SN74S139AN	Active	Production	PDIP (N) 16	25 TUBE	Yes	NIPDAU	N/A for Pkg Type	0 to 70	SN74S139AN
SN74S139AN.A	Active	Production	PDIP (N) 16	25 TUBE	Yes	NIPDAU	N/A for Pkg Type	0 to 70	SN74S139AN
SNJ54LS139AFK	Active	Production	LCCC (FK) 20	55 TUBE	No	SNPB	N/A for Pkg Type	-55 to 125	76007012A SNJ54LS 139AFK
SNJ54LS139AFK.A	Active	Production	LCCC (FK) 20	55 TUBE	No	SNPB	N/A for Pkg Type	-55 to 125	76007012A SNJ54LS 139AFK
SNJ54LS139AJ	Active	Production	CDIP (J) 16	25 TUBE	No	SNPB	N/A for Pkg Type	-55 to 125	7600701EA SNJ54LS139AJ

Orderable part number	Status (1)	Material type (2)	Package Pins	Package qty Carrier	RoHS (3)	Lead finish/ Ball material (4)	MSL rating/ Peak reflow (5)	Op temp (°C)	Part marking (6)
SNJ54LS139AJ.A	Active	Production	CDIP (J) 16	25 TUBE	No	SNPB	N/A for Pkg Type	-55 to 125	7600701EA SNJ54LS139AJ
SNJ54LS139AW	Active	Production	CFP (W) 16	25 TUBE	No	SNPB	N/A for Pkg Type	-55 to 125	7600701FA SNJ54LS139AW
SNJ54LS139AW.A	Active	Production	CFP (W) 16	25 TUBE	No	SNPB	N/A for Pkg Type	-55 to 125	7600701FA SNJ54LS139AW
SNJ54S139J	Active	Production	CDIP (J) 16	25 TUBE	No	SNPB	N/A for Pkg Type	-55 to 125	7700401EA SNJ54S139J
SNJ54S139J.A	Active	Production	CDIP (J) 16	25 TUBE	No	SNPB	N/A for Pkg Type	-55 to 125	7700401EA SNJ54S139J
SNJ54S139W	Active	Production	CFP (W) 16	25 TUBE	No	SNPB	N/A for Pkg Type	-55 to 125	7700401FA SNJ54S139W
SNJ54S139W.A	Active	Production	CFP (W) 16	25 TUBE	No	SNPB	N/A for Pkg Type	-55 to 125	7700401FA SNJ54S139W

(1) **Status:** For more details on status, see our [product life cycle](#).

(2) **Material type:** When designated, preproduction parts are prototypes/experimental devices, and are not yet approved or released for full production. Testing and final process, including without limitation quality assurance, reliability performance testing, and/or process qualification, may not yet be complete, and this item is subject to further changes or possible discontinuation. If available for ordering, purchases will be subject to an additional waiver at checkout, and are intended for early internal evaluation purposes only. These items are sold without warranties of any kind.

(3) **RoHS values:** Yes, No, RoHS Exempt. See the [TI RoHS Statement](#) for additional information and value definition.

(4) **Lead finish/Ball material:** Parts may have multiple material finish options. Finish options are separated by a vertical ruled line. Lead finish/Ball material values may wrap to two lines if the finish value exceeds the maximum column width.

(5) **MSL rating/Peak reflow:** The moisture sensitivity level ratings and peak solder (reflow) temperatures. In the event that a part has multiple moisture sensitivity ratings, only the lowest level per JEDEC standards is shown. Refer to the shipping label for the actual reflow temperature that will be used to mount the part to the printed circuit board.

(6) **Part marking:** There may be an additional marking, which relates to the logo, the lot trace code information, or the environmental category of the part.

Multiple part markings will be inside parentheses. Only one part marking contained in parentheses and separated by a "~" will appear on a part. If a line is indented then it is a continuation of the previous line and the two combined represent the entire part marking for that device.

Important Information and Disclaimer: The information provided on this page represents TI's knowledge and belief as of the date that it is provided. TI bases its knowledge and belief on information provided by third parties, and makes no representation or warranty as to the accuracy of such information. Efforts are underway to better integrate information from third parties. TI has taken and continues to take reasonable steps to provide representative and accurate information but may not have conducted destructive testing or chemical analysis on incoming materials and chemicals. TI and TI suppliers consider certain information to be proprietary, and thus CAS numbers and other limited information may not be available for release.

In no event shall TI's liability arising out of such information exceed the total purchase price of the TI part(s) at issue in this document sold by TI to Customer on an annual basis.

OTHER QUALIFIED VERSIONS OF SN54LS139A, SN54LS139A-SP, SN74LS139A :

- Catalog : [SN74LS139A](#), [SN54LS139A](#)
- Military : [SN54LS139A](#)
- Space : [SN54LS139A-SP](#)

NOTE: Qualified Version Definitions:

- Catalog - TI's standard catalog product
- Military - QML certified for Military and Defense Applications
- Space - Radiation tolerant, ceramic packaging and qualified for use in Space-based application

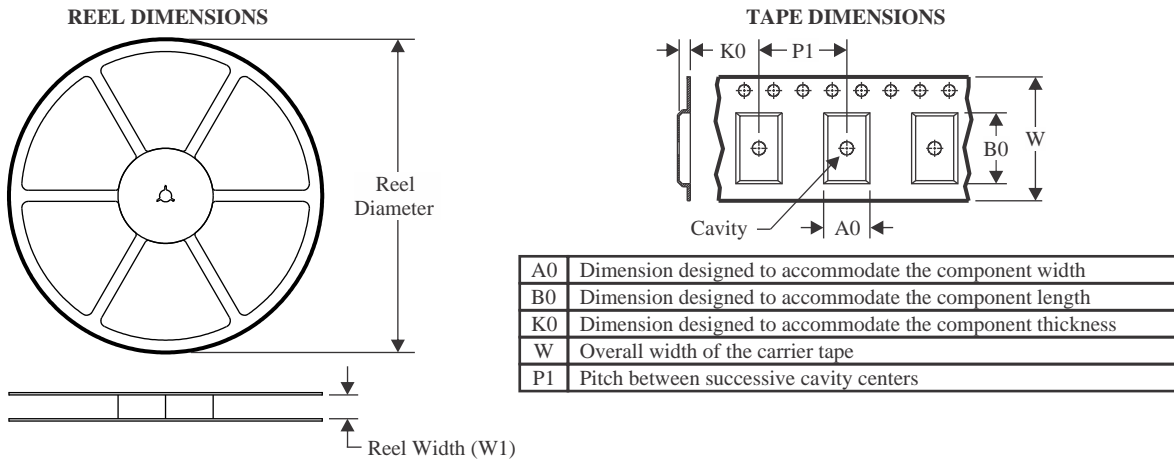
TAPE AND REEL INFORMATION

QUADRANT ASSIGNMENTS FOR PIN 1 ORIENTATION IN TAPE



*All dimensions are nominal

Device	Package Type	Package Drawing	Pins	SPQ	Reel Diameter (mm)	Reel Width W1 (mm)	A0 (mm)	B0 (mm)	K0 (mm)	P1 (mm)	W (mm)	Pin1 Quadrant
SN74LS139ADR	SOIC	D	16	2500	330.0	16.4	6.5	10.3	2.1	8.0	16.0	Q1
SN74LS139ANSR	SOP	NS	16	2000	330.0	16.4	8.2	10.5	2.5	12.0	16.0	Q1

TAPE AND REEL BOX DIMENSIONS

*All dimensions are nominal

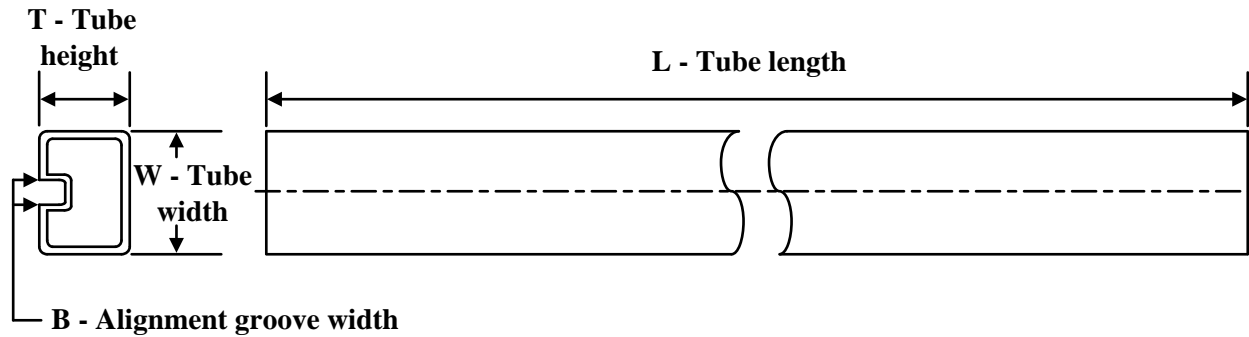
Device	Package Type	Package Drawing	Pins	SPQ	Length (mm)	Width (mm)	Height (mm)
SN74LS139ADR	SOIC	D	16	2500	353.0	353.0	32.0
SN74LS139ANSR	SOP	NS	16	2000	356.0	356.0	35.0

TUBE

*All dimensions are nominal

Device	Package Name	Package Type	Pins	SPQ	L (mm)	W (mm)	T (µm)	B (mm)
76007012A	FK	LCCC	20	55	506.98	12.06	2030	NA
7600701FA	W	CFP	16	25	506.98	26.16	6220	NA
JM38510/30702B2A	FK	LCCC	20	55	506.98	12.06	2030	NA
JM38510/30702B2A.A	FK	LCCC	20	55	506.98	12.06	2030	NA
JM38510/30702BF2A	W	CFP	16	25	506.98	26.16	6220	NA
JM38510/30702BF2A.A	W	CFP	16	25	506.98	26.16	6220	NA
JM38510/30702SF2A	W	CFP	16	25	506.98	26.16	6220	NA
JM38510/30702SF2A.A	W	CFP	16	25	506.98	26.16	6220	NA
M38510/30702B2A	FK	LCCC	20	55	506.98	12.06	2030	NA
M38510/30702BF2A	W	CFP	16	25	506.98	26.16	6220	NA
M38510/30702SF2A	W	CFP	16	25	506.98	26.16	6220	NA
SN74LS139AN	N	PDIP	16	25	506	13.97	11230	4.32
SN74LS139AN	N	PDIP	16	25	506	13.97	11230	4.32
SN74LS139AN.A	N	PDIP	16	25	506	13.97	11230	4.32
SN74LS139AN.A	N	PDIP	16	25	506	13.97	11230	4.32
SN74LS139ANE4	N	PDIP	16	25	506	13.97	11230	4.32
SN74LS139ANE4	N	PDIP	16	25	506	13.97	11230	4.32
SN74S139AD	D	SOIC	16	40	507	8	3940	4.32
SN74S139AD.A	D	SOIC	16	40	507	8	3940	4.32
SN74S139AN	N	PDIP	16	25	506	13.97	11230	4.32
SN74S139AN	N	PDIP	16	25	506	13.97	11230	4.32
SN74S139AN.A	N	PDIP	16	25	506	13.97	11230	4.32
SN74S139AN.A	N	PDIP	16	25	506	13.97	11230	4.32
SNJ54LS139AFK	FK	LCCC	20	55	506.98	12.06	2030	NA
SNJ54LS139AFK.A	FK	LCCC	20	55	506.98	12.06	2030	NA
SNJ54LS139AW	W	CFP	16	25	506.98	26.16	6220	NA
SNJ54LS139AW.A	W	CFP	16	25	506.98	26.16	6220	NA



PACKAGE OUTLINE

NS0016A

SOP - 2.00 mm max height

SOP

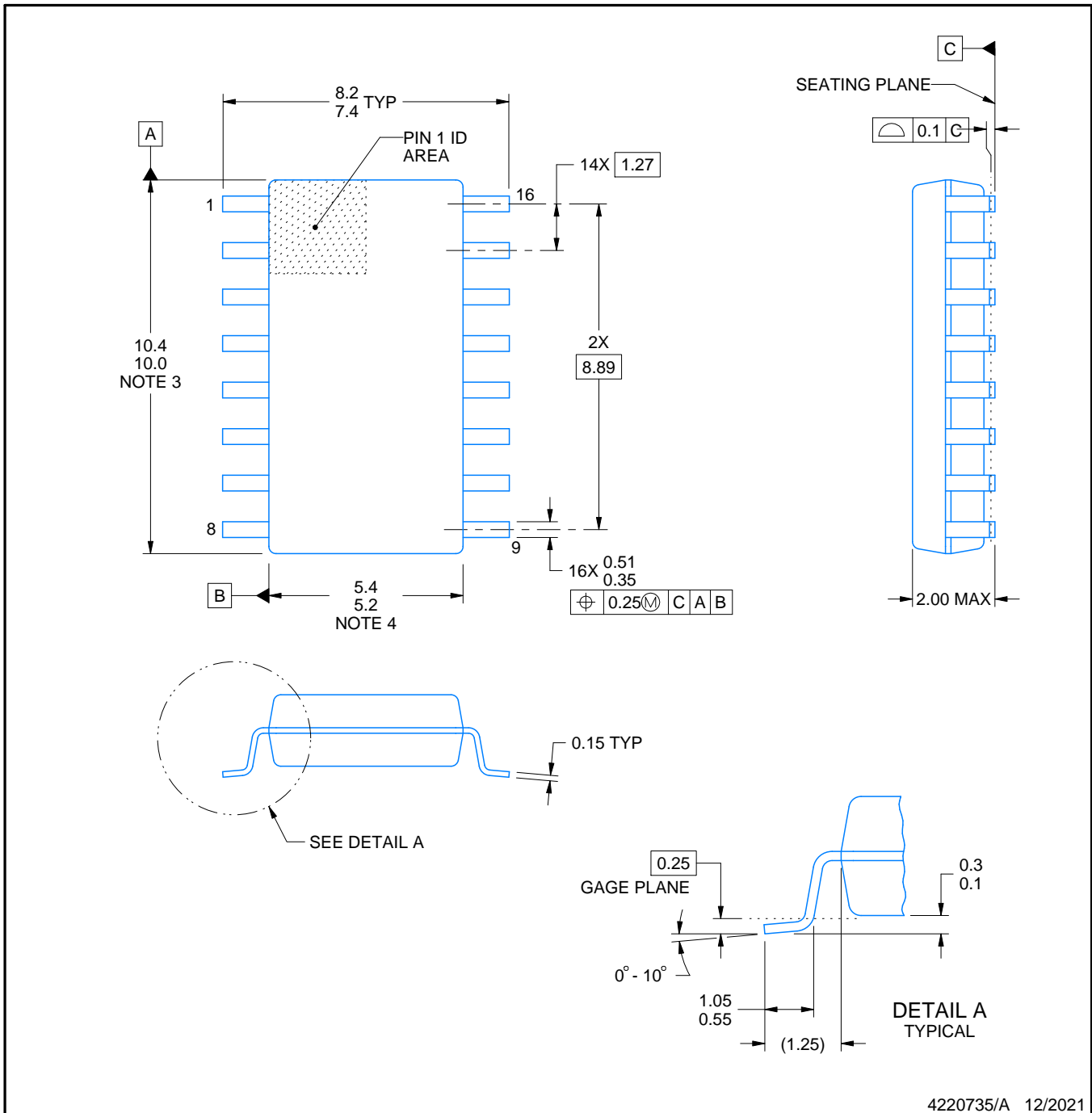

4220735/A 12/2021

NOTES:

1. All linear dimensions are in millimeters. Dimensions in parenthesis are for reference only. Dimensioning and tolerancing per ASME Y14.5M.
2. This drawing is subject to change without notice.
3. This dimension does not include mold flash, protrusions, or gate burrs. Mold flash, protrusions, or gate burrs shall not exceed 0.15 mm, per side.
4. This dimension does not include interlead flash. Interlead flash shall not exceed 0.25 mm, per side.

EXAMPLE BOARD LAYOUT

NS0016A

SOP - 2.00 mm max height

SOP

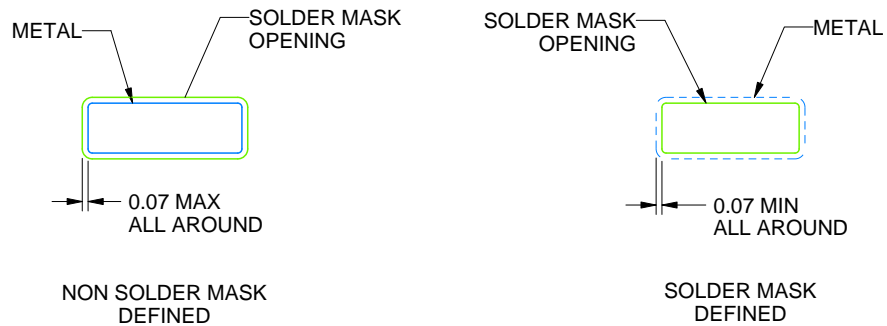

4220735/A 12/2021

NOTES: (continued)

5. Publication IPC-7351 may have alternate designs.

6. Solder mask tolerances between and around signal pads can vary based on board fabrication site.

EXAMPLE STENCIL DESIGN

NS0016A

SOP - 2.00 mm max height

SOP

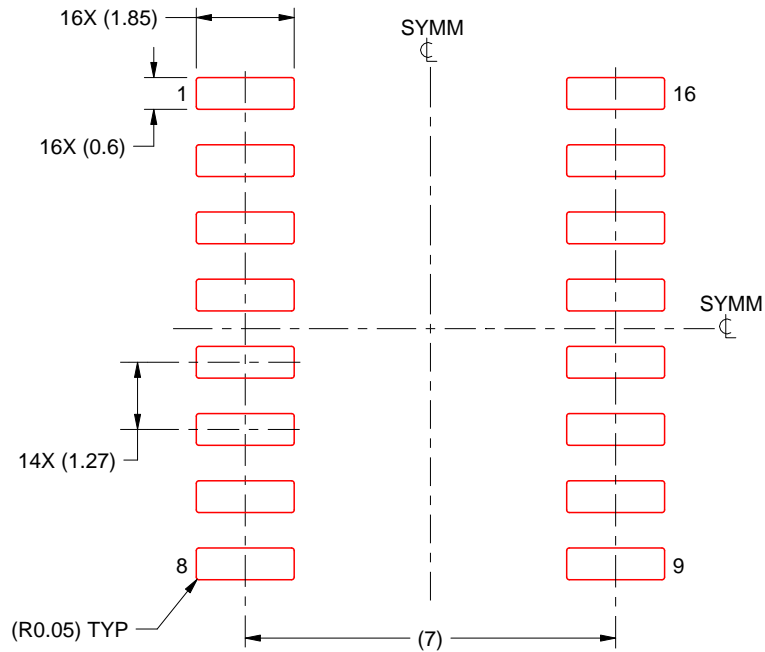

SOLDER PASTE EXAMPLE
BASED ON 0.125 mm THICK STENCIL
SCALE:7X

4220735/A 12/2021

NOTES: (continued)

7. Laser cutting apertures with trapezoidal walls and rounded corners may offer better paste release. IPC-7525 may have alternate design recommendations.
8. Board assembly site may have different recommendations for stencil design.

MECHANICAL DATA

NS (R-PDSO-G**)

PLASTIC SMALL-OUTLINE PACKAGE

14-PINS SHOWN



- NOTES:
- A. All linear dimensions are in millimeters.
 - B. This drawing is subject to change without notice.
 - C. Body dimensions do not include mold flash or protrusion, not to exceed 0,15.

W (R-GDFP-F16)

CERAMIC DUAL FLATPACK



- NOTES:
- A. All linear dimensions are in inches (millimeters).
 - B. This drawing is subject to change without notice.
 - C. This package can be hermetically sealed with a ceramic lid using glass frit.
 - D. Index point is provided on cap for terminal identification only.
 - E. Falls within MIL STD 1835 GDFP2-F16

GENERIC PACKAGE VIEW

FK 20

LCCC - 2.03 mm max height

8.89 x 8.89, 1.27 mm pitch

LEADLESS CERAMIC CHIP CARRIER

This image is a representation of the package family, actual package may vary.
Refer to the product data sheet for package details.

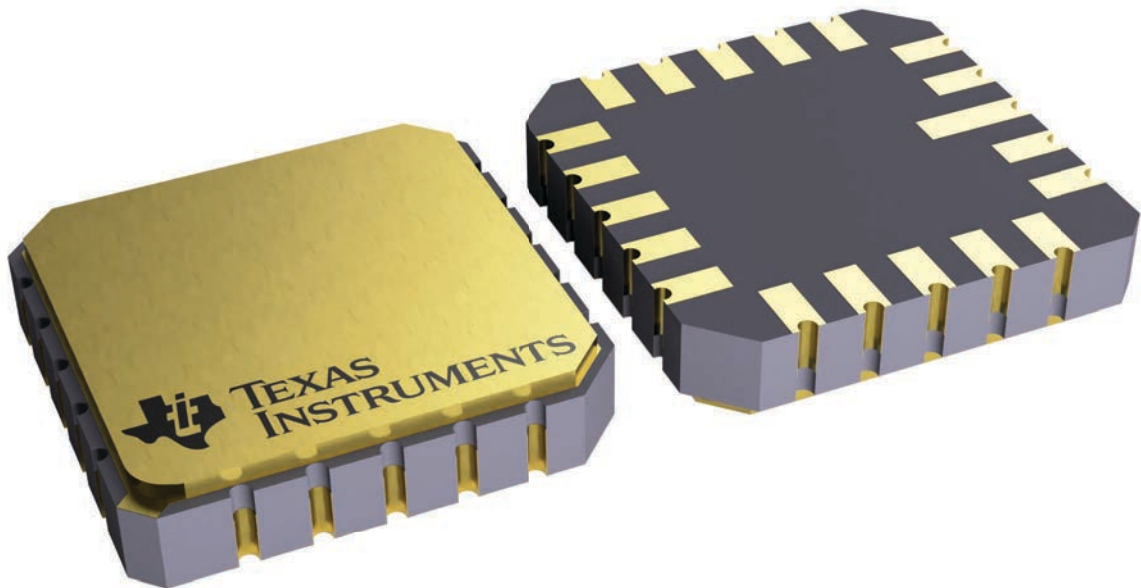

4229370VA\

J (R-GDIP-T**)

14 LEADS SHOWN

CERAMIC DUAL IN-LINE PACKAGE



DIM \ PINS **	14	16	18	20
A	0.300 (7,62) BSC	0.300 (7,62) BSC	0.300 (7,62) BSC	0.300 (7,62) BSC
B MAX	0.785 (19,94)	.840 (21,34)	0.960 (24,38)	1.060 (26,92)
B MIN	—	—	—	—
C MAX	0.300 (7,62)	0.300 (7,62)	0.310 (7,87)	0.300 (7,62)
C MIN	0.245 (6,22)	0.245 (6,22)	0.220 (5,59)	0.245 (6,22)



4040083/F 03/03

- NOTES:
- All linear dimensions are in inches (millimeters).
 - This drawing is subject to change without notice.
 - This package is hermetically sealed with a ceramic lid using glass frit.
 - Index point is provided on cap for terminal identification only on press ceramic glass frit seal only.
 - Falls within MIL STD 1835 GDIP1-T14, GDIP1-T16, GDIP1-T18 and GDIP1-T20.

N (R-PDIP-T**)

PLASTIC DUAL-IN-LINE PACKAGE

16 PINS SHOWN



- NOTES:
- A. All linear dimensions are in inches (millimeters).
 - B. This drawing is subject to change without notice.
 - Falls within JEDEC MS-001, except 18 and 20 pin minimum body length (Dim A).
 - The 20 pin end lead shoulder width is a vendor option, either half or full width.

IMPORTANT NOTICE AND DISCLAIMER

TI PROVIDES TECHNICAL AND RELIABILITY DATA (INCLUDING DATA SHEETS), DESIGN RESOURCES (INCLUDING REFERENCE DESIGNS), APPLICATION OR OTHER DESIGN ADVICE, WEB TOOLS, SAFETY INFORMATION, AND OTHER RESOURCES "AS IS" AND WITH ALL FAULTS, AND DISCLAIMS ALL WARRANTIES, EXPRESS AND IMPLIED, INCLUDING WITHOUT LIMITATION ANY IMPLIED WARRANTIES OF MERCHANTABILITY, FITNESS FOR A PARTICULAR PURPOSE OR NON-INFRINGEMENT OF THIRD PARTY INTELLECTUAL PROPERTY RIGHTS.

These resources are intended for skilled developers designing with TI products. You are solely responsible for (1) selecting the appropriate TI products for your application, (2) designing, validating and testing your application, and (3) ensuring your application meets applicable standards, and any other safety, security, regulatory or other requirements.

These resources are subject to change without notice. TI grants you permission to use these resources only for development of an application that uses the TI products described in the resource. Other reproduction and display of these resources is prohibited. No license is granted to any other TI intellectual property right or to any third party intellectual property right. TI disclaims responsibility for, and you will fully indemnify TI and its representatives against, any claims, damages, costs, losses, and liabilities arising out of your use of these resources.

TI's products are provided subject to [TI's Terms of Sale](#) or other applicable terms available either on [ti.com](https://www.ti.com) or provided in conjunction with such TI products. TI's provision of these resources does not expand or otherwise alter TI's applicable warranties or warranty disclaimers for TI products.

TI objects to and rejects any additional or different terms you may have proposed.

Mailing Address: Texas Instruments, Post Office Box 655303, Dallas, Texas 75265

Copyright © 2025, Texas Instruments Incorporated