

TMAG511x-Q1 2D, Dual-Channel, High-Sensitivity, Hall-Effect Latch

1 Features

- AEC-Q100 qualified with the following results:
 - Device temperature grade 1: –40°C to 125°C ambient operating temperature range
 - Device HBM ESD classification Level H3A
 - Device CDM ESD classification Level C6
- [Functional Safety-Capable](#)
 - [Documentation available to aid functional safety system design](#)
- 2D sensing with planar and vertical hall sensors
- Inherent quadrature independent of magnet alignment or magnet pole pitch
- Two functional options available:
 - TMAG5110-Q1: independent 2D outputs
 - TMAG5111-Q1: speed and direction outputs
- Ultra-high magnetic sensitivity:
 - TMAG511x2-Q1: ±1.4mT (typical)
 - TMAG511x4-Q1: ±3mT (typical)
- Fast 40kHz sensing bandwidth
- 2.5V to 38V operating V_{CC} range
- Open-drain output (10mA sink)
- Wide ambient operating temperature range:
 - –40°C to +125°C
- **Protection features**
 - Reverse supply protection (up to –20V)
 - Device survives up to 40V
 - Output short-circuit protection
 - Output current limitation

2 Applications

- Incremental rotary encoding
- Linear speed and direction control
 - [Roof](#) and [trunk](#) motor control
 - [Window](#) and [door](#) motor control
- Angular position detection
 - Knob control (radio and climate control)
 - [Electronic power steering](#)
 - Fluid measurement
- Angular speed and direction
 - [Electric pumps](#)
 - [Fans](#)
 - Wheel and motor speed

3 Description

The TMAG5110-Q1 and TMAG5111-Q1 are 2-dimensional, dual Hall-effect latches operating from a 2.5V to 38V power supply. Designed for high-speed and high-temperature motor applications, these devices are optimized for applications leveraging rotating magnets. Integrating two sensors and two separate signal chains the TMAG511x-Q1 offers two independent digital outputs giving speed and direction calculation (TMAG5111-Q1) or giving directly the digital output of each independent latches (TMAG5110-Q1). This high level of integration allows the use of a single TMAG511x-Q1 device instead of two separate latches.

The device is offered in a standard 3mT operating point, as well as a high-sensitivity 1.4mT operating point. The higher magnetic sensitivity provides flexibility in low-cost magnet selection and mechanical component placement. The TMAG511x-Q1 is also available in three 2-axis combination options (X-Y, Z-X, Z-Y) to allow flexible placement of the sensor relative to the magnet.

The device performs consistently across a wide ambient temperature range of –40°C to +125°C.

Package Information

PART NUMBER	PACKAGE ⁽¹⁾	PACKAGE SIZE ⁽²⁾
TMAG5110-Q1	DBV (SOT-23, 5)	2.9mm × 2.8mm
TMAG5111-Q1		

- (1) For all available packages, see the package option addendum at the end of the data sheet.
- (2) The package size (length × width) is a nominal value and includes pins, where applicable.



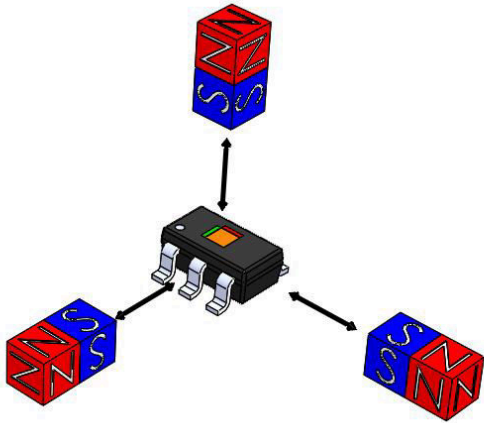

Device Axis Polarities

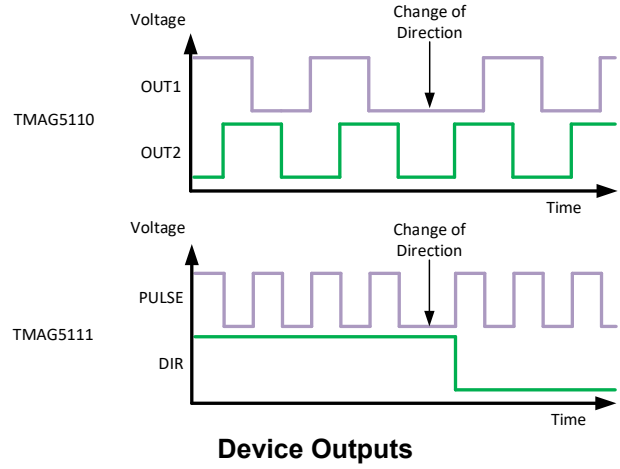

Table of Contents

1 Features	1	7.4 Device Functional Modes.....	32
2 Applications	1	8 Application and Implementation	33
3 Description	1	8.1 Application Information.....	33
4 Device Comparison Table	3	8.2 Typical Applications.....	33
5 Pin Configuration and Functions	4	8.3 Power Supply Recommendations.....	35
6 Specifications	5	8.4 Layout.....	35
6.1 Absolute Maximum Ratings	5	9 Device and Documentation Support	36
6.2 ESD Ratings	5	9.1 Device Support.....	36
6.3 Recommended Operating Conditions	5	9.2 Receiving Notification of Documentation Updates....	36
6.4 Thermal Information	5	9.3 Support Resources.....	36
6.5 Electrical Characteristics	6	9.4 Trademarks.....	36
6.6 Magnetic Characteristics	6	9.5 Electrostatic Discharge Caution.....	36
6.7 Typical Characteristics.....	7	9.6 Glossary.....	36
7 Detailed Description	21	10 Revision History	37
7.1 Overview.....	21	11 Mechanical, Packaging, and Orderable Information	37
7.2 Functional Block Diagram.....	21		
7.3 Feature Description.....	21		

4 Device Comparison Table

DEVICE	DEVICE OPTION	SENSITIVITY (BOP TYP)	AXIS OF SENSITIVITY	OUT1	OUT2
TMAG5110-Q1	A2	1.4 mT	XY	X	Y
	A4	3 mT			
	B2	1.4 mT	ZX	Z	X
	B4	3 mT			
	C2	1.4 mT	ZY	Z	Y
	C4	3 mT			
TMAG5111-Q1	A2	1.4 mT	XY	Speed	Direction
	A4	3 mT			
	B2	1.4 mT	ZX		
	B4	3 mT			
	C2	1.4 mT	ZY		
	C4	3 mT			

5 Pin Configuration and Functions

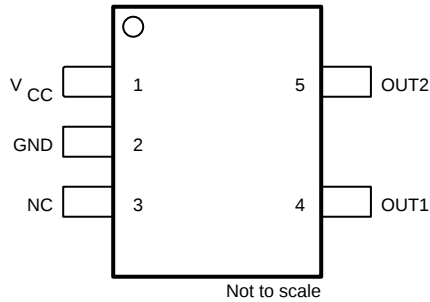
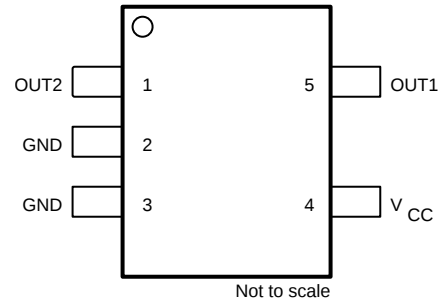

Figure 5-1. DBV Package, 5-Pin SOT-23 Version A (Top View)



NOTE: Version R is Product Preview only
Figure 5-2. DBV Package, 5-Pin SOT-23 Version R (Top View)

Table 5-1. Pin Functions

Name	PIN		TYPE	DESCRIPTION
	SOT-23 VERSION A	SOT-23 VERSION R ⁽¹⁾		
GND	2	2, 3	Ground	Ground reference.
NC	3	—	—	Not internally connected. Connection to the ground pin is recommended.
OUT1	4	5	Output	Open-drain output 1. For TMAG5110A-Q1: X axis. For TMAG5110B-Q1: Z axis. For TMAG5110C-Q1: Z axis. For TMAG5111-Q1: Speed.
OUT2	5	1	Output	Open-drain output 2. For TMAG5110A-Q1: Y axis. For TMAG5110B-Q1: X axis. For TMAG5110C-Q1: Y axis. For TMAG5111-Q1: Direction.
V _{CC}	1	4	Power supply	2.5-V to 38-V power supply. Connect a ceramic capacitor with a value of at least 0.01 µF between V _{CC} and ground.

(1) Preview information (not Production Data)

6 Specifications

6.1 Absolute Maximum Ratings

over operating free-air temperature range (unless otherwise noted)⁽¹⁾

		MIN	MAX	UNIT
Power Supply Voltage	V _{CC}	-20	40	V
	Voltage ramp rate (V _{CC} < 5V)	Unlimited		V/μs
	Voltage ramp rate (V _{CC} > 5V)	0	2	
Output Pin Voltage	V _{OUT1} , V _{OUT2}	GND – 0.5	40	V
Output pin reverse current during reverse supply condition		0	100	mA
Magnetic flux density, B _{MAX}		Unlimited		T
Junction temperature, T _J	Junction temperature, T _J	-40	150	°C
Storage temperature, T _{stg}		-65	150	°C

- (1) Stresses beyond those listed under *Absolute Maximum Rating* may cause permanent damage to the device. These are stress ratings only, which do not imply functional operation of the device at these or any other conditions beyond those indicated under *Recommended Operating Condition*. Exposure to absolute-maximum-rated conditions for extended periods may affect device reliability.

6.2 ESD Ratings

			VALUE	UNIT
V _(ESD)	Electrostatic discharge	Human body model (HBM), per AEC Q100-002 ⁽¹⁾ HBM ESD Classification Level 2	±2000	V
		Charged device model (CDM), per AEC Q100-011 CDM ESD Classification Level C4A	± 500	V

- (1) AECQ 100-002 indicates that HBM stressing shall be in accordance with the ANSI/ESDA/JEDEC JS-001 specification.

6.3 Recommended Operating Conditions

over operating free-air temperature range (unless otherwise noted)

		MIN	MAX	UNIT
V _{CC}	Power supply voltage	2.5	38	V
VO	Output pin voltage (OUT1, OUT2)	0	38	V
ISINK	Output pin current sink (OUT1, OUT2) ⁽¹⁾	0	10	mA
T _A	Ambient temperature	-40	125	°C

- (1) Power dissipation and thermal limits must be observed

6.4 Thermal Information

THERMAL METRIC ⁽¹⁾		TMAG5110	UNIT
		DBV (SOT-23)	
		5 PINS	
R _{θJA}	Junction-to-ambient thermal resistance	166.5	°C/W
R _{θJC(top)}	Junction-to-case (top) thermal resistance	86.0	
R _{θJB}	Junction-to-board thermal resistance	37.6	
Ψ _{JT}	Junction-to-top characterization parameter	14.1	
Ψ _{JB}	Junction-to-board characterization parameter	37.3	
R _{θJC(bot)}	Junction-to-case (bottom) thermal resistance	—	°C/W

- (1) For more information about traditional and new thermal metrics, see the [Semiconductor and IC Package Thermal Metrics](#) application report.

6.5 Electrical Characteristics

over operating free-air temperature range (unless otherwise noted)

PARAMETER		TEST CONDITIONS	MIN	TYP	MAX	UNIT
POWER SUPPLY						
I_{CC}	Operating supply current for TMAG511xx2-Q1	$V_{CC} = 2.5\text{ V to }38\text{ V}$, $T_A = -40^\circ\text{C to }125^\circ\text{C}$		6	8	mA
I_{CC}	Operating supply current for TMAG511xx4-Q1	$V_{CC} = 2.5\text{ V to }38\text{ V}$, $T_A = -40^\circ\text{C to }125^\circ\text{C}$		6	8.5	mA
I_{RCC}	Reverse-battery current	$V_{CC} = -20\text{ V}$	-100			μA
t_{ON}	Power-on-time			52.5		μs
OUTPUT						
V_{OL}	Low-level output voltage	$I_{OL} = 10\text{mA}$	0		0.5	V
I_{OH}	Output leakage current	$V_{CC} = 5\text{V}$		0.1	1	μA
I_{SC}	Output short-circuit current			65	110	mA
t_{PD}	Propagation delay time	Change in B_{OP} or B_{RP} to change in output		12.5		μs
t_R	Output rise time	$R_L = 1\text{k}\Omega$, $C_L = 50\text{pF}$		0.2		
t_F	Output fall time	$R_L = 1\text{k}\Omega$, $C_L = 50\text{pF}$		0.2		
FREQUENCY RESPONSE						
f_{CHOP}	Chopping frequency			320		kHz
f_{BW}	Signal bandwidth			40		kHz

6.6 Magnetic Characteristics

over operating free-air temperature range (unless otherwise noted)

PARAMETER		TEST CONDITIONS	MIN	TYP	MAX	UNIT
TMAG5110x2-Q1						
$B_{OP(1)}$, $B_{OP(2)}$	Magnetic field operating point	$V_{CC} = 2.5\text{ V to }38\text{ V}$, $T_A = -40^\circ\text{C to }125^\circ\text{C}$	0.2	1.4	2.6	mT
$B_{RP(1)}$, $B_{RP(2)}$	Magnetic field release point		-2.6	-1.4	-0.2	
$B_{HYS(1)}$, $B_{HYS(2)}$	Magnetic hysteresis $B_{OP} - B_{RP}$		0.9	2.75	4.6	
$B_{SYM(1)}$, $B_{SYM(2)}$	Symmetry	$B_{OP(1)} + B_{RP(1)}$, $B_{OP(2)} + B_{RP(2)}$	-2		2	mT
B_{SYM_OP}	Operating point symmetry	$B_{OP(1)} - B_{OP(2)}$	-1.5		1.5	
B_{SYM_RP}	Release point symmetry	$B_{RP(1)} - B_{RP(2)}$	-1.5		1.5	
TMAG5110x4-Q1						
$B_{OP(1)}$, $B_{OP(2)}$	Magnetic field operating point	$V_{CC} = 2.5\text{ V to }38\text{ V}$, $T_A = -40^\circ\text{C to }125^\circ\text{C}$	0.8	3	5.3	mT
$B_{RP(1)}$, $B_{RP(2)}$	Magnetic field release point		-5.3	-3	-0.8	
$B_{HYS(1)}$, $B_{HYS(2)}$	Magnetic hysteresis $B_{OP} - B_{RP}$		3	6	9	
$B_{SYM(1)}$, $B_{SYM(2)}$	Symmetry	$B_{OP(1)} + B_{RP(1)}$, $B_{OP(2)} + B_{RP(2)}$	-2		2	mT
B_{SYM_OP}	Operating point symmetry	$B_{OP(1)} - B_{OP(2)}$	-1.5		1.5	
B_{SYM_RP}	Release point symmetry	$B_{RP(1)} - B_{RP(2)}$	-1.5		1.5	

6.7 Typical Characteristics

TMAG511xx2-Q1 versions

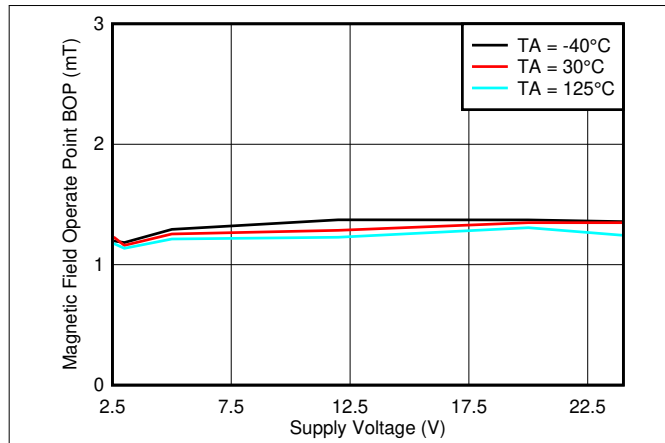

Figure 6-1. B_{OP_Z} Threshold vs V_{CC}

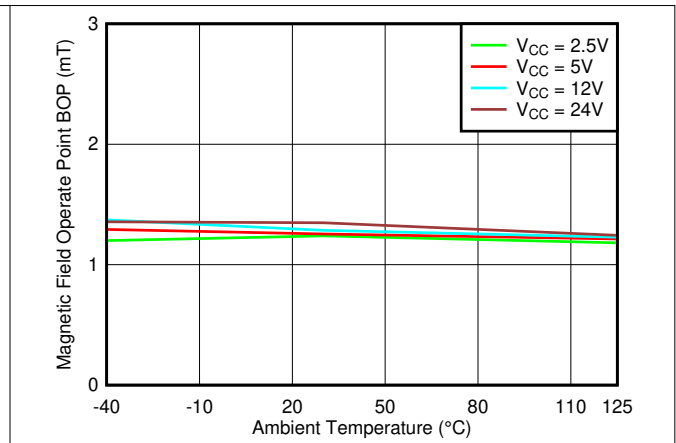

Figure 6-2. B_{OP_Z} Threshold vs Temperature

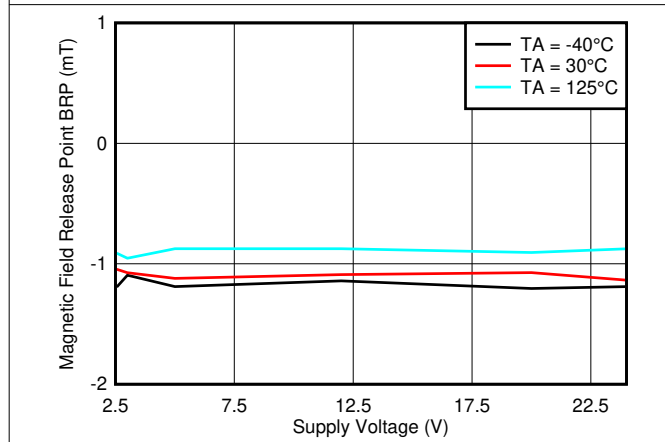

Figure 6-3. B_{RP_Z} Threshold vs V_{CC}

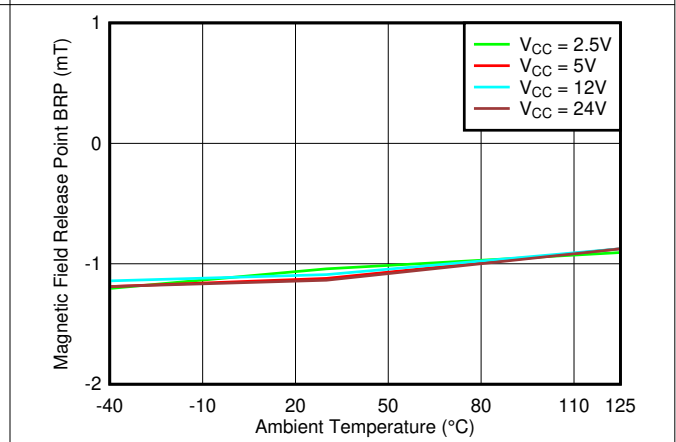

Figure 6-4. B_{RP_Z} Threshold vs Temperature

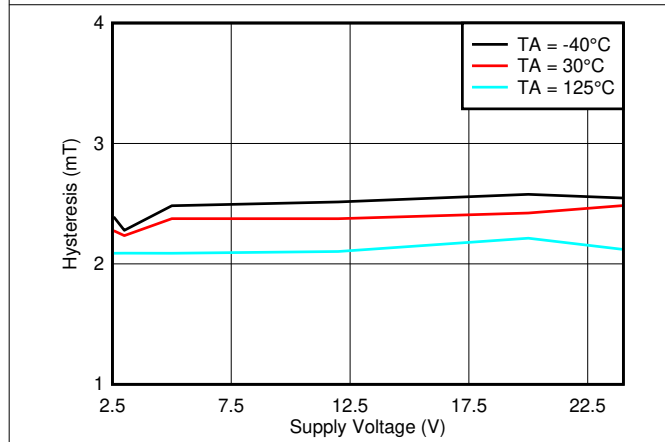

Figure 6-5. Hysteresis_Z vs V_{CC}

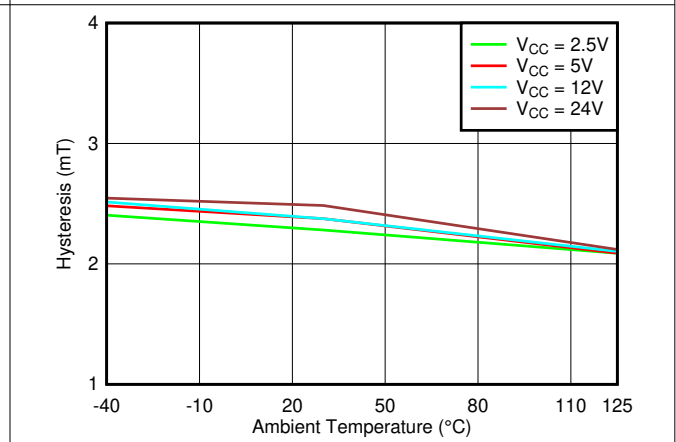

Figure 6-6. Hysteresis_Z vs Temperature

6.7 Typical Characteristics (continued)

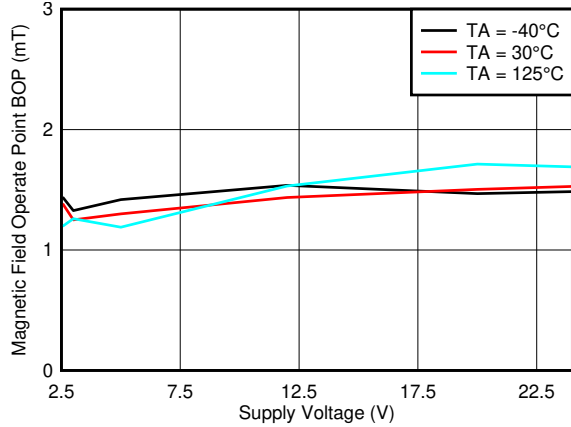

Figure 6-7. BOP_X Threshold vs V_{CC}

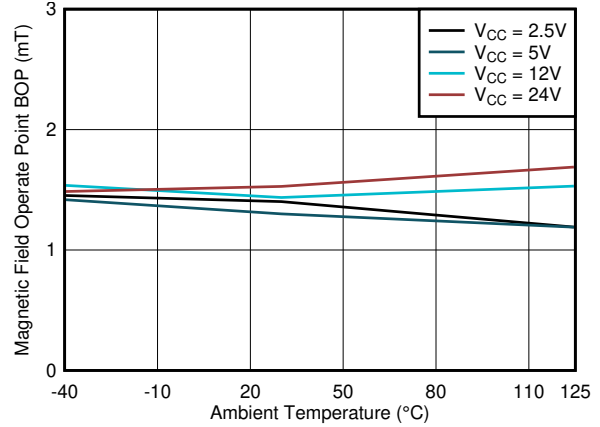

Figure 6-8. BOP_X Threshold vs Temperature

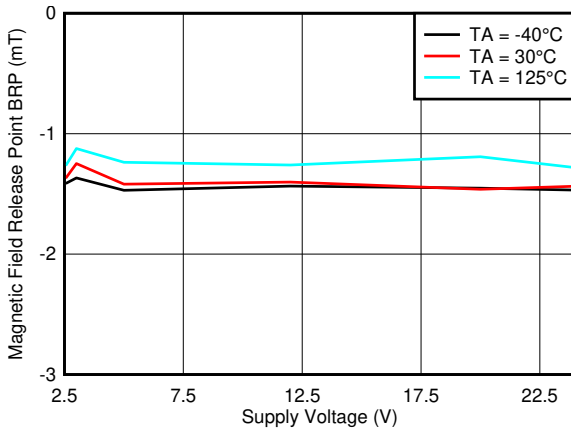

Figure 6-9. BRP_X Threshold vs V_{CC}

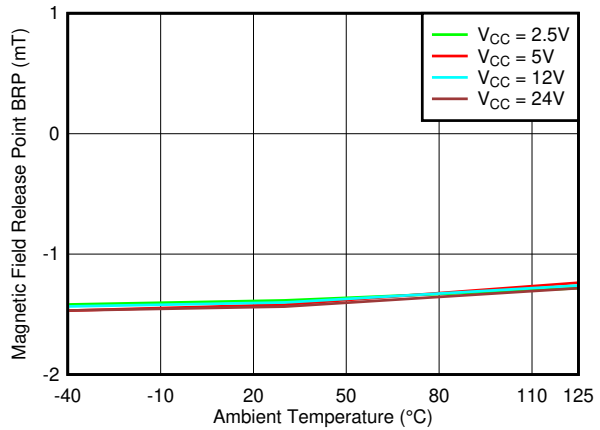

Figure 6-10. BRP_X Threshold vs Temperature

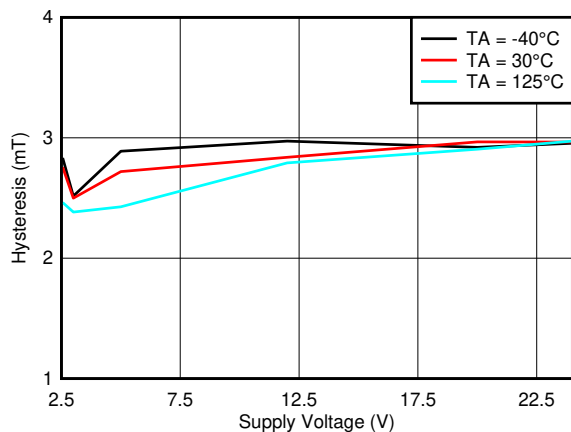

Figure 6-11. Hysteresis_X vs V_{CC}

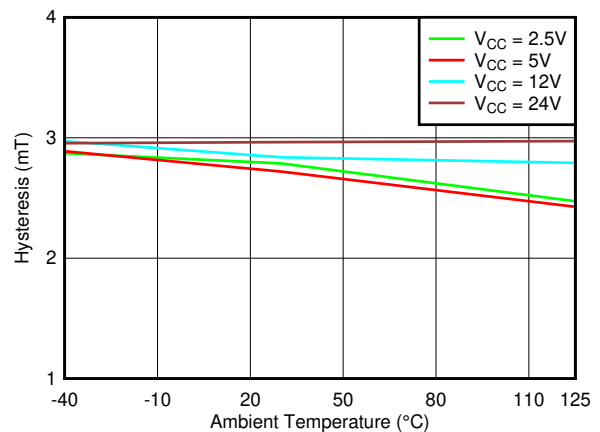

Figure 6-12. Hysteresis_X vs Temperature

6.7 Typical Characteristics (continued)

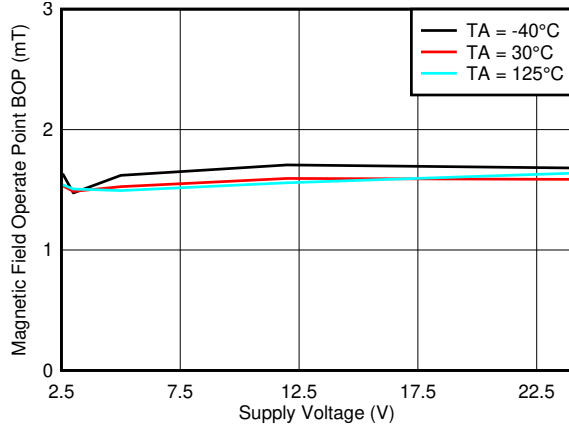

Figure 6-13. B_{OP_Y} Threshold vs V_{CC}

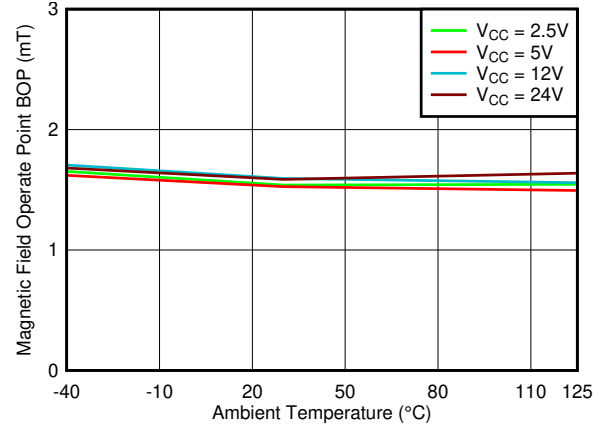

Figure 6-14. B_{OP_Y} Threshold vs Temperature

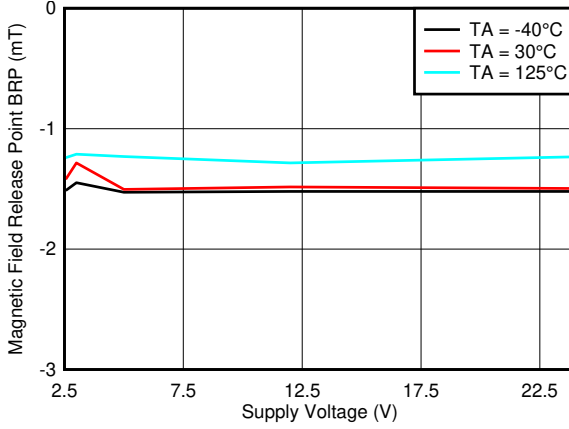

Figure 6-15. B_{RP_Y} Threshold vs V_{CC}

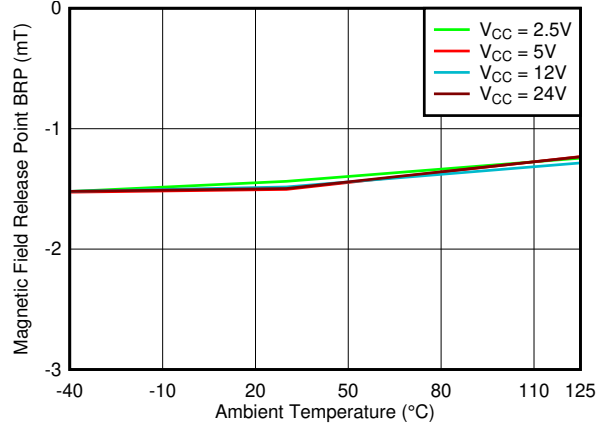

Figure 6-16. B_{RP_Y} Threshold vs Temperature

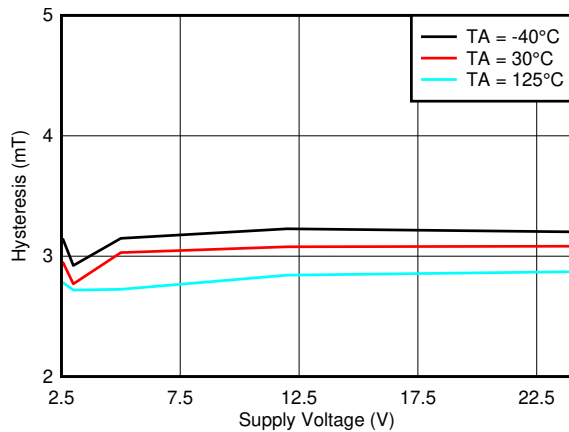

Figure 6-17. Hysteresis_Y vs V_{CC}

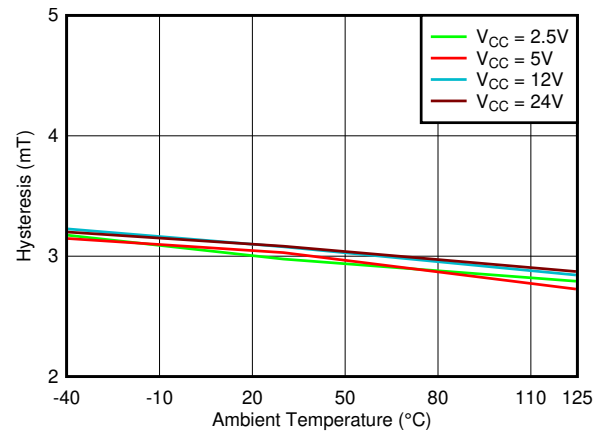

Figure 6-18. Hysteresis_Y vs Temperature

6.7 Typical Characteristics (continued)

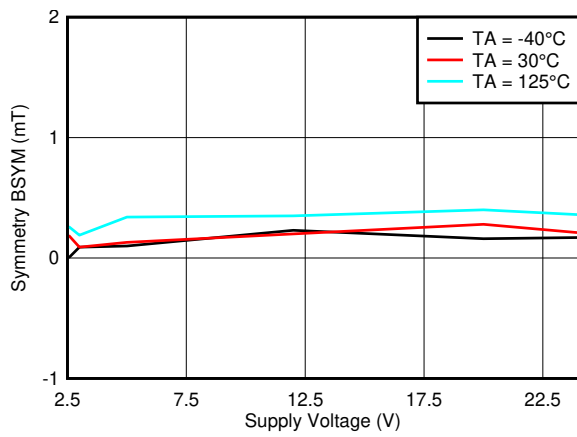

Figure 6-19. $B_{SYM(Z)}$ vs V_{CC}

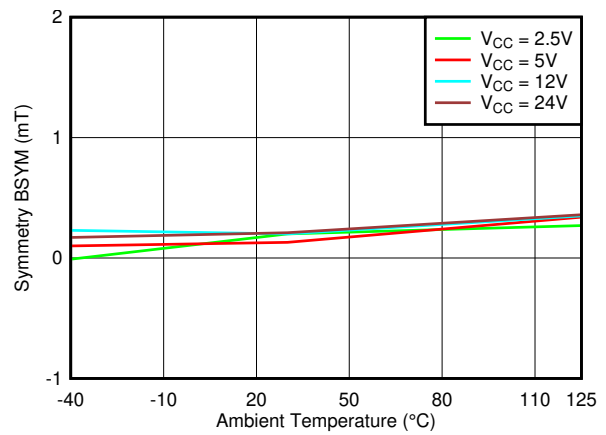

Figure 6-20. $B_{SYM(Z)}$ vs Temperature

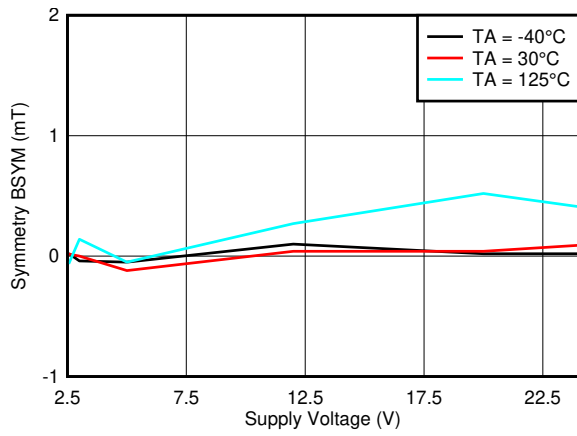

Figure 6-21. $B_{SYM(X)}$ vs V_{CC}

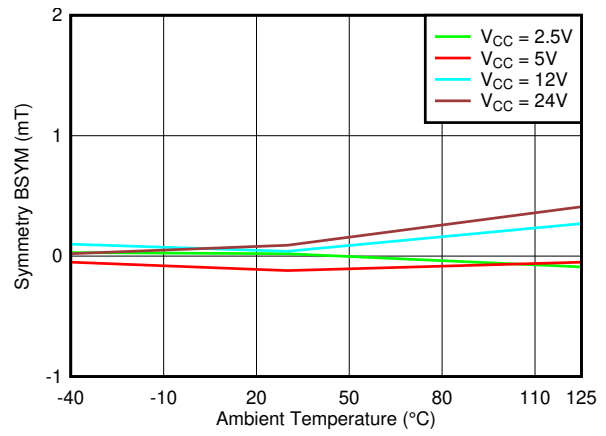

Figure 6-22. $B_{SYM(X)}$ vs Temperature

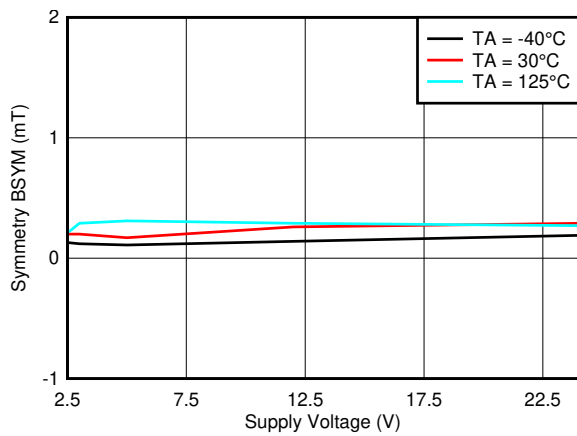

Figure 6-23. $B_{SYM(Y)}$ vs V_{CC}

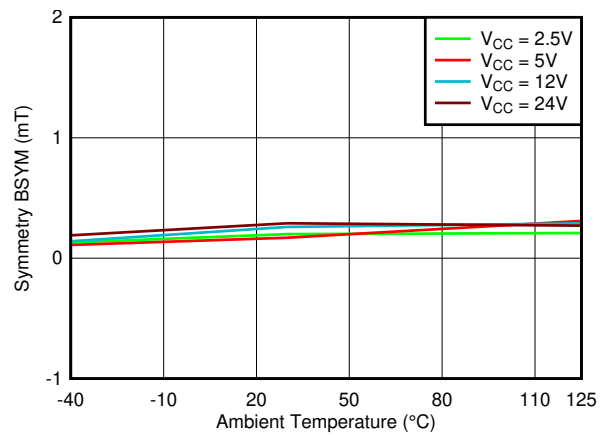

Figure 6-24. $B_{SYM(Y)}$ vs Temperature

6.7 Typical Characteristics (continued)

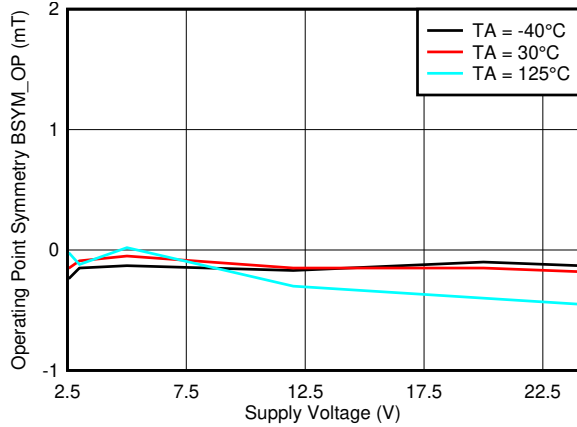

Figure 6-25. $B_{SYM_OP(ZX)}$ vs V_{CC}

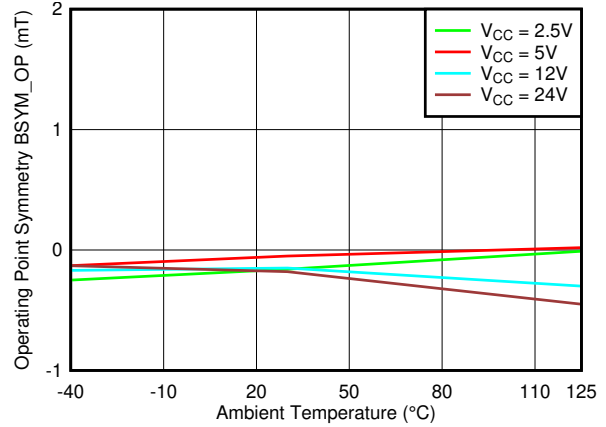

Figure 6-26. $B_{SYM_OP(ZX)}$ vs Temperature

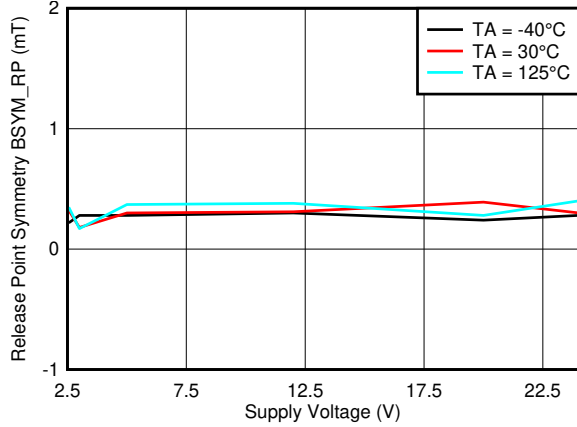

Figure 6-27. $B_{SYM_RP(ZX)}$ vs V_{CC}

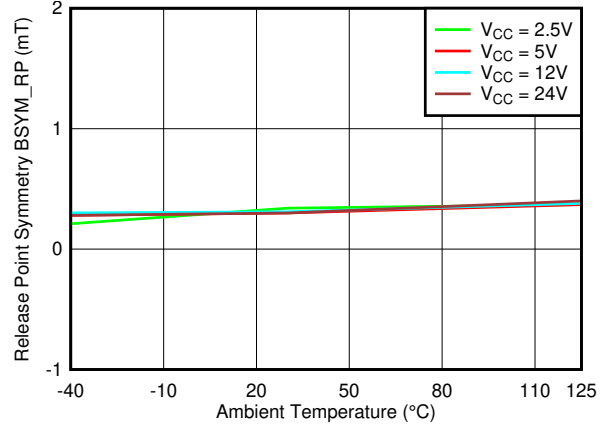

Figure 6-28. $B_{SYM_RP(ZX)}$ vs Temperature

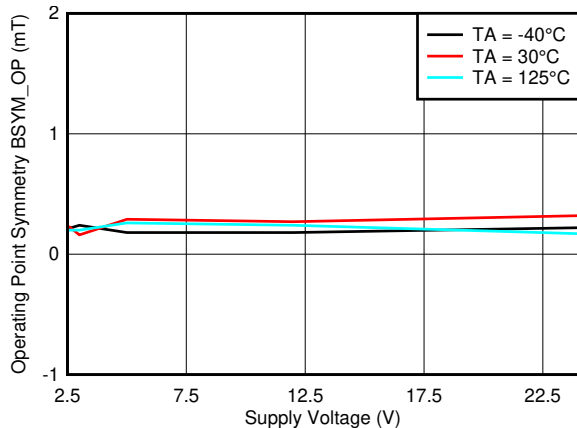

Figure 6-29. $B_{SYM_OP(ZY)}$ vs V_{CC}

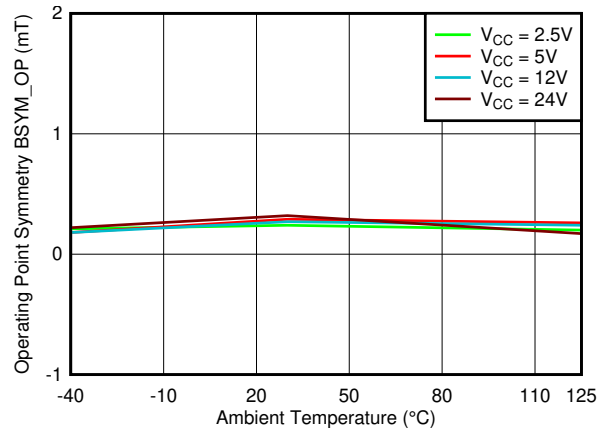

Figure 6-30. $B_{SYM_OP(ZY)}$ vs Temperature

6.7 Typical Characteristics (continued)

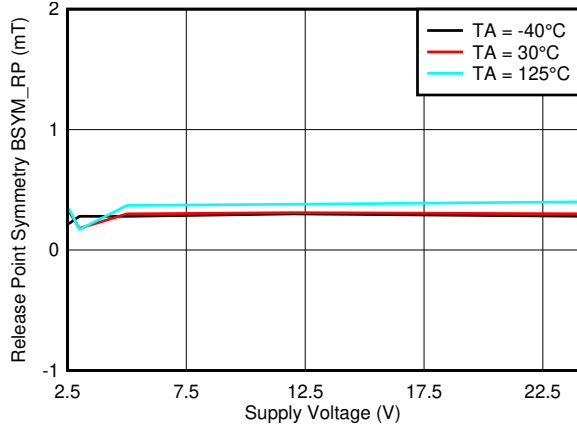

Figure 6-31. $B_{SYM_RP(ZY)}$ vs V_{CC}

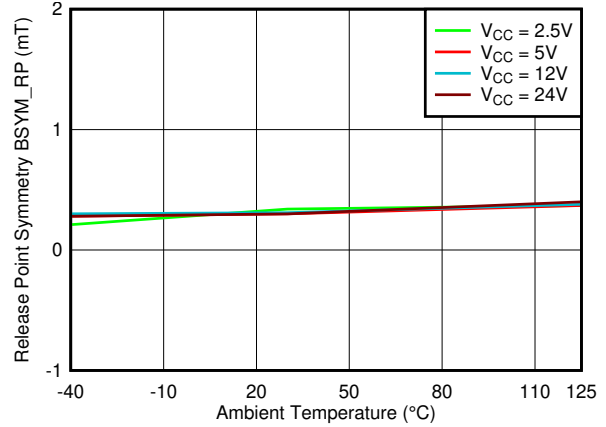

Figure 6-32. $B_{SYM_RP(ZY)}$ vs Temperature

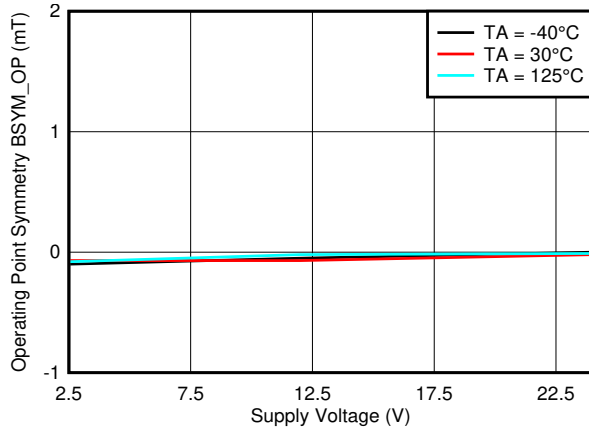

Figure 6-33. $B_{SYM_OP(XY)}$ vs V_{CC}

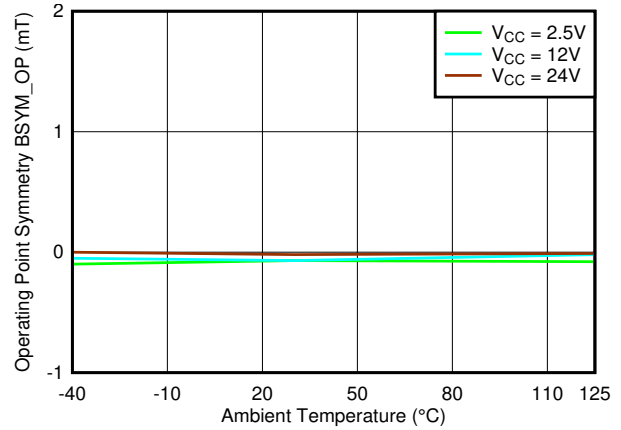

Figure 6-34. $B_{SYM_OP(XY)}$ vs Temperature

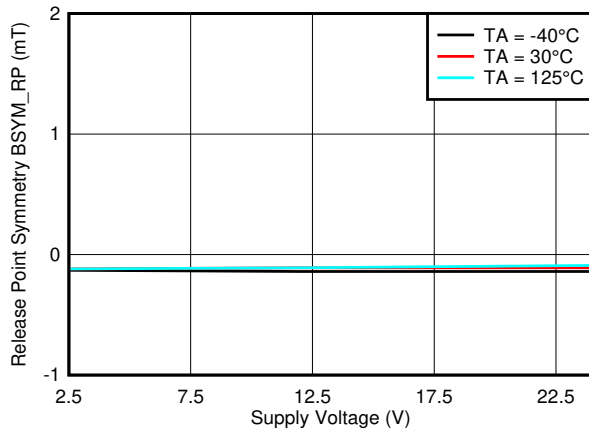

Figure 6-35. $B_{SYM_RP(XY)}$ vs V_{CC}

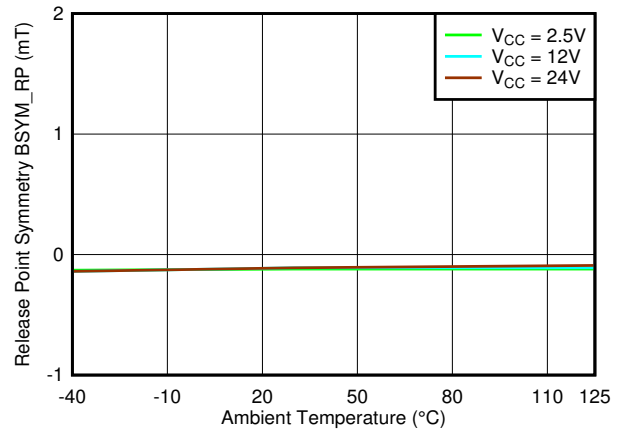
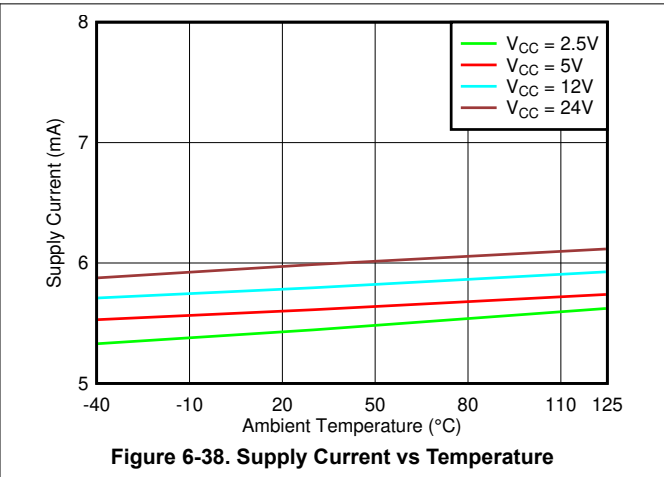
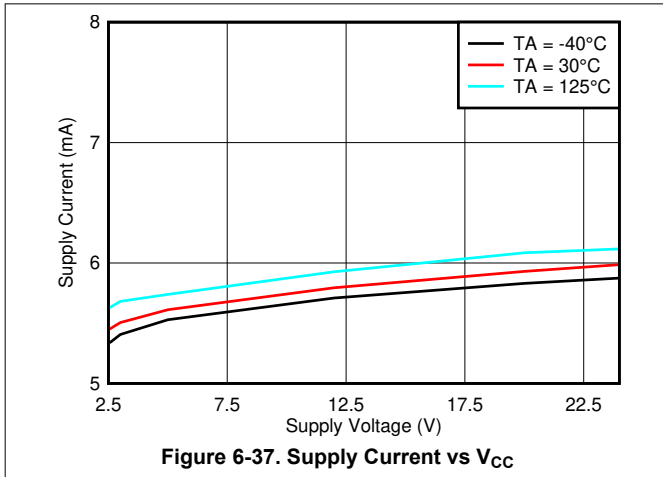

Figure 6-36. $B_{SYM_RP(XY)}$ vs Temperature

6.7 Typical Characteristics (continued)



6.7 Typical Characteristics (continued)

TMAG511xx4-Q1 versions

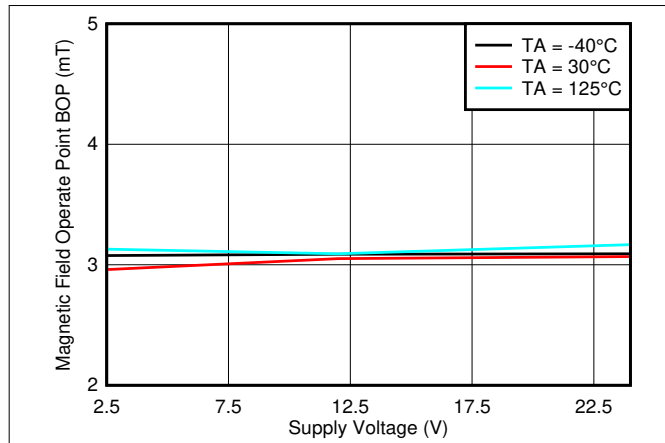

Figure 6-39. B_{OP_Z} Threshold vs V_{CC}

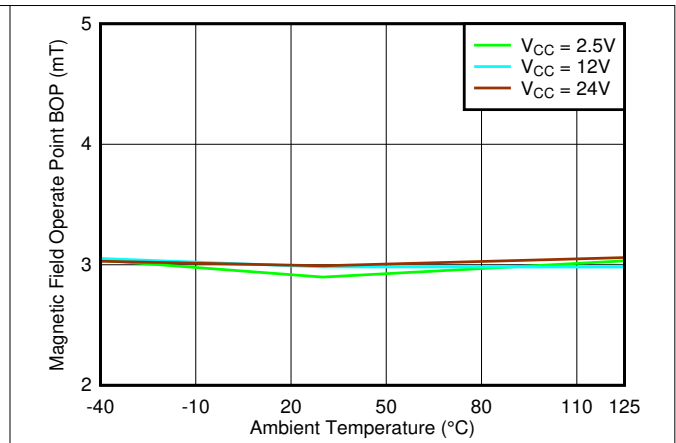

Figure 6-40. B_{OP_Z} Threshold vs Temperature

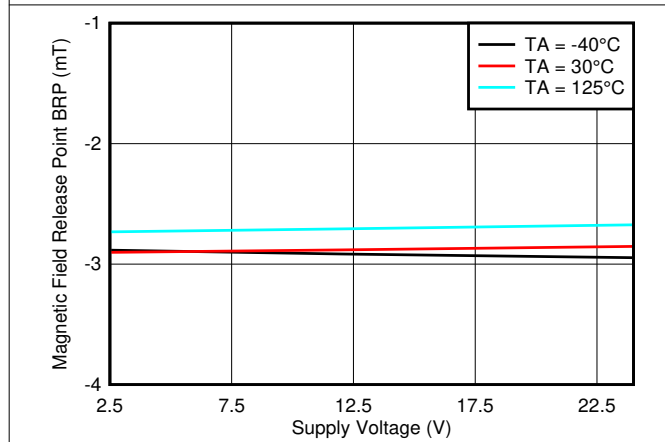

Figure 6-41. B_{RP_Z} Threshold vs V_{CC}

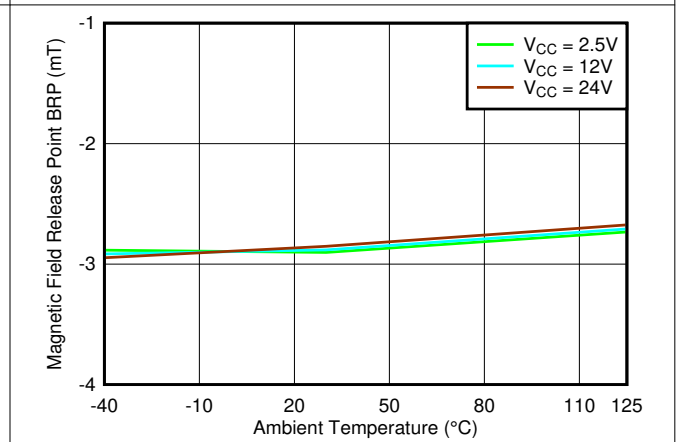

Figure 6-42. B_{RP_Z} Threshold vs Temperature

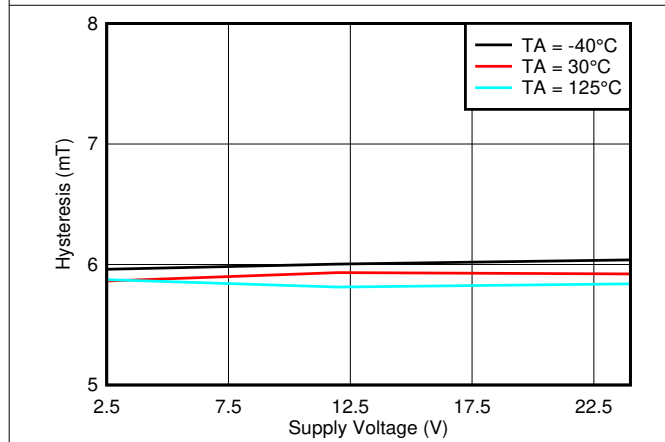

Figure 6-43. Hysteresis_Z vs V_{CC}

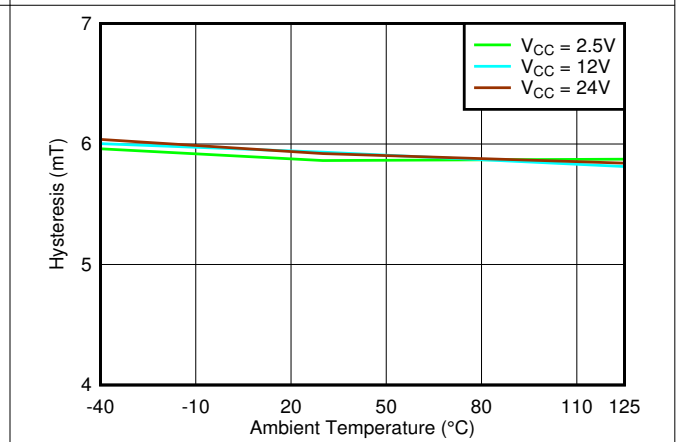

Figure 6-44. Hysteresis_Z vs Temperature

6.7 Typical Characteristics (continued)

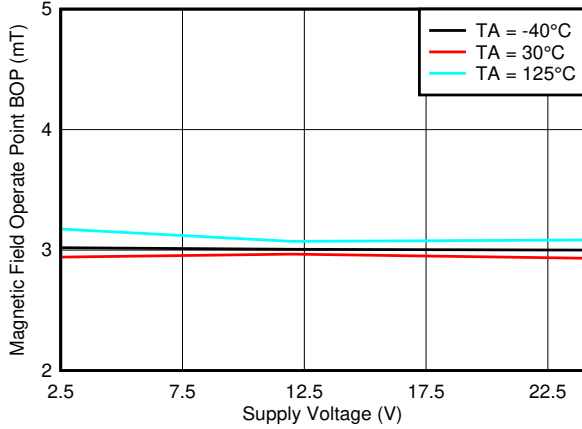

Figure 6-45. B_{OP_X} Threshold vs V_{CC}

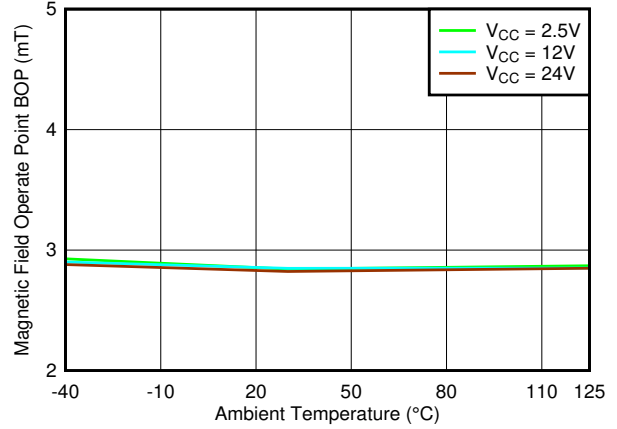

Figure 6-46. B_{OP_X} Threshold vs Temperature

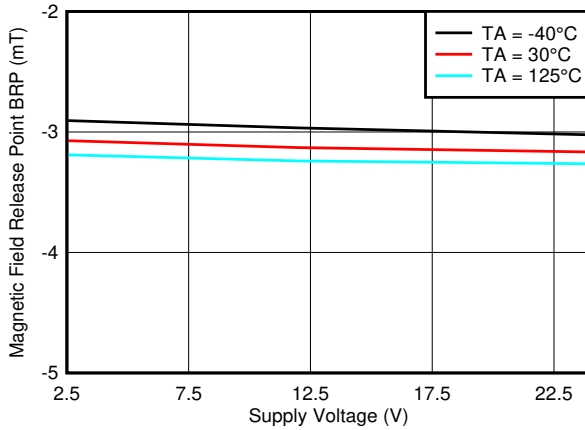

Figure 6-47. B_{RP_X} Threshold vs V_{CC}

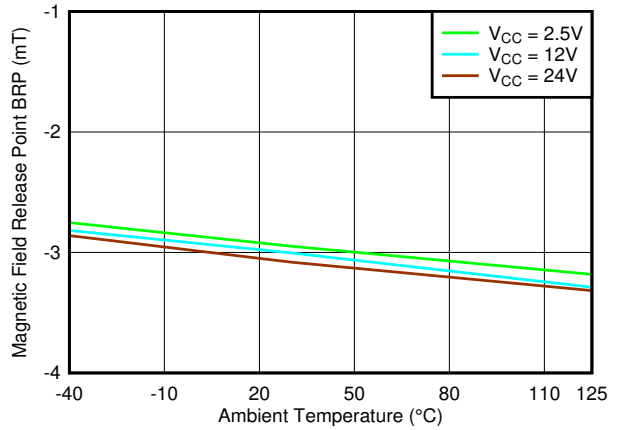

Figure 6-48. B_{RP_X} Threshold vs Temperature

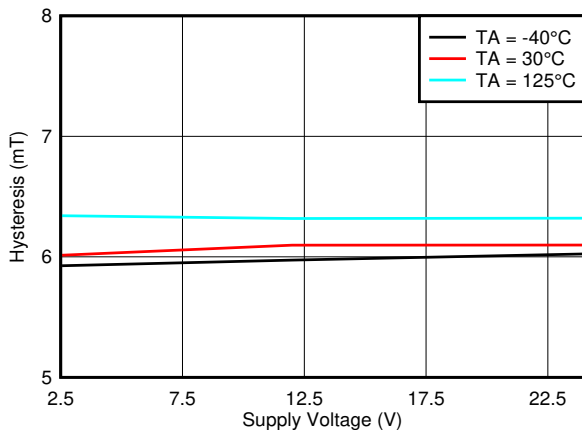

Figure 6-49. Hysteresis_X vs V_{CC}

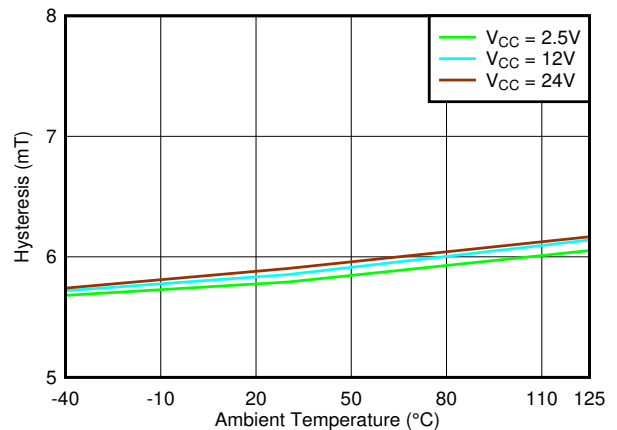

Figure 6-50. Hysteresis_X vs Temperature

6.7 Typical Characteristics (continued)

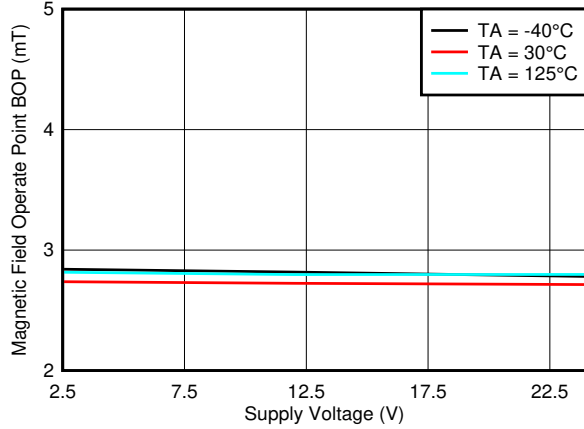

Figure 6-51. B_{OP_Y} Threshold vs V_{CC}

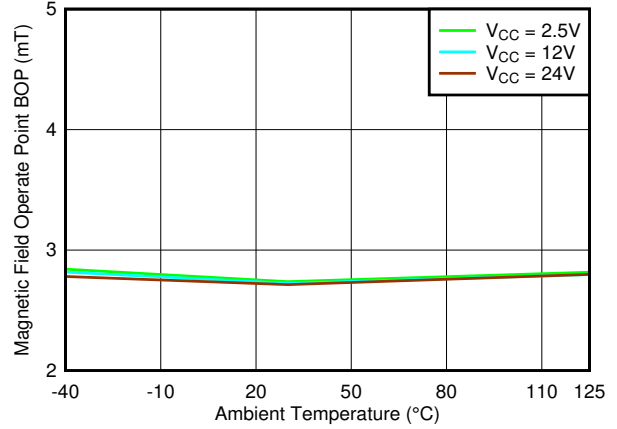

Figure 6-52. B_{OP_Y} Threshold vs Temperature

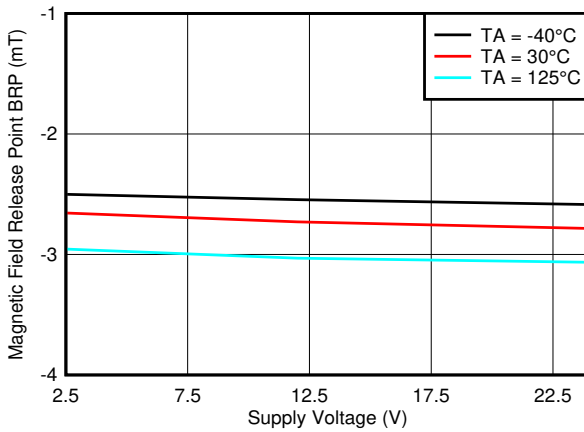

Figure 6-53. B_{RP_Y} Threshold vs V_{CC}

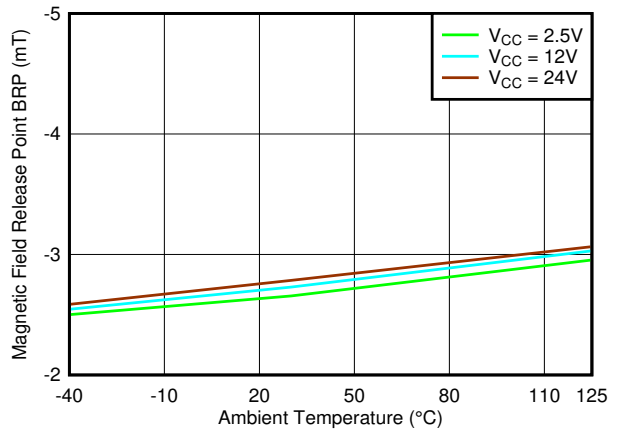

Figure 6-54. B_{RP_Y} Threshold vs Temperature

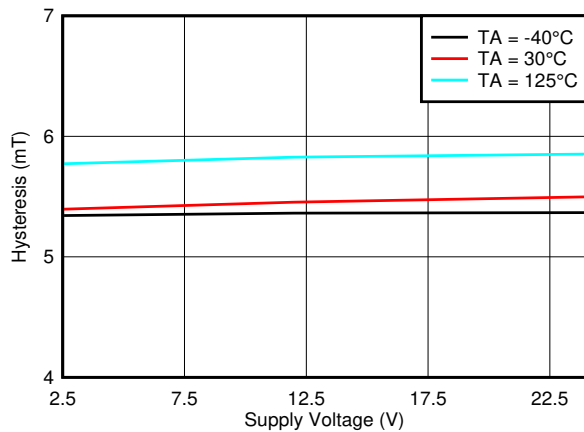

Figure 6-55. Hysteresis_Y vs V_{CC}

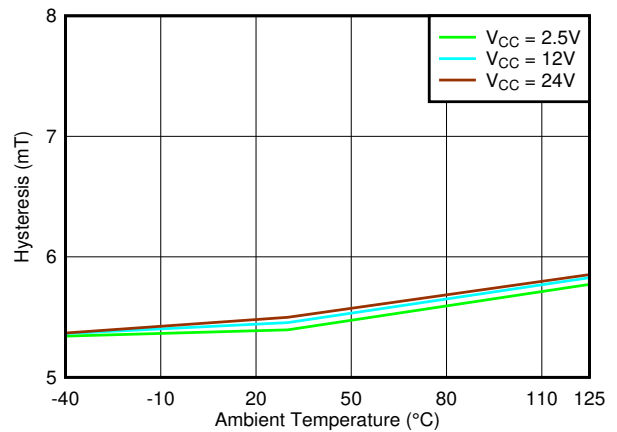
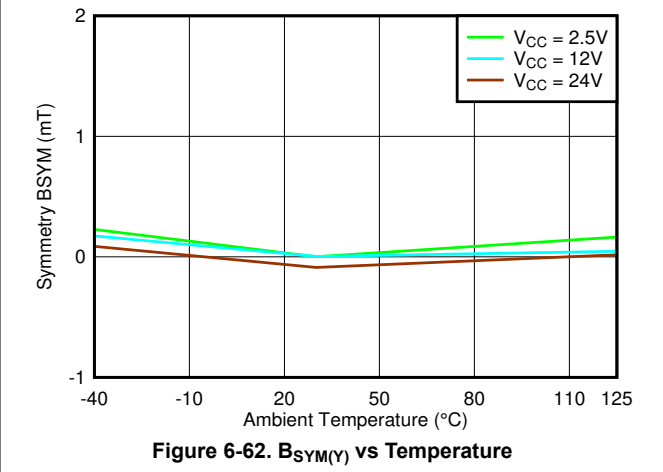
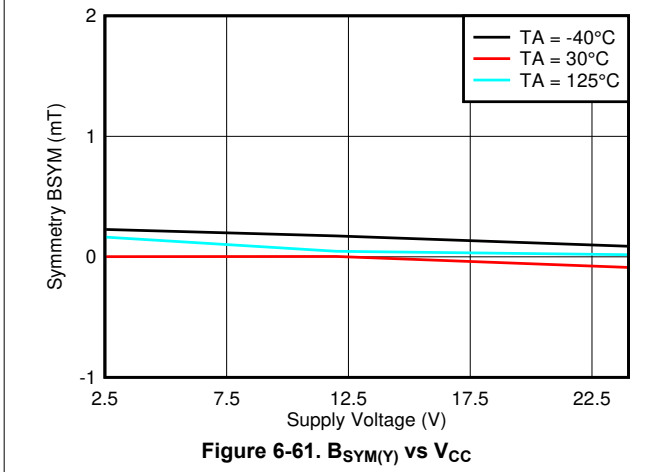
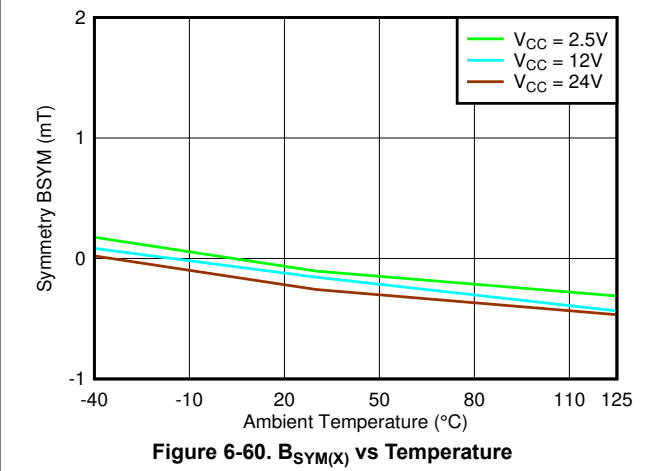
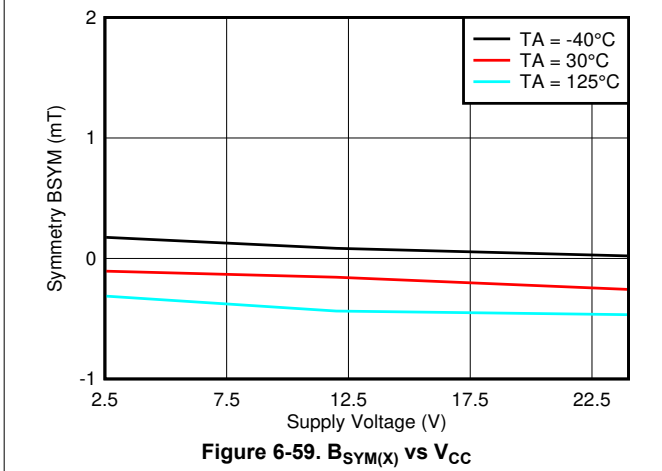
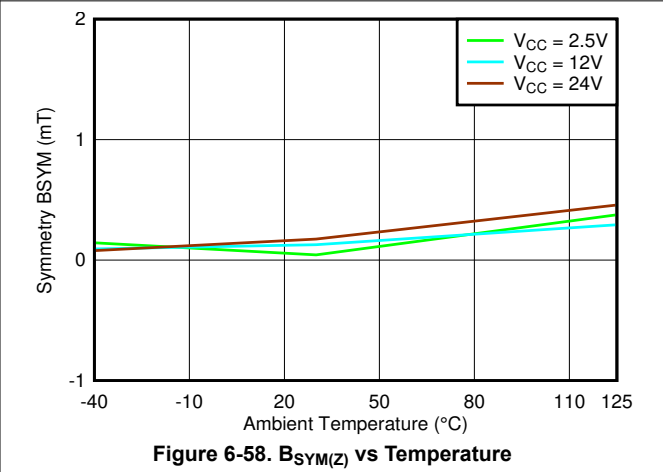
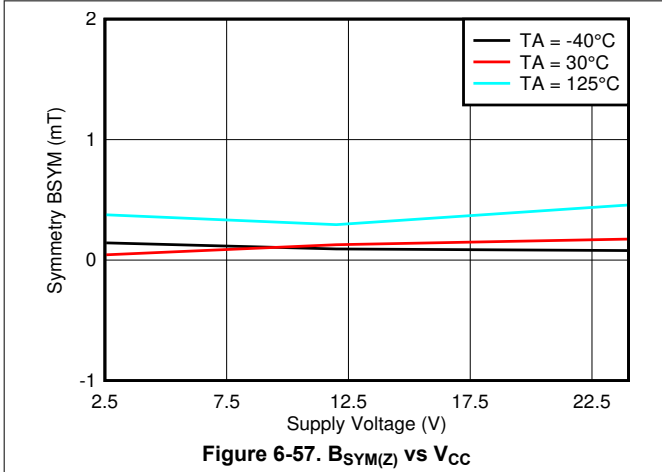

Figure 6-56. Hysteresis_Y vs Temperature

6.7 Typical Characteristics (continued)



6.7 Typical Characteristics (continued)

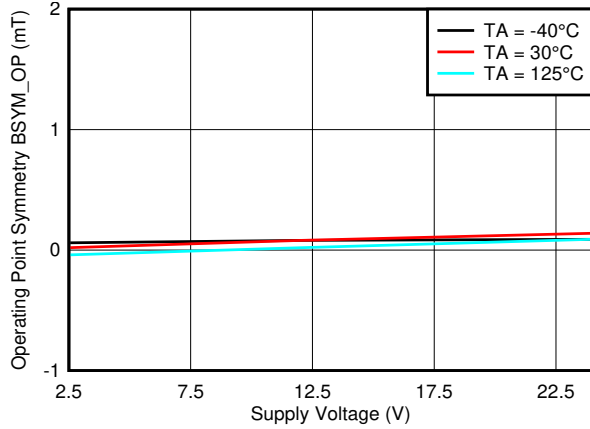

Figure 6-63. $B_{SYM_OP}(ZX)$ vs V_{CC}

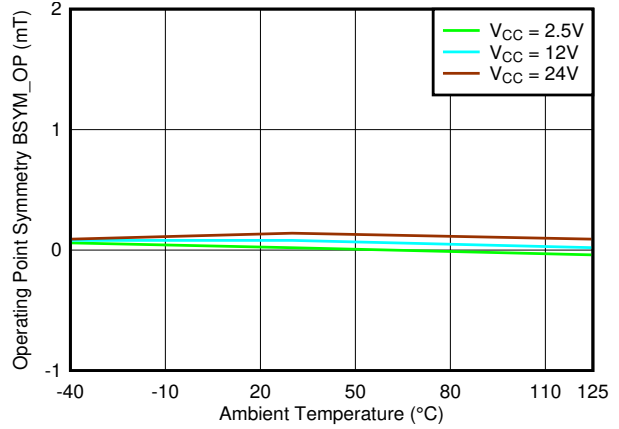

Figure 6-64. $B_{SYM_OP}(ZX)$ vs Temperature

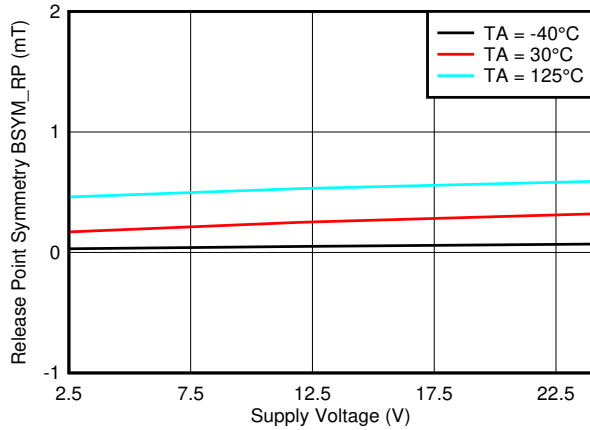

Figure 6-65. $B_{SYM_RP}(ZX)$ vs V_{CC}

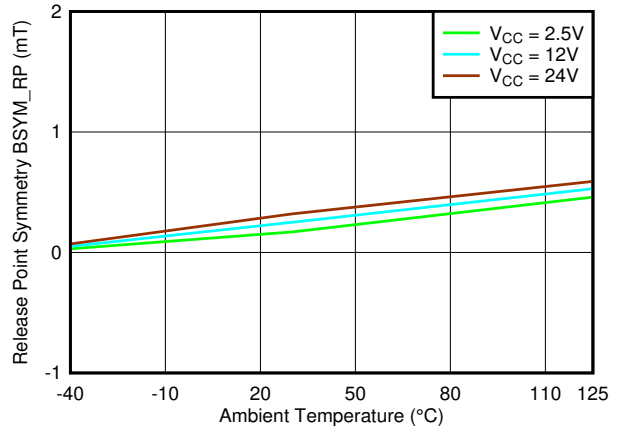

Figure 6-66. $B_{SYM_RP}(ZX)$ vs Temperature

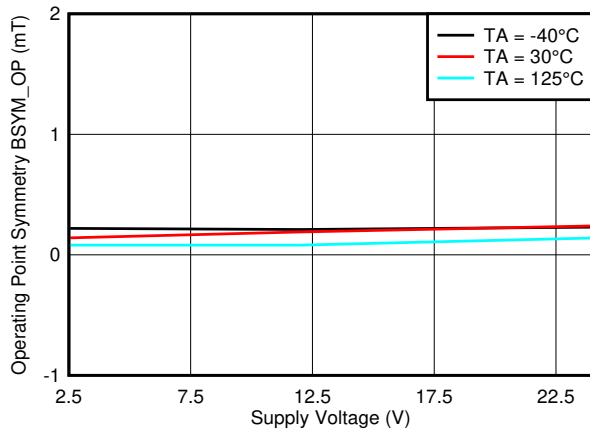

Figure 6-67. $B_{SYM_OP}(ZY)$ vs V_{CC}

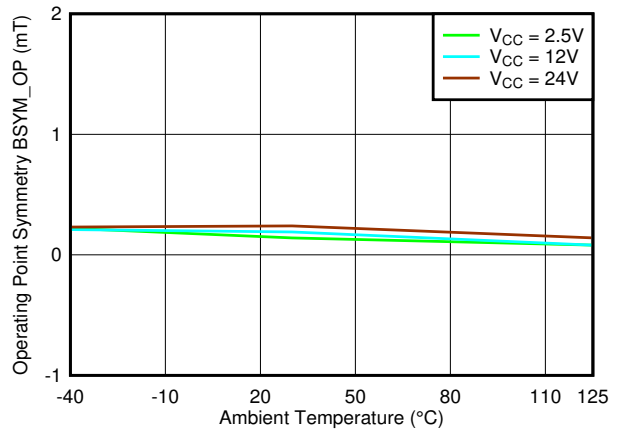

Figure 6-68. $B_{SYM_OP}(ZY)$ vs Temperature

6.7 Typical Characteristics (continued)

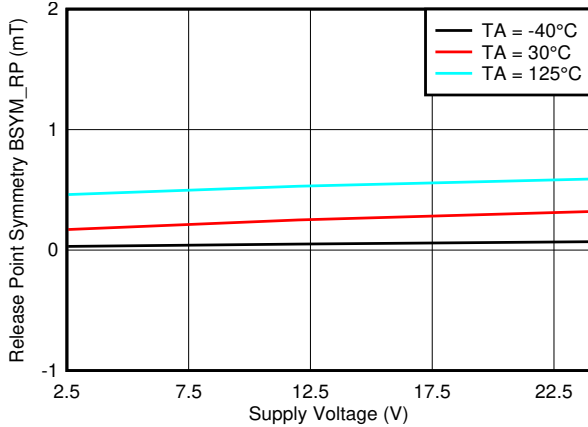

Figure 6-69. B_{SYM_RP(ZY)} vs V_{CC}

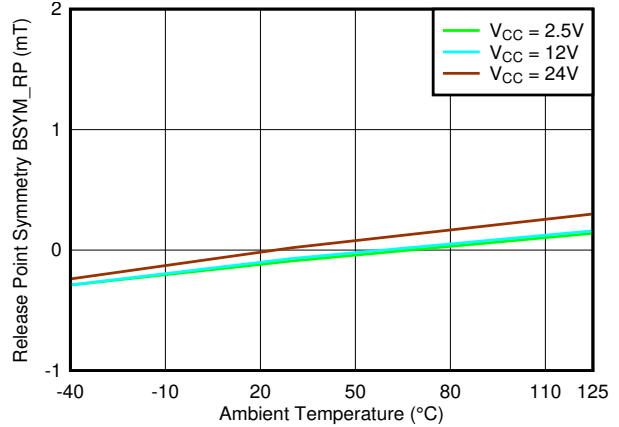

Figure 6-70. B_{SYM_RP(ZY)} vs Temperature

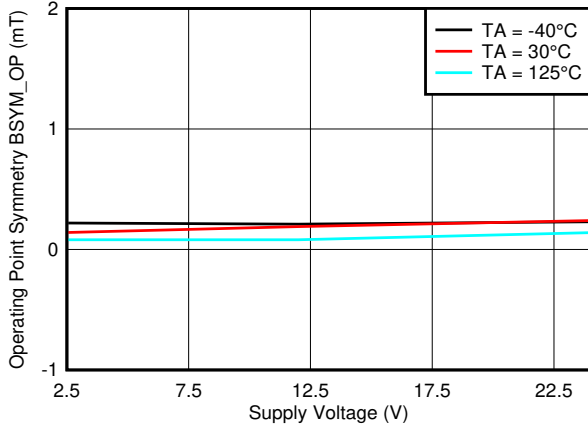

Figure 6-71. B_{SYM_OP(XY)} vs V_{CC}

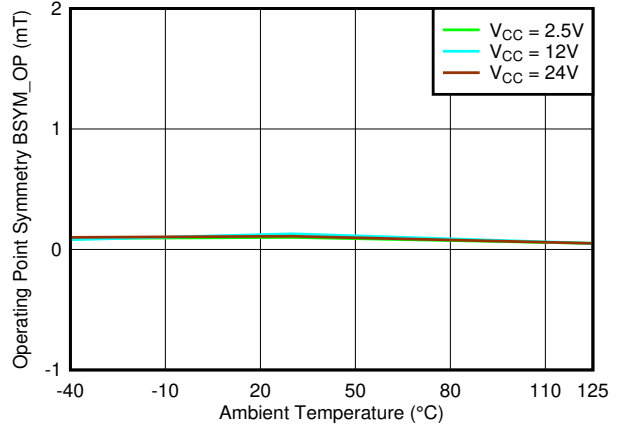

Figure 6-72. B_{SYM_OP(XY)} vs Temperature

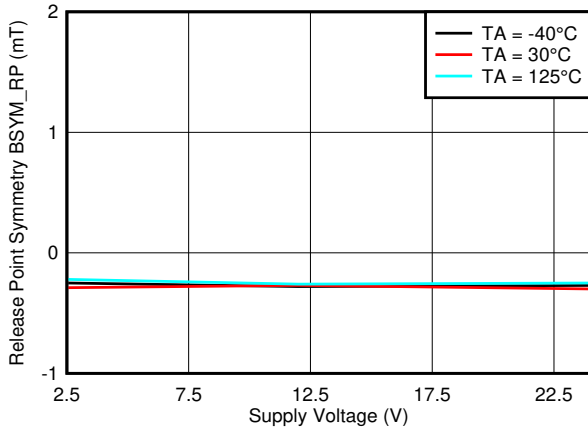

Figure 6-73. B_{SYM_RP(XY)} vs V_{CC}

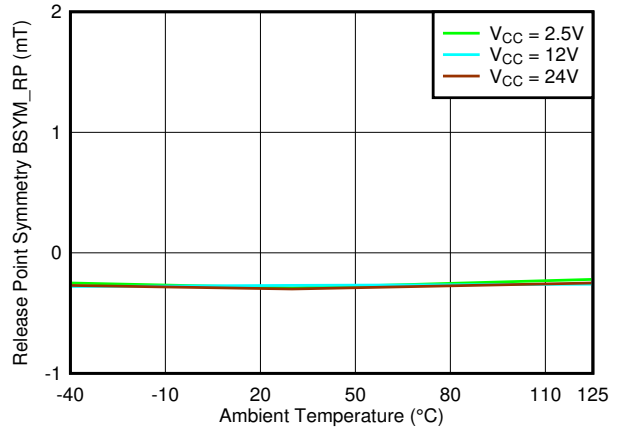

Figure 6-74. B_{SYM_RP(XY)} vs Temperature

6.7 Typical Characteristics (continued)

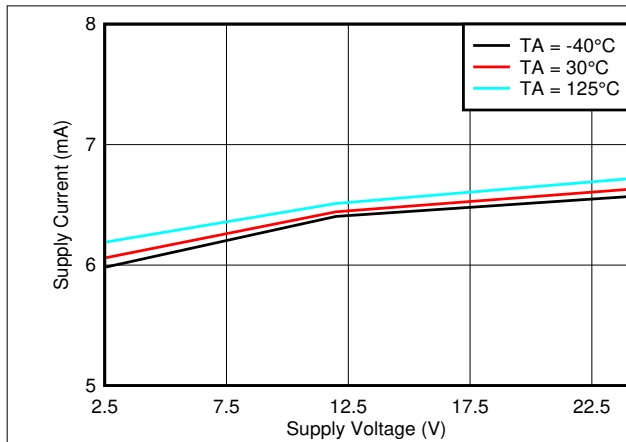

Figure 6-75. Supply Current vs V_{CC}

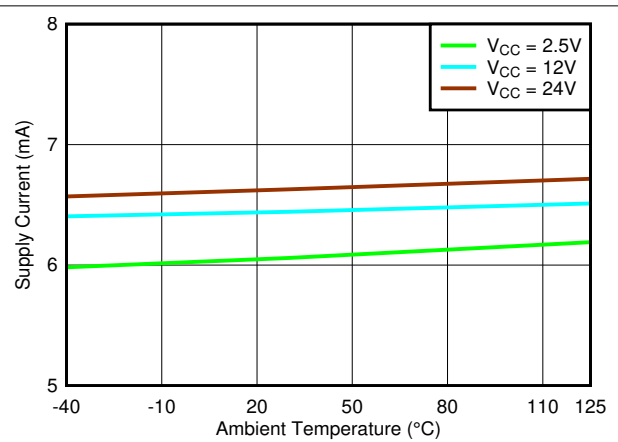

Figure 6-76. Supply Current vs Temperature

7 Detailed Description

7.1 Overview

The TMAG5110-Q1 and TMAG5111-Q1 are dual chopper-stabilized Hall effect sensors with two digital latched outputs for rotational magnetic sensing applications. The TMAG511x-Q1 device can be powered with a supply voltage between 2.5 V and 38 V, and survives continuous –20 V reverse-battery conditions. The TMAG511x-Q1 device only operates when a voltage of 2.5 V to 38 V applied to the V_{CC} pin (with respect to the GND pin). In addition, the device can withstand voltages up to 40 V for transient durations.

Alternating north and south magnetic poles are required to toggle the outputs of each Hall-effect latch.

The device is offered in a standard 3 mT typical operating point, as well as a high-sensitivity 1.4 mT typical operating point. The higher magnetic sensitivity provides flexibility in low-cost magnet selection and mechanical component placement. The TMAG511x-Q1 is also available in three 2-axis combination options (X-Y, Z-X, Z-Y) to support flexible multiple installation orientations relative to the magnet.

7.2 Functional Block Diagram

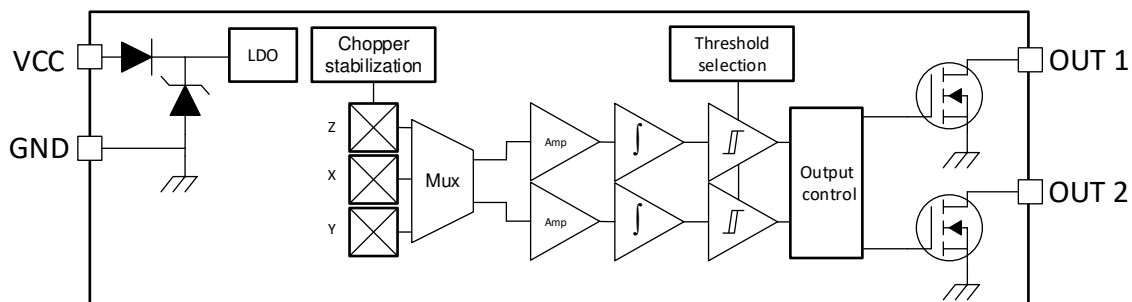

7.3 Feature Description

7.3.1 2D Description

7.3.1.1 2D General Description and Advantages

The best way to understand the advantage of a 2D dual latch hall sensor is to compare its behavior with others solutions used in the market. The two most common methods are: dual planar hall latch sensors or two single hall latch sensors. Those methods are used in applications such as rotary encoding or speed and direction sensing. The principle is to set two sensors apart at a certain angle such that they will sense the same magnetic field but with a fixed phase difference. The frequency of the signal will give the speed or incremental information while the phase will give the direction of rotation. For an easy read, the signals should be as close to a quadrature signal as possible, meaning there is a 90° phase shift between the two signals. To create those two signals in quadrature, the two latches must be placed at a distance of $\frac{1}{2}$ pole + n pole from one another.

The TMAG511x-Q1 can be used instead of a dual planar hall latch or two single hall latch sensors. The TMAG511x-Q1 has two integrated hall latch sensors spaced at a 90° angle from each other, which allows each sensor to detect a quadrature component of the same magnetic field. For A, B, and C device variants, the magnetic direction detected will be XY, ZX, and ZY, respectively. Each of those components are placed at 90° from each other by design, therefore the output signals will also be separated with the same angle value. Wherever the sensor is placed to catch the right two components of the field, the output will be in quadrature from one another. [Figure 7-1](#) shows the result of two different type of sensors when the devices are placed close to a ring magnet.

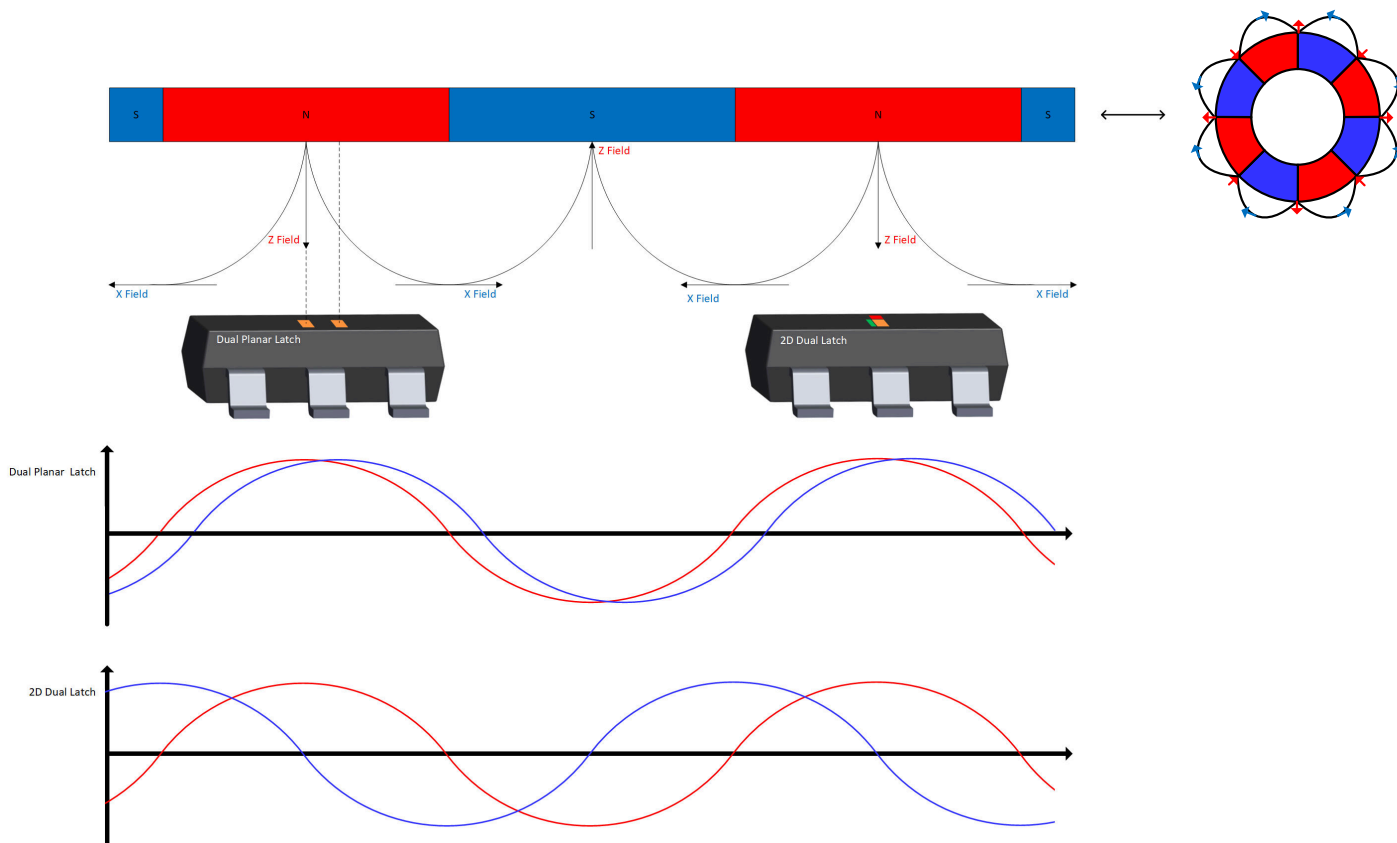

Figure 7-1. Dual Planar Latch vs. 2D Dual Latch

7.3.1.2 2D Magnetic Sensor Response

The TMAG5110-Q1 has two integrated latches that update their results to the OUT1 and OUT2 pins. Each one of these outputs will then have a latch functionality. Figure 7-2 shows the response to different magnetic poles for each output.

The TMAG5111-Q1 outputs are not directly connected to the two integrated latches. Additional processing is available to generate the speed and direction outputs.

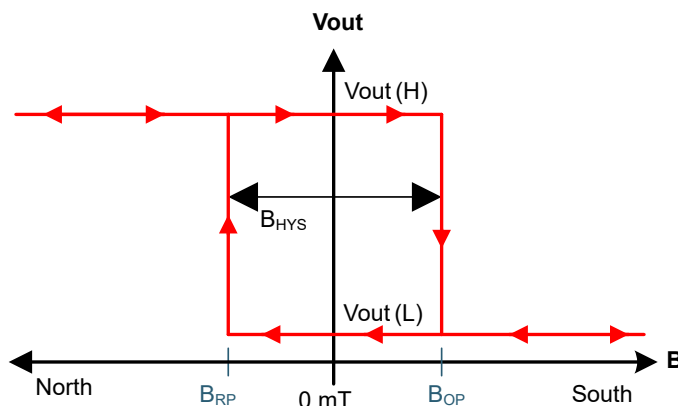

Figure 7-2. Latch Functionality

Figure 7-3 shows the magnetic response of both the TMAG5110-Q1 and TMAG5111-Q1 to a sinusoidal field. The sinusoidal curves represents the evaluation of the magnetic seen by both integrated hall sensors.

The TMAG5110-Q1 response shows both outputs reacting to this signal by going low once the field is higher than B_{OP} and going high when the field is lower than B_{RP} .

The TMAG5111-Q1 response shows how those two signals are processed to create a speed output and a direction output.

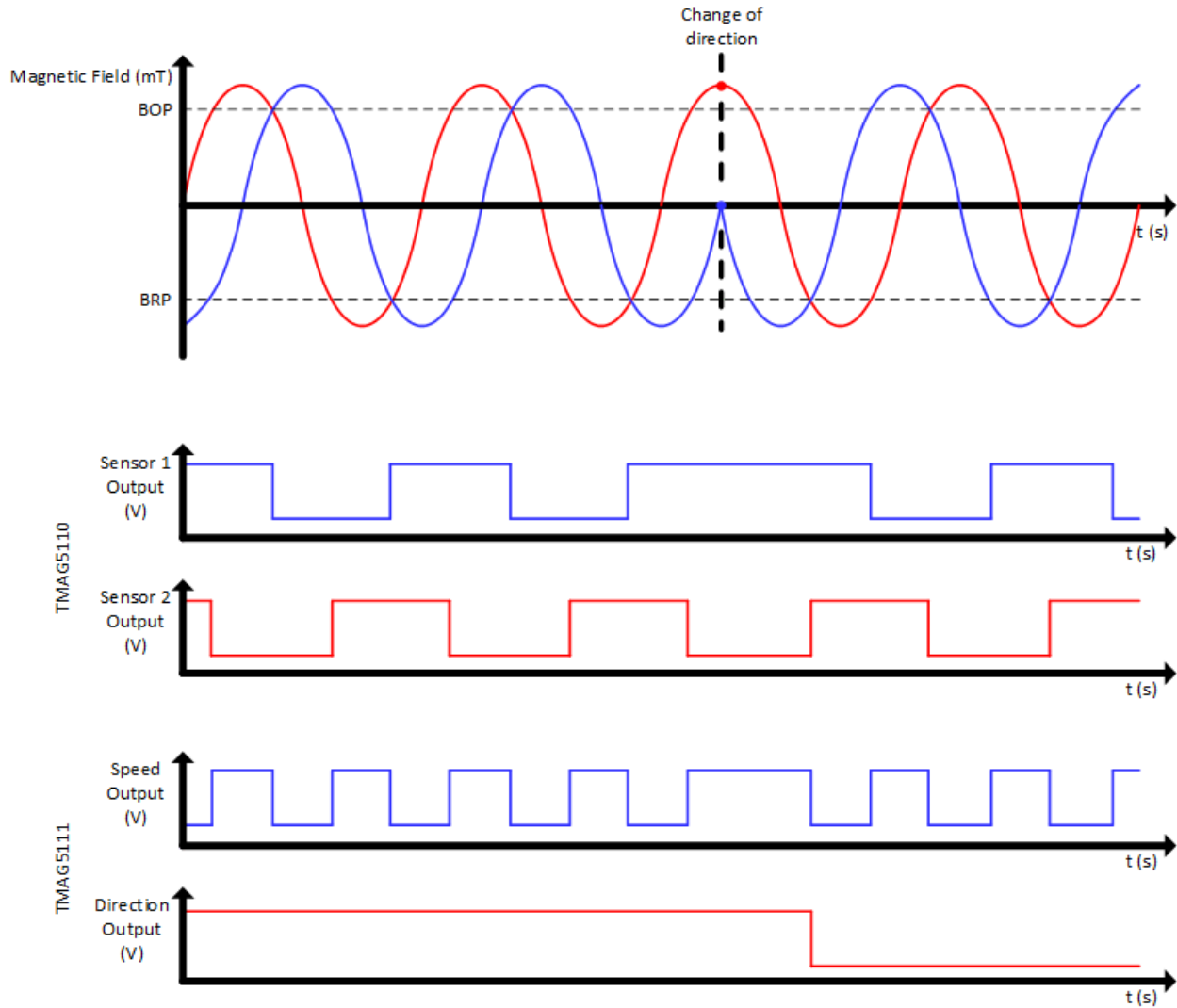

Figure 7-3. TMAG511x-Q1 Output Behavior

7.3.1.3 Axis Polarities

The Figure 7-4 shows the directions from where each axes are sensitive to a south pole. This also shows that the opposite directions are sensitive to the north pole.

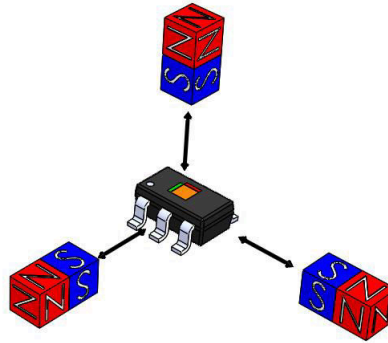

Figure 7-4. Axis Polarities

7.3.2 Axis Options

7.3.2.1 Device Placed In-Plane to Magnet

The outer edge of the magnet is the area where the magnetic field is the strongest. Placing the sensor on the outer edge of the magnet enables the sensor to get the best flexibility in terms of distance and sensitivity selection. The different figures below show how to use the different versions of the TMAG511x-Q1 in regards to the magnet and sensor placement.

The options shown in [Figure 7-5](#) and [Figure 7-6](#) composed of the X and Y axes enable the sensor to be placed in the same plane as the ring magnet. The sensor can be placed facing the magnet or on the side of the magnet. The part can also be turned at 180 degrees along the Z axis.

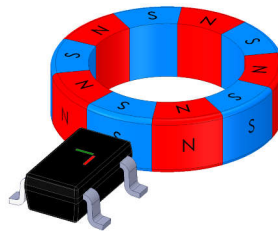

Figure 7-5. XY Outer Edge 1

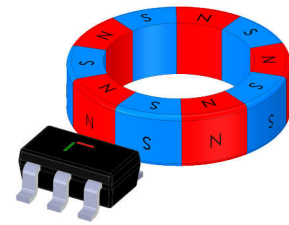

Figure 7-6. XY Outer Edge 2

The options shown in [Figure 7-7](#) and [Figure 7-8](#) composed of Z and X axes enable the sensor to be placed below the magnet, or facing the magnet with the front side of the device. The part can also be turned at 180 degrees along the Z axis.



Figure 7-7. ZX Outer Edge 1



Figure 7-8. ZX Outer Edge 2

The options shown in [Figure 7-9](#) and [Figure 7-10](#) composed of Z and Y axes also enable the sensor to be placed below the magnet in a different position, as well as facing the ring magnet with the side of the device. The part can also be turned at 180 degrees along the Z axis.



Figure 7-9. ZY Outer Edge 1



Figure 7-10. ZY Outer Edge 1

7.3.2.2 Device Placed on the Side Edge of the Magnet

The side edge of the magnet still provides a magnetic field, but the field is much weaker than the field on the outer edge. Placing the sensor on the side edge minimizes the flexibility as of how far the device can be placed from the ring magnet. The 2 mT version enables high sensitivity, allowing the application to work as well as when the device is placed on the outer edge. Nevertheless this option can be helpful in application where the sensor has to fit within the magnet diameter.

The options shown in [Figure 7-11](#) and [Figure 7-12](#) composed of X and Y axes enable the sensor to be placed facing the side edge of the magnet. The side of the sensor can also be placed next to the side edge of the magnet. The part can also be turned at 180 degrees along the Z axis.

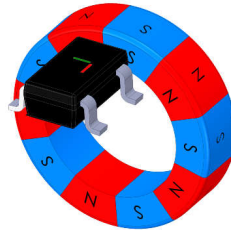

Figure 7-11. XY Side Edge 1

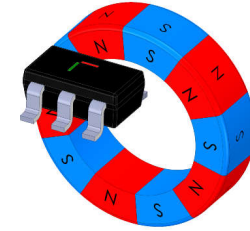

Figure 7-12. XY Side Edge 2

The options shown in [Figure 7-13](#) and [Figure 7-14](#) composed of Z and X axis enable another way to place the sensor facing the side edge of the magnet. The top of the sensor can also be placed facing the side edge of the magnet. The part can also be turned at 180 degrees along the Z axis.



Figure 7-13. ZX Side Edge 1

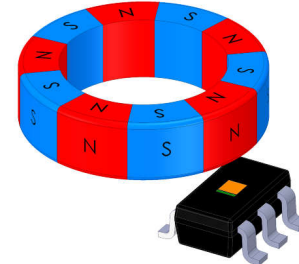

Figure 7-14. ZX Side Edge 2

The options shown in [Figure 7-15](#) and [Figure 7-16](#) composed of Z and Y axes enable the placement of the sensor on the side edge of a magnet with the pins facing the magnet, or with top of the sensor facing the side edge of the magnet. The part can also be turned at 180 degrees along the Z axis.

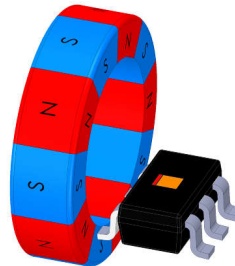

Figure 7-15. ZY Side Edge 1

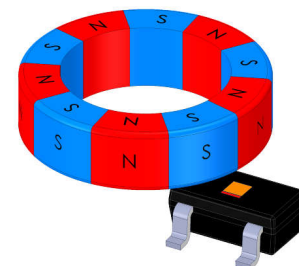

Figure 7-16. ZY Side Edge 1

7.3.3 Power-On Time

Figure 7-17 shows the behavior of the device after the V_{CC} voltage is applied and when the field is below the B_{OP} threshold. When the minimum value for V_{CC} is reached, the TMAG5110-Q1 takes time t_{ON} to power up and then time t_{PD} to update the output to a level High.

Figure 7-18 shows the behavior of the device after the V_{CC} voltage is applied and when the field is above the B_{OP} threshold. When the minimum value for V_{CC} is reached, the TMAG5110-Q1 takes time t_{ON} to power up and then time t_{PD} to update the output to a level High.

For the TMAG5111-Q1, the power-on behavior is similar, but OUT1 updates to Low during the t_{PD} time. OUT2 updates to High during the t_{PD} time. The output value following the power-on sequence then depends on the magnet placement, the sense of rotation, and the device variant.

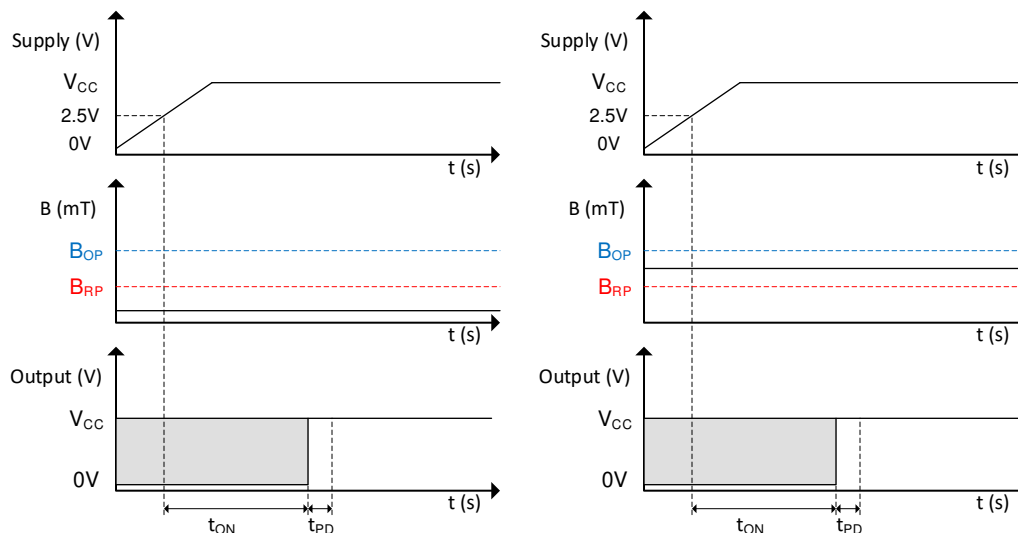

Figure 7-17. Power-On Time When $B < B_{OP}$

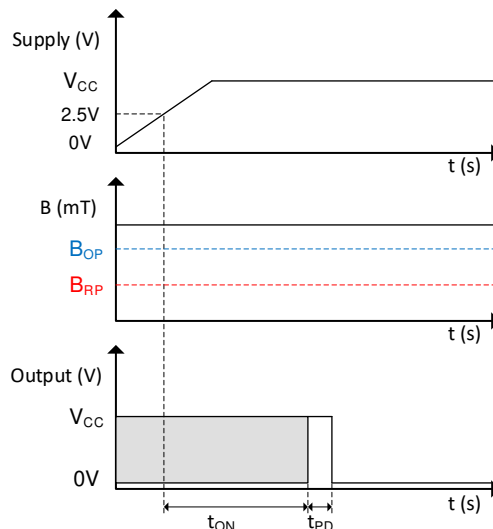

Figure 7-18. Power-On Time When $B > B_{OP}$

TMAG5110-Q1 devices with the R pinout version have a Low output state during the t_{PD} time. The output stays Low if the field sensed at power-on is between B_{OP} and B_{RP} , until B_{RP} is crossed. This behavior for the TMAG5110-Q1 R pinout versions can be seen in Figure 7-19 and Figure 7-20.

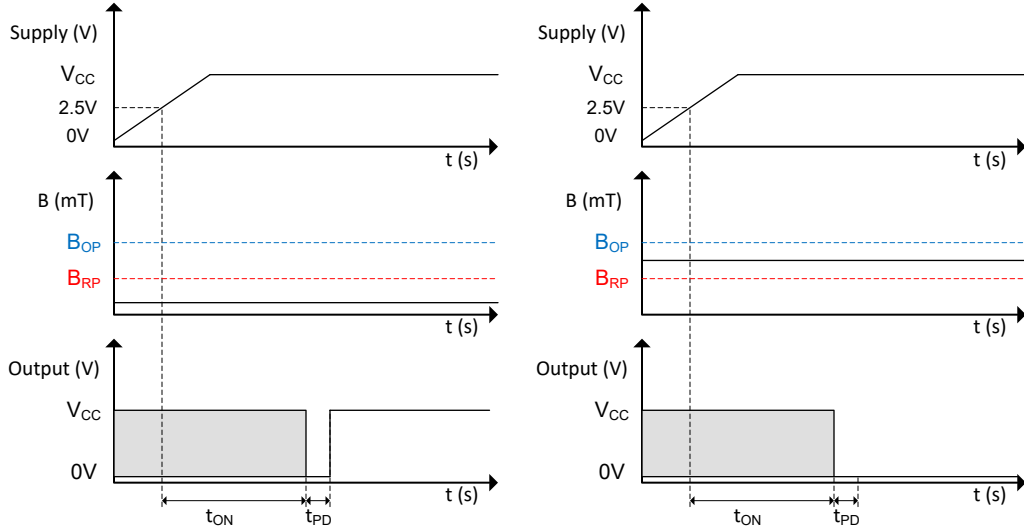

Figure 7-19. Power-On Time When $B < B_{OP}$ (R Pinout Version)

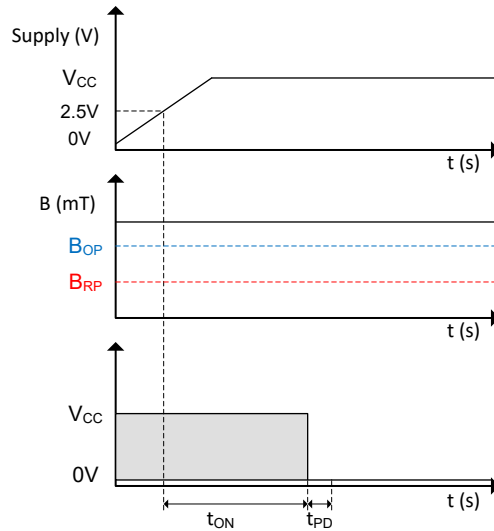

Figure 7-20. Power-On Time When $B > B_{OP}$ (R Pinout Version)

7.3.4 Propagation Delay

The TMAG511x-Q1 samples the Hall element at a nominal sampling interval of t_{PD} to detect the presence of a magnetic south pole. Between each sampling interval, the device calculates the average magnetic field applied to the device. As defined in Figure 7-22, if this average value crosses the B_{OP} or B_{RP} threshold, the device changes the corresponding level. Because the system, Hall sensor + magnet is by nature asynchronous, the propagation delay t_d will vary depending on when the magnetic field goes above the B_{OP} value. As shown in Figure 7-21 the output delay will then depend on when the magnetic field will get higher than the B_{OP} value. The first graph shows the typical case.

The magnetic field goes above the B_{OP} value at the moment where the output is updated. The part will then only need one cycle of t_{PD} to update the output. The second graph shows a magnetic field going above the B_{OP} value just right before half of the sampling period. This is the best case possible where the output will be updated in just half of the sampling period. Finally, the third graph shows the worst possible case where the magnetic field goes above the BOP value just after half of the sampling period. At the next output update, the value will still see a value under the threshold and will need a whole new period to update the output

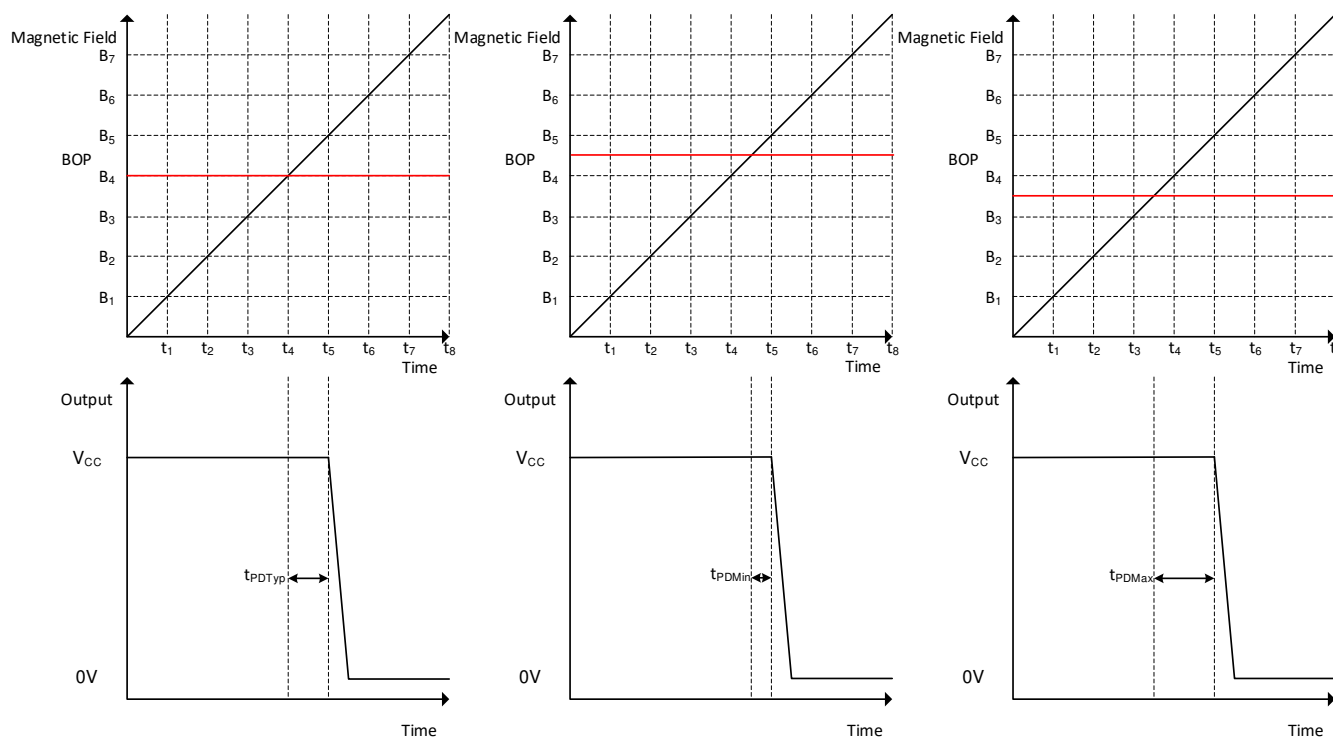

Figure 7-21. Field Sampling Timing

Figure 7-22 shows TMAG511x-Q1 propagation delay analysis when a magnetic south pole is applied. The Hall element of the TMAG511x-Q1 experiences an increasing magnetic field as a magnetic south pole approaches near the device as well as a decreasing magnetic field as a magnetic south pole leaves away. At time t_1 the magnetic field goes above the B_{OP} threshold. The output will then start to move after the time t_{PD} . As shown in Figure 7-22, this time will vary depending on when the sampling period is. At t_2 the output start pulling to the low voltage value. At t_3 the output is completely pulled down to the lower voltage value. The same process happen on the other way when the magnetic value is going under the B_{OP} threshold.

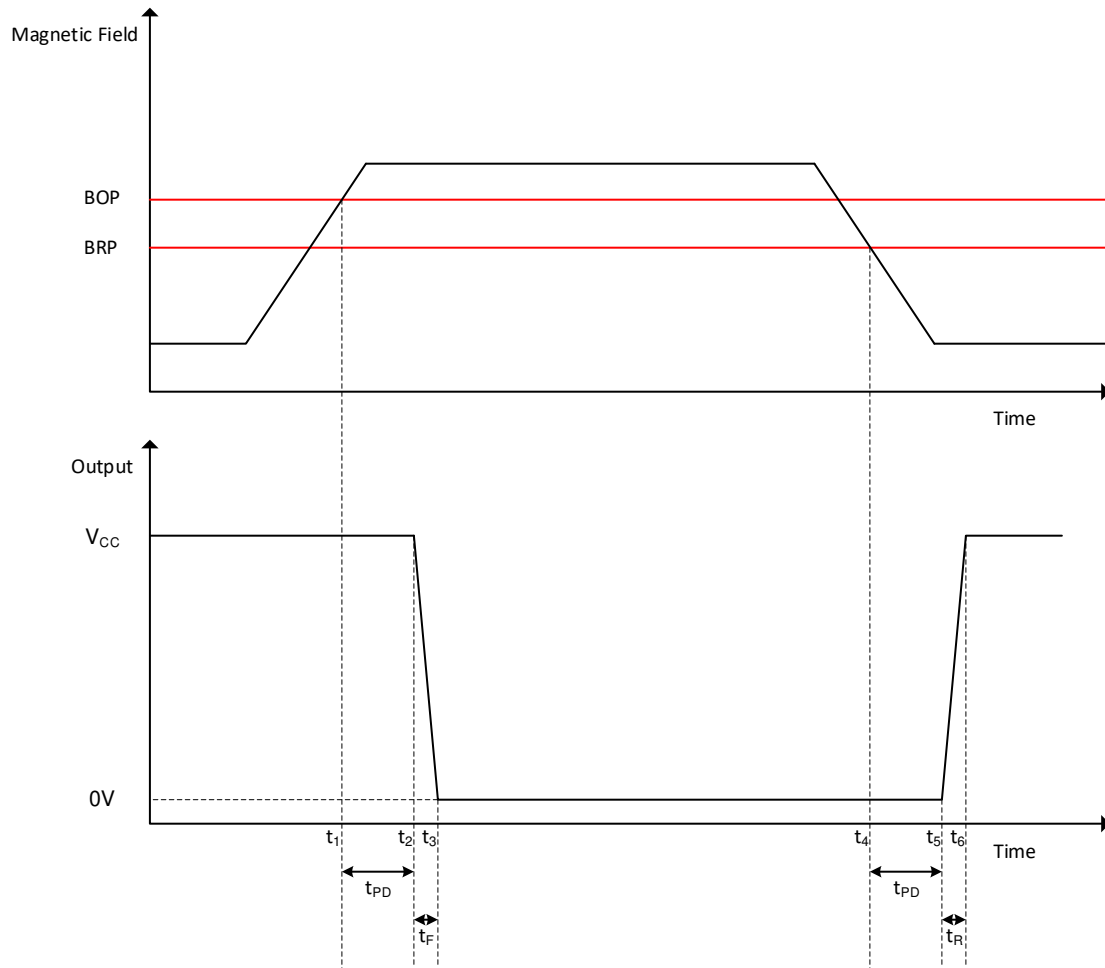

Figure 7-22. Propagation Delay

7.3.5 Hall Element Location

The sensing element inside the device is in the center when viewed from the top. Figure 7-23 shows the exact position of the sensors in regard of the package.

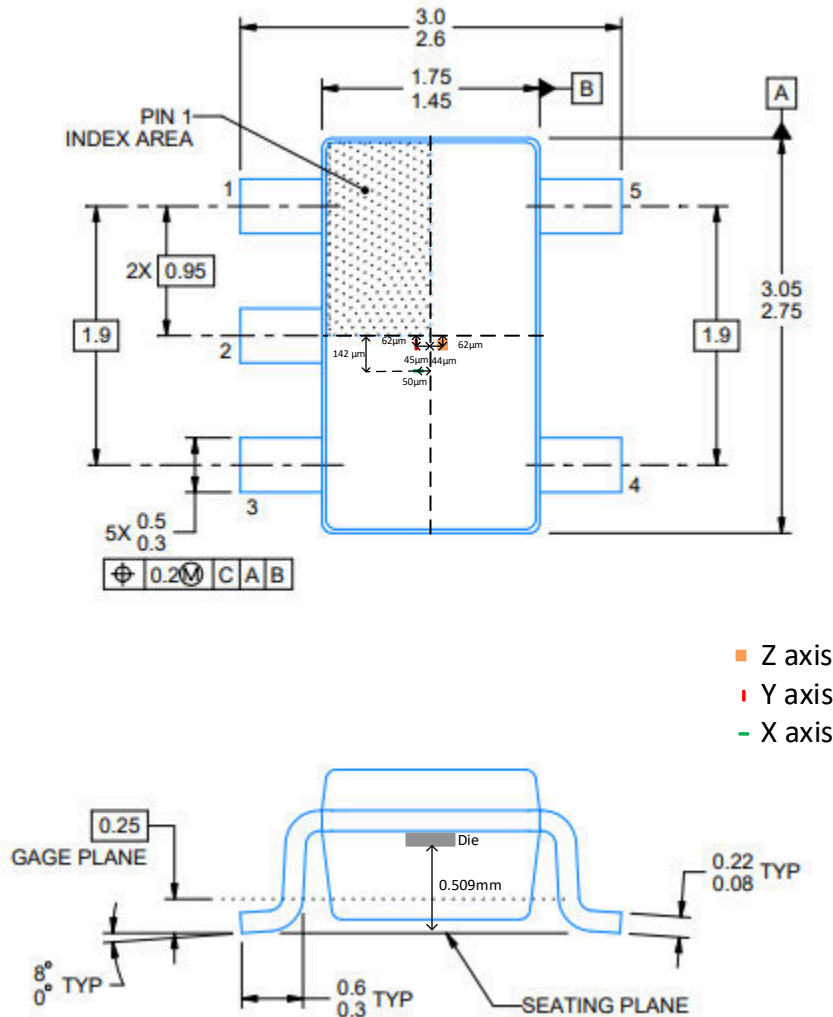

Figure 7-23. Hall Element Location

7.3.6 Power Derating

The device is specified from -40°C to 125°C for a voltage rating of 2.5 V to 38 V. Because the part is draining at its maximum a current of 17 mA the maximum voltage that can be applied will depend on what is the maximum ambient temperature acceptable for the application. The curve in Figure 7-24 shows the maximum acceptable power supply voltage versus the maximum acceptable ambient temperature.

The [Figure 7-24](#) can also be calculated using the following formulas:

$$T_J = T_A + \Delta T \tag{1}$$

where

- T_J is the junction temperature
- T_A is the ambient temperature
- ΔT is the difference between the junction temperature and the ambient temperature

$$\Delta T = P_D \times R_{\theta JA} \tag{2}$$

where

- P_D is the power dissipated by the part
- $R_{\theta JA}$ is the junction to ambient thermal resistance

$$P_D = V_{CC} \times I_{CC} \tag{3}$$

where

- V_{CC} is the voltage supply of the device
- I_{CC} is the current consumption of the device

Combining the three equations above gives [Equation 4](#) below:

$$V_{CC \max} = \frac{T_{J \max} - T_A}{I_{CC \max} \times R_{\theta JA}} \tag{4}$$

This equation gives the maximum voltage the part can handle in regards of the ambient temperature.

For example, with an the application required to work within a ambient temperature of maximum 85°C, and $T_{J \max}$, $R_{\theta JA}$ and $I_{CC \max}$ are defined in the data sheet, the maximum voltage allowed for this application is determined in [Equation](#):

$$V_{CC \max} = \frac{170^\circ\text{C} - 140^\circ\text{C}}{6.5 \text{ mA} \times 166.5^\circ\text{C} / \text{W}} = 27.72 \text{ V}$$

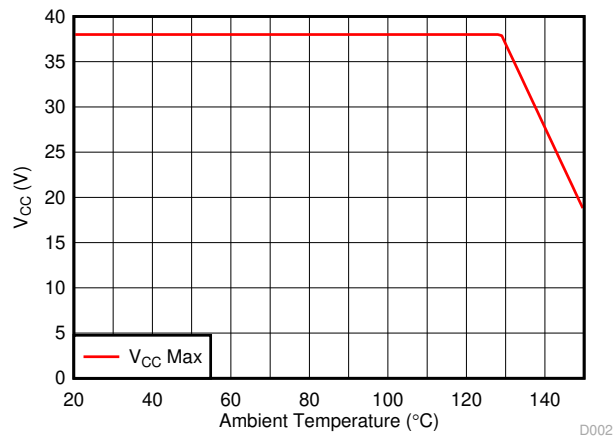

Figure 7-24. Power Derating Curve

7.4 Device Functional Modes

The TMAG511x-Q1 device has one mode of operation that applies when the *Recommended Operating Conditions* are met.

8 Application and Implementation

Note

Information in the following applications sections is not part of the TI component specification, and TI does not warrant its accuracy or completeness. TI's customers are responsible for determining suitability of components for their purposes, as well as validating and testing their design implementation to confirm system functionality.

8.1 Application Information

The TMAG511x-Q1 is designed for rotary applications for DC motor sensors or incremental rotary encoding.

For reliable functionality, the magnet must apply a flux density at the sensor greater than the corresponding maximum B_{OP} or B_{RP} numbers specified in the [Magnetic Characteristics](#) table. Add additional margin to account for mechanical tolerance, temperature effects, and magnet variation. Magnets generally produce weaker fields as temperature increases.

8.2 Typical Applications

8.2.1 Incremental Rotary Encoding Application

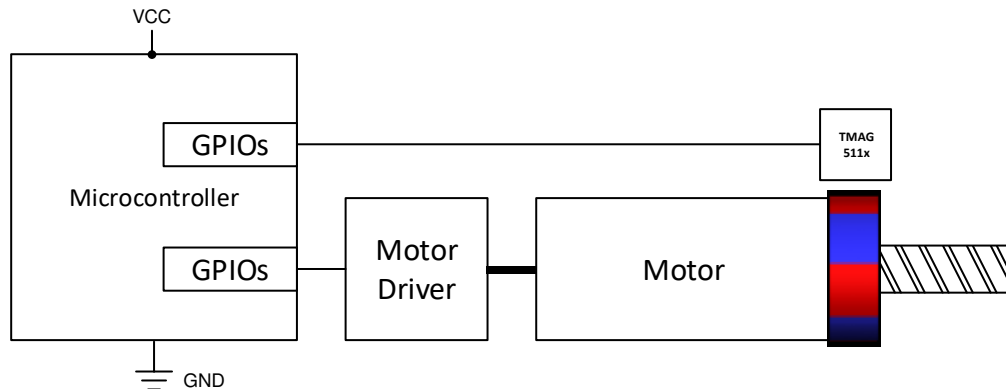

Figure 8-1. Incremental Encoding

8.2.1.1 Design Requirements

[Table 8-1](#) lists the use the parameters for this design.

Table 8-1. Design Parameters

DESIGN PARAMETER	EXAMPLE VALUE
Motor speed	22.5 kRPM
Number of magnet poles	8
Dimensions	9.7 mm diameter × 2 mm thick
Magnetic material	Ceramic 8D
Air gap above the Hall sensors	2.5 mm
Radial magnetic flux density peak	±12.5 mT
Tangential magnetic flux density peak	±9.5 mT

8.2.1.2 Detailed Design Procedure

Incremental encoders are used on knobs, wheels, motors, and flow meters to measure relative rotary movement. By attaching a ring magnet to the rotating component and placing the TMAG511x-Q1 nearby, the sensor will generate voltage pulses as the magnet turns. The TMAG511x-Q1 integrates two sensors and two signal chains. This means each channel can go up to the maximum speed independently from each other.

When the magnet rotates, the TMAG5110-Q1 will generate alternate pulses on each output. One input will be the result of what is sensed from one specific axis, while the other output will sense from another specific axis. In [Table 8-1](#), this is also referred as Radial and Tangential magnetic flux. Those two signals are the result of two different components of the same magnetic field resulting in the two signals being 90° from one another. Also called quadrature output, this type of signal is ideal to measure a rotational count as well as a change in direction of the ring magnet.

The TMAG5111-Q1 directly generates the speed and direction outputs. This eliminates the need for external processing.

The maximum rotational speed that can be measured is limited by the sensor bandwidth and the magnetic strength of the magnet.

Generally, the bandwidth must be faster than two times the number of poles per second. In this design example, the maximum speed is 22500 RPM, which involves a rotation of 3000 poles per second when using an 8-pole magnet. The TMAG511x-Q1 sensing bandwidth is typically 40 kHz, which is more than thirteen times the pole frequency.

The strength of the magnet also has an impact on how fast the magnet can turn. A weaker magnet with a maximum strength very close to the threshold value will limit the maximum speed by limiting the amount of time where this field will be higher than the B_{OP} . The time spent above the B_{OP} value will be longer for a magnet with stronger field.

When the magnet strength is significantly higher than B_{OP} , [Equation 5](#) can be used to calculate the allowed speed.

$$\text{Speed (RPM)} \leq \frac{\text{Bandwidth (Hz)} \times 60}{\text{Number of poles}} \tag{5}$$

8.2.1.3 Application Curve

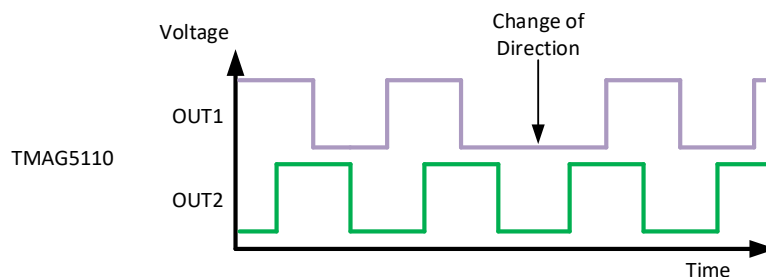

Figure 8-2. TMAG5110-Q1 Output Response

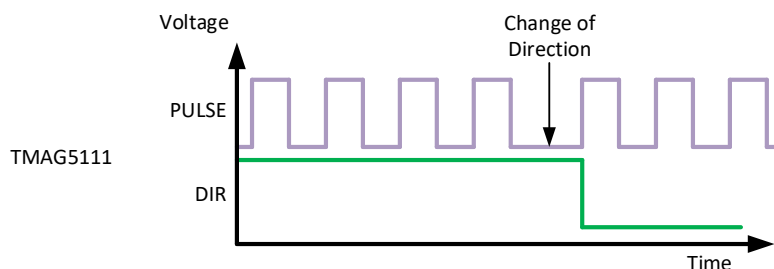

Figure 8-3. TMAG5111-Q1 Output Response

8.3 Power Supply Recommendations

The TMAG511x-Q1 is powered by 2.5-V to 38-V DC power supplies. A decoupling capacitor placed close to the device must be used to provide local energy with minimal inductance. TI recommends using a ceramic capacitor with a value of at least 0.01 μF .

8.4 Layout

8.4.1 Layout Guidelines

Magnetic fields pass through most non-ferromagnetic materials with no significant disturbance. Embedding Hall effect sensors within plastic or aluminum enclosures and sensing magnets on the outside is common practice. Magnetic fields also easily pass through most printed-circuit boards (PCBs), which makes placing the magnet on the opposite side of the PCB possible.

8.4.2 Layout Example

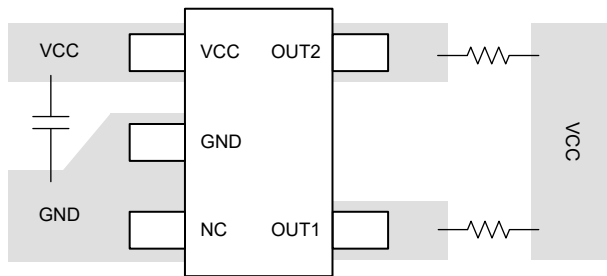

Figure 8-4. Layout Example (Pinout Version: A)

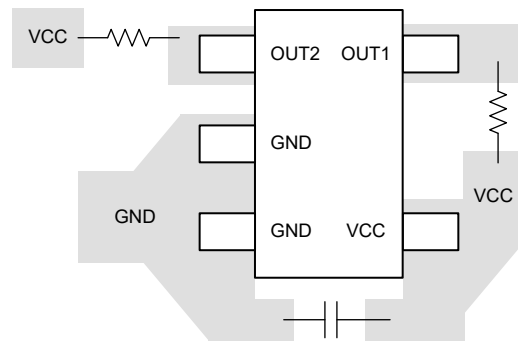

Figure 8-5. Layout Example (Pinout Version: R)

9 Device and Documentation Support

9.1 Device Support

9.1.1 Device Nomenclature

Figure 9-1 shows a legend for reading the complete orderable part numbers.

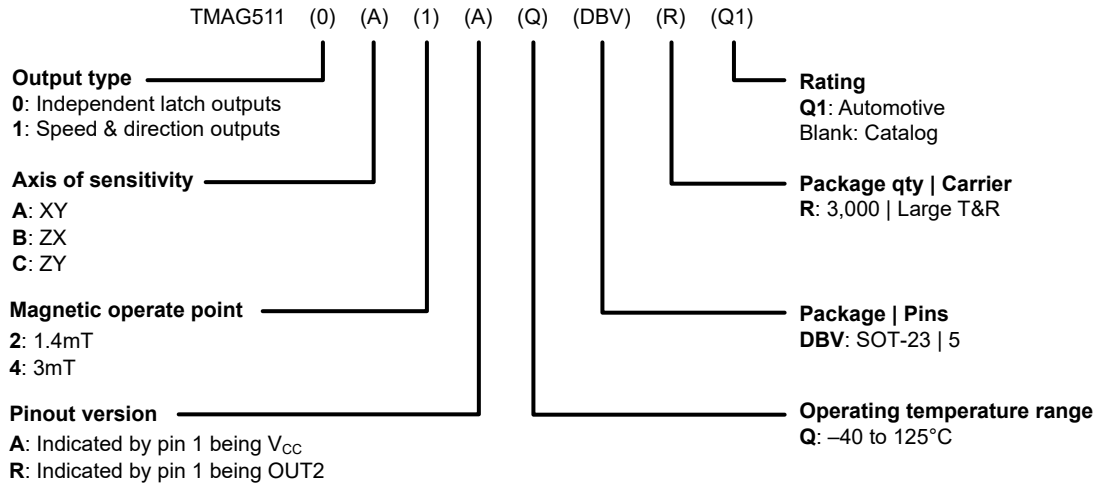

Figure 9-1. Device Nomenclature

9.2 Receiving Notification of Documentation Updates

To receive notification of documentation updates, navigate to the device product folder on ti.com. Click on *Notifications* to register and receive a weekly digest of any product information that has changed. For change details, review the revision history included in any revised document.

9.3 Support Resources

[TI E2E™ support forums](#) are an engineer's go-to source for fast, verified answers and design help — straight from the experts. Search existing answers or ask your own question to get the quick design help you need.

Linked content is provided "AS IS" by the respective contributors. They do not constitute TI specifications and do not necessarily reflect TI's views; see TI's [Terms of Use](#).

9.4 Trademarks

TI E2E™ is a trademark of Texas Instruments.
 All trademarks are the property of their respective owners.

9.5 Electrostatic Discharge Caution



This integrated circuit can be damaged by ESD. Texas Instruments recommends that all integrated circuits be handled with appropriate precautions. Failure to observe proper handling and installation procedures can cause damage.

ESD damage can range from subtle performance degradation to complete device failure. Precision integrated circuits may be more susceptible to damage because very small parametric changes could cause the device not to meet its published specifications.

9.6 Glossary

[TI Glossary](#) This glossary lists and explains terms, acronyms, and definitions.

10 Revision History

NOTE: Page numbers for previous revisions may differ from page numbers in the current version.

Changes from Revision B (June 2022) to Revision C (December 2024)	Page
• Added Functional Safety information to the data sheet.....	1
• Added preview SOT-23 Version R pinout to the data sheet.....	4
• Changed production data SOT-23 pinout name to SOT-23 Version A.....	4
• Added the <i>Device Nomenclature</i> section.....	36

Changes from Revision A (September 2021) to Revision B (June 2022)	Page
• Changed <i>Layout Example</i>	35

Changes from Revision * (July 2021) to Revision A (September 2021)	Page
• Removed the preview notes from the <i>Device Comparison</i> table.....	3
• Added operating supply current for the TMAG511xx4-Q1.....	6
• Added graphs to the <i>Typical Characteristics</i> section.....	7

11 Mechanical, Packaging, and Orderable Information

The following pages include mechanical, packaging, and orderable information. This information is the most current data available for the designated devices. This data is subject to change without notice and revision of this document. For browser-based versions of this data sheet, refer to the left-hand navigation.



DBV0005A-C01

PACKAGE OUTLINE
SOT-23 - 1.25 mm max height

SMALL OUTLINE TRANSISTOR

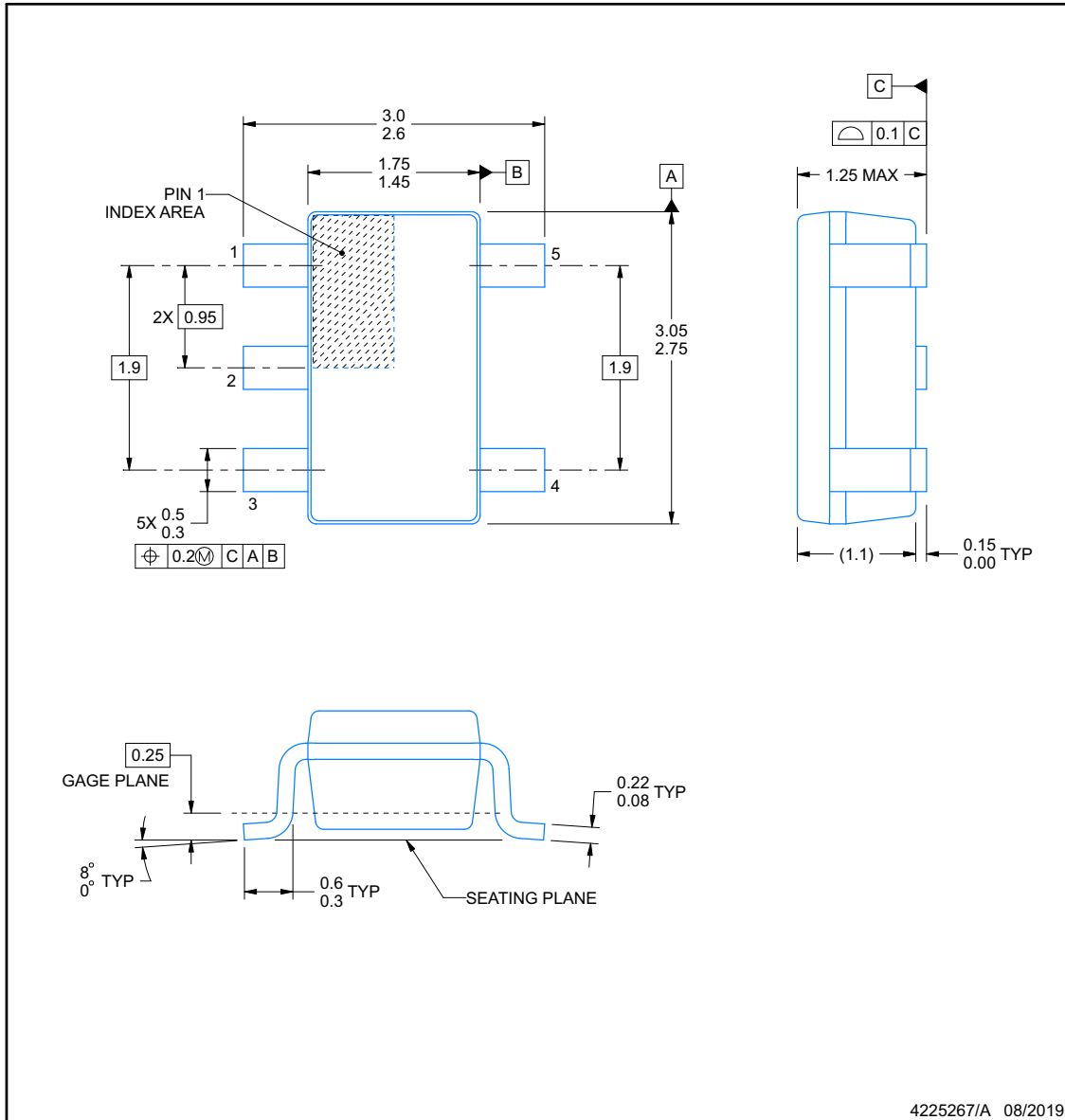

NOTES:

1. All linear dimensions are in millimeters. Any dimensions in parenthesis are for reference only. Dimensioning and tolerancing per ASME Y14.5M.
2. This drawing is subject to change without notice.
3. Reference JEDEC MO-178.
4. Body dimensions do not include mold flash, protrusions, or gate burrs. Mold flash, protrusions, or gate burrs shall not exceed 0.15 mm per side.

EXAMPLE BOARD LAYOUT

DBV0005A-C01

SOT-23 - 1.25 mm max height

SMALL OUTLINE TRANSISTOR

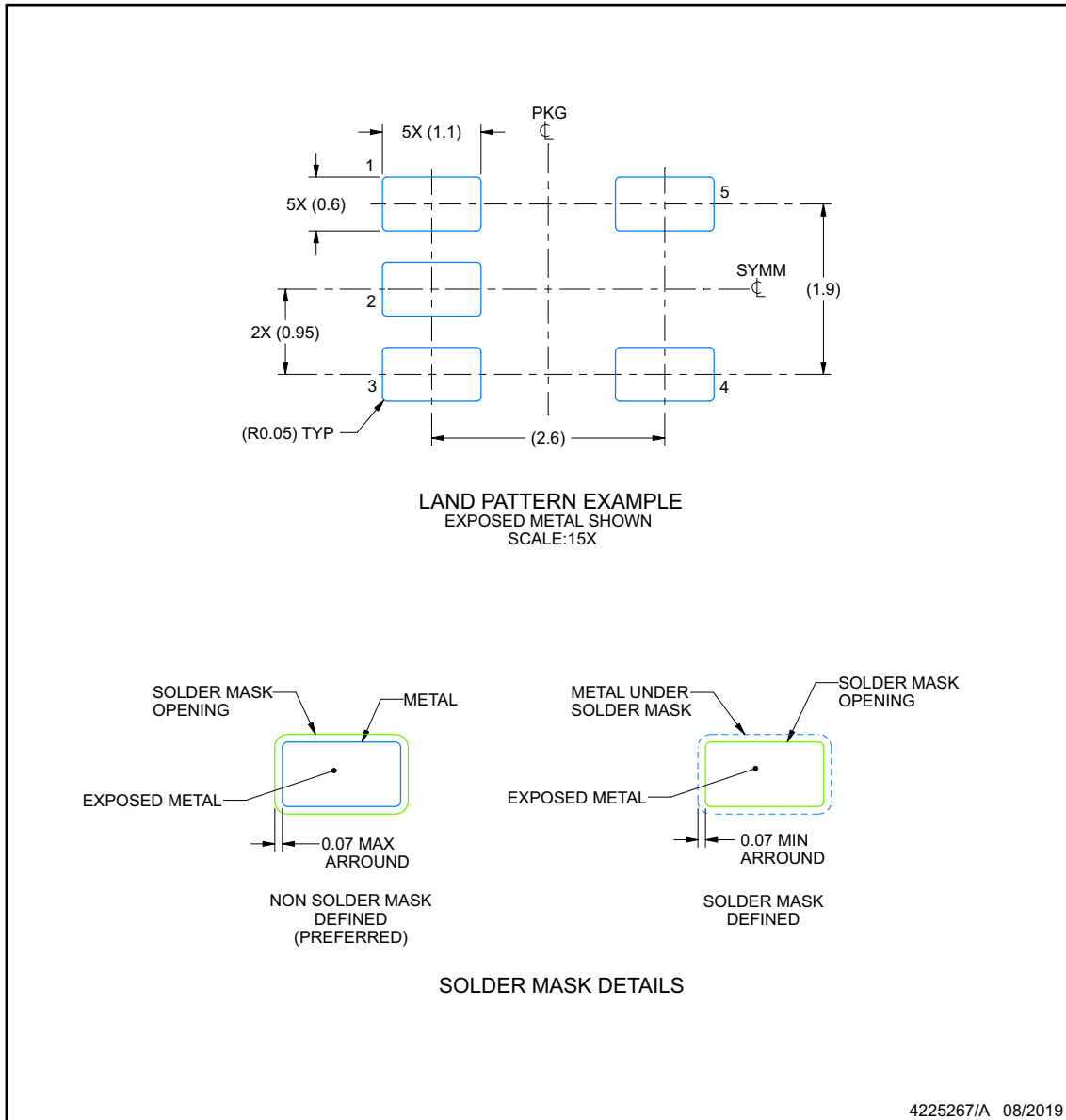

NOTES: (continued)

- 5. Publication IPC-7351 may have alternate designs.
- 6. Solder mask tolerances between and around signal pads can vary based on board fabrication site.

EXAMPLE STENCIL DESIGN

DBV0005A-C01

SOT-23 - 1.25 mm max height

SMALL OUTLINE TRANSISTOR

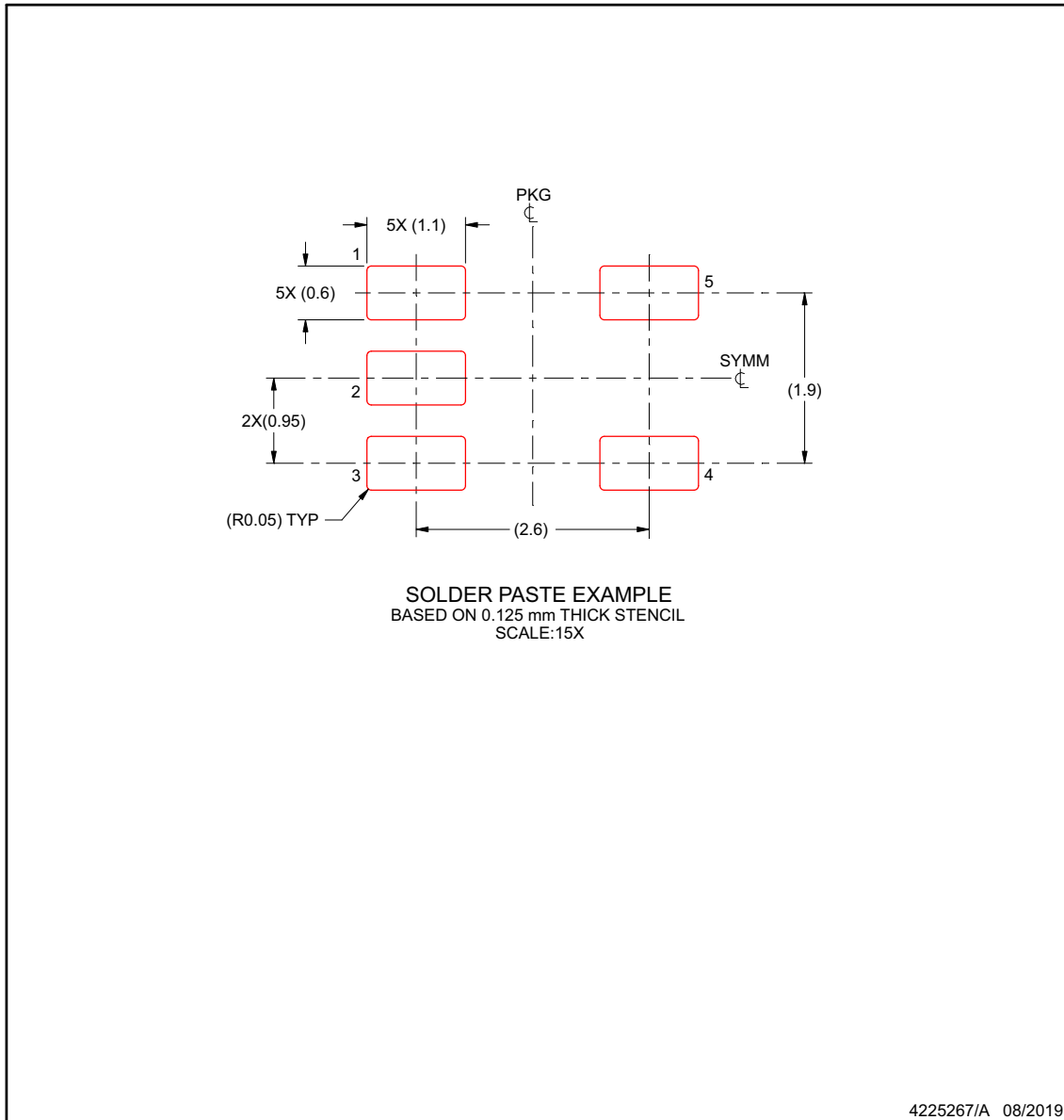

NOTES: (continued)

7. Laser cutting apertures with trapezoidal walls and rounded corners may offer better paste release. IPC-7525 may have alternate design recommendations.
8. Board assembly site may have different recommendations for stencil design.

PACKAGING INFORMATION

Orderable part number	Status (1)	Material type (2)	Package Pins	Package qty Carrier	RoHS (3)	Lead finish/ Ball material (4)	MSL rating/ Peak reflow (5)	Op temp (°C)	Part marking (6)
PMAG5110B2RQDBVRQ1	Active	Preproduction	SOT-23 (DBV) 5	3000 LARGE T&R	-	Call TI	Call TI	-40 to 125	
PMAG5110B2RQDBVRQ1.A	Active	Preproduction	SOT-23 (DBV) 5	3000 LARGE T&R	-	Call TI	Call TI	-40 to 125	
PMAG5110C2RQDBVRQ1.A	Active	Preproduction	SOT-23 (DBV) 5	3000 LARGE T&R	-	Call TI	Call TI	-40 to 125	
TMAG5110A2AQDBVRQ1	Active	Production	SOT-23 (DBV) 5	3000 LARGE T&R	Yes	SN	Level-3-260C-168 HR	-40 to 125	0A2Z
TMAG5110A2AQDBVRQ1.A	Active	Production	SOT-23 (DBV) 5	3000 LARGE T&R	Yes	SN	Level-3-260C-168 HR	-40 to 125	0A2Z
TMAG5110A4AQDBVRQ1	Active	Production	SOT-23 (DBV) 5	3000 LARGE T&R	Yes	SN	Level-3-260C-168 HR	-40 to 125	0A4Z
TMAG5110A4AQDBVRQ1.A	Active	Production	SOT-23 (DBV) 5	3000 LARGE T&R	Yes	SN	Level-3-260C-168 HR	-40 to 125	0A4Z
TMAG5110B2AQDBVRQ1	Active	Production	SOT-23 (DBV) 5	3000 LARGE T&R	Yes	SN	Level-3-260C-168 HR	-40 to 125	0B2Z
TMAG5110B2AQDBVRQ1.A	Active	Production	SOT-23 (DBV) 5	3000 LARGE T&R	Yes	SN	Level-3-260C-168 HR	-40 to 125	0B2Z
TMAG5110B4AQDBVRQ1	Active	Production	SOT-23 (DBV) 5	3000 LARGE T&R	Yes	SN	Level-3-260C-168 HR	-40 to 125	0B4Z
TMAG5110B4AQDBVRQ1.A	Active	Production	SOT-23 (DBV) 5	3000 LARGE T&R	Yes	SN	Level-3-260C-168 HR	-40 to 125	0B4Z
TMAG5110C2AQDBVRQ1	Active	Production	SOT-23 (DBV) 5	3000 LARGE T&R	Yes	SN	Level-3-260C-168 HR	-40 to 125	0C2Z
TMAG5110C2AQDBVRQ1.A	Active	Production	SOT-23 (DBV) 5	3000 LARGE T&R	Yes	SN	Level-3-260C-168 HR	-40 to 125	0C2Z
TMAG5110C2RQDBVRQ1	Active	Production	SOT-23 (DBV) 5	3000 LARGE T&R	Yes	SN	Level-1-260C-UNLIM	-40 to 125	10C2
TMAG5110C4AQDBVRQ1	Active	Production	SOT-23 (DBV) 5	3000 LARGE T&R	Yes	SN	Level-3-260C-168 HR	-40 to 125	0C4Z
TMAG5110C4AQDBVRQ1.A	Active	Production	SOT-23 (DBV) 5	3000 LARGE T&R	Yes	SN	Level-3-260C-168 HR	-40 to 125	0C4Z
TMAG5111A2AQDBVRQ1	Active	Production	SOT-23 (DBV) 5	3000 LARGE T&R	Yes	SN	Level-3-260C-168 HR	-40 to 125	1A2Z
TMAG5111A2AQDBVRQ1.A	Active	Production	SOT-23 (DBV) 5	3000 LARGE T&R	Yes	SN	Level-3-260C-168 HR	-40 to 125	1A2Z
TMAG5111A4AQDBVRQ1	Active	Production	SOT-23 (DBV) 5	3000 LARGE T&R	Yes	SN	Level-3-260C-168 HR	-40 to 125	1A4Z
TMAG5111A4AQDBVRQ1.A	Active	Production	SOT-23 (DBV) 5	3000 LARGE T&R	Yes	SN	Level-3-260C-168 HR	-40 to 125	1A4Z
TMAG5111B2AQDBVRQ1	Active	Production	SOT-23 (DBV) 5	3000 LARGE T&R	Yes	SN	Level-3-260C-168 HR	-40 to 125	1B2Z
TMAG5111B2AQDBVRQ1.A	Active	Production	SOT-23 (DBV) 5	3000 LARGE T&R	Yes	SN	Level-3-260C-168 HR	-40 to 125	1B2Z
TMAG5111B4AQDBVRQ1	Active	Production	SOT-23 (DBV) 5	3000 LARGE T&R	Yes	SN	Level-3-260C-168 HR	-40 to 125	1B4Z
TMAG5111B4AQDBVRQ1.A	Active	Production	SOT-23 (DBV) 5	3000 LARGE T&R	Yes	SN	Level-3-260C-168 HR	-40 to 125	1B4Z
TMAG5111C2AQDBVRQ1	Active	Production	SOT-23 (DBV) 5	3000 LARGE T&R	Yes	SN	Level-3-260C-168 HR	-40 to 125	1C2Z
TMAG5111C2AQDBVRQ1.A	Active	Production	SOT-23 (DBV) 5	3000 LARGE T&R	Yes	SN	Level-3-260C-168 HR	-40 to 125	1C2Z
TMAG5111C4AQDBVRQ1	Active	Production	SOT-23 (DBV) 5	3000 LARGE T&R	Yes	SN	Level-3-260C-168 HR	-40 to 125	1C4Z
TMAG5111C4AQDBVRQ1.A	Active	Production	SOT-23 (DBV) 5	3000 LARGE T&R	Yes	SN	Level-3-260C-168 HR	-40 to 125	1C4Z

(1) **Status:** For more details on status, see our [product life cycle](#).

(2) **Material type:** When designated, preproduction parts are prototypes/experimental devices, and are not yet approved or released for full production. Testing and final process, including without limitation quality assurance, reliability performance testing, and/or process qualification, may not yet be complete, and this item is subject to further changes or possible discontinuation. If available for ordering, purchases will be subject to an additional waiver at checkout, and are intended for early internal evaluation purposes only. These items are sold without warranties of any kind.

(3) **RoHS values:** Yes, No, RoHS Exempt. See the [TI RoHS Statement](#) for additional information and value definition.

(4) **Lead finish/Ball material:** Parts may have multiple material finish options. Finish options are separated by a vertical ruled line. Lead finish/Ball material values may wrap to two lines if the finish value exceeds the maximum column width.

(5) **MSL rating/Peak reflow:** The moisture sensitivity level ratings and peak solder (reflow) temperatures. In the event that a part has multiple moisture sensitivity ratings, only the lowest level per JEDEC standards is shown. Refer to the shipping label for the actual reflow temperature that will be used to mount the part to the printed circuit board.

(6) **Part marking:** There may be an additional marking, which relates to the logo, the lot trace code information, or the environmental category of the part.

Multiple part markings will be inside parentheses. Only one part marking contained in parentheses and separated by a "-" will appear on a part. If a line is indented then it is a continuation of the previous line and the two combined represent the entire part marking for that device.

Important Information and Disclaimer: The information provided on this page represents TI's knowledge and belief as of the date that it is provided. TI bases its knowledge and belief on information provided by third parties, and makes no representation or warranty as to the accuracy of such information. Efforts are underway to better integrate information from third parties. TI has taken and continues to take reasonable steps to provide representative and accurate information but may not have conducted destructive testing or chemical analysis on incoming materials and chemicals. TI and TI suppliers consider certain information to be proprietary, and thus CAS numbers and other limited information may not be available for release.

In no event shall TI's liability arising out of such information exceed the total purchase price of the TI part(s) at issue in this document sold by TI to Customer on an annual basis.

OTHER QUALIFIED VERSIONS OF TMAG5110-Q1, TMAG5111-Q1 :

- Catalog : [TMAG5110](#), [TMAG5111](#)

NOTE: Qualified Version Definitions:

- Catalog - TI's standard catalog product

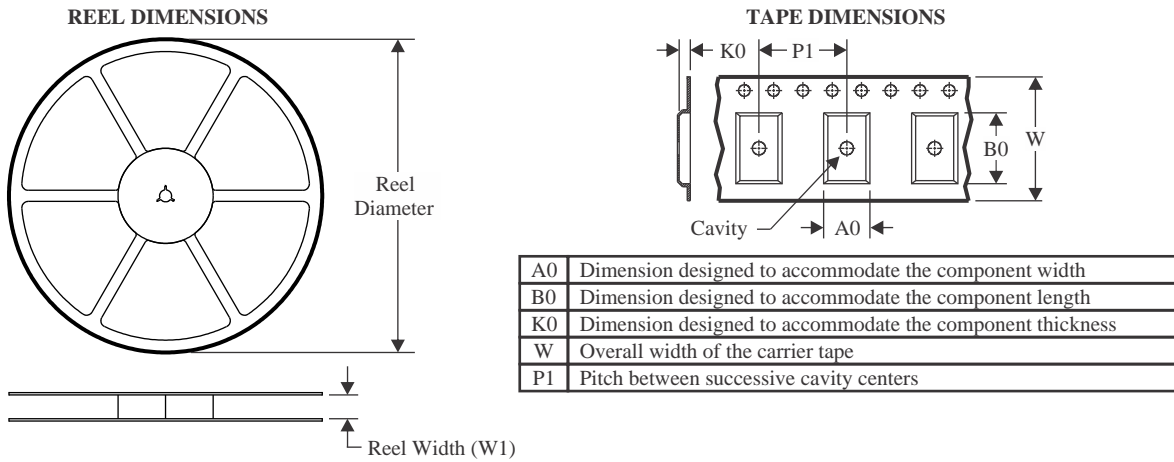
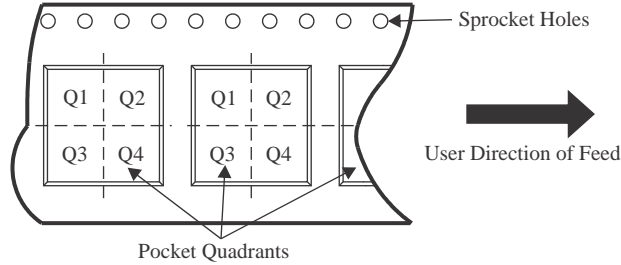
TAPE AND REEL INFORMATION

QUADRANT ASSIGNMENTS FOR PIN 1 ORIENTATION IN TAPE

*All dimensions are nominal

Device	Package Type	Package Drawing	Pins	SPQ	Reel Diameter (mm)	Reel Width W1 (mm)	A0 (mm)	B0 (mm)	K0 (mm)	P1 (mm)	W (mm)	Pin1 Quadrant
TMAG5110A2AQDBVRQ1	SOT-23	DBV	5	3000	178.0	9.0	3.3	3.2	1.4	4.0	8.0	Q3
TMAG5110A4AQDBVRQ1	SOT-23	DBV	5	3000	178.0	9.0	3.3	3.2	1.4	4.0	8.0	Q3
TMAG5110B2AQDBVRQ1	SOT-23	DBV	5	3000	178.0	9.0	3.3	3.2	1.4	4.0	8.0	Q3
TMAG5110B4AQDBVRQ1	SOT-23	DBV	5	3000	178.0	9.0	3.3	3.2	1.4	4.0	8.0	Q3
TMAG5110C2AQDBVRQ1	SOT-23	DBV	5	3000	178.0	9.0	3.3	3.2	1.4	4.0	8.0	Q3
TMAG5110C2RQDBVRQ1	SOT-23	DBV	5	3000	180.0	8.4	3.2	3.2	1.4	4.0	8.0	Q3
TMAG5110C4AQDBVRQ1	SOT-23	DBV	5	3000	178.0	9.0	3.3	3.2	1.4	4.0	8.0	Q3
TMAG5111A2AQDBVRQ1	SOT-23	DBV	5	3000	178.0	9.0	3.3	3.2	1.4	4.0	8.0	Q3
TMAG5111A4AQDBVRQ1	SOT-23	DBV	5	3000	178.0	9.0	3.3	3.2	1.4	4.0	8.0	Q3
TMAG5111B2AQDBVRQ1	SOT-23	DBV	5	3000	178.0	9.0	3.3	3.2	1.4	4.0	8.0	Q3
TMAG5111B4AQDBVRQ1	SOT-23	DBV	5	3000	178.0	9.0	3.3	3.2	1.4	4.0	8.0	Q3
TMAG5111C2AQDBVRQ1	SOT-23	DBV	5	3000	178.0	9.0	3.3	3.2	1.4	4.0	8.0	Q3
TMAG5111C4AQDBVRQ1	SOT-23	DBV	5	3000	178.0	9.0	3.3	3.2	1.4	4.0	8.0	Q3

TAPE AND REEL BOX DIMENSIONS

*All dimensions are nominal

Device	Package Type	Package Drawing	Pins	SPQ	Length (mm)	Width (mm)	Height (mm)
TMAG5110A2AQDBVRQ1	SOT-23	DBV	5	3000	190.0	190.0	30.0
TMAG5110A4AQDBVRQ1	SOT-23	DBV	5	3000	190.0	190.0	30.0
TMAG5110B2AQDBVRQ1	SOT-23	DBV	5	3000	190.0	190.0	30.0
TMAG5110B4AQDBVRQ1	SOT-23	DBV	5	3000	190.0	190.0	30.0
TMAG5110C2AQDBVRQ1	SOT-23	DBV	5	3000	190.0	190.0	30.0
TMAG5110C2RQDBVRQ1	SOT-23	DBV	5	3000	210.0	185.0	35.0
TMAG5110C4AQDBVRQ1	SOT-23	DBV	5	3000	190.0	190.0	30.0
TMAG5111A2AQDBVRQ1	SOT-23	DBV	5	3000	190.0	190.0	30.0
TMAG5111A4AQDBVRQ1	SOT-23	DBV	5	3000	190.0	190.0	30.0
TMAG5111B2AQDBVRQ1	SOT-23	DBV	5	3000	190.0	190.0	30.0
TMAG5111B4AQDBVRQ1	SOT-23	DBV	5	3000	190.0	190.0	30.0
TMAG5111C2AQDBVRQ1	SOT-23	DBV	5	3000	190.0	190.0	30.0
TMAG5111C4AQDBVRQ1	SOT-23	DBV	5	3000	190.0	190.0	30.0

IMPORTANT NOTICE AND DISCLAIMER

TI PROVIDES TECHNICAL AND RELIABILITY DATA (INCLUDING DATA SHEETS), DESIGN RESOURCES (INCLUDING REFERENCE DESIGNS), APPLICATION OR OTHER DESIGN ADVICE, WEB TOOLS, SAFETY INFORMATION, AND OTHER RESOURCES "AS IS" AND WITH ALL FAULTS, AND DISCLAIMS ALL WARRANTIES, EXPRESS AND IMPLIED, INCLUDING WITHOUT LIMITATION ANY IMPLIED WARRANTIES OF MERCHANTABILITY, FITNESS FOR A PARTICULAR PURPOSE OR NON-INFRINGEMENT OF THIRD PARTY INTELLECTUAL PROPERTY RIGHTS.

These resources are intended for skilled developers designing with TI products. You are solely responsible for (1) selecting the appropriate TI products for your application, (2) designing, validating and testing your application, and (3) ensuring your application meets applicable standards, and any other safety, security, regulatory or other requirements.

These resources are subject to change without notice. TI grants you permission to use these resources only for development of an application that uses the TI products described in the resource. Other reproduction and display of these resources is prohibited. No license is granted to any other TI intellectual property right or to any third party intellectual property right. TI disclaims responsibility for, and you will fully indemnify TI and its representatives against, any claims, damages, costs, losses, and liabilities arising out of your use of these resources.

TI's products are provided subject to [TI's Terms of Sale](#) or other applicable terms available either on [ti.com](https://www.ti.com) or provided in conjunction with such TI products. TI's provision of these resources does not expand or otherwise alter TI's applicable warranties or warranty disclaimers for TI products.

TI objects to and rejects any additional or different terms you may have proposed.

Mailing Address: Texas Instruments, Post Office Box 655303, Dallas, Texas 75265
Copyright © 2025, Texas Instruments Incorporated