

CDC6Cx Low Power LVCMOS Output BAW Oscillator

1 Features

- LVCMOS output oscillator supporting frequency range from 250kHz to 200MHz
- Total frequency stability (inclusive of all factors and including 10 years aging):
 - DLY: ± 50 ppm
 - DLX: ± 25 ppm
 - DLF: ± 25 ppm
 - DLE: ± 25 ppm
- Supply voltage supports 1.8V to 3.3V $\pm 10\%$.
- Very low power consumption: 4.57mA typical and 7.4mA maximum for 25MHz
- Stand by current 2.7 μ A typical helps for battery powered applications
- Low jitter: < 1ps RMS jitter for $F_{out} \geq 10$ MHz
- Smallest industry standard package: 1.60mm \times 1.2mm (DLY), 2.00mm \times 1.60mm (DLX), 2.50mm \times 2.00mm (DLF), 3.20mm \times 2.5mm (DLE)
- Operating temperature range: -40°C to $+105^{\circ}\text{C}$
- Integrated LDO for robust supply noise immunity
- Start-up time < 3ms
 - Contact TI for different start-up times.
- Orderable options for slow rise and fall time for EMI reduction

Standard frequencies (MHz): 2.048, 4, 5.12, 8, 10, 12, 12.288, 16, 19.2, 20, 23.5008, 24, 24.576, 25, 26, 26.2144, 27, 28.125, 29.9925, 30, 32.768, 33, 33.333, 38.4, 40, 48, 49.152, 50, 66.666, 76.8, 100, 125, 156.25, and more

- Contact TI representative for any frequency and samples needed.

2 Applications

- Crystal oscillator replacement
- [Data centers, Server, Storage](#)
- Ethernet, SAS, SATA, USB, WIFI
- [Wireless Communication](#)
- [Professional audio/video](#)
- [Factory Automation and Control](#)
- [Personal Electronics, Wearable devices, IoT](#)
- FPGA, MCU, Processor and ASIC clocking

3 Description

Texas Instruments' high-precision Bulk-Acoustic Wave (BAW) micro-resonator technology is integrated directly into a package allowing for low jitter clock circuitry. BAW is fully designed and manufactured at TI factories like other silicon-based fabrication processes.

The CDC6Cx device is a low jitter, low power, fixed-frequency oscillator which incorporates the BAW as the resonator source. The device is factory-programmed per specific frequency and function pin. With a frequency control logic and output frequency divider, the CDC6Cx is capable of producing any frequency within the specified range providing a single device family for all frequency needs.

The high-performance clocking, mechanical stability, lower power consumption, and small package options for this device are designed for reference clock and core clocks in Industrial, Telecom, Data and Enterprise Network and Personal Electronics end equipments.

Packaging Information

PART NUMBER	OUTPUT TYPE	PACKAGE ⁽¹⁾	FREQUENCY STABILITY ⁽²⁾	PACKAGE SIZE ³
CDC6Cx	LVCMOS	VSON (DLE-4)	± 25 ppm	3.20mm \times 2.50mm
		VSON (DLF-4)	± 25 ppm	2.50mm \times 2.00mm
		VSON (DLX-4)	± 25 ppm	2.00mm \times 1.60mm
		VSON (DLY-4)	± 50 ppm ± 25 ppm ⁽⁴⁾	1.60mm \times 1.20mm

- (1) For more information, see [Section 12](#).
- (2) Inclusive of all factors and 10 years aging at 25°C, for more information see [Section 6.6](#).
- (3) The package size (length \times width) is a nominal value and includes pins, where applicable.
- (4) Preview, contact TI for this frequency stability option.

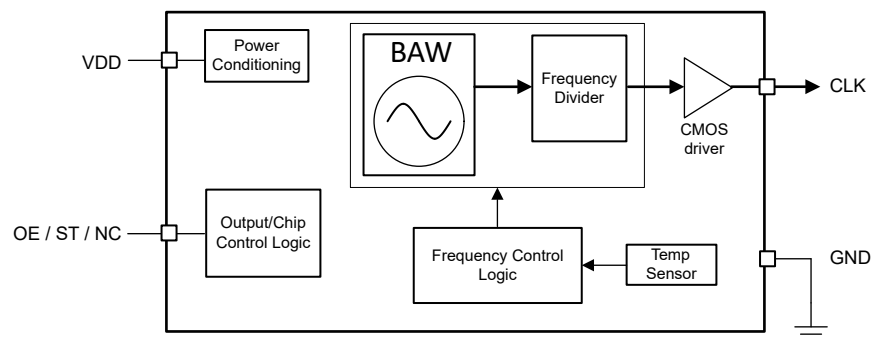

CDC6Cx Simplified Block Diagram

Table of Contents

1 Features	1	8.3 Feature Description.....	13
2 Applications	1	8.4 Device Functional Modes.....	17
3 Description	1	9 Application and Implementation	18
4 Device Comparison	3	9.1 Application Information.....	18
5 Pin Configuration and Functions	4	9.2 Typical Application.....	18
6 Specifications	5	9.3 Power Supply Recommendations.....	23
6.1 Absolute Maximum Ratings.....	5	9.4 Layout.....	24
6.2 ESD Ratings.....	5	10 Device and Documentation Support	30
6.3 Environmental Compliance.....	5	10.1 Documentation Support.....	30
6.4 Recommended Operating Conditions.....	5	10.2 Receiving Notification of Documentation Updates..	30
6.5 Thermal Information.....	6	10.3 Support Resources.....	30
6.6 Electrical Characteristics.....	6	10.4 Trademarks.....	30
6.7 Timing Diagrams.....	9	10.5 Electrostatic Discharge Caution.....	30
6.8 Typical Characteristics.....	9	10.6 Glossary.....	30
7 Parameter Measurement Information	12	11 Revision History	31
7.1 Device Output Configurations.....	12	12 Mechanical, Packaging, and Orderable Information	32
8 Detailed Description	13	12.1 Tape and Reel Information.....	45
8.1 Overview.....	13	12.2 Orderable Part Number Decoder.....	59
8.2 Functional Block Diagram.....	13		

4 Device Comparison

Use the [CDC6C OPN Decoder](#) to understand the device nomenclature of the CDC6Cx orderable options. The [CDC6C OPN Decoder](#) provides a quick summary of how to decode the frequency, package information and a list of the CDC6Cx orderable part numbers (OPNs) with associated configurations, packaging information, and device top marking.

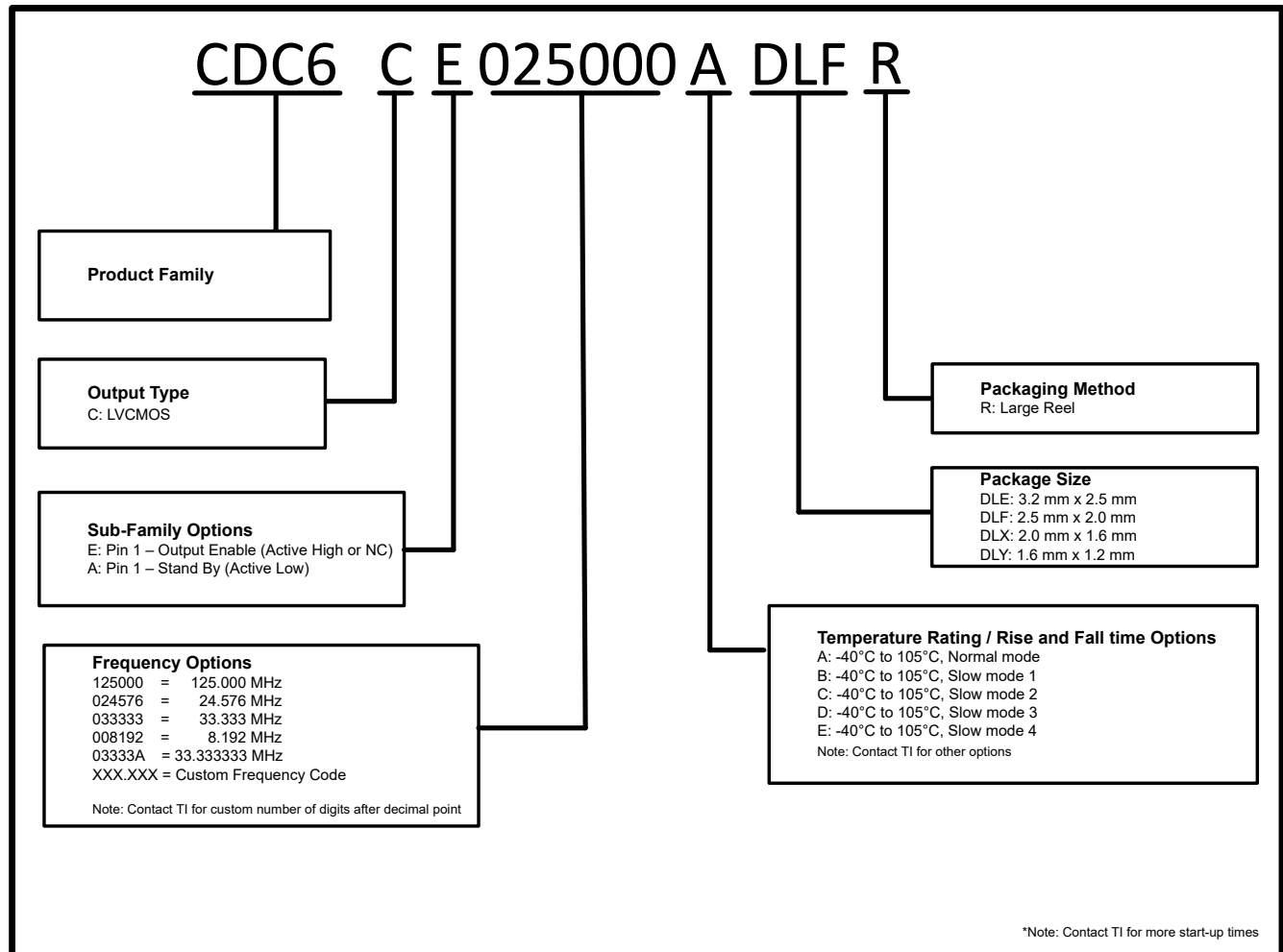

Figure 4-1. Part Number Guide: CDC6Cx

Note: Contact a TI representative to pre-order specific devices. Email: ti_osc_customer_requirement@list.ti.com

5 Pin Configuration and Functions

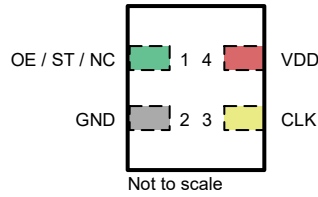

Figure 5-1. CDC6Cx 4-Pin VSON (Top View)

Legend	
Input	Power
Ground	Output

Table 5-1. CDC6Cx Pin Functions

PIN		Type ⁽¹⁾	DESCRIPTION
NAME	NO.		
OE / ST / NC	1	I / NC	Output Enable (OE) or Stand By (ST) pin on No Connect (NC). See Table 8-1 for more details.
GND	2	G	Device ground
CLK	3	O	LVC MOS output clock
VDD	4	P	Device power supply

(1) I = Input, O = Output, I/O = Input or Output, G = Ground, P = Power, NC = No Connect (can be left floating).

6 Specifications

6.1 Absolute Maximum Ratings

over operating free-air temperature range (unless otherwise noted)⁽¹⁾

		MIN	MAX	UNIT
V _{DD}	Device supply voltage ⁽²⁾	-0.3	3.63	V
EN	Logic input voltage	-0.3	3.63	V
CLK	Clock output voltage	-0.3	3.63	V
T _J	Junction temperature		130	°C
T _{STG}	Storage temperature		150	°C

- (1) Operation outside the Absolute Maximum Ratings may cause permanent device damage. Absolute Maximum Ratings do not imply functional operation of the device at these or any other conditions beyond those listed under Recommended Operating Conditions. If used outside the Recommended Operating Conditions but within the Absolute Maximum Ratings, the device may not be fully functional, and this may affect device reliability, functionality, performance, and shorten the device lifetime.
- (2) For all devices with the recommended operating voltage of 1.8V ±10%, 2.5V ±10% and 3.3V ±10%

6.2 ESD Ratings

			VALUE	UNIT
V _(ESD)	Electrostatic discharge	Human-body model (HBM), per AEC Q100-002, HBM ESD Classification Level 2	±2000	V
V _(ESD)	Electrostatic discharge	Charged-device model (CDM), per AEC Q100-011 CDM ESD Classification Level C4A	±750	V

6.3 Environmental Compliance

		VALUE	UNIT
Mechanical Vibration Resistance	MIL-STD-883F, Method 2026, Condition C	10	g
Mechanical Vibration Resistance	MIL-STD-883F, Method 2007, Condition A	20	g
Mechanical Shock Resistance	MIL-STD-883F, Method 2002, Condition A	1500	g
Moisture Sensitivity Level (MSL)		MSL1	

6.4 Recommended Operating Conditions

over operating free-air temperature range (unless otherwise noted)

		MIN	NOM	MAX	UNIT
V _{DD}	Device supply voltage ⁽¹⁾	1.62	1.8, 2.5, 3.3	3.63	V
T _A	Ambient temperature	-40		105	°C
T _J	Junction temperature			130	°C
t _{RAMP}	V _{DD} power-up ramp time ⁽²⁾	0.1		100	ms

- (1) For all devices with the recommended operating voltage of 1.8V ±10%, 2.5V ±10% and 3.3V ±10%
- (2) V_{DD} power-up ramp time is defined as minimum time taken for power supply to exceed 95% of nominal VDD. Monotonic power supply ramp is assumed.

6.5 Thermal Information

THERMAL METRIC ⁽¹⁾		CDC6C				UNIT
		DLE	DLF	DLX	DLY	
		4	4	4	4	
R _{θJA}	Junction-to-ambient thermal resistance	151.8	151.7	180.3	189.1	°C/W
R _{θJC(top)}	Junction-to-case (top) thermal resistance	89.5	99.3	116.2	137.3	°C/W
R _{θJB}	Junction-to-board thermal resistance	72.2	64.4	85.5	85	°C/W
Ψ _{JT}	Junction-to-top characterization parameter	11.1	9.2	8.5	6.2	°C/W
Ψ _{JB}	Junction-to-board characterization parameter	71.2	63.5	83.7	83.2	°C/W

(1) For more information about traditional and new thermal metrics, see the [Semiconductor and IC Package Thermal Metrics](#) application note.

6.6 Electrical Characteristics

over the recommended operating conditions ($V_{DD} = 1.8V \pm 10\%$, $2.5V \pm 10\%$, $3.3V \pm 10\%$; typical values are at 25°C unless otherwise noted)

PARAMETER		TEST CONDITIONS	MIN	TYP	MAX	UNIT
Current Consumption Characteristics						
I _{DD}	Device current consumption (excluding load current)	–40°C to 85°C, F _{out} = 20 MHz, V _{dd} = 1.8V±10%		4.22	6.7	mA
		–40°C to 85°C, F _{out} = 20 MHz, V _{dd} = 3.3V±10%		4.41	6.7	mA
		–40°C to 105°C, F _{out} = 20 MHz, V _{dd} = 1.8V±10%		4.22	7.3	mA
		–40°C to 105°C, F _{out} = 20 MHz, V _{dd} = 3.3V±10%		4.41	7.3	mA
I _{DD}	Device current consumption (excluding load current)	–40°C to 85°C, F _{out} = 25 MHz, V _{dd} = 1.8V±10%		4.32	6.8	mA
		–40°C to 85°C, F _{out} = 25 MHz, V _{dd} = 3.3V±10%		4.57	6.9	mA
		–40°C to 105°C, F _{out} = 25 MHz, V _{dd} = 1.8V±10%		4.32	7.4	mA
		–40°C to 105°C, F _{out} = 25 MHz, V _{dd} = 3.3V±10%		4.57	7.5	mA
I _{DD}	Device current consumption (excluding load current)	–40°C to 85°C, F _{out} = 50 MHz, V _{dd} = 1.8V±10%		4.84	7.1	mA
		–40°C to 85°C, F _{out} = 50 MHz, V _{dd} = 3.3V±10%		5.33	7.2	mA
		–40°C to 105°C, F _{out} = 50 MHz, V _{dd} = 1.8V±10%		4.84	7.6	mA
		–40°C to 105°C, F _{out} = 50 MHz, V _{dd} = 3.3V±10%		5.33	7.8	mA
I _{DD}	Device current consumption (excluding load current)	–40°C to 85°C, F _{out} = 100 MHz, V _{dd} = 1.8V±10%		5.86	7.6	mA
		–40°C to 85°C, F _{out} = 100 MHz, V _{dd} = 3.3V±10%		6.77	9.0	mA
		–40°C to 105°C, F _{out} = 100 MHz, V _{dd} = 1.8V±10%		5.86	8.2	mA
		–40°C to 105°C, F _{out} = 100 MHz, V _{dd} = 3.3V±10%		6.77	9.0	mA
I _{DD}	Device current consumption (excluding load current)	–40°C to 85°C, F _{out} = 150 MHz, V _{dd} = 1.8V±10%		7.14	9.5	mA
		–40°C to 85°C, F _{out} = 150 MHz, V _{dd} = 3.3V±10%		8.72	11.0	mA
		–40°C to 105°C, F _{out} = 150 MHz, V _{dd} = 1.8V±10%		7.14	9.5	mA
		–40°C to 105°C, F _{out} = 150 MHz, V _{dd} = 3.3V±10%		8.72	11.0	mA
I _{DD_stdby}	Device standby current	–40°C to 85°C, ST = GND, V _{dd} =1.8V±10%		1.5		μA
		–40°C to 85°C, ST = GND, V _{dd} =2.5V±10%		2		μA
		–40°C to 85°C, ST = GND, V _{dd} =3.3V±10%		2.7		μA
		–40°C to 105°C, ST = GND, V _{dd} =1.8V±10%		1.5		μA
		–40°C to 105°C, ST = GND, V _{dd} =2.5V±10%		2		μA
		–40°C to 105°C, ST = GND, V _{dd} =3.3V±10%		2.7		μA
I _{DD-OD}	Device current with output disabled	–40°C to 85°C, F _{out} = 25 MHz, V _{dd} = 1.8V±10%		3.75	6.4	mA
		–40°C to 85°C, F _{out} = 25 MHz, V _{dd} = 3.3V±10%		3.76	6.5	mA
		–40°C to 105°C, F _{out} = 25 MHz, V _{dd} = 1.8V±10%		3.75	7	mA
		–40°C to 105°C, F _{out} = 25 MHz, V _{dd} = 3.3V±10%		3.76	7.1	mA

6.6 Electrical Characteristics (continued)

over the recommended operating conditions ($V_{DD} = 1.8V \pm 10\%$, $2.5V \pm 10\%$, $3.3V \pm 10\%$; typical values are at 25°C unless otherwise noted)

PARAMETER		TEST CONDITIONS	MIN	TYP	MAX	UNIT
Output Characteristics						
F_{out}	Output frequency		0.25		200	MHz
V_{OL}	Output low voltage	$I_{OL} = 3.6\text{mA}$, $V_{DD} = 1.8\text{V}$			0.36	V
		$I_{OL} = 5.0\text{mA}$, $V_{DD} = 2.5\text{V}$			0.5	V
		$I_{OL} = 6.6\text{mA}$, $V_{DD} = 3.3\text{V}$			0.66	V
V_{OH}	Output high voltage	$I_{OH} = 3.6\text{mA}$, $V_{DD} = 1.8\text{V}$	$V_{DD} \times 0.88$			V
		$I_{OH} = 5.0\text{mA}$, $V_{DD} = 2.5\text{V}$	$V_{DD} \times 0.85$			V
		$I_{OH} = 6.6\text{mA}$, $V_{DD} = 3.3\text{V}$	$V_{DD} \times 0.85$			V
t_R/t_F	Output rise/fall time	20% to 80% of V_{OH} - V_{OL} , $C_L = 2\text{pF}$, normal mode, $F_{out} = 25\text{MHz}$		0.28	0.65	ns
t_R/t_F	Output rise/fall time	20% to 80% of V_{OH} - V_{OL} , $C_L = 2\text{pF}$, slow mode 1, $F_{out} = 25\text{MHz}$		0.42	0.75	ns
t_R/t_F	Output rise/fall time	20% to 80% of V_{OH} - V_{OL} , $C_L = 5\text{pF}$, normal mode, $F_{out} = 25\text{MHz}$		0.33	0.8	ns
t_R/t_F	Output rise/fall time	20% to 80% of V_{OH} - V_{OL} , $C_L = 5\text{pF}$, slow mode 2, $F_{out} = 25\text{MHz}$		1.11	2.0	ns
t_R/t_F	Output rise/fall time	20% to 80% of V_{OH} - V_{OL} , $C_L = 10\text{pF}$, normal mode, $F_{out} = 25\text{MHz}$		0.44	1.7	ns
t_R/t_F	Output rise/fall time	20% to 80% of V_{OH} - V_{OL} , $C_L = 10\text{pF}$, slow mode 3, $F_{out} = 25\text{MHz}$		1.85	3.1	ns
t_R/t_F	Output rise/fall time	20% to 80% of V_{OH} - V_{OL} , $C_L = 15\text{pF}$, normal mode, $F_{out} = 25\text{MHz}$		0.87	2.2	ns
t_R/t_F	Output rise/fall time	20% to 80% of V_{OH} - V_{OL} , $C_L = 15\text{pF}$, slow mode 4, $F_{out} = 25\text{MHz}$		2.7	4.0	ns
ODC	Output duty cycle		45	50	55	%
PN-Floor	Output phase noise floor ($f_{OFFSET} > 10\text{MHz}$)	$F_{out} = 50\text{MHz}$		-155		dBc/Hz
C_L	Maximum capacitive load	$F_{out} < 50\text{MHz}$			30	pF
C_L		$F_{out} > 50\text{MHz}$			15	pF
$R_{out-high}$	Output impedance		37.5	50	62.5	Ω
Function Pin Characteristics (OE/ST)						
V_{IL}	Input low voltage				0.6	V
V_{IH}	Input high voltage		1.3			V
I_{IL}	Input low current	EN = GND	-40			μA
I_{IH}	Input high current	EN = VDD			40	μA
C_{IN}	Input capacitance ⁽¹⁾			2		pF
Frequency Tolerance						
F_T	Total frequency stability	For DLE, DLF, and DLX packages only. Inclusive of: solder shift, initial tolerance, variation over -40°C to 105°C , variation over supply voltage range, and 10 years aging at 25°C .			± 25	ppm
F_T	Total frequency stability	For DLE, DLF, and DLX packages only. Inclusive of: solder shift, initial tolerance, variation over -40°C to 105°C , variation over supply voltage range, and 1st year aging at 25°C .			± 20	ppm

6.6 Electrical Characteristics (continued)

over the recommended operating conditions ($V_{DD} = 1.8V \pm 10\%$, $2.5V \pm 10\%$, $3.3V \pm 10\%$; typical values are at 25°C unless otherwise noted)

PARAMETER		TEST CONDITIONS	MIN	TYP	MAX	UNIT
F_T	Total frequency stability	For DLY package only. Inclusive of: solder shift, initial tolerance, variation over -40°C to 105°C , variation over supply voltage range, and 10 years aging at 25°C .			± 50	ppm
F_T	Total frequency stability	For DLY package only. Inclusive of: solder shift, initial tolerance, variation over -40°C to 105°C , variation over supply voltage range, and 1st year aging at 25°C .			± 45	ppm
F_T	Total frequency stability	For DLE, DLF, and DLX packages only. Inclusive of: solder shift, initial tolerance, variation over -40°C to 85°C , variation over supply voltage range, and 10 years aging at 25°C .			± 25	ppm
F_T	Total frequency stability	For DLE, DLF, and DLX packages only. Inclusive of: solder shift, initial tolerance, variation over -40°C to 85°C , variation over supply voltage range, and 1st year aging at 25°C .			± 20	ppm
F_T	Total frequency stability	For DLY package only. Inclusive of: solder shift, initial tolerance, variation over -40°C to 85°C , variation over supply voltage range, and 10 years aging at 25°C .			± 50	ppm
F_T	Total frequency stability	For DLY package only. Inclusive of: solder shift, initial tolerance, variation over -40°C to 85°C , variation over supply voltage range, and 1st year aging at 25°C .			± 45	ppm
PSRR Characteristics						
PSRR	Spur induced by 50mV power supply ripple at 50MHz output, $V_{DD} = 2.5V/3.3V$, no power supply decoupling capacitor	Sine wave at 50kHz			-80	dBc
		Sine wave at 100kHz			-75	dBc
		Sine wave at 500kHz			-63	dBc
		Sine wave at 1MHz			-59	dBc
Power-On Characteristics						
$t_{\text{START_UP}}$	Start-up time	Time elapsed from $0.95 \times V_{DD}$ until output is enabled and output is within specification. OE / ST = High; Tested with a power supply ramp time of $200\mu\text{s}$		1.5	3	ms
t_{RESUME}	Chip resume time	Time elapsed from $ST = V_{IH}$ until output is enabled and output is within specification			3	ms
$t_{\text{ST-DIS}}$	Chip disable time	Time elapsed from $ST = V_{IL}$ until chip is in standby mode; for $F_{\text{out}} > 100\text{MHz}$			250	ns
$t_{\text{OE-EN}}$	Output enable time	Time elapsed from $OE = V_{IH}$ until output is enabled and output is within specification; for $F_{\text{out}} > 100\text{MHz}$			250	ns
$t_{\text{OE-DIS}}$	Output disable Time	Time elapsed from $OE = V_{IL}$ until output is disabled; for $F_{\text{out}} > 100\text{MHz}$			250	ns
Clock Output Jitter						
R_J	Random phase jitter	$10\text{MHz} \leq F_{\text{out}} < 25\text{MHz}$, integration BW: 12kHz - 5MHz, maximum temperature = 105°C		400	1000	fs
R_J	Random phase jitter	$25\text{MHz} \leq F_{\text{out}} \leq 200\text{MHz}$, integration BW: 12kHz - 20MHz, maximum temperature = 105°C		400	1000	fs
$\text{SPN}_{100\text{k}}$	Spot phase noise at 1kHz offset	$F_{\text{out}} = 100\text{MHz}$			-86	dBc/Hz
$\text{SPN}_{100\text{k}}$	Spot phase noise at 10kHz offset	$F_{\text{out}} = 100\text{MHz}$			-120	dBc/Hz
$\text{SPN}_{100\text{k}}$	Spot phase noise at 100kHz offset	$F_{\text{out}} = 100\text{MHz}$			-138	dBc/Hz
$\text{SPN}_{1\text{M}}$	Spot phase noise at 1MHz offset	$F_{\text{out}} = 100\text{MHz}$			-143	dBc/Hz
$R_{\text{JITT,RMS}}$	RMS period jitter	$F_{\text{out}} \geq 25\text{MHz}$		3		ps
$R_{\text{JITT,PK}}$	Peak-peak period jitter	$F_{\text{out}} \geq 25\text{MHz}$		26		ps

(1) Proven by Design. Not characterised

6.7 Timing Diagrams

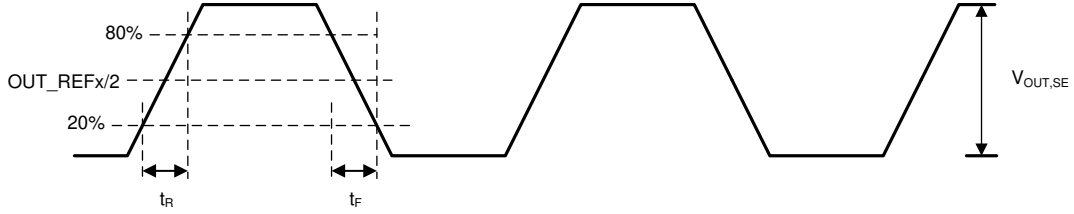

Figure 6-1. Single-Ended Output Voltage and Rise/Fall Time

6.8 Typical Characteristics

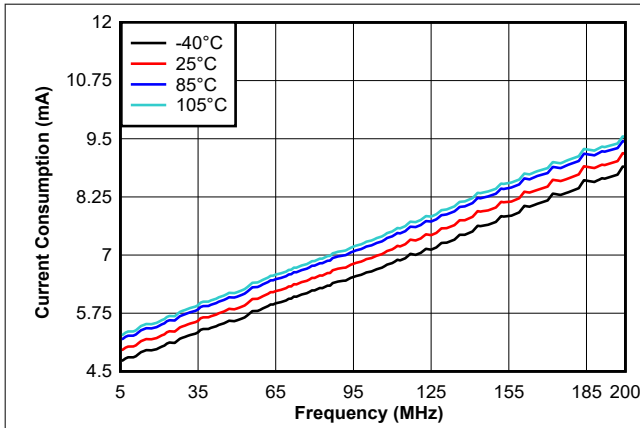

Figure 6-2. Current Consumption vs Frequency and Temperature at 1.8V Supply

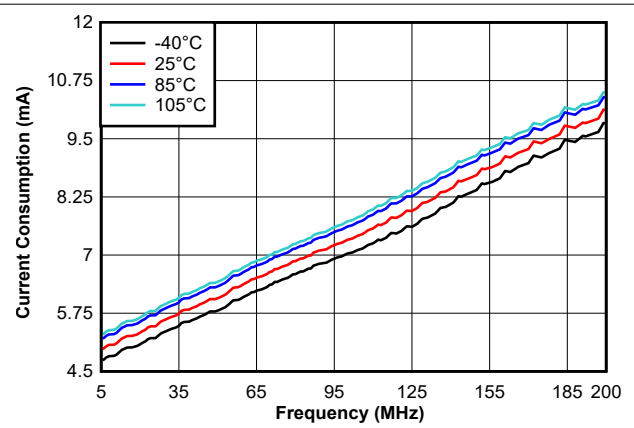

Figure 6-3. Current Consumption vs. Frequency and Temperature at 2.5V Supply

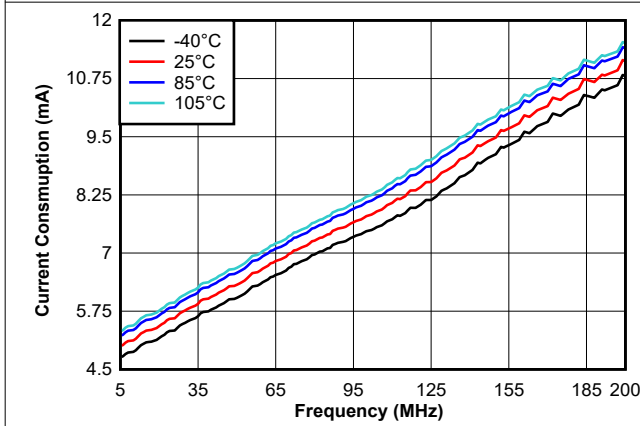

Figure 6-4. Current Consumption vs Frequency and Temperature at 3.3V Supply

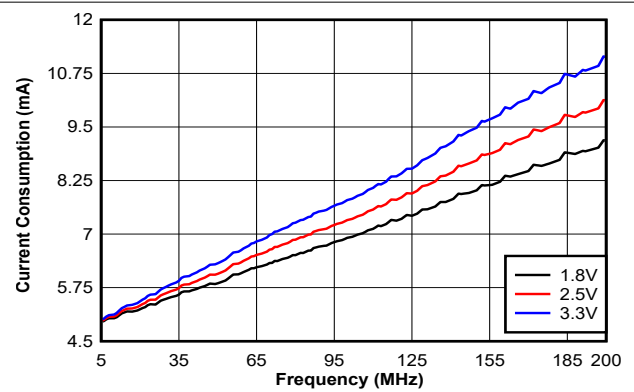

Figure 6-5. Current Consumption vs Frequency and Supply Voltage at 25°C

6.8 Typical Characteristics (continued)

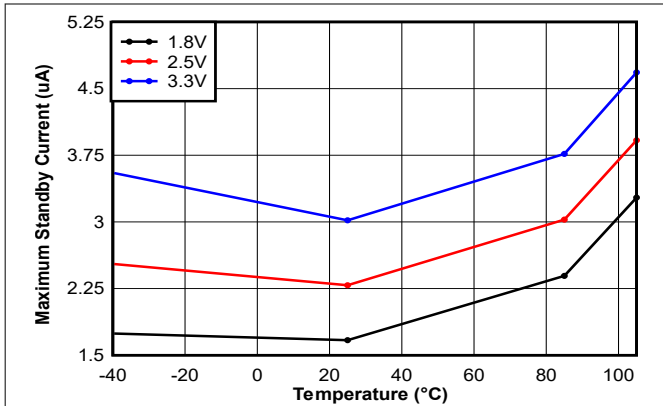

Figure 6-6. Maximum Standby Current vs Temperature and Supply Voltage

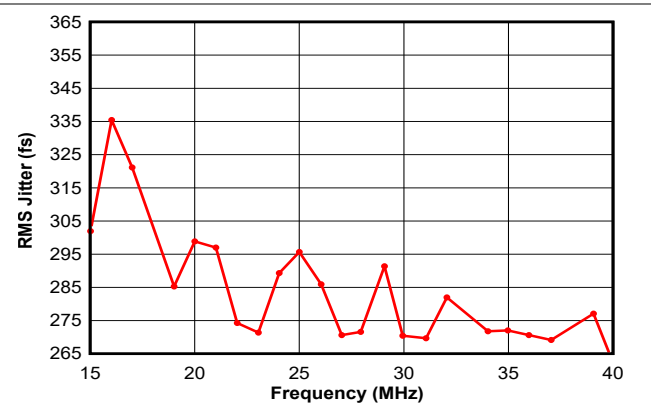

Figure 6-7. Typical RMS Jitter vs Frequency at 3.3V Supply and 25°C (BW 12kHz to 5MHz)

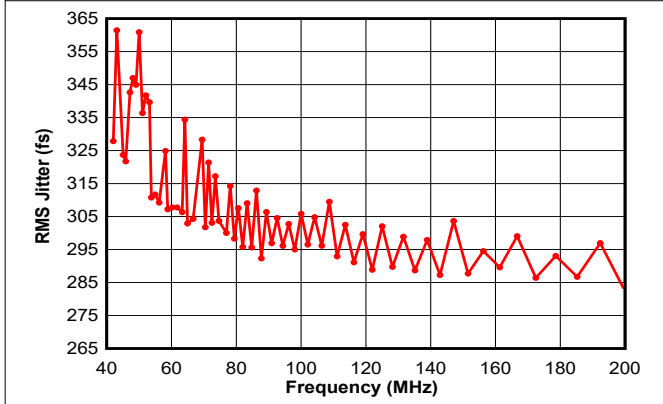

Figure 6-8. Typical RMS Jitter vs Frequency at 3.3V Supply and 25°C (BW 12kHz to 20MHz)

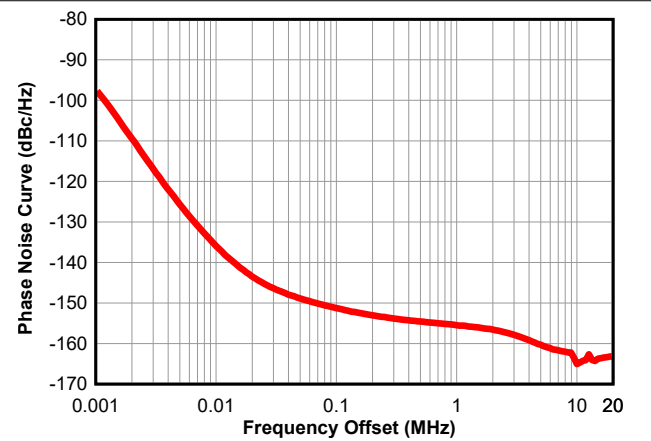

Figure 6-9. Phase Noise Curve at 25MHz, 25°C, and 3.3V Supply

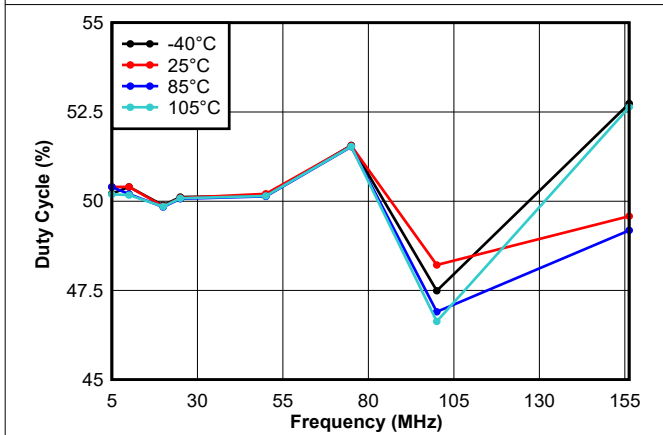

Figure 6-10. Duty Cycle vs Frequency and Temperature at 3.3V Supply, No Capacitive Load, Normal Mode Device

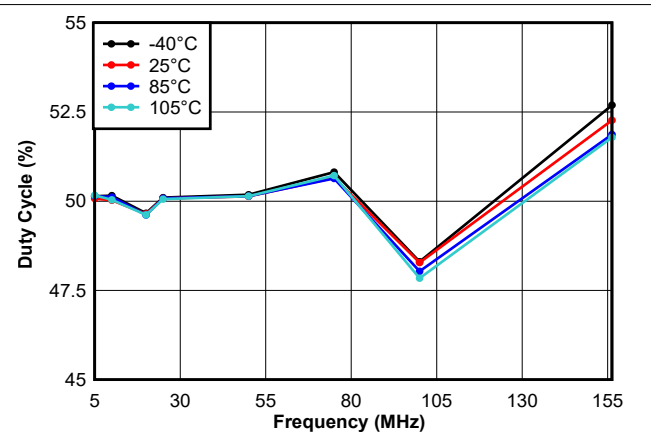
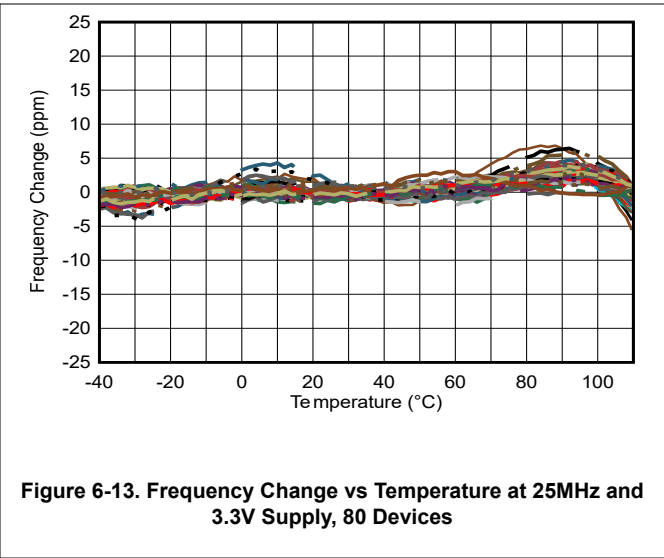
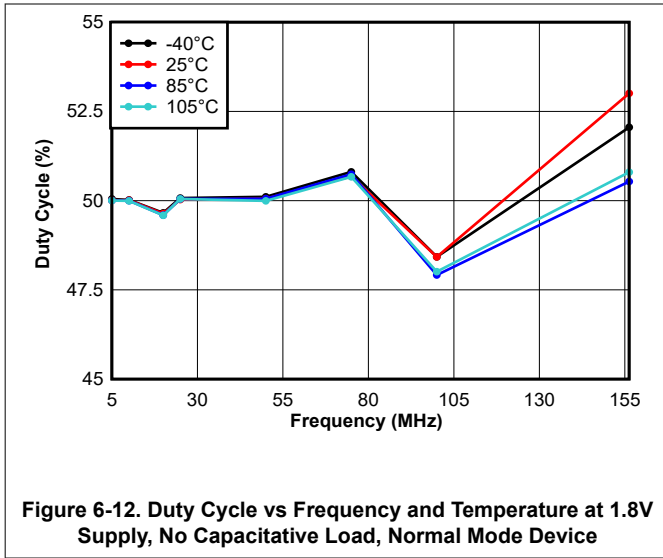

Figure 6-11. Duty Cycle vs Frequency and Temperature at 2.5V Supply, No Capacitive Load, Normal Mode Device

6.8 Typical Characteristics (continued)



7 Parameter Measurement Information

7.1 Device Output Configurations

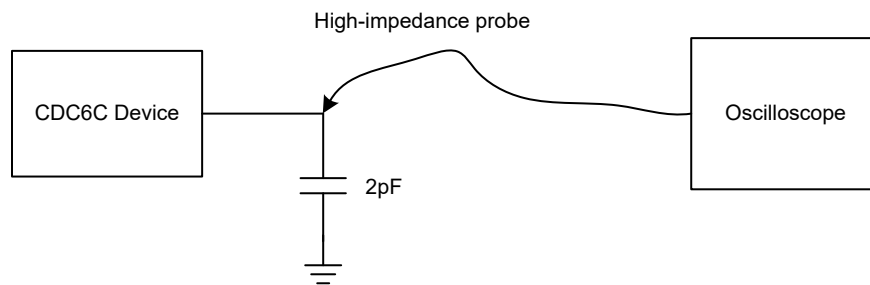

Load capacitor modified based on measurement condition.

Figure 7-1. CDC6Cx Output Test Configuration

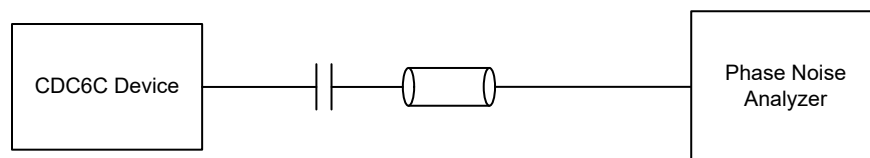

Figure 7-2. CDC6Cx Output Phase Noise Test Configuration

8 Detailed Description

8.1 Overview

The CDC6Cx is a fixed-frequency, BAW based oscillator that supports a CMOS output format within the range of 250kHz to 200MHz.

8.2 Functional Block Diagram

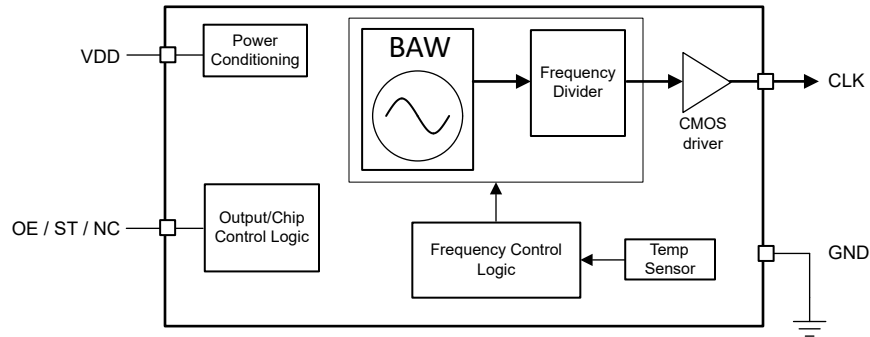

8.3 Feature Description

8.3.1 Bulk Acoustic Wave (BAW)

TI's BAW resonator technology uses piezoelectric transduction to generate high-Q resonance at 2.5GHz. The resonator is defined by the quadrilateral area overlaid by top and bottom electrodes. Alternating high-acoustic and low-acoustic impedance layers form acoustic mirrors beneath the resonant body to prevent acoustic energy leakage into the substrate. Furthermore, these acoustic mirrors are also placed on top of the resonator stack to protect the device from contamination and minimize energy leakage into the package materials. This unique dual-Bragg acoustic resonator (DBAR) allows efficient excitation without the need of costly vacuum cavities around the resonator. As a result, TI's BAW resonator is immune to frequency drift caused by absorption of surface contaminants and can be directly placed in a non-hermetic plastic package with the oscillator IC in small standard oscillator footprints.

8.3.2 Device Block-Level Description

The device contains a BAW oscillator, frequency divider and CMOS driver which together generates a pre-programmed output frequency. Temperature variations of oscillation frequency are continuously monitored by internal precision temperature sensor and provided as input to the frequency control logic block. Using this Frequency Control Logic block, frequency corrections are performed internally for maintaining the output frequency within ± 25 ppm for DLX, DLF, and DLE packages and ± 50 ppm for DLY package across temperature range and aging. The device contains an internal LDO which reduces the power supply noise, resulting in low noise clock output.

8.3.3 Function Pin

Pin 1 on the CDC6Cx is the function pin which have multiple functions based on the orderable part number. The function can be used as Output Enable (OE), Stand By (ST) or No Connect (NC). Options for both Active High and Active Low are available for OE and ST. Contact TI for Active Low options. [Table 8-1](#) lists the functions of pin 1.

Table 8-1. Function Pin Descriptions for CDC6Cx

ORDERABLE OPTION	PIN DESCRIPTION	OUTPUT FUNCTION
E (Pin 1)	Output Enable (Active High / NC)	HIGH or No Connect : Output active at Specified Frequency LOW : Output disabled, high impedance; current consumption is given by I_{DD-PD}

Table 8-1. Function Pin Descriptions for CDC6Cx (continued)

ORDERABLE OPTION	PIN DESCRIPTION	OUTPUT FUNCTION
A (Pin 1)	Standby (Active Low)	LOW : High Impedance; standby mode; current consumption is given by standby current $I_{DD-STBY}$ HIGH or No Connect : Output active at Specified Frequency

In standby mode, all blocks are powered down to provide a maximum current consumption savings equivalent to the standby current provided in the *Current Consumption Characteristics* portion of the [Section 6.6](#) table. The return to the output clock active time corresponds to the same as the initial start-up time.

The function pin is driven internally with resistance >100 kΩ.

8.3.4 Clock Output Interfacing and Termination

The following figure shows the recommended output interfacing and termination circuits.

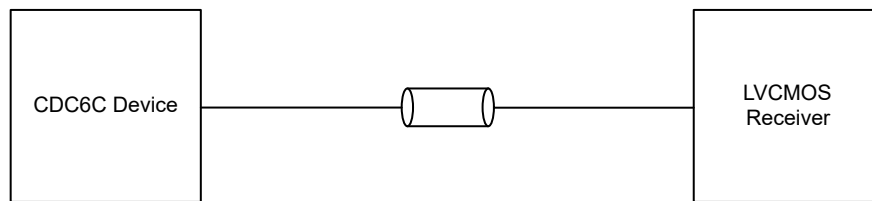

Figure 8-1. CDC6Cx Output to LVCMOS Receiver

8.3.5 Temperature Stability

[Figure 8-2](#) shows the CDC6Cx frequency change across temperature. The figure illustrates the frequency change of 80 different devices at different temperatures across the temperature range of -40°C to 105°C. This demonstrates the typical temperature stability of the device, remaining below ±10ppm.

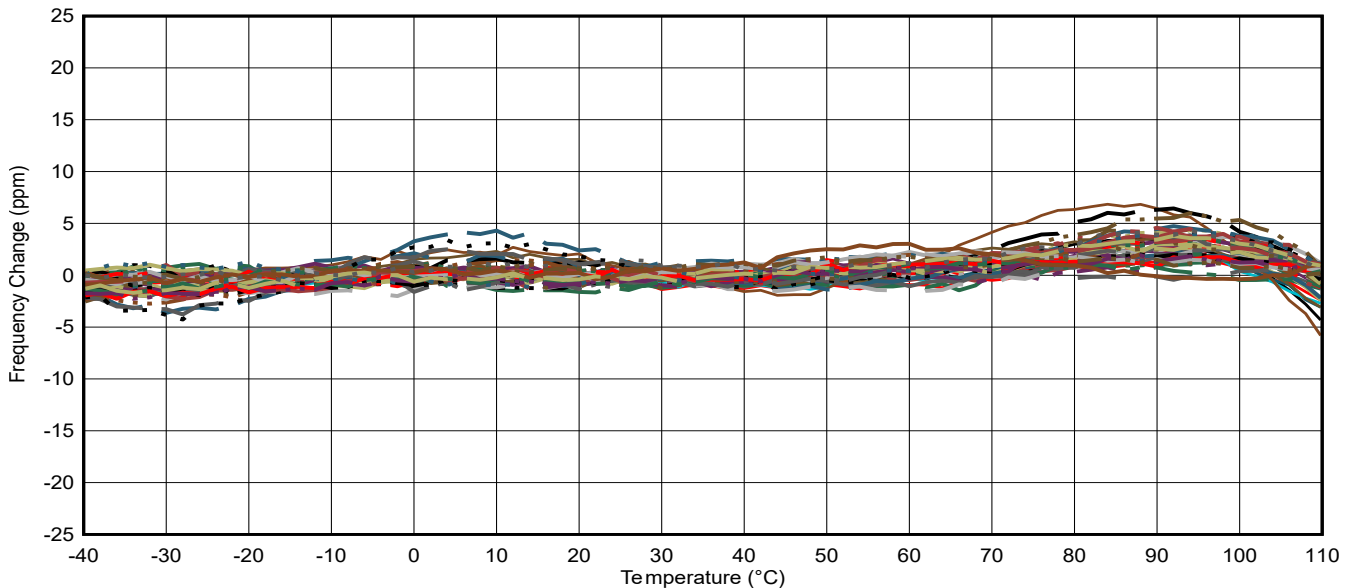

Figure 8-2. Typical Frequency Change From 25MHz Over Temperature Over 80 Devices

8.3.6 Mechanical Robustness

For reference oscillators, vibration and shock are common causes for increased phase noise and jitter, frequency shift and spikes, or even physical damages to the resonator and package. Compared to quartz

crystals, the BAW resonator is more immune to vibration and shock due to the orders of magnitude smaller mass and higher frequency—that is force applied to the device from acceleration is much smaller due to smaller mass.

Figure 8-3 shows the CDC6Cx BAW oscillator vibration performance. TI followed MIL-STD-883 Method 2026 Conditions C (10g) and Method 2007 Condition A (20g) for testing. In this test, the CDC6Cx oscillator is mounted on an EVM and subjected to a 10g acceleration force, ranging from 50Hz to 2kHz in the x, y, and z-axis. Phase noise trace with spur due to vibration is captured using Keysight E5052B and frequency deviation is calculated from the spur power. Then the frequency deviation is converted to ppb by noting the carrier frequency and normalized to ppb/g. Finally, the RMS sum of ppb/g along all three axes is reported as the Vibration sensitivity in ppb/g. CDC6Cx performance under vibration is approximately 2ppb/g while most quartz oscillators best case is 3ppb/g and worse can be above 10ppb/g.

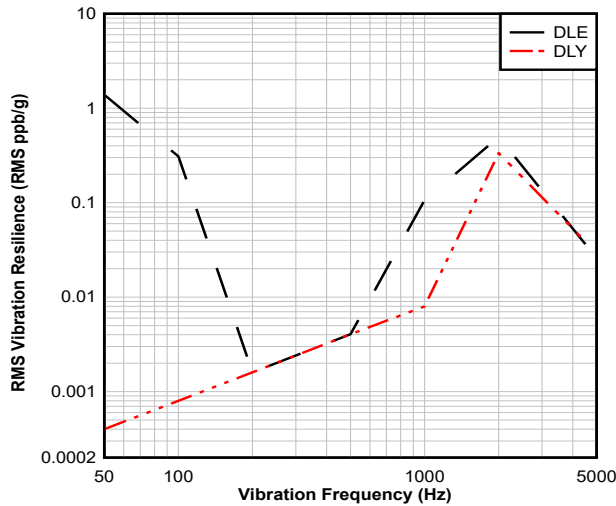

Figure 8-3. Vibration Resilience vs. Vibration Frequency at 25MHz, 25°C, Supply 1.8V - X-Axis

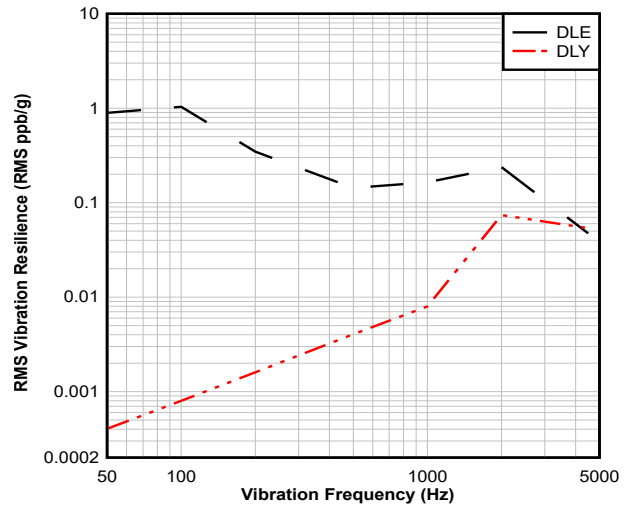

Figure 8-4. Vibration Resilience vs. Vibration Frequency at 25MHz, 25°C, Supply 1.8V - Y-Axis

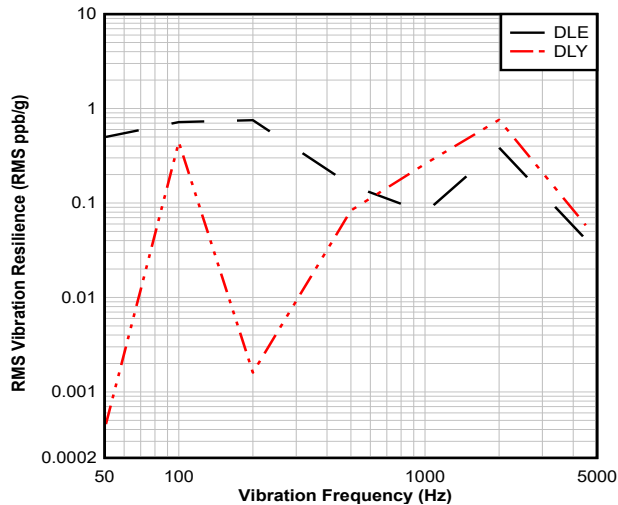

Figure 8-5. Vibration Resilience vs. Vibration Frequency at 25MHz, 25°C, Supply 1.8V - Z-Axis

For the mechanical shock test, TI followed MIL-STD-883F Method 2002 Condition A (1500g) for testing. For more information on BAW technology mechanical robustness, see the [Standalone BAW Oscillators Advantages Over Quartz Oscillators application note](#).

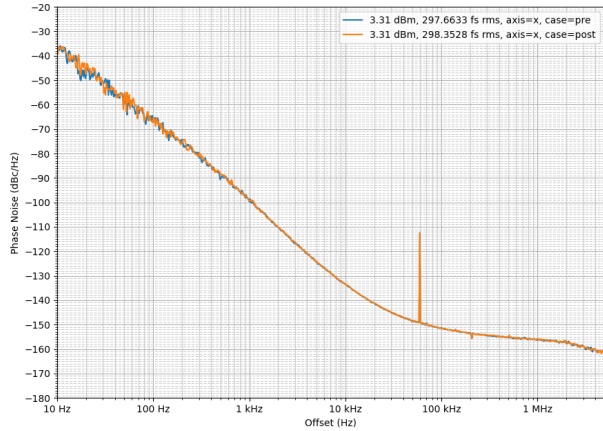

Figure 8-6. Pre and Post 1500g Mechanical Shock at 25MHz and 25°C, X-Axis

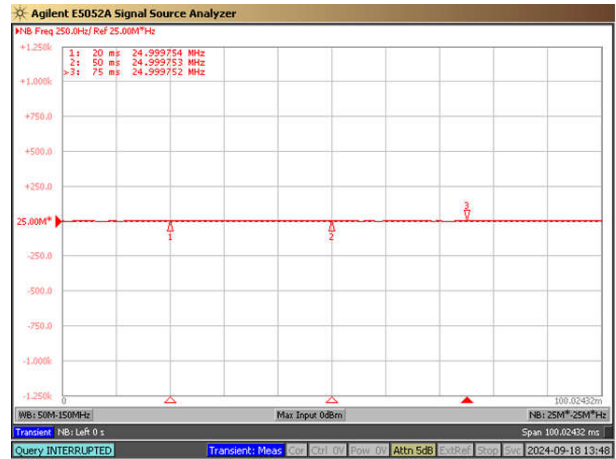

Figure 8-7. During 1500g Mechanical Shock at 25MHz and 25°C, X-Axis

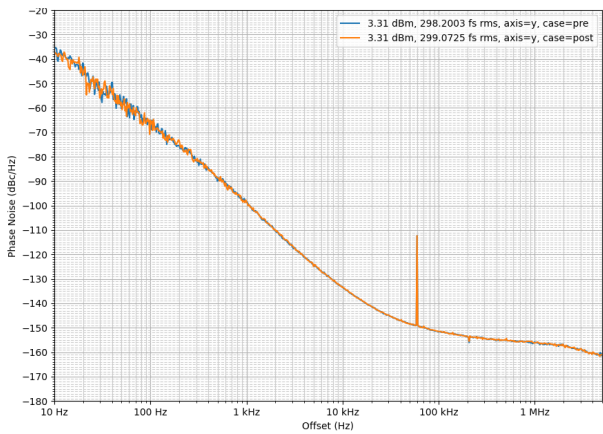

Figure 8-8. Pre and Post 1500g Mechanical Shock at 25MHz and 25°C, Y-Axis

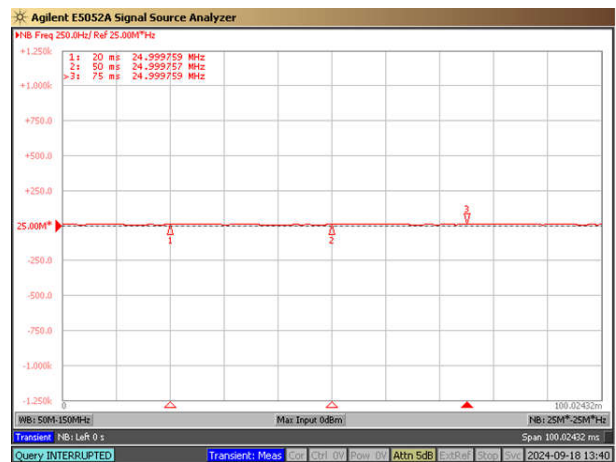

Figure 8-9. During 1500g Mechanical Shock at 25MHz and 25°C, Y-Axis

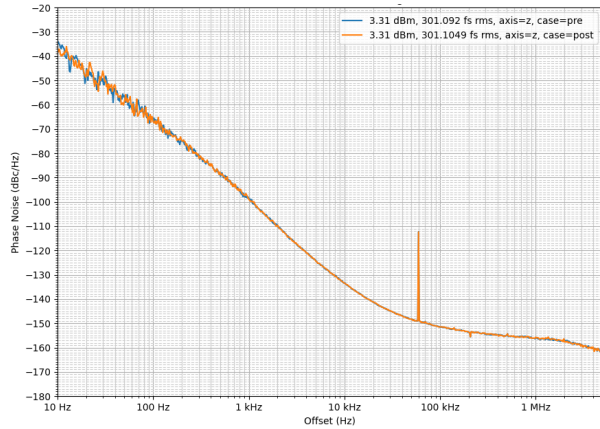

Figure 8-10. Pre and Post 1500g Mechanical Shock at 25MHz and 25°C, Z-Axis

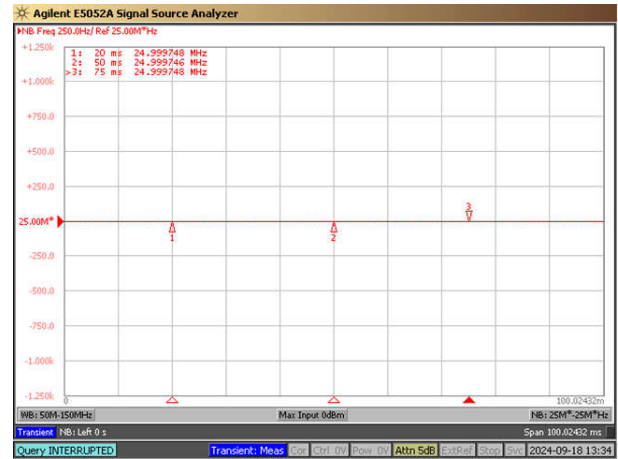

Figure 8-11. During 1500g Mechanical Shock at 25MHz and 25°C, Z-Axis

8.4 Device Functional Modes

The CDC6Cx BAW Oscillator is a fixed-frequency device and does not require any programming. The device pin 1 has different functions. See the [Function Pin](#) section for more information on the function pins.

9 Application and Implementation

Note

Information in the following applications sections is not part of the TI component specification, and TI does not warrant its accuracy or completeness. TI's customers are responsible for determining suitability of components for their purposes, as well as validating and testing their design implementation to confirm system functionality.

9.1 Application Information

The CDC6Cx is a low power, fixed frequency oscillator that can be used as a reference clock. The device supports any output frequency between 250kHz to 200MHz, single-ended output type, and 1.8V to 3.3V supply rails.

9.1.1 Driving Multiple Loads With a Single CDC6Cx

The CDC6Cx oscillator can be used to drive multiple loads to achieve cost reduction and BOM simplification. Be aware that using this technique degrades signal integrity and decreases performance. A good set of guidelines to follow when driving multiple loads include aiming to drive only two loads, maximizing common trace lengths across loads, and limiting total receiver capacitance to maximize fast rise and fall times. For more information on the effects of this technique and an implementation guide, see the [Driving Multiple Loads With a Single LVCMOS Oscillator application note](#).

9.1.2 CDC6Cx CISPR25 Radiated Emission Performance

The CDC6Cx radiated EMI emissions performance passed up to CISPR-25 Class 5. The test observed 1.8V and 3.3V, 25MHz CDC6Cx oscillators in the DLE and DLY packages. The CDC6Cx is configured for slow mode 2 with a 5pF termination and slow mode 4 with a 15pF termination. The boards used have 50mil trace lengths or immediate termination, and the boards are tested in Texas Instruments' pre-compliant EMI chamber set up for CISPR-25 with antennas operating up to 1GHz. See also [CDC6Cx CISPR25 Radiated Emission Performance Report](#).

9.2 Typical Application

For a reference schematic implementation for CDC6Cx oscillator, see the [Layout Examples](#) for bypass capacitor and AC-coupling capacitor value recommendations. See the [Clock Output Interfacing and Termination](#) section for output clock required termination and biasing.

Figure 9-1 shows a typical application example. The CDC6Cx oscillator is used as a reference clock for a microcontroller or an FPGA in this example.

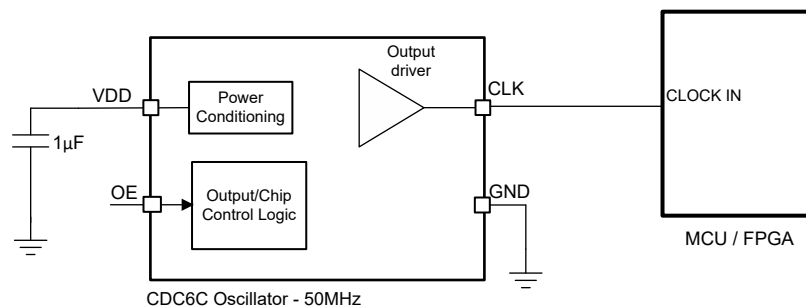

Figure 9-1. CDC6Cx Application Example

9.2.1 Design Requirements

The CDC6Cx is a fixed-frequency oscillator with no programming needed. Make sure to follow the recommended termination options as described in the [Clock Output Interfacing and Termination](#) section closely. See the

[Function Pin](#) section to understand the pin 1 function, and order the part number as per your requirements for Output Enable (OE), Standby (ST) options.

9.2.2 Detailed Design Procedure

The CDC6Cx has an integrated LDO and has excellent PSRR performance as shown in the [Section 6.6](#) table. See the [CDC6CEVM User's Guide](#) for the reference layout recommendation while designing with the CDC6Cx BAW oscillator.

To set the pin 1 function for the CDC6Cx, connect typical 10kΩ or smaller resistor to VDD for driving the OE pin High. The device has an internal pullup resistor > 100kΩ, therefore this pin can be left open if an external pullup resistor is not desired. For driving the OE pin to Low, use the typical 10kΩ or smaller resistor as a pulldown resistor.

For EMI reduction, the CDC6Cx has orderable options to reduce rise and fall times. For applications requiring lesser EMI, select the appropriate rise and fall time options and see the [CDC6Cx CISPR25 Radiated Emission Performance Report](#) for more EMI reduction strategies.

The CDC6Cx has four slow mode options other than the normal mode. Based on the desired rise and fall times, select the right slow mode option and load capacitance value between 2pF, 5pF, 10pF and 15pF. [Table 9-1](#) has recommended slow mode options for various load capacitance. For example, with load capacitance 15pF, Slow Mode 4 option results in the slowest rise and fall times. You can also select Slow Mode 1, Slow Mode 2, or Slow Mode 3 with 15pF but the rise and fall times are faster. The values in [Table 9-1](#) are obtained using a 25MHz CDC6Cx.

Table 9-1. Rise / Fall Time Options (25MHz Output)

SLOW MODE OPTION	LOAD CAPACITANCE	RISE / FALL TIME (ns) WITH SLOW MODE (TYP / MAX)	RISE / FALL TIME (ns) WITH NORMAL MODE (TYP / MAX)
Slow Mode 1	2pF	0.42 / 0.75	0.28 / 0.65
Slow Mode 2	5pF	1.11 / 2.0	0.33 / 0.8
Slow Mode 3	10pF	1.85 / 3.1	0.44 / 1.7
Slow Mode 4	15pF	2.7 / 4.0	0.87 / 2.2

9.2.3 Application Curves

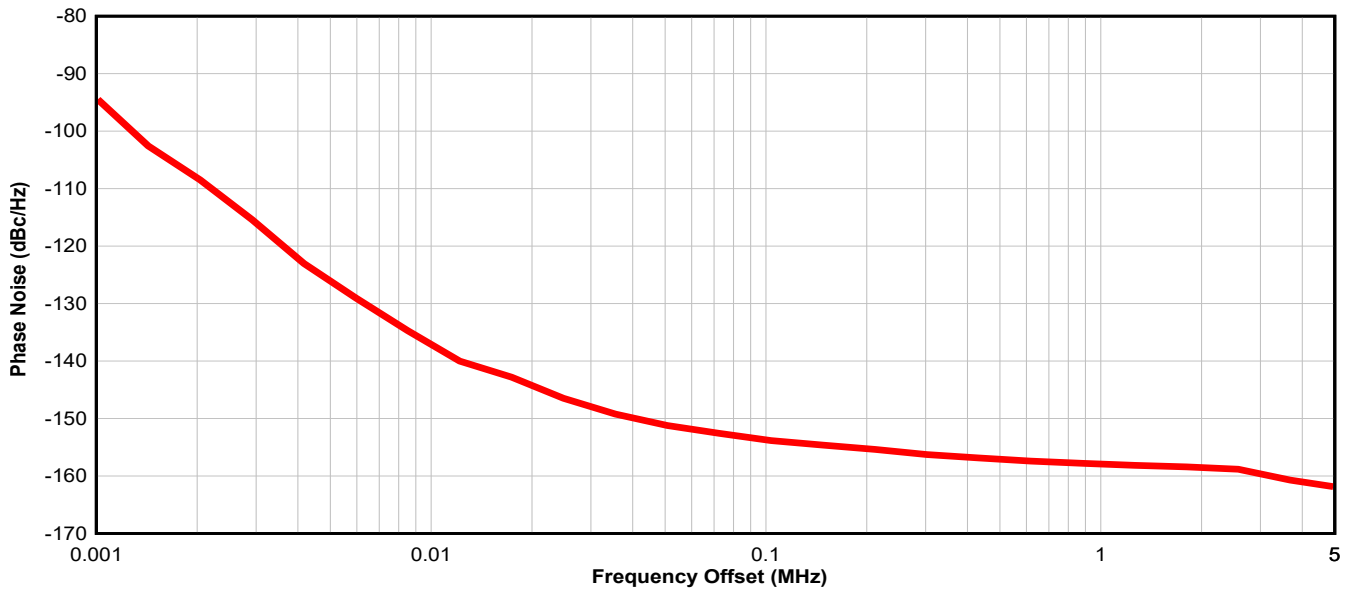

Figure 9-2. 19.2MHz LVC MOS, 25°C, 3.3V Supply

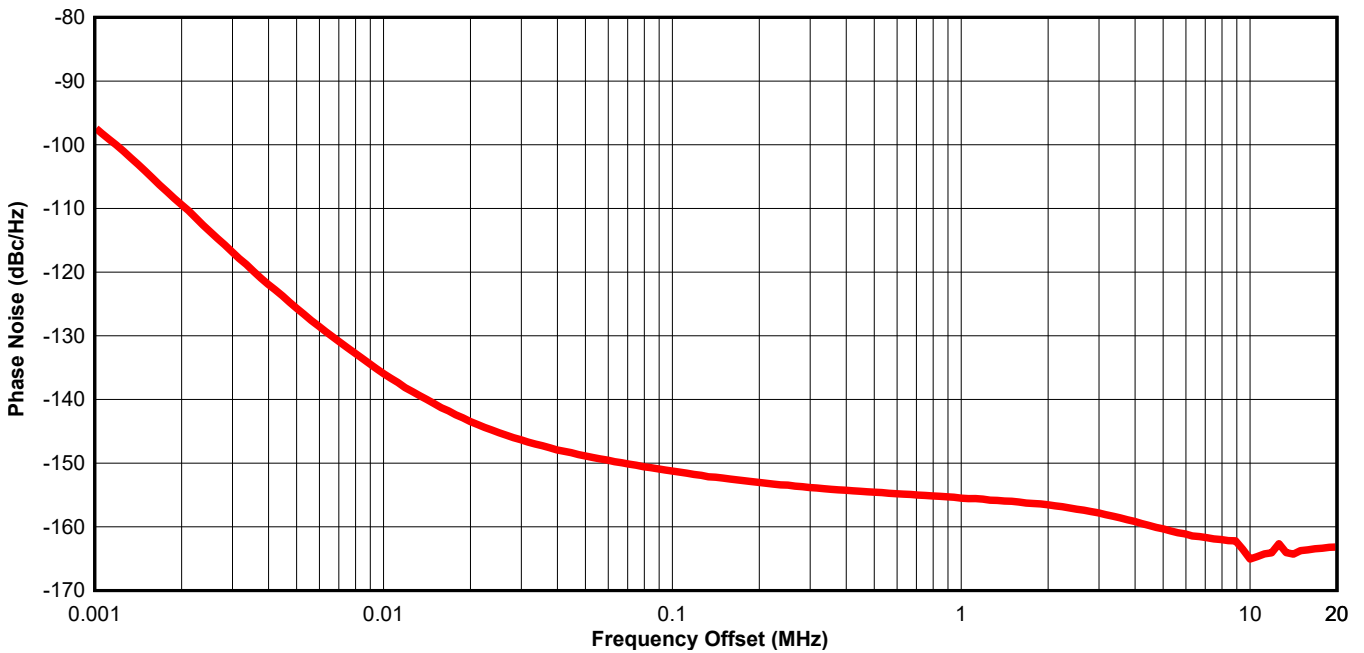

Figure 9-3. 25MHz LVC MOS, 25°C, 3.3V Supply

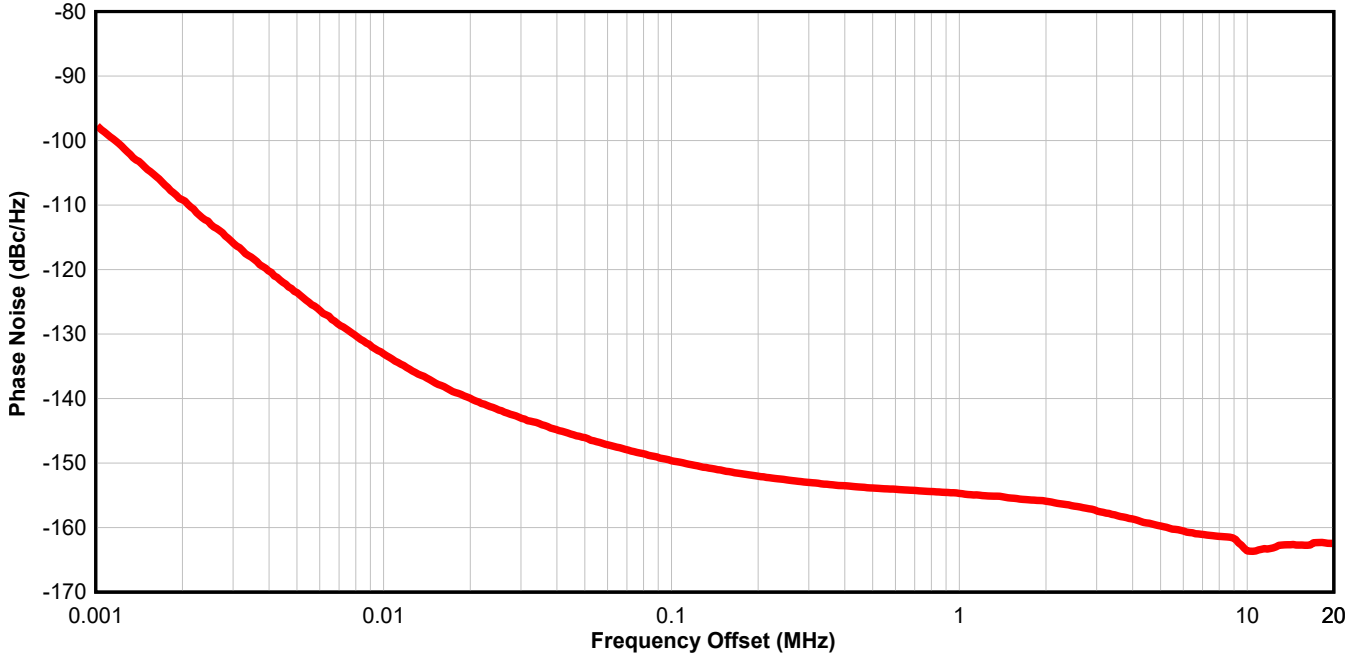

Figure 9-4. 27MHz LVC MOS, 25°C, 3.3V Supply

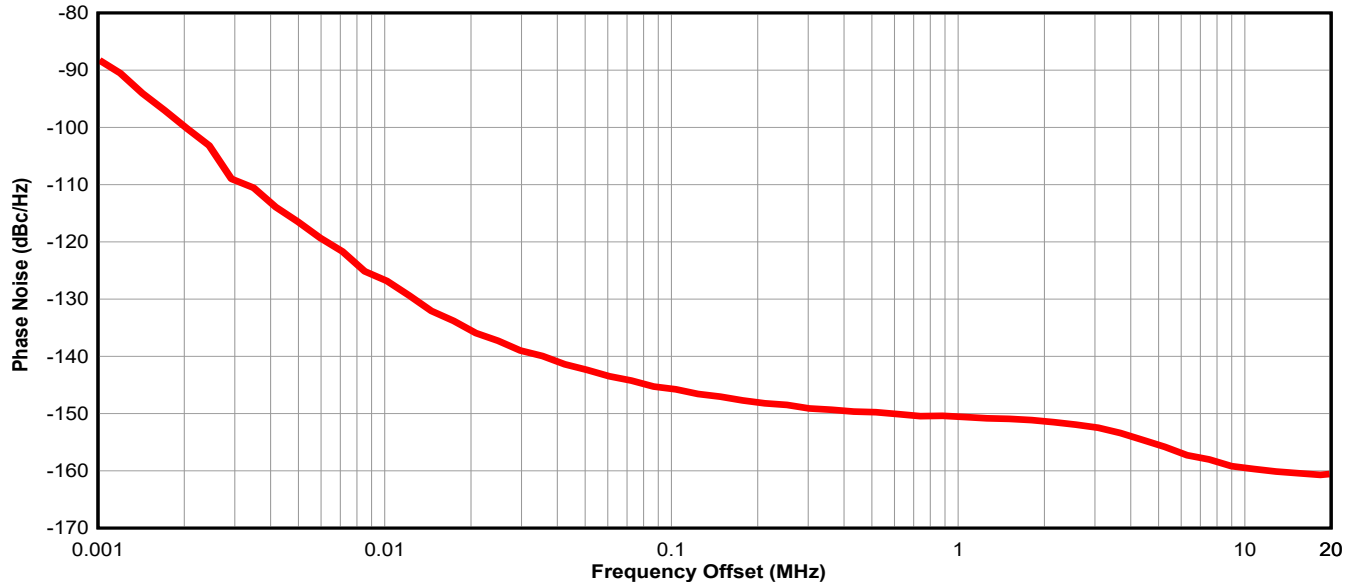

Figure 9-5. 50MHz LVC MOS, 25°C, 3.3V Supply

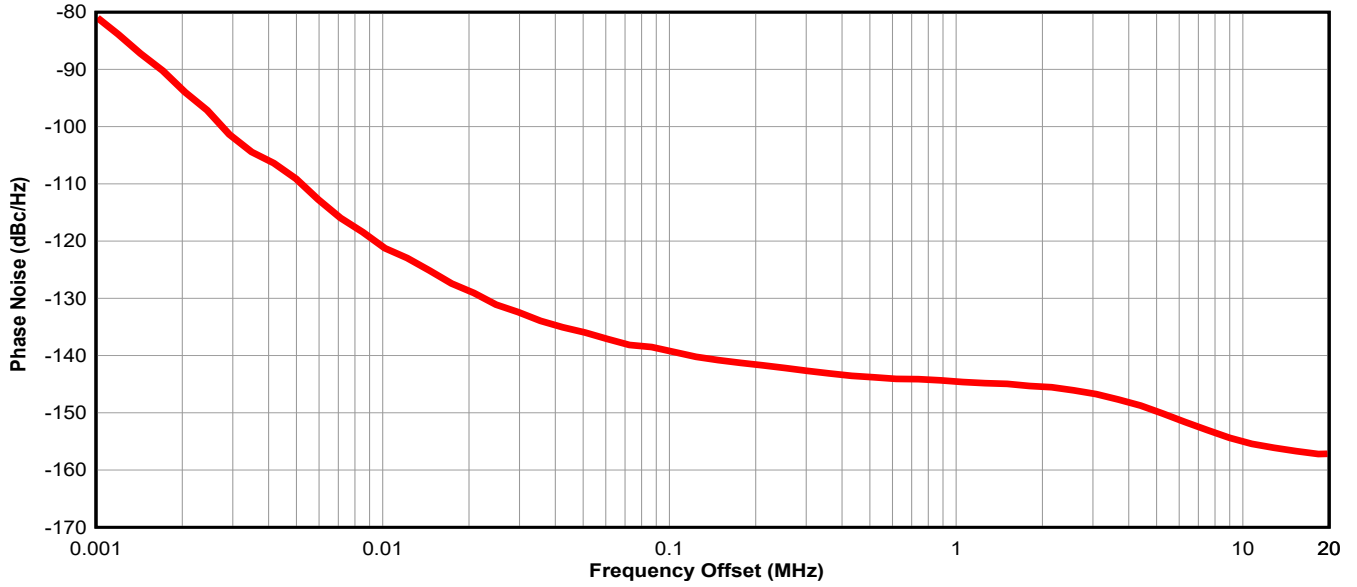

Figure 9-6. 100MHz LVCMOS, 25°C, 3.3V Supply

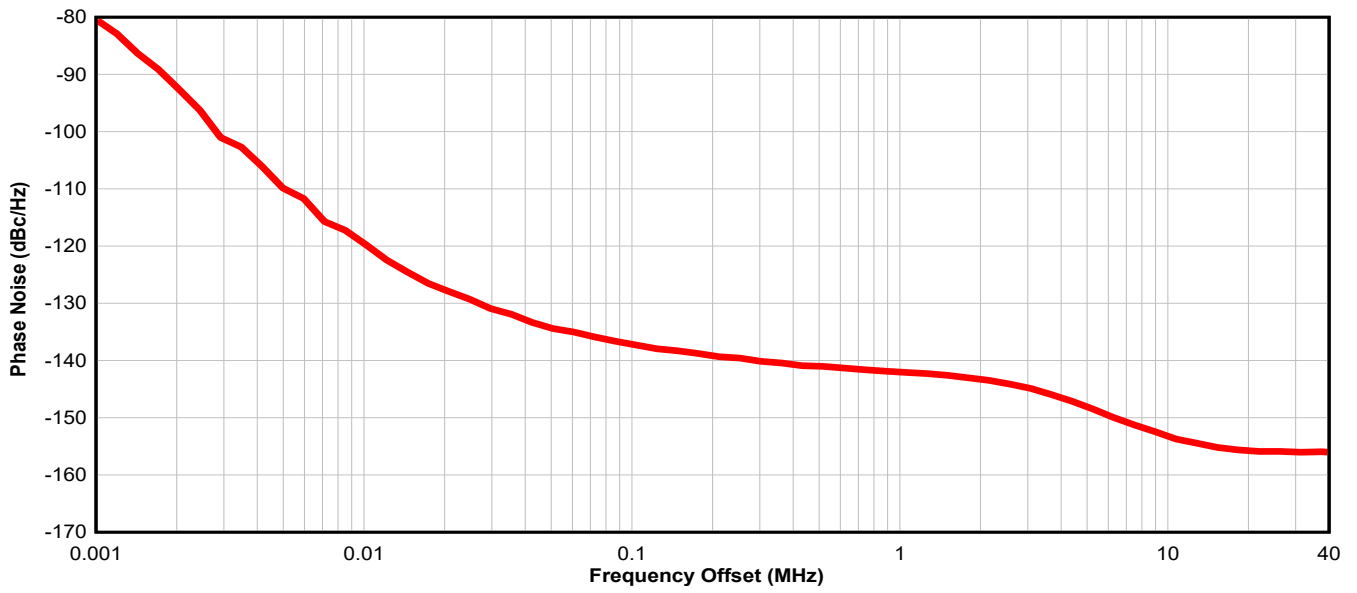

Figure 9-7. 125MHz LVCMOS, 25°C, 3.3V Supply

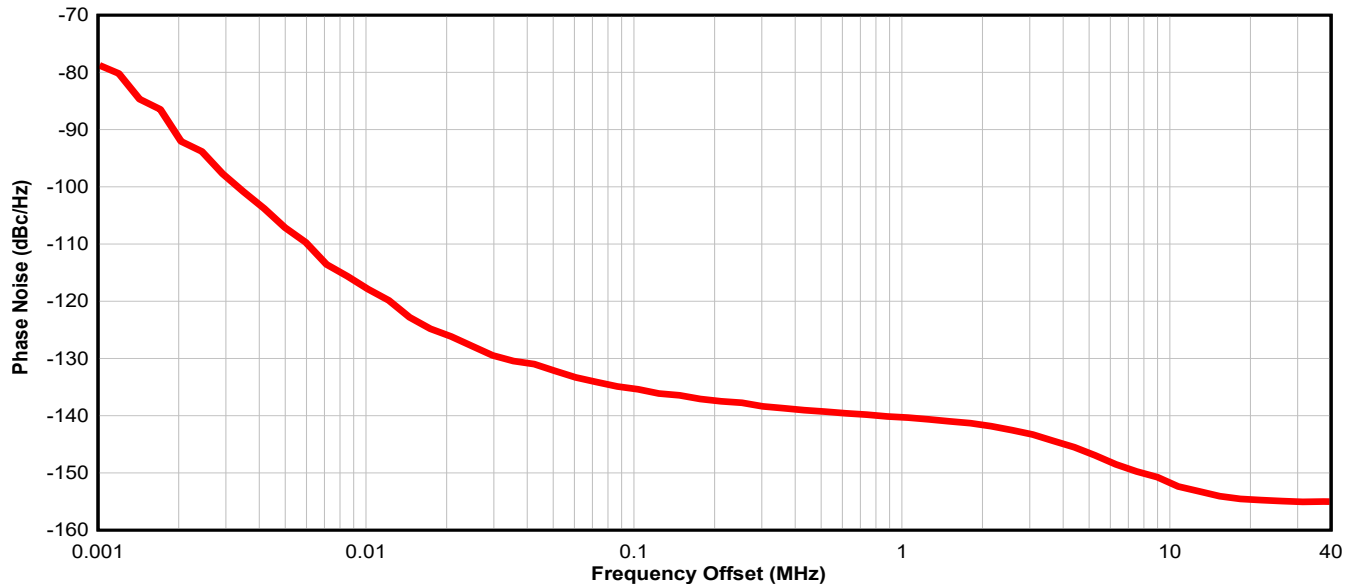

Figure 9-8. 156.25MHz LVCMOS, 25°C, 3.3V Supply

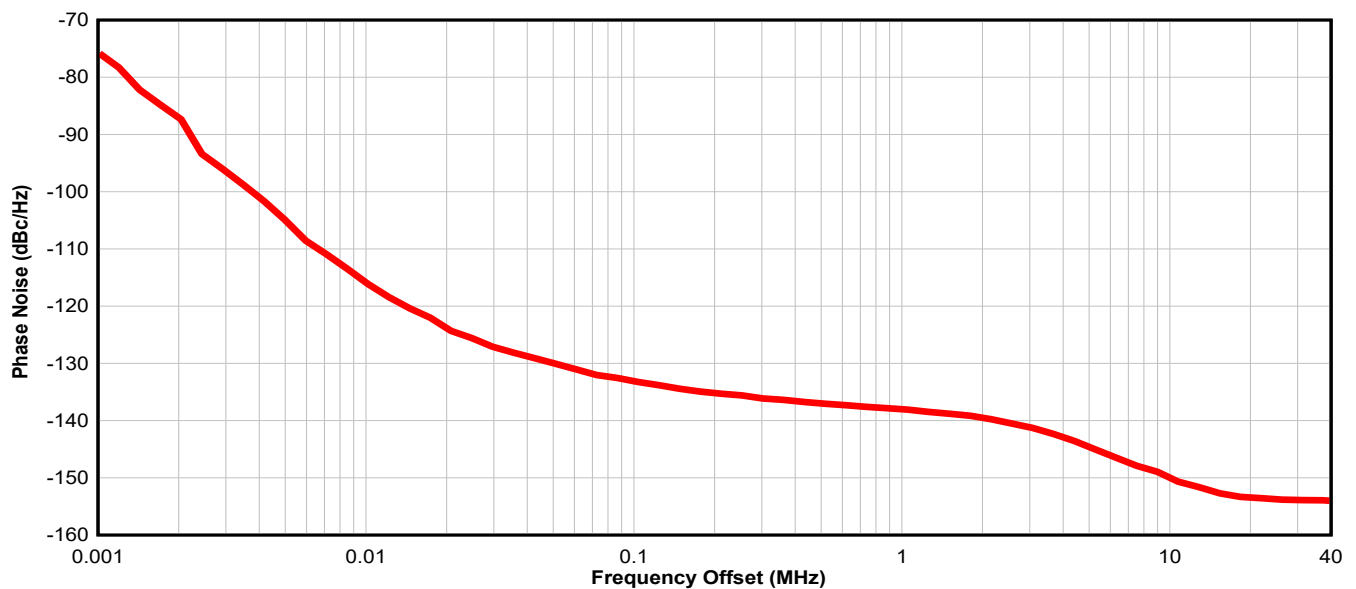

Figure 9-9. 200MHz LVCMOS, 25°C, 3.3V Supply

9.3 Power Supply Recommendations

For the best electrical performance of the CDC6Cx, TI recommends using a single 1μF power supply bypass capacitor. TI also recommends using component side mounting of the power supply bypass capacitors. 0201 or 0402 body size capacitors facilitate best signal routing. Keep the connections between the bypass capacitors and the power supply on the device as short as possible. Ground the other side of the capacitor using a low impedance connection to the ground plane.

V_{DD} power-up ramp time is defined as minimum time taken for power supply to exceed 95% of nominal V_{DD} . Monotonic power supply ramp is assumed. In case the power supply falls between 1V to 1.5V after the power supply already reached >1.5V, the output is muted after power supply ramps back to >1.5V. The output clock recovers, when V_{DD} is lowered below 1V and ramped back to >1.5V.

9.4 Layout

9.4.1 Layout Guidelines

The following sections provides recommendations for board layout, solder reflow profile and power-supply bypassing when using the CDC6Cx to provide good thermal and electrical performance and signal integrity of the entire system.

9.4.1.1 Providing Thermal Reliability

The CDC6Cx is a low power, high performance device. Therefore, pay careful attention to device configuration and printed circuit board (PCB) layout with respect to power consumption. The ground pin must be connected to the ground plane of the PCB through three vias or more to maximize thermal dissipation out of the package.

The equation below describes the relationship between the PCB temperature around the CDC6Cx and the junction temperature.

$$T_B = T_J - \Psi_{JB} \times P \quad (1)$$

where

- T_B : PCB temperature around the CDC6Cx
- T_J : Junction temperature of CDC6Cx
- Ψ_{JB} : Junction-to-board thermal resistance parameter of CDC6Cx (refer to the *Thermal Information* tables in the [Specifications](#) section for this information)
- P: On-chip power dissipation of CDC6Cx

9.4.1.2 Recommended Solder Reflow Profile

TI recommends following the recommendations from the solder paste supplier to optimize flux activity and to achieve proper melting temperatures of the alloy within the guidelines of J-STD-020E. Processing the CDC6Cx with the lowest peak temperature possible while also remaining below the components peak temperature rating as listed on the MSL label is preferable. The exact temperature profile depends on several factors including maximum peak temperature for the component as rated on the MSL label, Board thickness, PCB material type, PCB geometries, component locations, sizes, densities within PCB, solder manufactures recommended profile, and capability of the reflow equipment as confirmed by the SMT assembly operation.

9.4.2 Layout Examples

Figure 9-10 shows the printed circuit board (PCB) layout examples as done on the evaluation module (EVM) for the CDC6Cx.

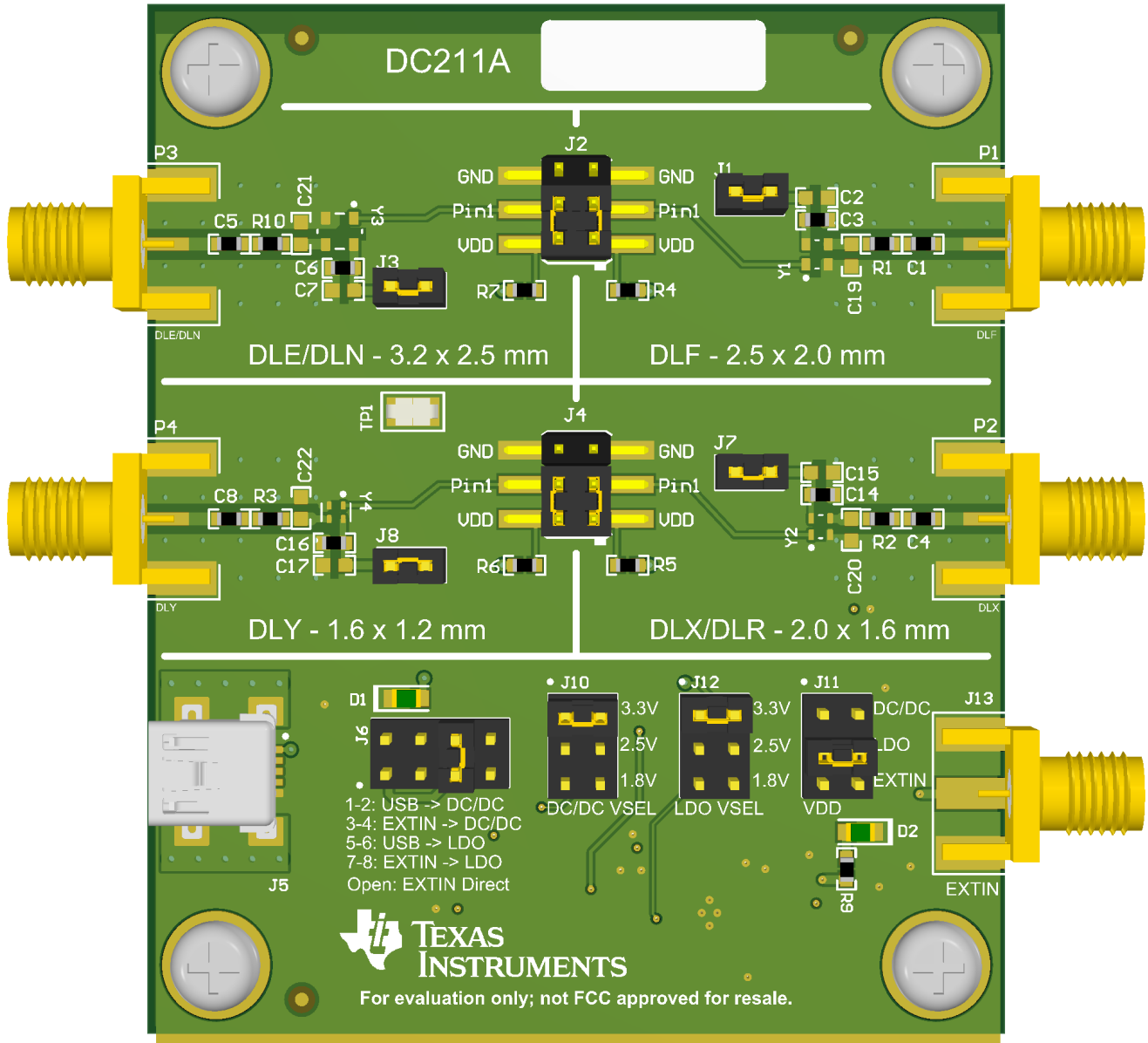

Figure 9-10. PCB Layout Example From CDC6 EVM

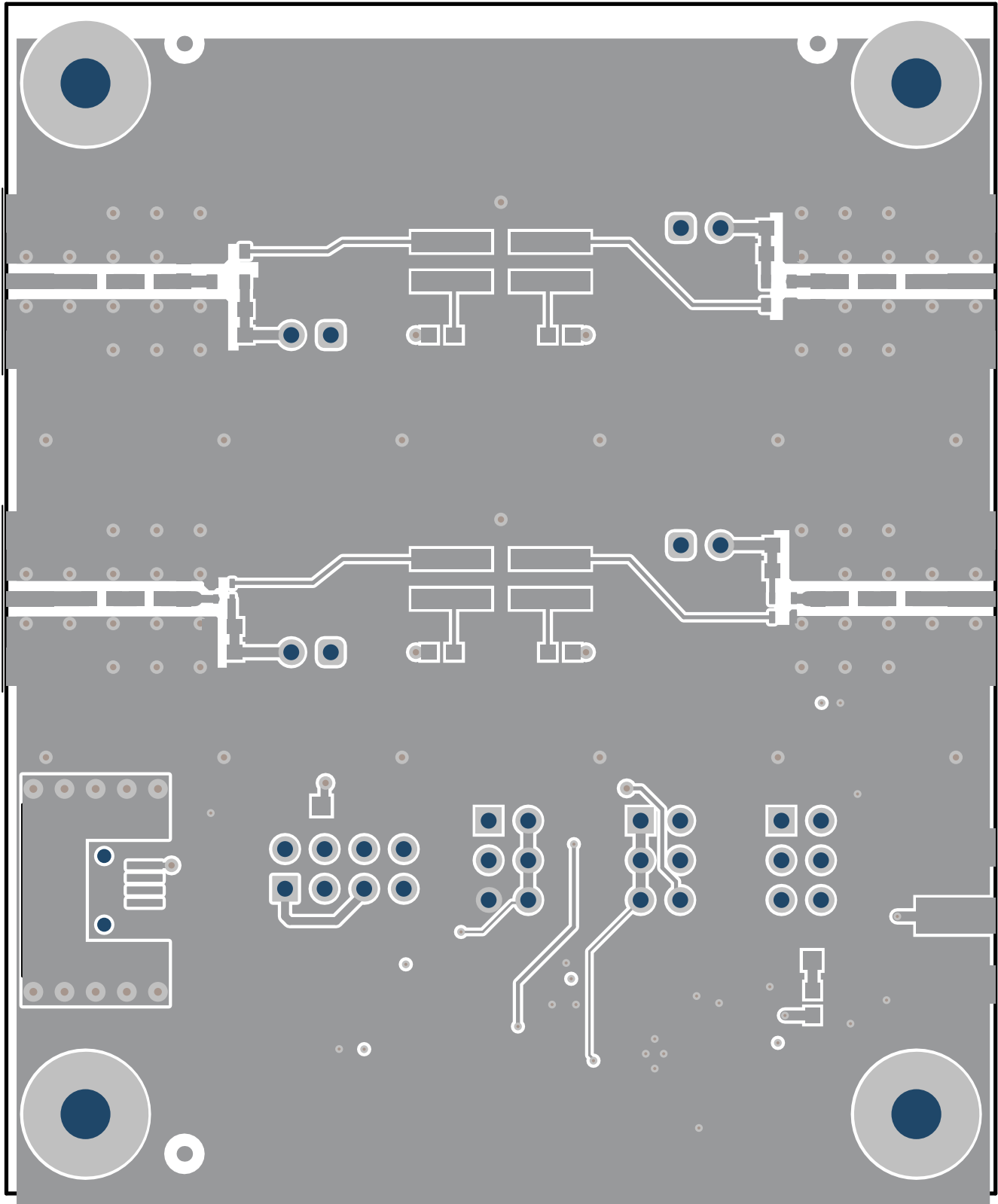

Figure 9-11. PCB Layout Example From CDC6 EVM - Top Layer

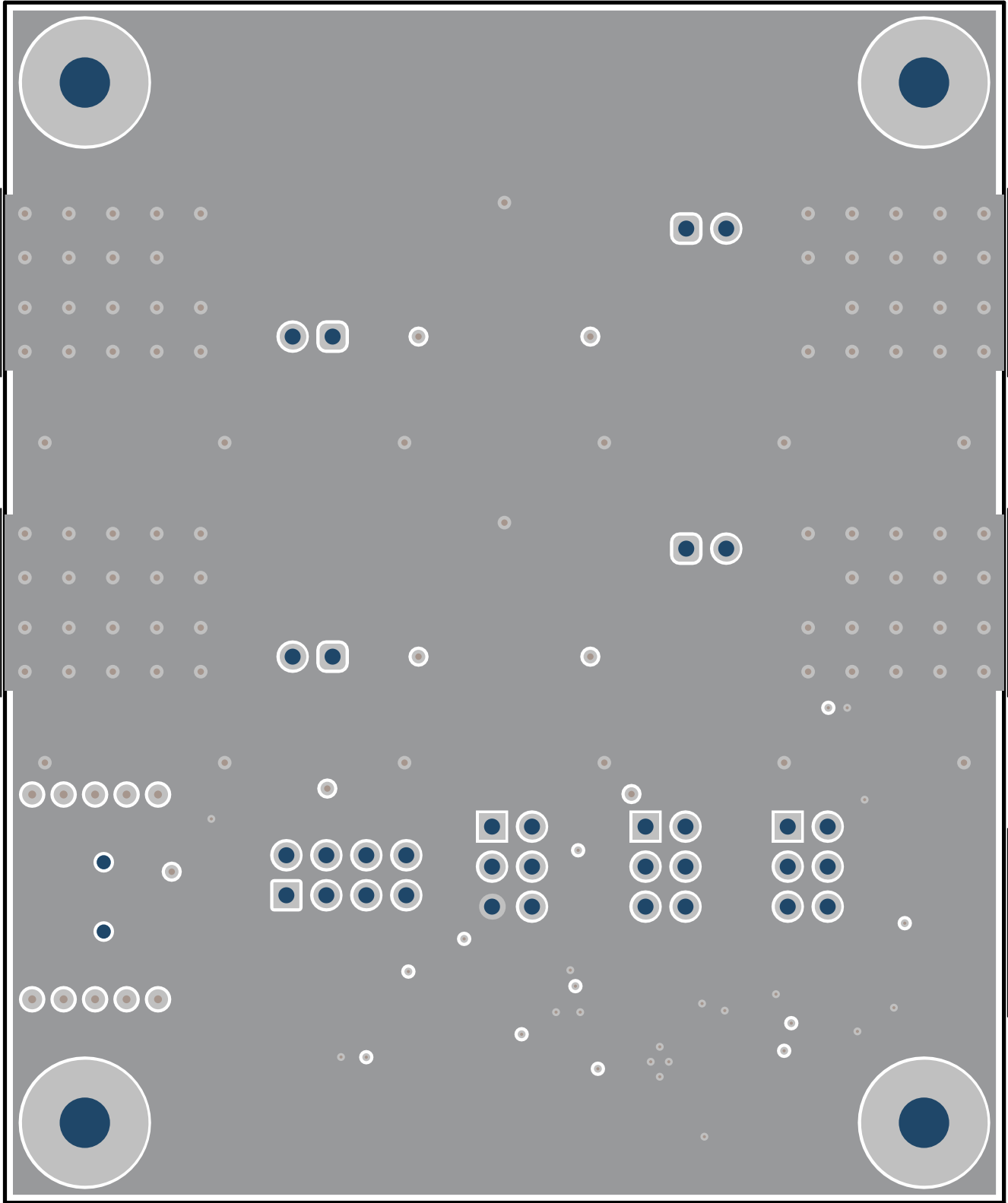

Figure 9-12. PCB Layout Example From CDC6 EVM - GND Layer

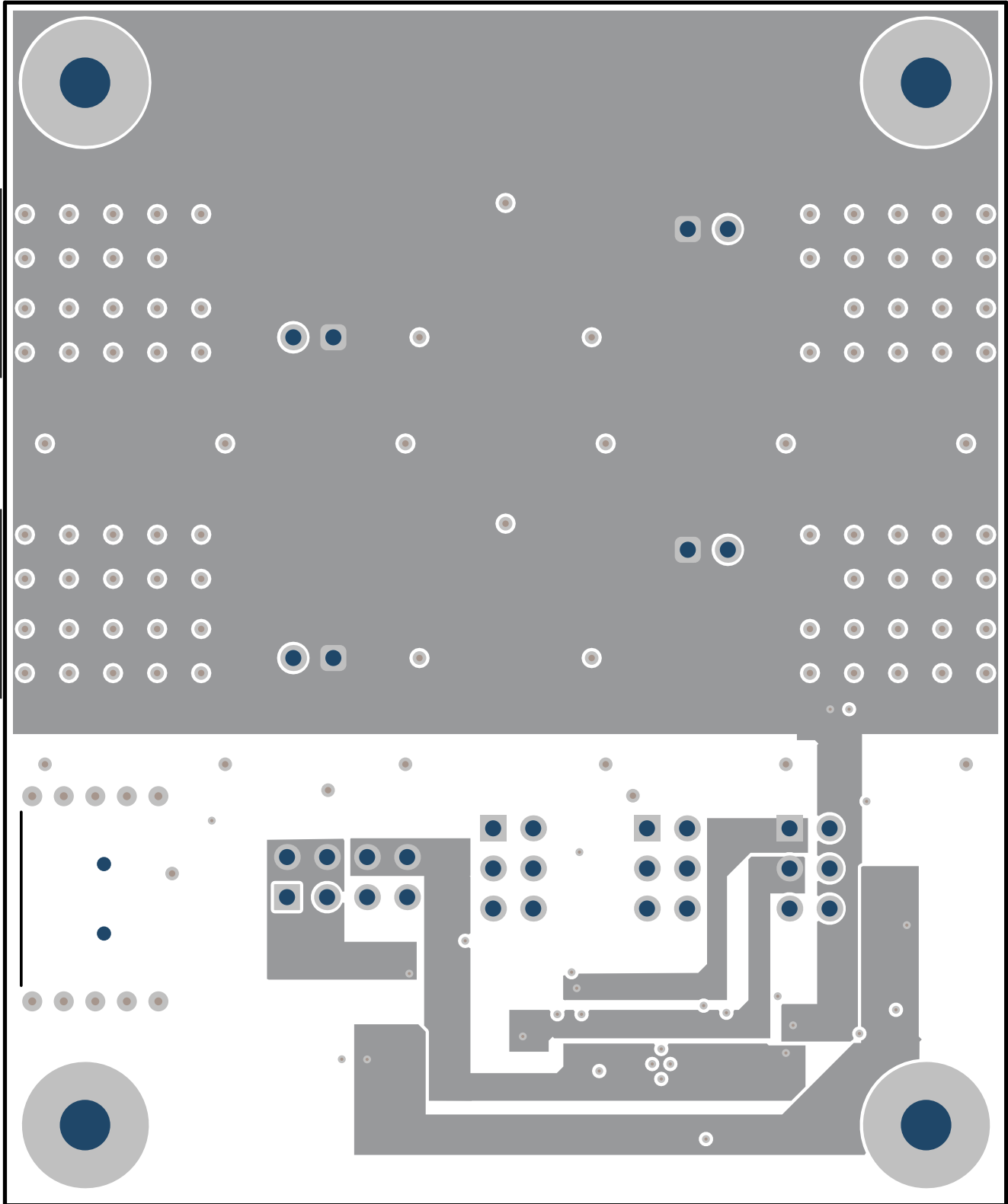

Figure 9-13. PCB Layout Example From CDC6 EVM - Power Layer

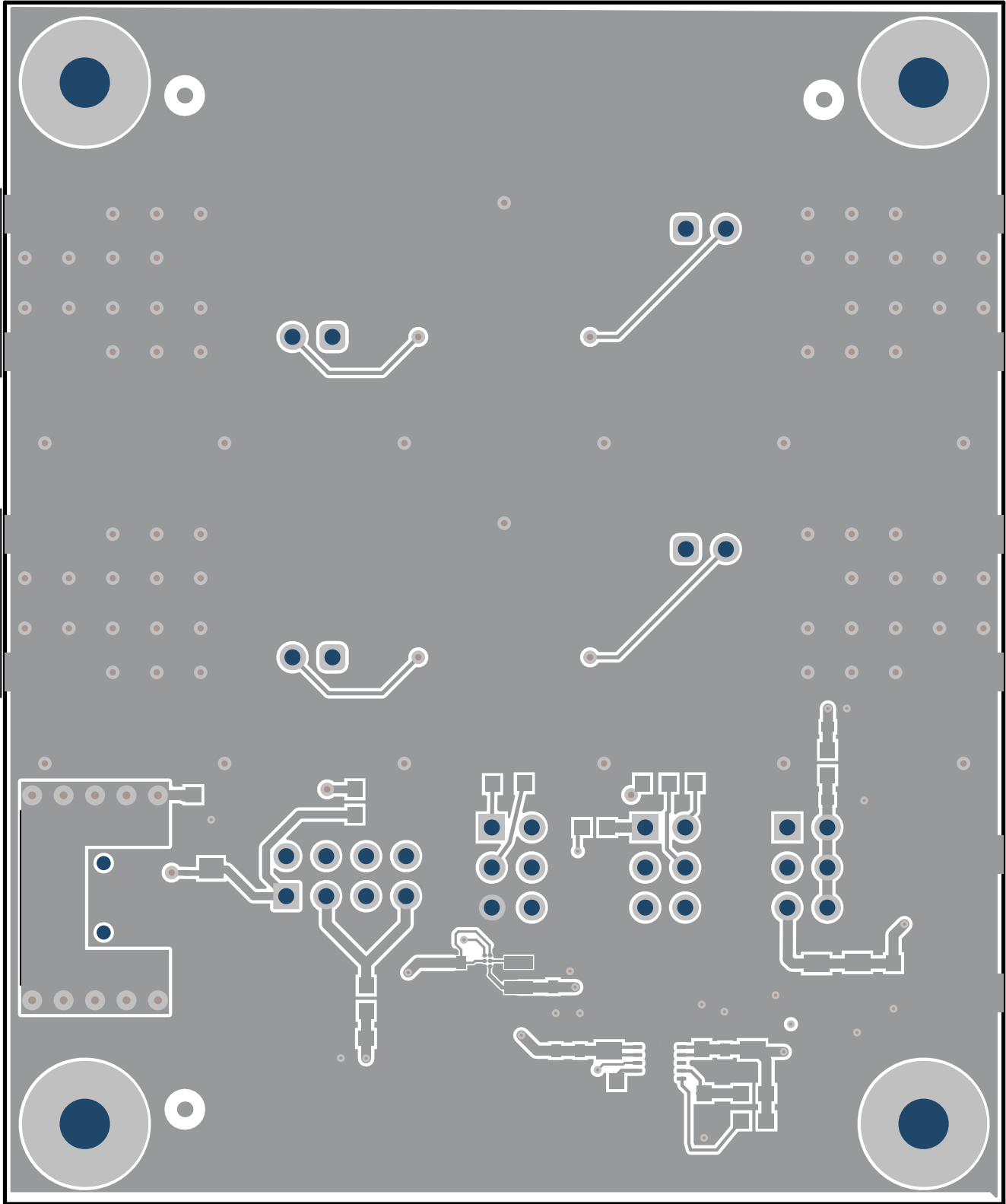

Figure 9-14. PCB Layout Example From CDC6 EVM - Bottom Layer

10 Device and Documentation Support

TI offers an extensive line of development tools. Tools and software to evaluate the performance of the device, generate code, and develop designs are listed below.

10.1 Documentation Support

10.1.1 Related Documentation

For related documentation, see the following:

- Texas Instruments, [CDC6CEVM User's Guide](#)
- Texas Instruments, [CDC6C OPN Decoder application note](#)
- Texas Instruments, [CDC6C-Q1 Functional Safety FIT Rate, FMD and Pin FMA](#)
- Texas Instruments, [Standalone BAW Oscillators Advantages Over Quartz Oscillators application note](#)
- Texas Instruments, [Driving Multiple Loads With a Single LVCMOS Oscillator application note](#)
- Texas Instruments, [CDC6Cx-Q1 CISPR25 Radiated Emission Performance Report](#)
- Texas Instruments, [BAW Oscillator Designs for Building Automation application note](#)
- Texas Instruments, [BAW Oscillator Designs for Factory Automation application note](#)
- Texas Instruments, [BAW Oscillator Designs for Grid Infrastructure application note](#)
- Texas Instruments, [BAW Oscillator Designs for Optical Modules application note](#)

10.2 Receiving Notification of Documentation Updates

To receive notification of documentation updates, navigate to the device product folder on [ti.com](https://www.ti.com). Click on *Notifications* to register and receive a weekly digest of any product information that has changed. For change details, review the revision history included in any revised document.

10.3 Support Resources

[TI E2E™ support forums](#) are an engineer's go-to source for fast, verified answers and design help — straight from the experts. Search existing answers or ask your own question to get the quick design help you need.

Linked content is provided "AS IS" by the respective contributors. They do not constitute TI specifications and do not necessarily reflect TI's views; see TI's [Terms of Use](#).

10.4 Trademarks

TI E2E™ is a trademark of Texas Instruments.

All trademarks are the property of their respective owners.

10.5 Electrostatic Discharge Caution



This integrated circuit can be damaged by ESD. Texas Instruments recommends that all integrated circuits be handled with appropriate precautions. Failure to observe proper handling and installation procedures can cause damage.

ESD damage can range from subtle performance degradation to complete device failure. Precision integrated circuits may be more susceptible to damage because very small parametric changes could cause the device not to meet its published specifications.

10.6 Glossary

[TI Glossary](#) This glossary lists and explains terms, acronyms, and definitions.

11 Revision History

NOTE: Page numbers for previous revisions may differ from page numbers in the current version.

Changes from Revision B (May 2025) to Revision C (July 2025)	Page
• Specified frequency stability for each package size.....	1
• Specified available frequency stability orderable options per package size.....	1
• Improve frequency stability (to ± 25 ppm) for DLE, DLF, and DLX packages.....	6
• Specified improved frequency stability for DLE, DLF, and DLX packages.....	13

Changes from Revision A (January 2025) to Revision B (May 2025)	Page
• Updated the numbering formatting for tables, figures, and cross-references throughout the document.....	1
• Added legend to explain color assignment for Table 5-1	4
• Added output frequency used for all output rise and fall time data.....	6
• Added frequency stability for -40°C to 85°C temperature range.....	6
• Combined random phase jitter to show jitter values based on output frequency range rather than specific output frequencies.....	6
• Changed 25MHz output to include random phase jitter from 12kHz to 20MHz offsets.....	6
• Removed integration bandwidth for RMS period jitter.....	6
• Updated Figure 6-9 to include frequency offsets through 20MHz.....	9
• Updated the <i>Detailed Design Procedure</i> to specify output frequency of 25MHz and corrected rise and fall times to match the <i>Electrical Characteristics</i> table.....	19
• Changed Figure 9-3 and Figure 9-4 to include frequency offsets through 20MHz.....	20
• Updated the <i>Mechanical, Packaging, and Orderable Information</i> section.....	32

Changes from Revision * (December 2024) to Revision A (January 2025)	Page
• Updated the numbering formatting for tables, figures, and cross-references throughout the document.....	1

12 Mechanical, Packaging, and Orderable Information

The following pages include mechanical, packaging, and orderable information. This information is the most current data available for the designated devices. This data is subject to change without notice and revision of this document. For browser-based versions of this data sheet, refer to the left-hand navigation.



DLY0004C

PACKAGE OUTLINE

VSON - 1 mm max height

PLASTIC SMALL OUTLINE - NO LEAD

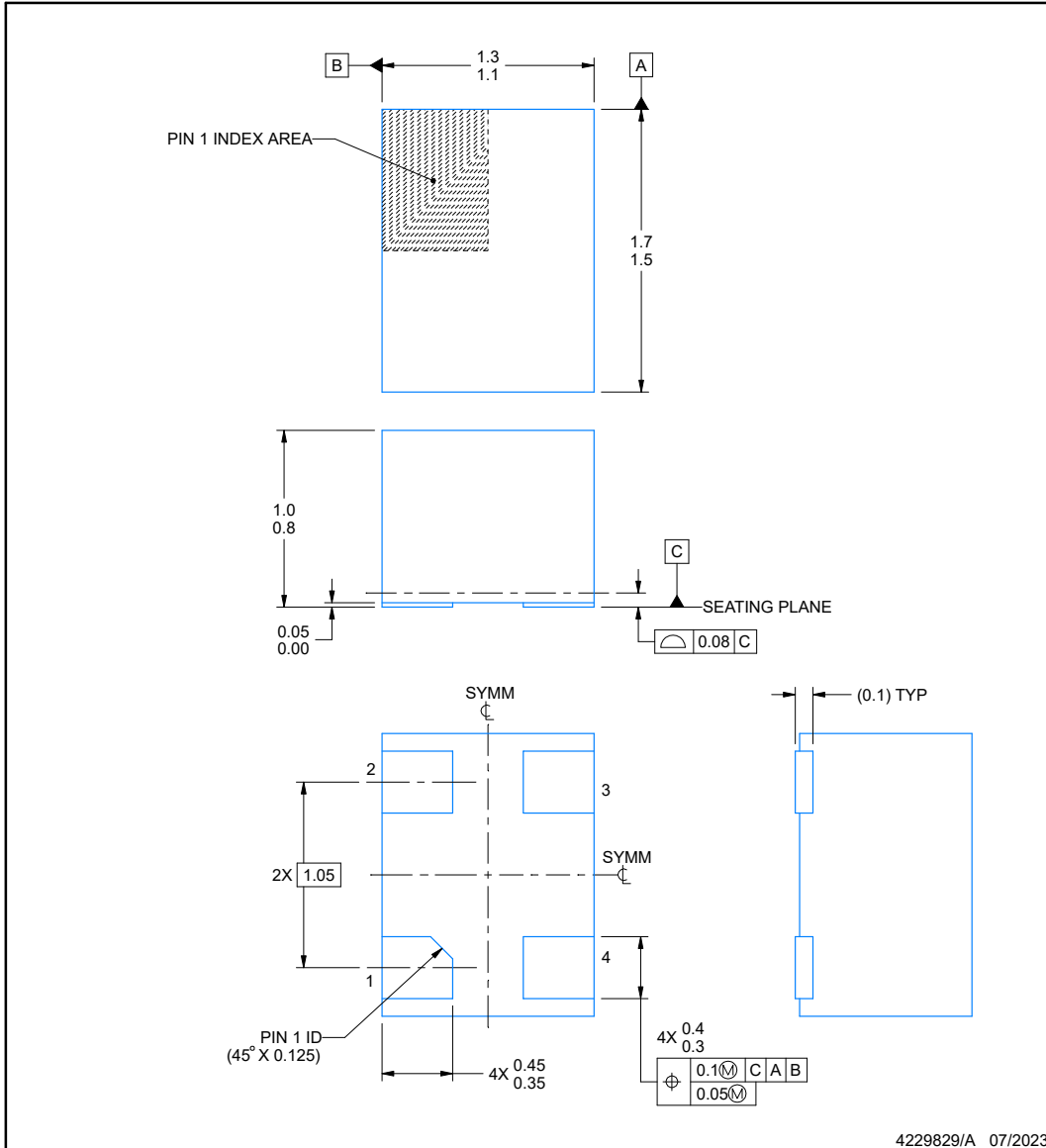

NOTES:

1. All linear dimensions are in millimeters. Any dimensions in parenthesis are for reference only. Dimensioning and tolerancing per ASME Y14.5M.
2. This drawing is subject to change without notice.

EXAMPLE BOARD LAYOUT

DLY0004C

VSON - 1 mm max height

PLASTIC SMALL OUTLINE - NO LEAD

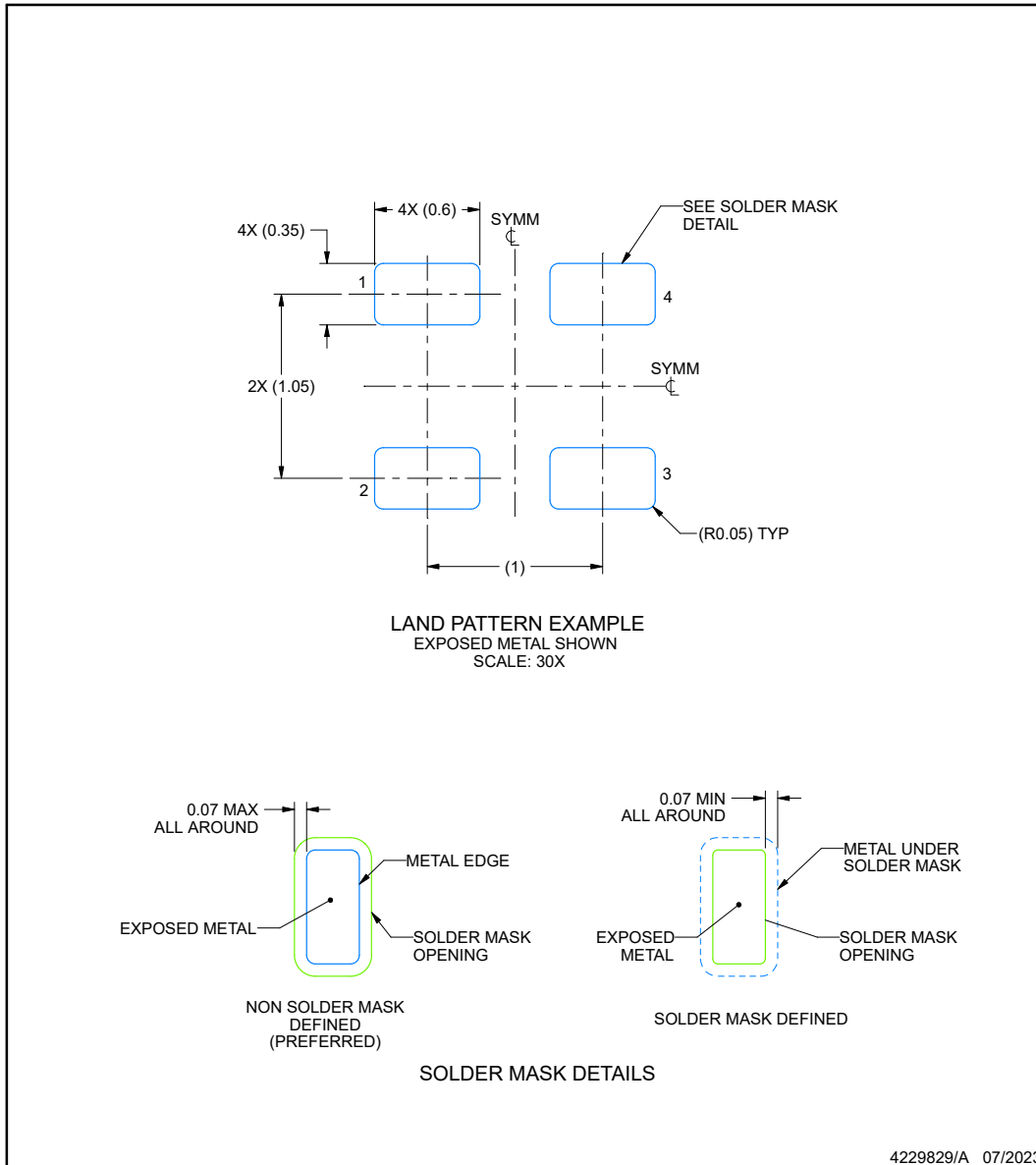

NOTES: (continued)

4. For more information, see Texas Instruments literature number SLUA271 (www.ti.com/lit/slua271).

EXAMPLE STENCIL DESIGN

DLY0004C

VSON - 1 mm max height

PLASTIC SMALL OUTLINE - NO LEAD

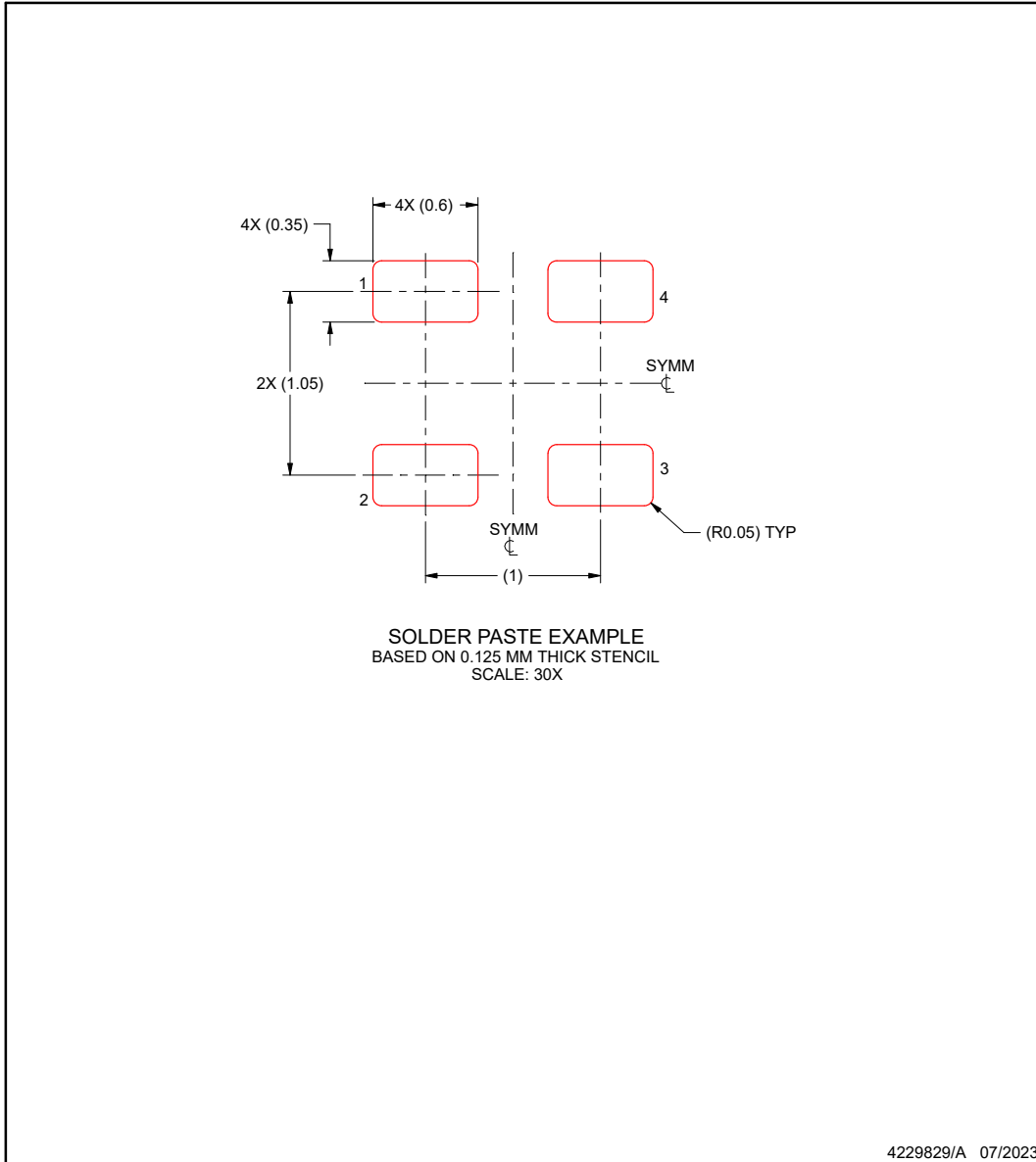

NOTES: (continued)

6. Laser cutting apertures with trapezoidal walls and rounded corners may offer better paste release. IPC-7525 may have alternate design recommendations.

PACKAGE OUTLINE

VSON - 1 mm max height

DLF0004A

PLASTIC QUAD FLAT PACK-NO LEAD

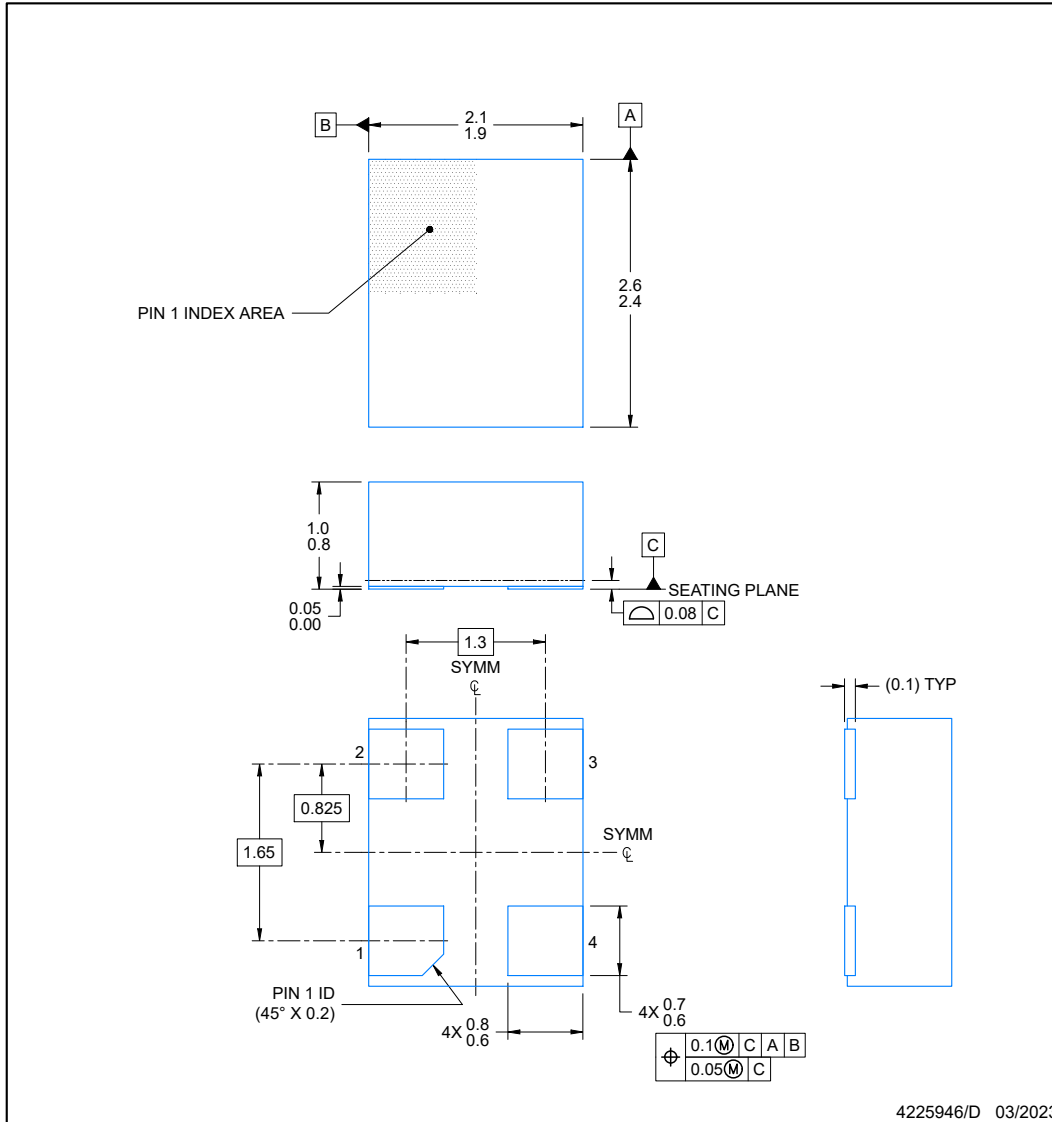

NOTES:

1. All linear dimensions are in millimeters. Any dimensions in parenthesis are for reference only. Dimensioning and tolerancing per ASME Y14.5M.
2. This drawing is subject to change without notice.

EXAMPLE BOARD LAYOUT

DLF0004A

VSON - 1 mm max height

PLASTIC QUAD FLAT PACK-NO LEAD

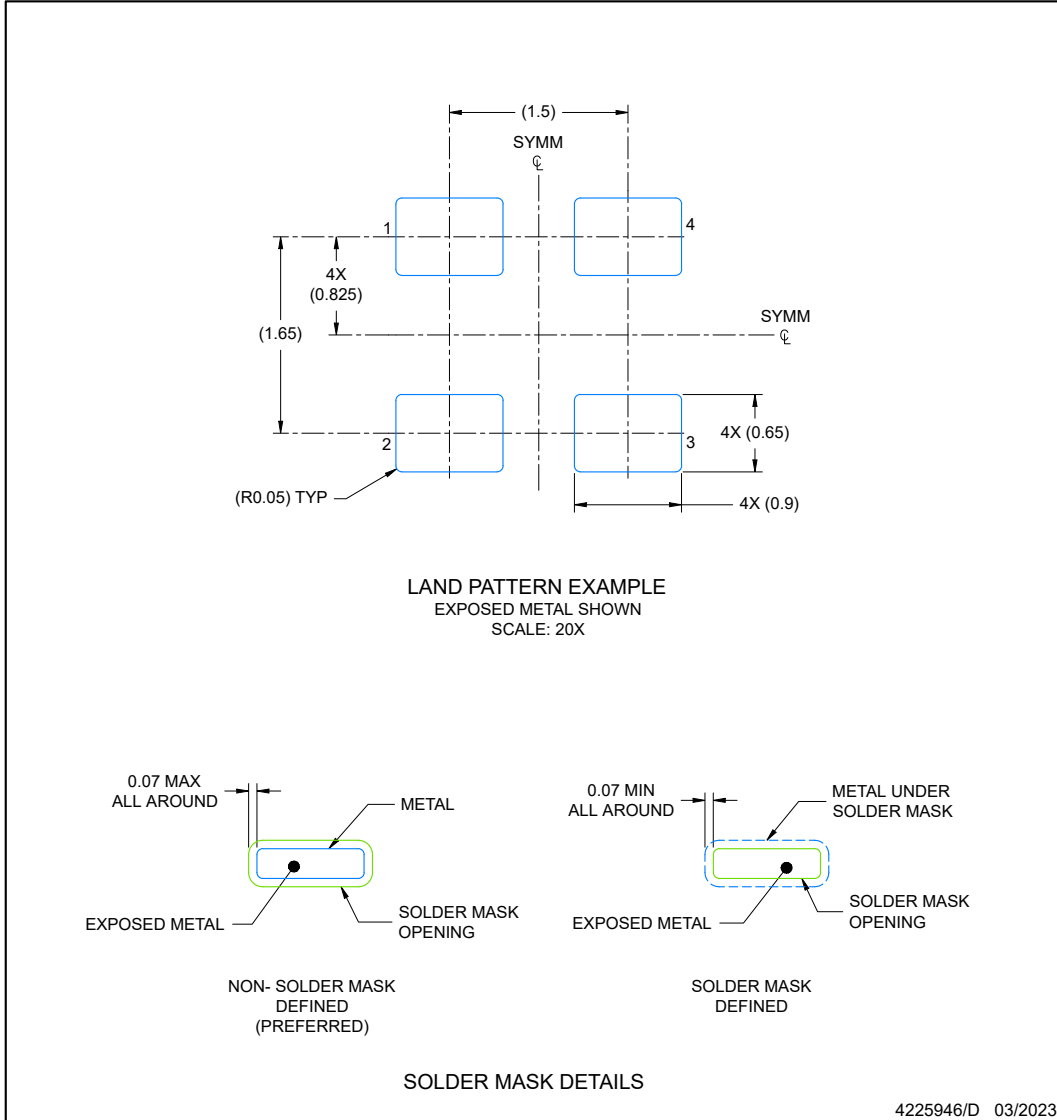

NOTES: (continued)

- For more information, see Texas Instruments literature number SLUA271 (www.ti.com/lit/sluea271).

EXAMPLE STENCIL DESIGN

DLF0004A

VSON - 1 mm max height

PLASTIC QUAD FLAT PACK-NO LEAD

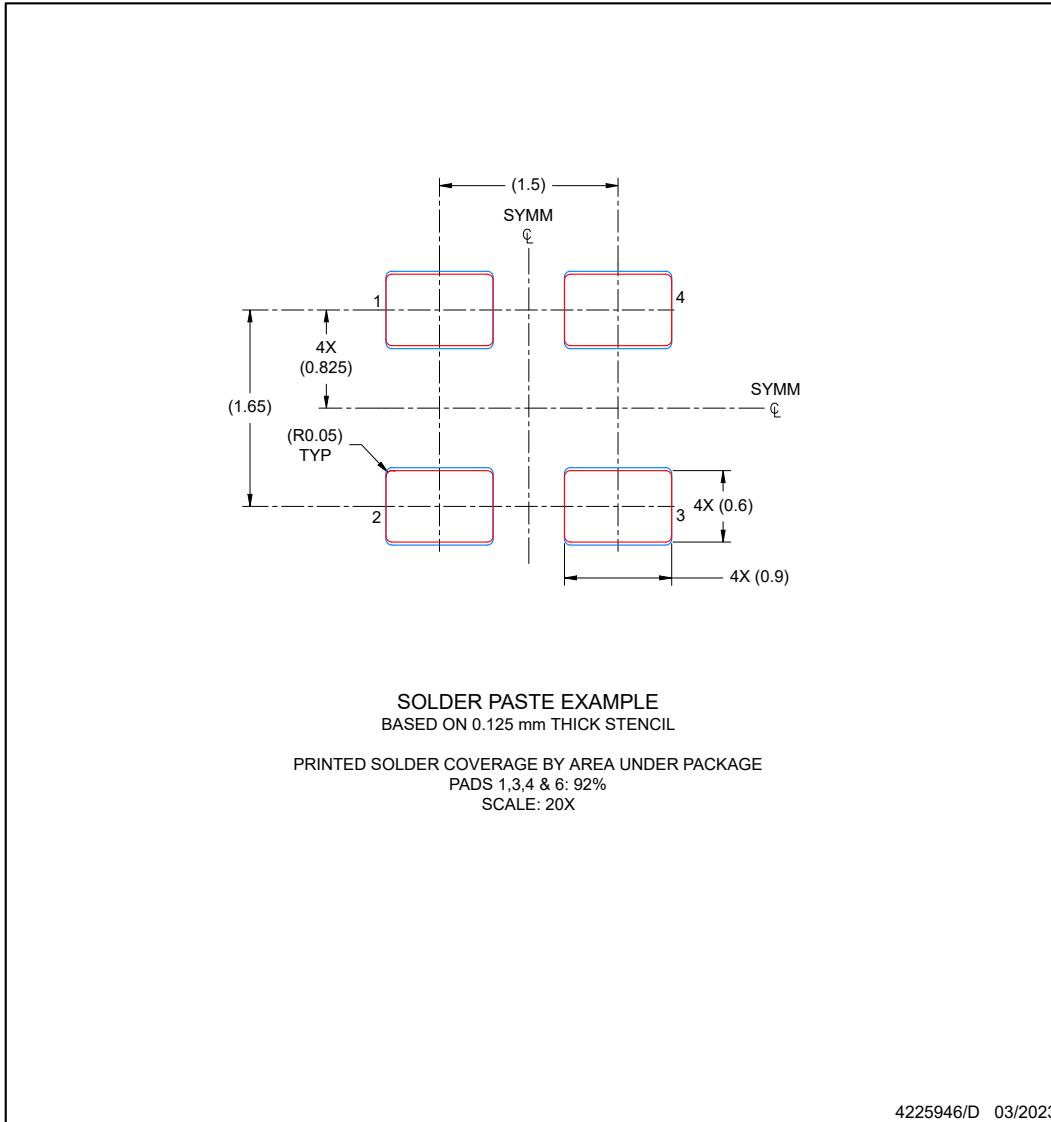

NOTES: (continued)

- 4. Laser cutting apertures with trapezoidal walls and rounded corners may offer better paste release. IPC-7525 may have alternate design recommendations.

DLE0004A

PACKAGE OUTLINE
VSON - 1 mm max height

PLASTIC QUAD FLAT PACK-NO LEAD

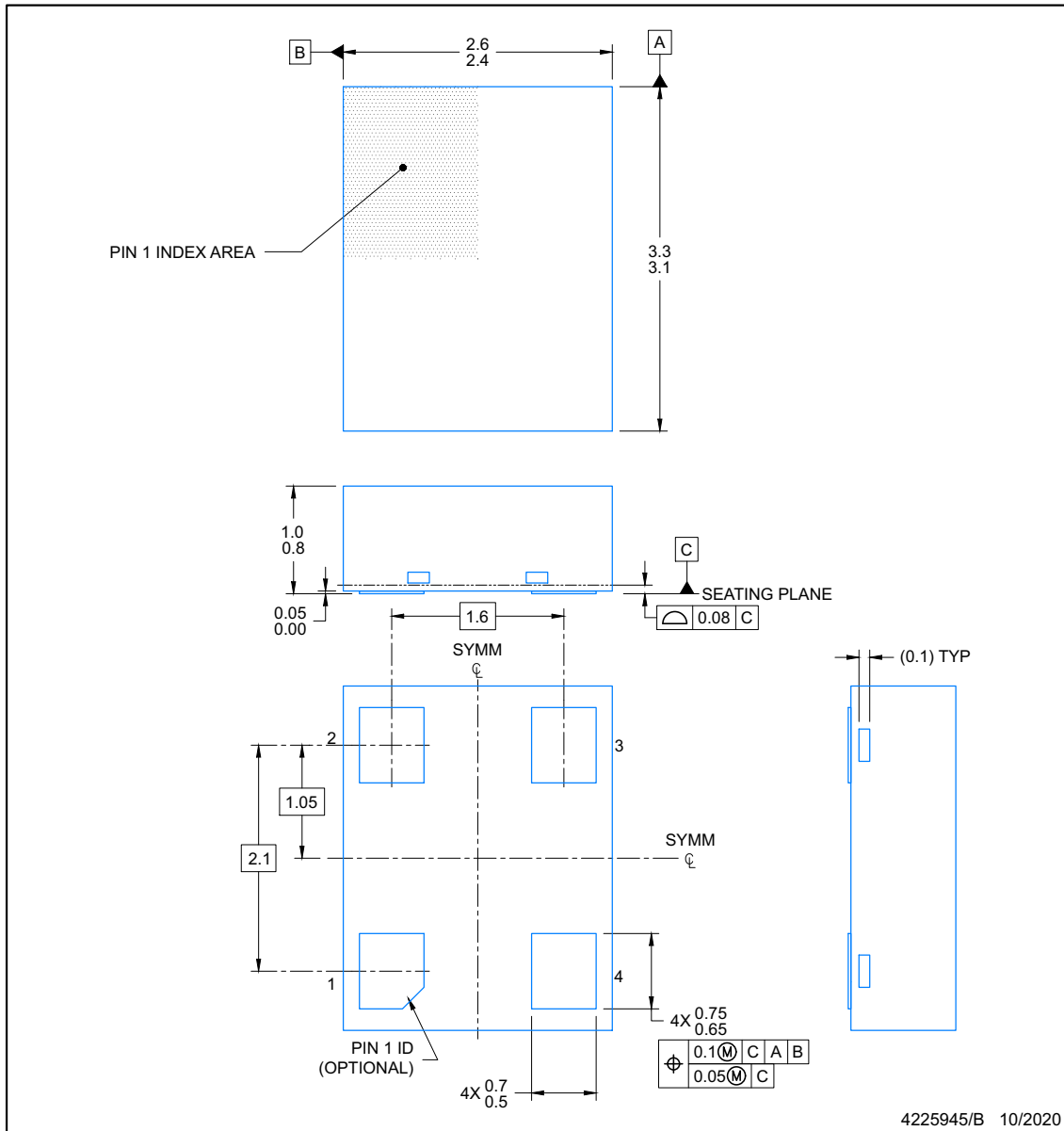

NOTES:

1. All linear dimensions are in millimeters. Any dimensions in parenthesis are for reference only. Dimensioning and tolerancing per ASME Y14.5M.
2. This drawing is subject to change without notice.

EXAMPLE BOARD LAYOUT

VSON - 1 mm max height

DLE0004A

PLASTIC QUAD FLAT PACK-NO LEAD

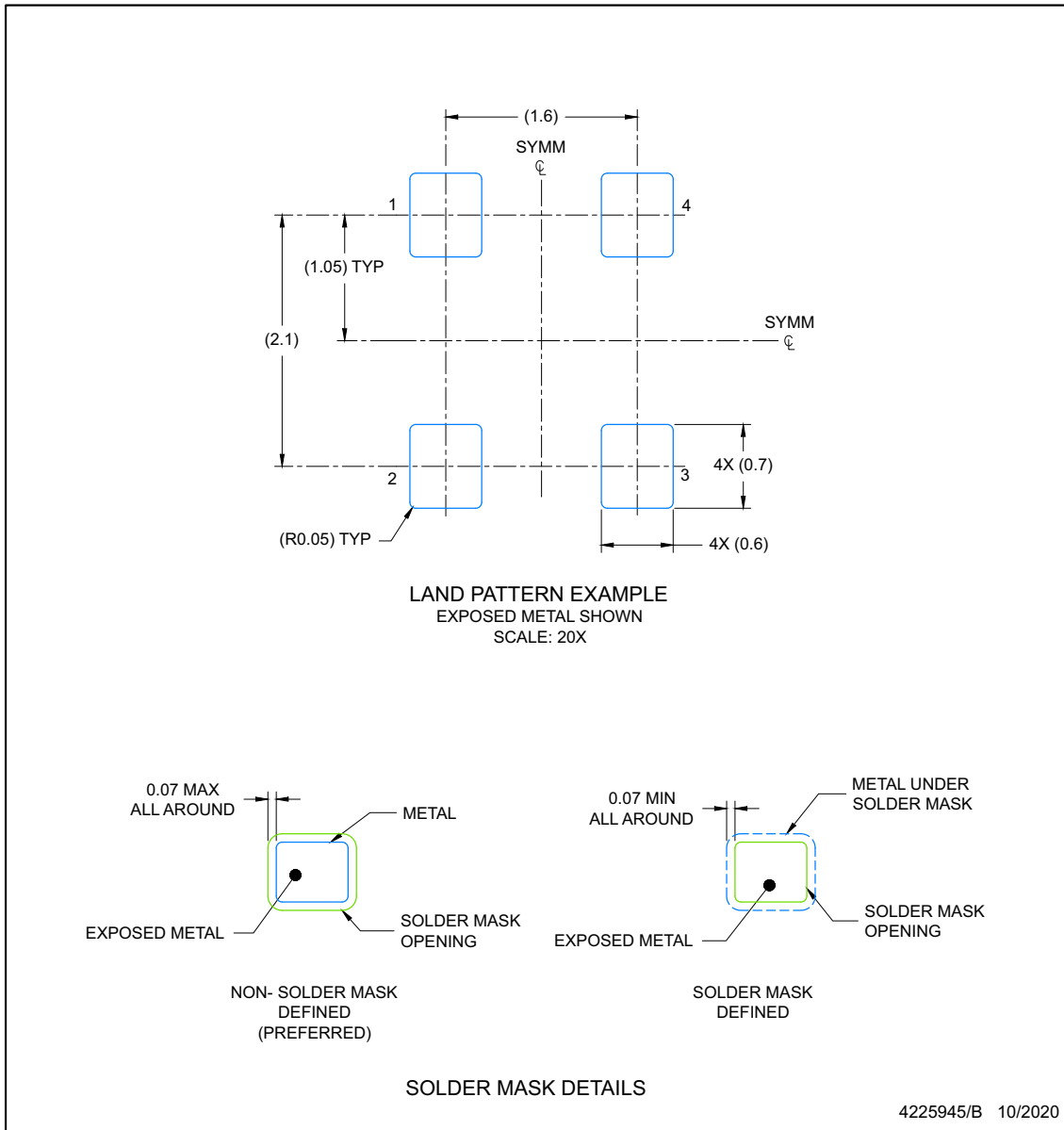

NOTES: (continued)

- For more information, see Texas Instruments literature number SLUA271 (www.ti.com/lit/sluea271) .

EXAMPLE STENCIL DESIGN
VSON - 1 mm max height

DLE0004A

PLASTIC QUAD FLAT PACK-NO LEAD

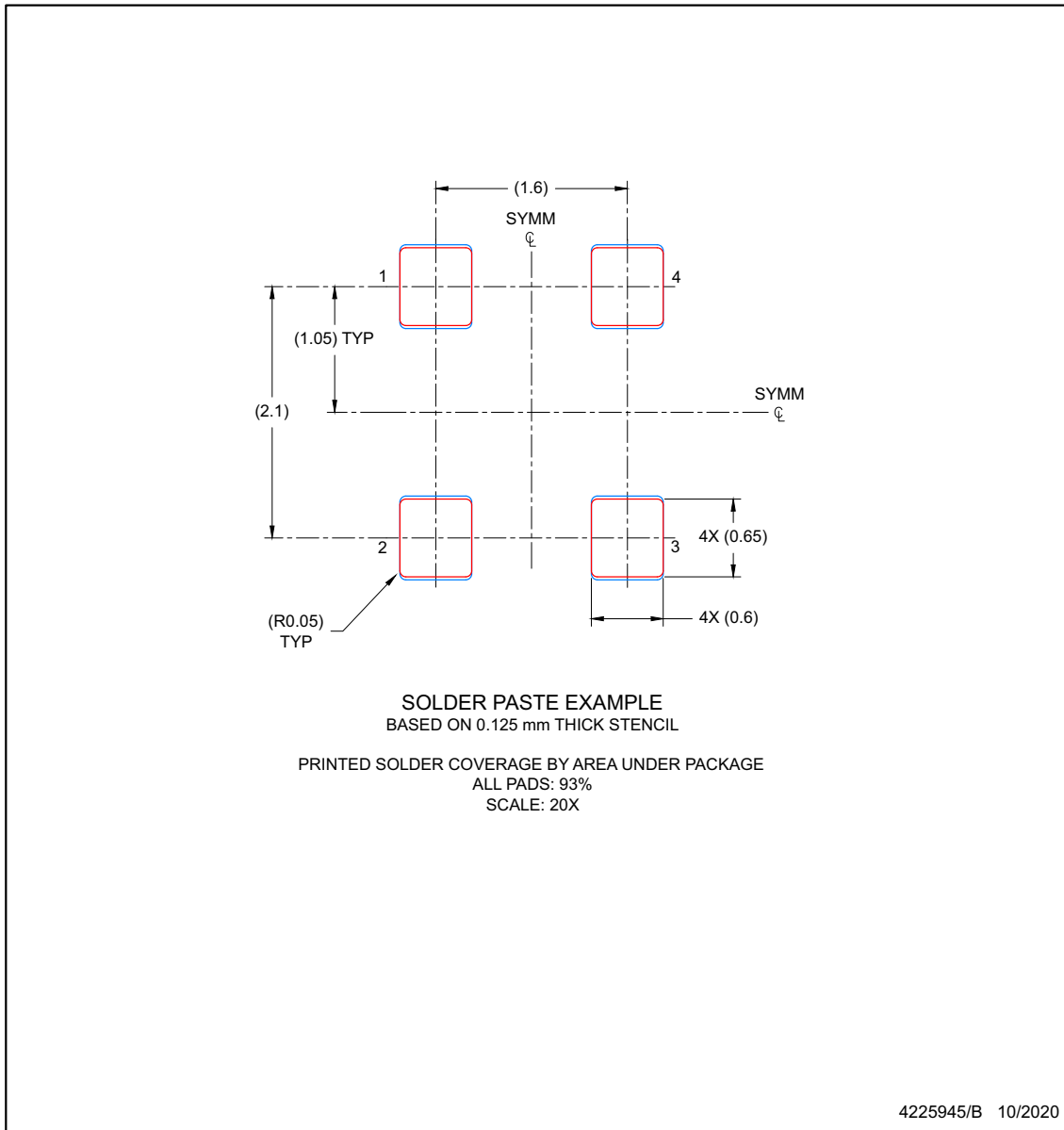

NOTES: (continued)

4. Laser cutting apertures with trapezoidal walls and rounded corners may offer better paste release. IPC-7525 may have alternate design recommendations.

DLX0004A

PACKAGE OUTLINE

VSON - 1 mm max height

PLASTIC QUAD FLAT PACK-NO LEAD

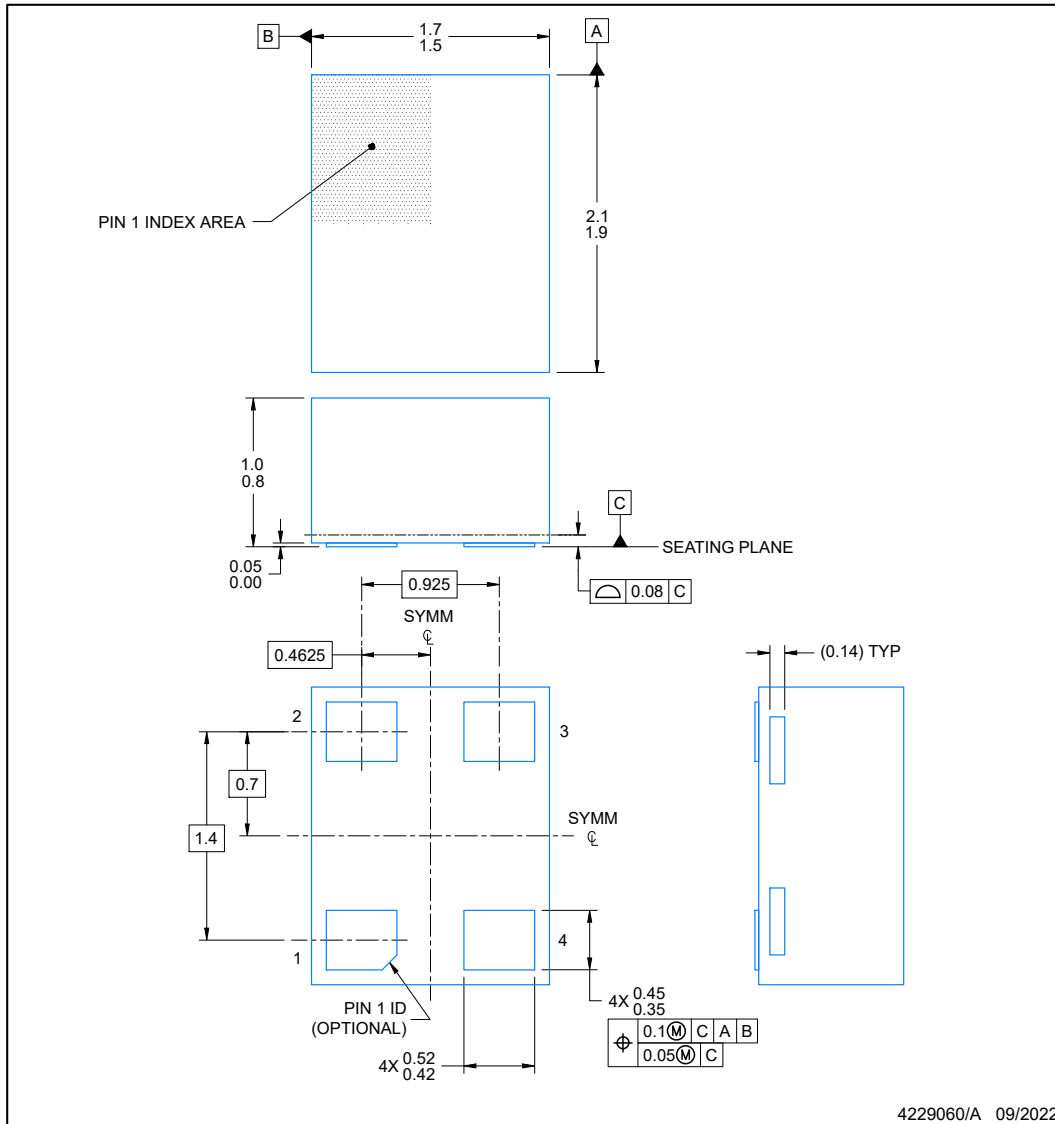

4229060/A 09/2022

NOTES:

1. All linear dimensions are in millimeters. Any dimensions in parenthesis are for reference only. Dimensioning and tolerancing per ASME Y14.5M.
2. This drawing is subject to change without notice.

EXAMPLE BOARD LAYOUT
VSON - 1 mm max height

DLX0004A

PLASTIC QUAD FLAT PACK-NO LEAD

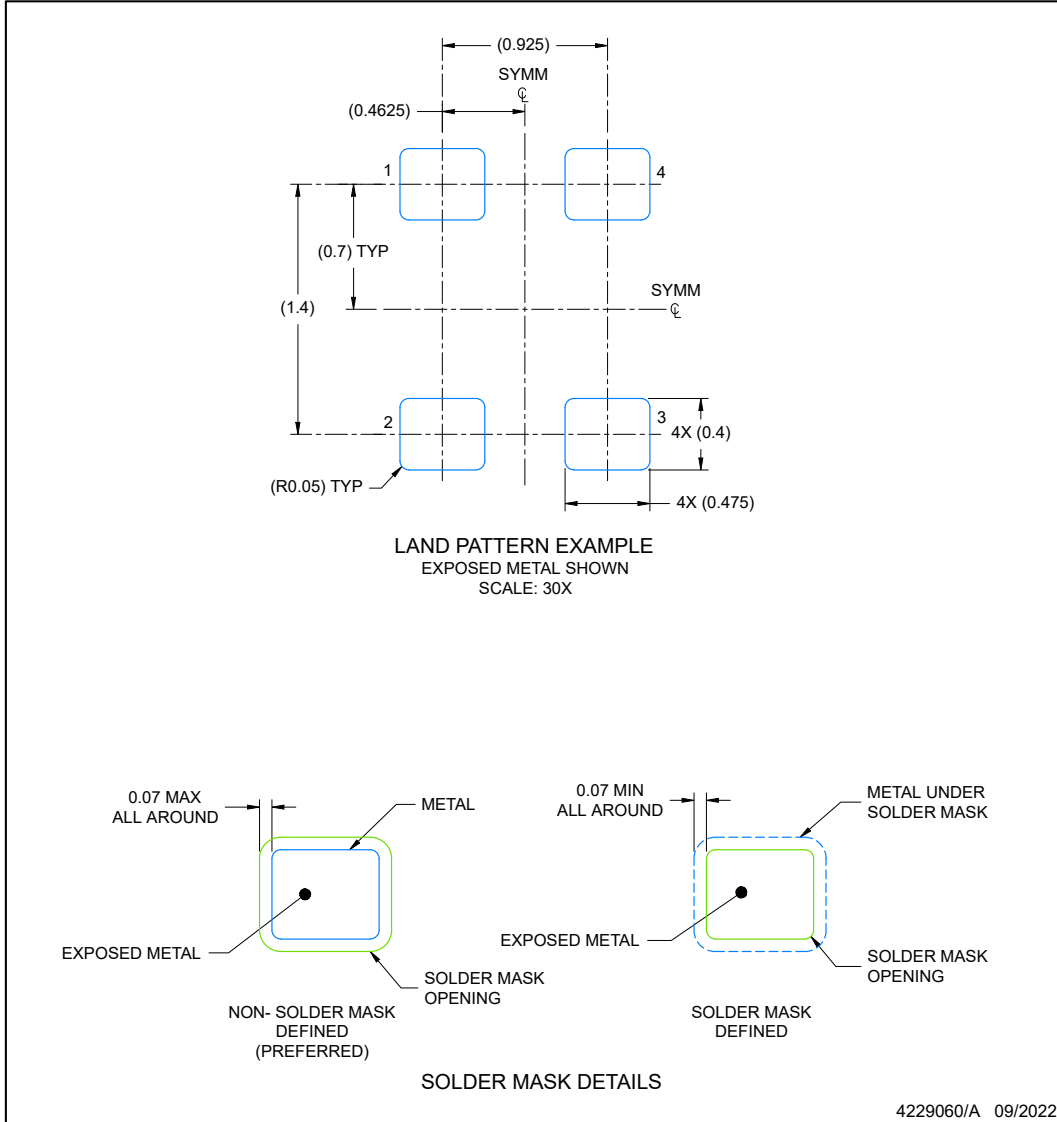

NOTES: (continued)

- For more information, see Texas Instruments literature number SLUA271 (www.ti.com/lit/slua271).

EXAMPLE STENCIL DESIGN

DLX0004A

VSON - 1 mm max height

PLASTIC QUAD FLAT PACK-NO LEAD

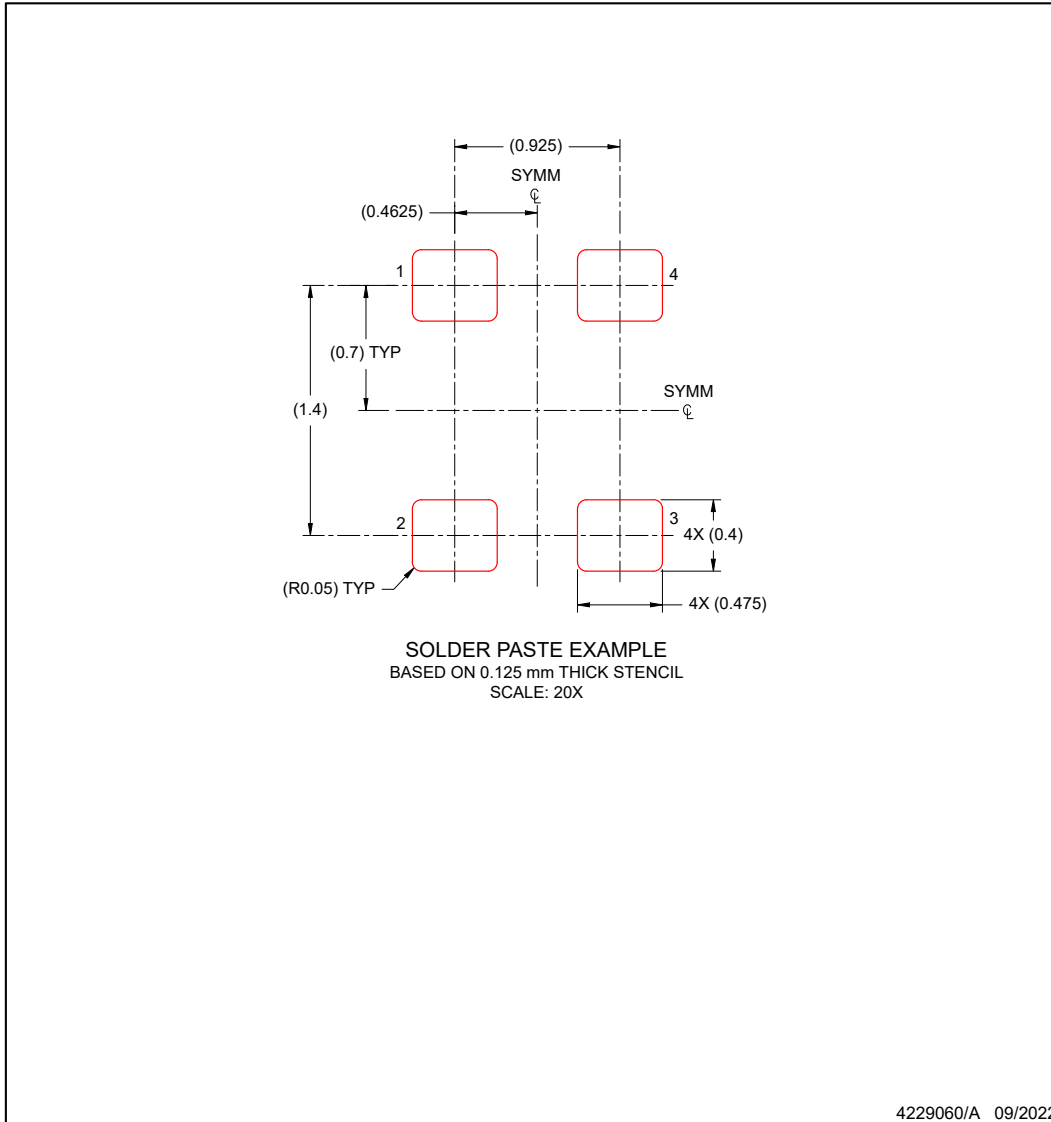

NOTES: (continued)

- 4. Laser cutting apertures with trapezoidal walls and rounded corners may offer better paste release. IPC-7525 may have alternate design recommendations.

12.1 Tape and Reel Information

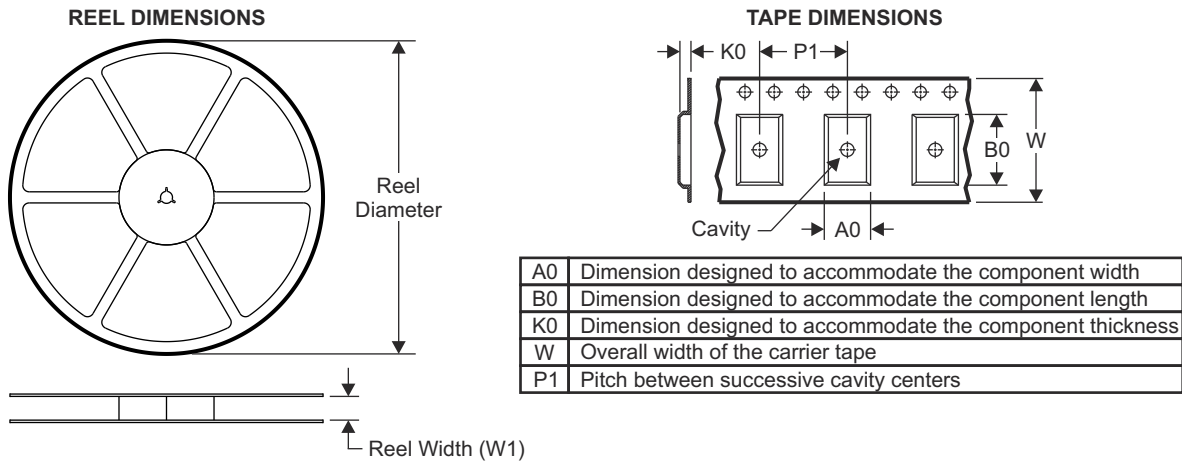

QUADRANT ASSIGNMENTS FOR PIN 1 ORIENTATION IN TAPE

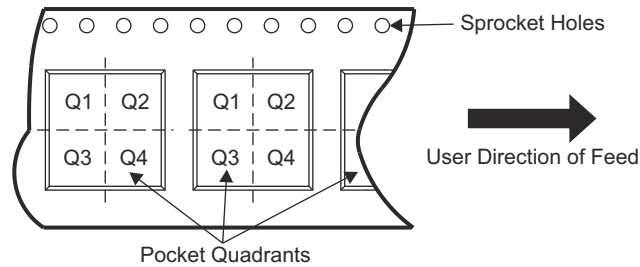

Device	Package Type	Package Drawing	Pins	SPQ	Eco Plan	Reel Diameter (mm)	Reel Width W1 (mm)	A0 (mm)	B0 (mm)	K0 (mm)	P1 (mm)	W (mm)	Pin1 Quadrant
CDC6CE156250 CDLFR	VSON	DLF	4	3000	RoHS & Green	Call TI	Call TI	Call TI	Call TI	Call TI	Call TI	Call TI	Call TI
CDC6CE156250 DDLFT	VSON	DLF	4	3000	RoHS & Green	Call TI	Call TI	Call TI	Call TI	Call TI	Call TI	Call TI	Call TI
CDC6CE002048 ADLER	VSON	DLE	4	3000	RoHS & Green	Call TI	Call TI	Call TI	Call TI	Call TI	Call TI	Call TI	Call TI
CDC6CE002048 ADLFR	VSON	DLF	4	3000	RoHS & Green	Call TI	Call TI	Call TI	Call TI	Call TI	Call TI	Call TI	Call TI
CDC6CE002048 ADLXR	VSON	DLX	4	3000	RoHS & Green	Call TI	Call TI	Call TI	Call TI	Call TI	Call TI	Call TI	Call TI
CDC6CE002048 ADLYR	VSON	DLY	4	3000	RoHS & Green	Call TI	Call TI	Call TI	Call TI	Call TI	Call TI	Call TI	Call TI
CDC6CA002048 ADLER	VSON	DLE	4	3000	RoHS & Green	Call TI	Call TI	Call TI	Call TI	Call TI	Call TI	Call TI	Call TI
CDC6CA002048 ADLFR	VSON	DLF	4	3000	RoHS & Green	Call TI	Call TI	Call TI	Call TI	Call TI	Call TI	Call TI	Call TI
CDC6CA002048 ADLXR	VSON	DLX	4	3000	RoHS & Green	Call TI	Call TI	Call TI	Call TI	Call TI	Call TI	Call TI	Call TI
CDC6CA002048 ADLYR	VSON	DLY	4	3000	RoHS & Green	Call TI	Call TI	Call TI	Call TI	Call TI	Call TI	Call TI	Call TI
CDC6CE004000 ADLER	VSON	DLE	4	3000	RoHS & Green	Call TI	Call TI	Call TI	Call TI	Call TI	Call TI	Call TI	Call TI
CDC6CE004000 ADLFR	VSON	DLF	4	3000	RoHS & Green	Call TI	Call TI	Call TI	Call TI	Call TI	Call TI	Call TI	Call TI
CDC6CE004000 ADLXR	VSON	DLX	4	3000	RoHS & Green	Call TI	Call TI	Call TI	Call TI	Call TI	Call TI	Call TI	Call TI
CDC6CE004000 ADLYR	VSON	DLY	4	3000	RoHS & Green	Call TI	Call TI	Call TI	Call TI	Call TI	Call TI	Call TI	Call TI
CDC6CA004000 ADLER	VSON	DLE	4	3000	RoHS & Green	Call TI	Call TI	Call TI	Call TI	Call TI	Call TI	Call TI	Call TI
CDC6CA004000 ADLFR	VSON	DLF	4	3000	RoHS & Green	Call TI	Call TI	Call TI	Call TI	Call TI	Call TI	Call TI	Call TI
CDC6CA004000 ADLXR	VSON	DLX	4	3000	RoHS & Green	Call TI	Call TI	Call TI	Call TI	Call TI	Call TI	Call TI	Call TI

CDC6C

SNAS843C – DECEMBER 2024 – REVISED JULY 2025

Device	Package Type	Package Drawing	Pins	SPQ	Eco Plan	Reel Diameter (mm)	Reel Width W1 (mm)	A0 (mm)	B0 (mm)	K0 (mm)	P1 (mm)	W (mm)	Pin1 Quadrant
CDC6CA004000 ADLYR	VSON	DLY	4	3000	RoHS & Green	Call TI	Call TI	Call TI	Call TI	Call TI	Call TI	Call TI	Call TI
CDC6CE005120 ADLER	VSON	DLE	4	3000	RoHS & Green	Call TI	Call TI	Call TI	Call TI	Call TI	Call TI	Call TI	Call TI
CDC6CE005120 ADLFR	VSON	DLF	4	3000	RoHS & Green	Call TI	Call TI	Call TI	Call TI	Call TI	Call TI	Call TI	Call TI
CDC6CE005120 ADLXR	VSON	DLX	4	3000	RoHS & Green	Call TI	Call TI	Call TI	Call TI	Call TI	Call TI	Call TI	Call TI
CDC6CE005120 ADLYR	VSON	DLY	4	3000	RoHS & Green	Call TI	Call TI	Call TI	Call TI	Call TI	Call TI	Call TI	Call TI
CDC6CA005120 ADLER	VSON	DLE	4	3000	RoHS & Green	Call TI	Call TI	Call TI	Call TI	Call TI	Call TI	Call TI	Call TI
CDC6CA005120 ADLFR	VSON	DLF	4	3000	RoHS & Green	Call TI	Call TI	Call TI	Call TI	Call TI	Call TI	Call TI	Call TI
CDC6CA005120 ADLXR	VSON	DLX	4	3000	RoHS & Green	Call TI	Call TI	Call TI	Call TI	Call TI	Call TI	Call TI	Call TI
CDC6CA005120 ADLYR	VSON	DLY	4	3000	RoHS & Green	Call TI	Call TI	Call TI	Call TI	Call TI	Call TI	Call TI	Call TI
CDC6CE008000 ADLER	VSON	DLE	4	3000	RoHS & Green	Call TI	Call TI	Call TI	Call TI	Call TI	Call TI	Call TI	Call TI
CDC6CE008000 ADLFR	VSON	DLF	4	3000	RoHS & Green	Call TI	Call TI	Call TI	Call TI	Call TI	Call TI	Call TI	Call TI
CDC6CE008000 ADLXR	VSON	DLX	4	3000	RoHS & Green	Call TI	Call TI	Call TI	Call TI	Call TI	Call TI	Call TI	Call TI
CDC6CE008000 ADLYR	VSON	DLY	4	3000	RoHS & Green	Call TI	Call TI	Call TI	Call TI	Call TI	Call TI	Call TI	Call TI
CDC6CA008000 ADLER	VSON	DLE	4	3000	RoHS & Green	Call TI	Call TI	Call TI	Call TI	Call TI	Call TI	Call TI	Call TI
CDC6CA008000 ADLFR	VSON	DLF	4	3000	RoHS & Green	Call TI	Call TI	Call TI	Call TI	Call TI	Call TI	Call TI	Call TI
CDC6CA008000 ADLXR	VSON	DLX	4	3000	RoHS & Green	Call TI	Call TI	Call TI	Call TI	Call TI	Call TI	Call TI	Call TI
CDC6CA008000 ADLYR	VSON	DLY	4	3000	RoHS & Green	Call TI	Call TI	Call TI	Call TI	Call TI	Call TI	Call TI	Call TI
CDC6CE010000 ADLER	VSON	DLE	4	3000	RoHS & Green	Call TI	Call TI	Call TI	Call TI	Call TI	Call TI	Call TI	Call TI
CDC6CE010000 ADLFR	VSON	DLF	4	3000	RoHS & Green	Call TI	Call TI	Call TI	Call TI	Call TI	Call TI	Call TI	Call TI
CDC6CE010000 ADLXR	VSON	DLX	4	3000	RoHS & Green	Call TI	Call TI	Call TI	Call TI	Call TI	Call TI	Call TI	Call TI
CDC6CE010000 ADLYR	VSON	DLY	4	3000	RoHS & Green	Call TI	Call TI	Call TI	Call TI	Call TI	Call TI	Call TI	Call TI
CDC6CA010000 ADLER	VSON	DLE	4	3000	RoHS & Green	Call TI	Call TI	Call TI	Call TI	Call TI	Call TI	Call TI	Call TI
CDC6CA010000 ADLFR	VSON	DLF	4	3000	RoHS & Green	Call TI	Call TI	Call TI	Call TI	Call TI	Call TI	Call TI	Call TI
CDC6CA010000 ADLXR	VSON	DLX	4	3000	RoHS & Green	Call TI	Call TI	Call TI	Call TI	Call TI	Call TI	Call TI	Call TI
CDC6CA010000 ADLYR	VSON	DLY	4	3000	RoHS & Green	Call TI	Call TI	Call TI	Call TI	Call TI	Call TI	Call TI	Call TI
CDC6CE012000 ADLER	VSON	DLE	4	3000	RoHS & Green	Call TI	Call TI	Call TI	Call TI	Call TI	Call TI	Call TI	Call TI
CDC6CE012000 ADLFR	VSON	DLF	4	3000	RoHS & Green	Call TI	Call TI	Call TI	Call TI	Call TI	Call TI	Call TI	Call TI
CDC6CE012000 ADLXR	VSON	DLX	4	3000	RoHS & Green	Call TI	Call TI	Call TI	Call TI	Call TI	Call TI	Call TI	Call TI
CDC6CE012000 ADLYR	VSON	DLY	4	3000	RoHS & Green	Call TI	Call TI	Call TI	Call TI	Call TI	Call TI	Call TI	Call TI
CDC6CA012000 ADLER	VSON	DLE	4	3000	RoHS & Green	Call TI	Call TI	Call TI	Call TI	Call TI	Call TI	Call TI	Call TI
CDC6CA012000 ADLFR	VSON	DLF	4	3000	RoHS & Green	Call TI	Call TI	Call TI	Call TI	Call TI	Call TI	Call TI	Call TI
CDC6CA012000 ADLXR	VSON	DLX	4	3000	RoHS & Green	Call TI	Call TI	Call TI	Call TI	Call TI	Call TI	Call TI	Call TI
CDC6CA012000 ADLYR	VSON	DLY	4	3000	RoHS & Green	Call TI	Call TI	Call TI	Call TI	Call TI	Call TI	Call TI	Call TI

Device	Package Type	Package Drawing	Pins	SPQ	Eco Plan	Reel Diameter (mm)	Reel Width W1 (mm)	A0 (mm)	B0 (mm)	K0 (mm)	P1 (mm)	W (mm)	Pin1 Quadrant
CDC6CE012288 ADLER	VSON	DLE	4	3000	RoHS & Green	Call TI	Call TI	Call TI	Call TI	Call TI	Call TI	Call TI	Call TI
CDC6CE012288 ADLFR	VSON	DLF	4	3000	RoHS & Green	Call TI	Call TI	Call TI	Call TI	Call TI	Call TI	Call TI	Call TI
CDC6CE012288 ADLXR	VSON	DLX	4	3000	RoHS & Green	Call TI	Call TI	Call TI	Call TI	Call TI	Call TI	Call TI	Call TI
CDC6CE012288 ADLYR	VSON	DLY	4	3000	RoHS & Green	Call TI	Call TI	Call TI	Call TI	Call TI	Call TI	Call TI	Call TI
CDC6CA012288 ADLER	VSON	DLE	4	3000	RoHS & Green	Call TI	Call TI	Call TI	Call TI	Call TI	Call TI	Call TI	Call TI
CDC6CA012288 ADLFR	VSON	DLF	4	3000	RoHS & Green	Call TI	Call TI	Call TI	Call TI	Call TI	Call TI	Call TI	Call TI
CDC6CA012288 ADLXR	VSON	DLX	4	3000	RoHS & Green	Call TI	Call TI	Call TI	Call TI	Call TI	Call TI	Call TI	Call TI
CDC6CA012288 ADLYR	VSON	DLY	4	3000	RoHS & Green	Call TI	Call TI	Call TI	Call TI	Call TI	Call TI	Call TI	Call TI
CDC6CE016000 ADLER	VSON	DLE	4	3000	RoHS & Green	Call TI	Call TI	Call TI	Call TI	Call TI	Call TI	Call TI	Call TI
CDC6CE016000 ADLFR	VSON	DLF	4	3000	RoHS & Green	Call TI	Call TI	Call TI	Call TI	Call TI	Call TI	Call TI	Call TI
CDC6CE016000 ADLXR	VSON	DLX	4	3000	RoHS & Green	Call TI	Call TI	Call TI	Call TI	Call TI	Call TI	Call TI	Call TI
CDC6CE016000 ADLYR	VSON	DLY	4	3000	RoHS & Green	Call TI	Call TI	Call TI	Call TI	Call TI	Call TI	Call TI	Call TI
CDC6CA016000 ADLER	VSON	DLE	4	3000	RoHS & Green	Call TI	Call TI	Call TI	Call TI	Call TI	Call TI	Call TI	Call TI
CDC6CA016000 ADLFR	VSON	DLF	4	3000	RoHS & Green	Call TI	Call TI	Call TI	Call TI	Call TI	Call TI	Call TI	Call TI
CDC6CA016000 ADLXR	VSON	DLX	4	3000	RoHS & Green	Call TI	Call TI	Call TI	Call TI	Call TI	Call TI	Call TI	Call TI
CDC6CA016000 ADLYR	VSON	DLY	4	3000	RoHS & Green	Call TI	Call TI	Call TI	Call TI	Call TI	Call TI	Call TI	Call TI
CDC6CE019200 ADLER	VSON	DLE	4	3000	RoHS & Green	Call TI	Call TI	Call TI	Call TI	Call TI	Call TI	Call TI	Call TI
CDC6CE019200 ADLFR	VSON	DLF	4	3000	RoHS & Green	Call TI	Call TI	Call TI	Call TI	Call TI	Call TI	Call TI	Call TI
CDC6CE019200 ADLXR	VSON	DLX	4	3000	RoHS & Green	Call TI	Call TI	Call TI	Call TI	Call TI	Call TI	Call TI	Call TI
CDC6CE019200 ADLYR	VSON	DLY	4	3000	RoHS & Green	Call TI	Call TI	Call TI	Call TI	Call TI	Call TI	Call TI	Call TI
CDC6CA019200 ADLER	VSON	DLE	4	3000	RoHS & Green	Call TI	Call TI	Call TI	Call TI	Call TI	Call TI	Call TI	Call TI
CDC6CA019200 ADLFR	VSON	DLF	4	3000	RoHS & Green	Call TI	Call TI	Call TI	Call TI	Call TI	Call TI	Call TI	Call TI
CDC6CA019200 ADLXR	VSON	DLX	4	3000	RoHS & Green	Call TI	Call TI	Call TI	Call TI	Call TI	Call TI	Call TI	Call TI
CDC6CA019200 ADLYR	VSON	DLY	4	3000	RoHS & Green	Call TI	Call TI	Call TI	Call TI	Call TI	Call TI	Call TI	Call TI
CDC6CE020000 ADLER	VSON	DLE	4	3000	RoHS & Green	Call TI	Call TI	Call TI	Call TI	Call TI	Call TI	Call TI	Call TI
CDC6CE020000 ADLFR	VSON	DLF	4	3000	RoHS & Green	Call TI	Call TI	Call TI	Call TI	Call TI	Call TI	Call TI	Call TI
CDC6CE020000 ADLXR	VSON	DLX	4	3000	RoHS & Green	Call TI	Call TI	Call TI	Call TI	Call TI	Call TI	Call TI	Call TI
CDC6CE020000 ADLYR	VSON	DLY	4	3000	RoHS & Green	Call TI	Call TI	Call TI	Call TI	Call TI	Call TI	Call TI	Call TI
CDC6CA020000 ADLER	VSON	DLE	4	3000	RoHS & Green	Call TI	Call TI	Call TI	Call TI	Call TI	Call TI	Call TI	Call TI
CDC6CA020000 ADLFR	VSON	DLF	4	3000	RoHS & Green	Call TI	Call TI	Call TI	Call TI	Call TI	Call TI	Call TI	Call TI
CDC6CA020000 ADLXR	VSON	DLX	4	3000	RoHS & Green	Call TI	Call TI	Call TI	Call TI	Call TI	Call TI	Call TI	Call TI
CDC6CA020000 ADLYR	VSON	DLY	4	3000	RoHS & Green	Call TI	Call TI	Call TI	Call TI	Call TI	Call TI	Call TI	Call TI
CDC6CE023500 ADLER	VSON	DLE	4	3000	RoHS & Green	Call TI	Call TI	Call TI	Call TI	Call TI	Call TI	Call TI	Call TI

CDC6C

SNAS843C – DECEMBER 2024 – REVISED JULY 2025

Device	Package Type	Package Drawing	Pins	SPQ	Eco Plan	Reel Diameter (mm)	Reel Width W1 (mm)	A0 (mm)	B0 (mm)	K0 (mm)	P1 (mm)	W (mm)	Pin1 Quadrant
CDC6CE023500 ADLFR	VSON	DLF	4	3000	RoHS & Green	Call TI	Call TI	Call TI	Call TI	Call TI	Call TI	Call TI	Call TI
CDC6CE023500 ADLXR	VSON	DLX	4	3000	RoHS & Green	Call TI	Call TI	Call TI	Call TI	Call TI	Call TI	Call TI	Call TI
CDC6CE023500 ADLYR	VSON	DLY	4	3000	RoHS & Green	Call TI	Call TI	Call TI	Call TI	Call TI	Call TI	Call TI	Call TI
CDC6CA023500 ADLER	VSON	DLE	4	3000	RoHS & Green	Call TI	Call TI	Call TI	Call TI	Call TI	Call TI	Call TI	Call TI
CDC6CA023500 ADLFR	VSON	DLF	4	3000	RoHS & Green	Call TI	Call TI	Call TI	Call TI	Call TI	Call TI	Call TI	Call TI
CDC6CA023500 ADLXR	VSON	DLX	4	3000	RoHS & Green	Call TI	Call TI	Call TI	Call TI	Call TI	Call TI	Call TI	Call TI
CDC6CA023500 ADLYR	VSON	DLY	4	3000	RoHS & Green	Call TI	Call TI	Call TI	Call TI	Call TI	Call TI	Call TI	Call TI
CDC6CE024000 ADLER	VSON	DLE	4	3000	RoHS & Green	Call TI	Call TI	Call TI	Call TI	Call TI	Call TI	Call TI	Call TI
CDC6CE024000 ADLFR	VSON	DLF	4	3000	RoHS & Green	Call TI	Call TI	Call TI	Call TI	Call TI	Call TI	Call TI	Call TI
CDC6CE024000 ADLXR	VSON	DLX	4	3000	RoHS & Green	Call TI	Call TI	Call TI	Call TI	Call TI	Call TI	Call TI	Call TI
CDC6CE024000 ADLYR	VSON	DLY	4	3000	RoHS & Green	Call TI	Call TI	Call TI	Call TI	Call TI	Call TI	Call TI	Call TI
CDC6CA024000 ADLER	VSON	DLE	4	3000	RoHS & Green	Call TI	Call TI	Call TI	Call TI	Call TI	Call TI	Call TI	Call TI
CDC6CA024000 ADLFR	VSON	DLF	4	3000	RoHS & Green	Call TI	Call TI	Call TI	Call TI	Call TI	Call TI	Call TI	Call TI
CDC6CA024000 ADLXR	VSON	DLX	4	3000	RoHS & Green	Call TI	Call TI	Call TI	Call TI	Call TI	Call TI	Call TI	Call TI
CDC6CA024000 ADLYR	VSON	DLY	4	3000	RoHS & Green	Call TI	Call TI	Call TI	Call TI	Call TI	Call TI	Call TI	Call TI
CDC6CE024576 ADLER	VSON	DLE	4	3000	RoHS & Green	Call TI	Call TI	Call TI	Call TI	Call TI	Call TI	Call TI	Call TI
CDC6CE024576 ADLFR	VSON	DLF	4	3000	RoHS & Green	Call TI	Call TI	Call TI	Call TI	Call TI	Call TI	Call TI	Call TI
CDC6CE024576 ADLXR	VSON	DLX	4	3000	RoHS & Green	Call TI	Call TI	Call TI	Call TI	Call TI	Call TI	Call TI	Call TI
CDC6CE024576 ADLYR	VSON	DLY	4	3000	RoHS & Green	Call TI	Call TI	Call TI	Call TI	Call TI	Call TI	Call TI	Call TI
CDC6CA024576 ADLER	VSON	DLE	4	3000	RoHS & Green	Call TI	Call TI	Call TI	Call TI	Call TI	Call TI	Call TI	Call TI
CDC6CA024576 ADLFR	VSON	DLF	4	3000	RoHS & Green	Call TI	Call TI	Call TI	Call TI	Call TI	Call TI	Call TI	Call TI
CDC6CA024576 ADLXR	VSON	DLX	4	3000	RoHS & Green	Call TI	Call TI	Call TI	Call TI	Call TI	Call TI	Call TI	Call TI
CDC6CA024576 ADLYR	VSON	DLY	4	3000	RoHS & Green	Call TI	Call TI	Call TI	Call TI	Call TI	Call TI	Call TI	Call TI
CDC6CE025000 ADLER	VSON	DLE	4	3000	RoHS & Green	Call TI	Call TI	Call TI	Call TI	Call TI	Call TI	Call TI	Call TI
CDC6CE025000 ADLFR	VSON	DLF	4	3000	RoHS & Green	Call TI	Call TI	Call TI	Call TI	Call TI	Call TI	Call TI	Call TI
CDC6CE025000 ADLXR	VSON	DLX	4	3000	RoHS & Green	Call TI	Call TI	Call TI	Call TI	Call TI	Call TI	Call TI	Call TI
CDC6CE025000 ADLYR	VSON	DLY	4	3000	RoHS & Green	Call TI	Call TI	Call TI	Call TI	Call TI	Call TI	Call TI	Call TI
CDC6CA025000 ADLER	VSON	DLE	4	3000	RoHS & Green	Call TI	Call TI	Call TI	Call TI	Call TI	Call TI	Call TI	Call TI
CDC6CA025000 ADLFR	VSON	DLF	4	3000	RoHS & Green	Call TI	Call TI	Call TI	Call TI	Call TI	Call TI	Call TI	Call TI
CDC6CA025000 ADLXR	VSON	DLX	4	3000	RoHS & Green	Call TI	Call TI	Call TI	Call TI	Call TI	Call TI	Call TI	Call TI
CDC6CA025000 ADLYR	VSON	DLY	4	3000	RoHS & Green	Call TI	Call TI	Call TI	Call TI	Call TI	Call TI	Call TI	Call TI
CDC6CE026000 ADLER	VSON	DLE	4	3000	RoHS & Green	Call TI	Call TI	Call TI	Call TI	Call TI	Call TI	Call TI	Call TI
CDC6CE026000 ADLFR	VSON	DLF	4	3000	RoHS & Green	Call TI	Call TI	Call TI	Call TI	Call TI	Call TI	Call TI	Call TI

Device	Package Type	Package Drawing	Pins	SPQ	Eco Plan	Reel Diameter (mm)	Reel Width W1 (mm)	A0 (mm)	B0 (mm)	K0 (mm)	P1 (mm)	W (mm)	Pin1 Quadrant
CDC6CE026000 ADLXR	VSON	DLX	4	3000	RoHS & Green	Call TI	Call TI	Call TI	Call TI	Call TI	Call TI	Call TI	Call TI
CDC6CE026000 ADLYR	VSON	DLY	4	3000	RoHS & Green	Call TI	Call TI	Call TI	Call TI	Call TI	Call TI	Call TI	Call TI
CDC6CA026000 ADLER	VSON	DLE	4	3000	RoHS & Green	Call TI	Call TI	Call TI	Call TI	Call TI	Call TI	Call TI	Call TI
CDC6CA026000 ADLFR	VSON	DLF	4	3000	RoHS & Green	Call TI	Call TI	Call TI	Call TI	Call TI	Call TI	Call TI	Call TI
CDC6CA026000 ADLXR	VSON	DLX	4	3000	RoHS & Green	Call TI	Call TI	Call TI	Call TI	Call TI	Call TI	Call TI	Call TI
CDC6CA026000 ADLYR	VSON	DLY	4	3000	RoHS & Green	Call TI	Call TI	Call TI	Call TI	Call TI	Call TI	Call TI	Call TI
CDC6CE026214 ADLER	VSON	DLE	4	3000	RoHS & Green	Call TI	Call TI	Call TI	Call TI	Call TI	Call TI	Call TI	Call TI
CDC6CE026214 ADLFR	VSON	DLF	4	3000	RoHS & Green	Call TI	Call TI	Call TI	Call TI	Call TI	Call TI	Call TI	Call TI
CDC6CE026214 ADLXR	VSON	DLX	4	3000	RoHS & Green	Call TI	Call TI	Call TI	Call TI	Call TI	Call TI	Call TI	Call TI
CDC6CE026214 ADLYR	VSON	DLY	4	3000	RoHS & Green	Call TI	Call TI	Call TI	Call TI	Call TI	Call TI	Call TI	Call TI
CDC6CA026214 ADLER	VSON	DLE	4	3000	RoHS & Green	Call TI	Call TI	Call TI	Call TI	Call TI	Call TI	Call TI	Call TI
CDC6CA026214 ADLFR	VSON	DLF	4	3000	RoHS & Green	Call TI	Call TI	Call TI	Call TI	Call TI	Call TI	Call TI	Call TI
CDC6CA026214 ADLXR	VSON	DLX	4	3000	RoHS & Green	Call TI	Call TI	Call TI	Call TI	Call TI	Call TI	Call TI	Call TI
CDC6CA026214 ADLYR	VSON	DLY	4	3000	RoHS & Green	Call TI	Call TI	Call TI	Call TI	Call TI	Call TI	Call TI	Call TI
CDC6CE027000 ADLER	VSON	DLE	4	3000	RoHS & Green	Call TI	Call TI	Call TI	Call TI	Call TI	Call TI	Call TI	Call TI
CDC6CE027000 ADLFR	VSON	DLF	4	3000	RoHS & Green	Call TI	Call TI	Call TI	Call TI	Call TI	Call TI	Call TI	Call TI
CDC6CE027000 ADLXR	VSON	DLX	4	3000	RoHS & Green	Call TI	Call TI	Call TI	Call TI	Call TI	Call TI	Call TI	Call TI
CDC6CE027000 ADLYR	VSON	DLY	4	3000	RoHS & Green	Call TI	Call TI	Call TI	Call TI	Call TI	Call TI	Call TI	Call TI
CDC6CA027000 ADLER	VSON	DLE	4	3000	RoHS & Green	Call TI	Call TI	Call TI	Call TI	Call TI	Call TI	Call TI	Call TI
CDC6CA027000 ADLFR	VSON	DLF	4	3000	RoHS & Green	Call TI	Call TI	Call TI	Call TI	Call TI	Call TI	Call TI	Call TI
CDC6CA027000 ADLXR	VSON	DLX	4	3000	RoHS & Green	Call TI	Call TI	Call TI	Call TI	Call TI	Call TI	Call TI	Call TI
CDC6CA027000 ADLYR	VSON	DLY	4	3000	RoHS & Green	Call TI	Call TI	Call TI	Call TI	Call TI	Call TI	Call TI	Call TI
CDC6CE028125 ADLER	VSON	DLE	4	3000	RoHS & Green	Call TI	Call TI	Call TI	Call TI	Call TI	Call TI	Call TI	Call TI
CDC6CE028125 ADLFR	VSON	DLF	4	3000	RoHS & Green	Call TI	Call TI	Call TI	Call TI	Call TI	Call TI	Call TI	Call TI
CDC6CE028125 ADLXR	VSON	DLX	4	3000	RoHS & Green	Call TI	Call TI	Call TI	Call TI	Call TI	Call TI	Call TI	Call TI
CDC6CE028125 ADLYR	VSON	DLY	4	3000	RoHS & Green	Call TI	Call TI	Call TI	Call TI	Call TI	Call TI	Call TI	Call TI
CDC6CA028125 ADLER	VSON	DLE	4	3000	RoHS & Green	Call TI	Call TI	Call TI	Call TI	Call TI	Call TI	Call TI	Call TI
CDC6CA028125 ADLFR	VSON	DLF	4	3000	RoHS & Green	Call TI	Call TI	Call TI	Call TI	Call TI	Call TI	Call TI	Call TI
CDC6CA028125 ADLXR	VSON	DLX	4	3000	RoHS & Green	Call TI	Call TI	Call TI	Call TI	Call TI	Call TI	Call TI	Call TI
CDC6CA028125 ADLYR	VSON	DLY	4	3000	RoHS & Green	Call TI	Call TI	Call TI	Call TI	Call TI	Call TI	Call TI	Call TI
CDC6CE029992 ADLER	VSON	DLE	4	3000	RoHS & Green	Call TI	Call TI	Call TI	Call TI	Call TI	Call TI	Call TI	Call TI
CDC6CE029992 ADLFR	VSON	DLF	4	3000	RoHS & Green	Call TI	Call TI	Call TI	Call TI	Call TI	Call TI	Call TI	Call TI
CDC6CE029992 ADLXR	VSON	DLX	4	3000	RoHS & Green	Call TI	Call TI	Call TI	Call TI	Call TI	Call TI	Call TI	Call TI

CDC6C

SNAS843C – DECEMBER 2024 – REVISED JULY 2025

Device	Package Type	Package Drawing	Pins	SPQ	Eco Plan	Reel Diameter (mm)	Reel Width W1 (mm)	A0 (mm)	B0 (mm)	K0 (mm)	P1 (mm)	W (mm)	Pin1 Quadrant
CDC6CE029992 ADLYR	VSON	DLY	4	3000	RoHS & Green	Call TI	Call TI	Call TI	Call TI	Call TI	Call TI	Call TI	Call TI
CDC6CA029992 ADLER	VSON	DLE	4	3000	RoHS & Green	Call TI	Call TI	Call TI	Call TI	Call TI	Call TI	Call TI	Call TI
CDC6CA029992 ADLFR	VSON	DLF	4	3000	RoHS & Green	Call TI	Call TI	Call TI	Call TI	Call TI	Call TI	Call TI	Call TI
CDC6CA029992 ADLXR	VSON	DLX	4	3000	RoHS & Green	Call TI	Call TI	Call TI	Call TI	Call TI	Call TI	Call TI	Call TI
CDC6CA029992 ADLYR	VSON	DLY	4	3000	RoHS & Green	Call TI	Call TI	Call TI	Call TI	Call TI	Call TI	Call TI	Call TI
CDC6CE030000 ADLER	VSON	DLE	4	3000	RoHS & Green	Call TI	Call TI	Call TI	Call TI	Call TI	Call TI	Call TI	Call TI
CDC6CE030000 ADLFR	VSON	DLF	4	3000	RoHS & Green	Call TI	Call TI	Call TI	Call TI	Call TI	Call TI	Call TI	Call TI
CDC6CE030000 ADLXR	VSON	DLX	4	3000	RoHS & Green	Call TI	Call TI	Call TI	Call TI	Call TI	Call TI	Call TI	Call TI
CDC6CE030000 ADLYR	VSON	DLY	4	3000	RoHS & Green	Call TI	Call TI	Call TI	Call TI	Call TI	Call TI	Call TI	Call TI
CDC6CA030000 ADLER	VSON	DLE	4	3000	RoHS & Green	Call TI	Call TI	Call TI	Call TI	Call TI	Call TI	Call TI	Call TI
CDC6CA030000 ADLFR	VSON	DLF	4	3000	RoHS & Green	Call TI	Call TI	Call TI	Call TI	Call TI	Call TI	Call TI	Call TI
CDC6CA030000 ADLXR	VSON	DLX	4	3000	RoHS & Green	Call TI	Call TI	Call TI	Call TI	Call TI	Call TI	Call TI	Call TI
CDC6CA030000 ADLYR	VSON	DLY	4	3000	RoHS & Green	Call TI	Call TI	Call TI	Call TI	Call TI	Call TI	Call TI	Call TI
CDC6CE032768 ADLER	VSON	DLE	4	3000	RoHS & Green	Call TI	Call TI	Call TI	Call TI	Call TI	Call TI	Call TI	Call TI
CDC6CE032768 ADLFR	VSON	DLF	4	3000	RoHS & Green	Call TI	Call TI	Call TI	Call TI	Call TI	Call TI	Call TI	Call TI
CDC6CE032768 ADLXR	VSON	DLX	4	3000	RoHS & Green	Call TI	Call TI	Call TI	Call TI	Call TI	Call TI	Call TI	Call TI
CDC6CE032768 ADLYR	VSON	DLY	4	3000	RoHS & Green	Call TI	Call TI	Call TI	Call TI	Call TI	Call TI	Call TI	Call TI
CDC6CA032768 ADLER	VSON	DLE	4	3000	RoHS & Green	Call TI	Call TI	Call TI	Call TI	Call TI	Call TI	Call TI	Call TI
CDC6CA032768 ADLFR	VSON	DLF	4	3000	RoHS & Green	Call TI	Call TI	Call TI	Call TI	Call TI	Call TI	Call TI	Call TI
CDC6CA032768 ADLXR	VSON	DLX	4	3000	RoHS & Green	Call TI	Call TI	Call TI	Call TI	Call TI	Call TI	Call TI	Call TI
CDC6CA032768 ADLYR	VSON	DLY	4	3000	RoHS & Green	Call TI	Call TI	Call TI	Call TI	Call TI	Call TI	Call TI	Call TI
CDC6CE033333 ADLER	VSON	DLE	4	3000	RoHS & Green	Call TI	Call TI	Call TI	Call TI	Call TI	Call TI	Call TI	Call TI
CDC6CE033333 ADLFR	VSON	DLF	4	3000	RoHS & Green	Call TI	Call TI	Call TI	Call TI	Call TI	Call TI	Call TI	Call TI
CDC6CE033333 ADLXR	VSON	DLX	4	3000	RoHS & Green	Call TI	Call TI	Call TI	Call TI	Call TI	Call TI	Call TI	Call TI
CDC6CE033333 ADLYR	VSON	DLY	4	3000	RoHS & Green	Call TI	Call TI	Call TI	Call TI	Call TI	Call TI	Call TI	Call TI
CDC6CA033333 ADLER	VSON	DLE	4	3000	RoHS & Green	Call TI	Call TI	Call TI	Call TI	Call TI	Call TI	Call TI	Call TI
CDC6CA033333 ADLFR	VSON	DLF	4	3000	RoHS & Green	Call TI	Call TI	Call TI	Call TI	Call TI	Call TI	Call TI	Call TI
CDC6CA033333 ADLXR	VSON	DLX	4	3000	RoHS & Green	Call TI	Call TI	Call TI	Call TI	Call TI	Call TI	Call TI	Call TI
CDC6CA033333 ADLYR	VSON	DLY	4	3000	RoHS & Green	Call TI	Call TI	Call TI	Call TI	Call TI	Call TI	Call TI	Call TI
CDC6CE038400 ADLER	VSON	DLE	4	3000	RoHS & Green	Call TI	Call TI	Call TI	Call TI	Call TI	Call TI	Call TI	Call TI
CDC6CE038400 ADLFR	VSON	DLF	4	3000	RoHS & Green	Call TI	Call TI	Call TI	Call TI	Call TI	Call TI	Call TI	Call TI
CDC6CE038400 ADLXR	VSON	DLX	4	3000	RoHS & Green	Call TI	Call TI	Call TI	Call TI	Call TI	Call TI	Call TI	Call TI
CDC6CE038400 ADLYR	VSON	DLY	4	3000	RoHS & Green	Call TI	Call TI	Call TI	Call TI	Call TI	Call TI	Call TI	Call TI

Device	Package Type	Package Drawing	Pins	SPQ	Eco Plan	Reel Diameter (mm)	Reel Width W1 (mm)	A0 (mm)	B0 (mm)	K0 (mm)	P1 (mm)	W (mm)	Pin1 Quadrant
CDC6CA038400 ADLER	VSON	DLE	4	3000	RoHS & Green	Call TI	Call TI	Call TI	Call TI	Call TI	Call TI	Call TI	Call TI
CDC6CA038400 ADLFR	VSON	DLF	4	3000	RoHS & Green	Call TI	Call TI	Call TI	Call TI	Call TI	Call TI	Call TI	Call TI
CDC6CA038400 ADLXR	VSON	DLX	4	3000	RoHS & Green	Call TI	Call TI	Call TI	Call TI	Call TI	Call TI	Call TI	Call TI
CDC6CA038400 ADLYR	VSON	DLY	4	3000	RoHS & Green	Call TI	Call TI	Call TI	Call TI	Call TI	Call TI	Call TI	Call TI
CDC6CE040000 ADLER	VSON	DLE	4	3000	RoHS & Green	Call TI	Call TI	Call TI	Call TI	Call TI	Call TI	Call TI	Call TI
CDC6CE040000 ADLFR	VSON	DLF	4	3000	RoHS & Green	Call TI	Call TI	Call TI	Call TI	Call TI	Call TI	Call TI	Call TI
CDC6CE040000 ADLXR	VSON	DLX	4	3000	RoHS & Green	Call TI	Call TI	Call TI	Call TI	Call TI	Call TI	Call TI	Call TI
CDC6CE040000 ADLYR	VSON	DLY	4	3000	RoHS & Green	Call TI	Call TI	Call TI	Call TI	Call TI	Call TI	Call TI	Call TI
CDC6CA040000 ADLER	VSON	DLE	4	3000	RoHS & Green	Call TI	Call TI	Call TI	Call TI	Call TI	Call TI	Call TI	Call TI
CDC6CA040000 ADLFR	VSON	DLF	4	3000	RoHS & Green	Call TI	Call TI	Call TI	Call TI	Call TI	Call TI	Call TI	Call TI
CDC6CA040000 ADLXR	VSON	DLX	4	3000	RoHS & Green	Call TI	Call TI	Call TI	Call TI	Call TI	Call TI	Call TI	Call TI
CDC6CA040000 ADLYR	VSON	DLY	4	3000	RoHS & Green	Call TI	Call TI	Call TI	Call TI	Call TI	Call TI	Call TI	Call TI
CDC6CA048000 ADLER	VSON	DLE	4	3000	RoHS & Green	Call TI	Call TI	Call TI	Call TI	Call TI	Call TI	Call TI	Call TI
CDC6CA048000 ADLFR	VSON	DLF	4	3000	RoHS & Green	Call TI	Call TI	Call TI	Call TI	Call TI	Call TI	Call TI	Call TI
CDC6CA048000 ADLXR	VSON	DLX	4	3000	RoHS & Green	Call TI	Call TI	Call TI	Call TI	Call TI	Call TI	Call TI	Call TI
CDC6CA048000 ADLYR	VSON	DLY	4	3000	RoHS & Green	Call TI	Call TI	Call TI	Call TI	Call TI	Call TI	Call TI	Call TI
CDC6CA048000 ADLER	VSON	DLE	4	3000	RoHS & Green	Call TI	Call TI	Call TI	Call TI	Call TI	Call TI	Call TI	Call TI
CDC6CA048000 ADLFR	VSON	DLF	4	3000	RoHS & Green	Call TI	Call TI	Call TI	Call TI	Call TI	Call TI	Call TI	Call TI
CDC6CA048000 ADLXR	VSON	DLX	4	3000	RoHS & Green	Call TI	Call TI	Call TI	Call TI	Call TI	Call TI	Call TI	Call TI
CDC6CA048000 ADLYR	VSON	DLY	4	3000	RoHS & Green	Call TI	Call TI	Call TI	Call TI	Call TI	Call TI	Call TI	Call TI
CDC6CE049152 ADLER	VSON	DLE	4	3000	RoHS & Green	Call TI	Call TI	Call TI	Call TI	Call TI	Call TI	Call TI	Call TI
CDC6CE049152 ADLFR	VSON	DLF	4	3000	RoHS & Green	Call TI	Call TI	Call TI	Call TI	Call TI	Call TI	Call TI	Call TI
CDC6CE049152 ADLXR	VSON	DLX	4	3000	RoHS & Green	Call TI	Call TI	Call TI	Call TI	Call TI	Call TI	Call TI	Call TI
CDC6CE049152 ADLYR	VSON	DLY	4	3000	RoHS & Green	Call TI	Call TI	Call TI	Call TI	Call TI	Call TI	Call TI	Call TI
CDC6CA049152 ADLER	VSON	DLE	4	3000	RoHS & Green	Call TI	Call TI	Call TI	Call TI	Call TI	Call TI	Call TI	Call TI
CDC6CA049152 ADLFR	VSON	DLF	4	3000	RoHS & Green	Call TI	Call TI	Call TI	Call TI	Call TI	Call TI	Call TI	Call TI
CDC6CA049152 ADLXR	VSON	DLX	4	3000	RoHS & Green	Call TI	Call TI	Call TI	Call TI	Call TI	Call TI	Call TI	Call TI
CDC6CA049152 ADLYR	VSON	DLY	4	3000	RoHS & Green	Call TI	Call TI	Call TI	Call TI	Call TI	Call TI	Call TI	Call TI
CDC6CE050000 ADLER	VSON	DLE	4	3000	RoHS & Green	Call TI	Call TI	Call TI	Call TI	Call TI	Call TI	Call TI	Call TI
CDC6CE050000 ADLFR	VSON	DLF	4	3000	RoHS & Green	Call TI	Call TI	Call TI	Call TI	Call TI	Call TI	Call TI	Call TI
CDC6CE050000 ADLXR	VSON	DLX	4	3000	RoHS & Green	Call TI	Call TI	Call TI	Call TI	Call TI	Call TI	Call TI	Call TI
CDC6CE050000 ADLYR	VSON	DLY	4	3000	RoHS & Green	Call TI	Call TI	Call TI	Call TI	Call TI	Call TI	Call TI	Call TI
CDC6CA050000 ADLER	VSON	DLE	4	3000	RoHS & Green	Call TI	Call TI	Call TI	Call TI	Call TI	Call TI	Call TI	Call TI

CDC6C

SNAS843C – DECEMBER 2024 – REVISED JULY 2025

Device	Package Type	Package Drawing	Pins	SPQ	Eco Plan	Reel Diameter (mm)	Reel Width W1 (mm)	A0 (mm)	B0 (mm)	K0 (mm)	P1 (mm)	W (mm)	Pin1 Quadrant
CDC6CA050000 ADLFR	VSON	DLF	4	3000	RoHS & Green	Call TI	Call TI	Call TI	Call TI	Call TI	Call TI	Call TI	Call TI
CDC6CA050000 ADLXR	VSON	DLX	4	3000	RoHS & Green	Call TI	Call TI	Call TI	Call TI	Call TI	Call TI	Call TI	Call TI
CDC6CA050000 ADLYR	VSON	DLY	4	3000	RoHS & Green	Call TI	Call TI	Call TI	Call TI	Call TI	Call TI	Call TI	Call TI
CDC6CE066666 ADLER	VSON	DLE	4	3000	RoHS & Green	Call TI	Call TI	Call TI	Call TI	Call TI	Call TI	Call TI	Call TI
CDC6CE066666 ADLFR	VSON	DLF	4	3000	RoHS & Green	Call TI	Call TI	Call TI	Call TI	Call TI	Call TI	Call TI	Call TI
CDC6CE066666 ADLXR	VSON	DLX	4	3000	RoHS & Green	Call TI	Call TI	Call TI	Call TI	Call TI	Call TI	Call TI	Call TI
CDC6CE066666 ADLYR	VSON	DLY	4	3000	RoHS & Green	Call TI	Call TI	Call TI	Call TI	Call TI	Call TI	Call TI	Call TI
CDC6CA066666 ADLER	VSON	DLE	4	3000	RoHS & Green	Call TI	Call TI	Call TI	Call TI	Call TI	Call TI	Call TI	Call TI
CDC6CA066666 ADLFR	VSON	DLF	4	3000	RoHS & Green	Call TI	Call TI	Call TI	Call TI	Call TI	Call TI	Call TI	Call TI
CDC6CA066666 ADLXR	VSON	DLX	4	3000	RoHS & Green	Call TI	Call TI	Call TI	Call TI	Call TI	Call TI	Call TI	Call TI
CDC6CA066666 ADLYR	VSON	DLY	4	3000	RoHS & Green	Call TI	Call TI	Call TI	Call TI	Call TI	Call TI	Call TI	Call TI
CDC6CE076800 ADLER	VSON	DLE	4	3000	RoHS & Green	Call TI	Call TI	Call TI	Call TI	Call TI	Call TI	Call TI	Call TI
CDC6CE076800 ADLFR	VSON	DLF	4	3000	RoHS & Green	Call TI	Call TI	Call TI	Call TI	Call TI	Call TI	Call TI	Call TI
CDC6CE076800 ADLXR	VSON	DLX	4	3000	RoHS & Green	Call TI	Call TI	Call TI	Call TI	Call TI	Call TI	Call TI	Call TI
CDC6CE076800 ADLYR	VSON	DLY	4	3000	RoHS & Green	Call TI	Call TI	Call TI	Call TI	Call TI	Call TI	Call TI	Call TI
CDC6CA076800 ADLER	VSON	DLE	4	3000	RoHS & Green	Call TI	Call TI	Call TI	Call TI	Call TI	Call TI	Call TI	Call TI
CDC6CA076800 ADLFR	VSON	DLF	4	3000	RoHS & Green	Call TI	Call TI	Call TI	Call TI	Call TI	Call TI	Call TI	Call TI
CDC6CA076800 ADLXR	VSON	DLX	4	3000	RoHS & Green	Call TI	Call TI	Call TI	Call TI	Call TI	Call TI	Call TI	Call TI
CDC6CA076800 ADLYR	VSON	DLY	4	3000	RoHS & Green	Call TI	Call TI	Call TI	Call TI	Call TI	Call TI	Call TI	Call TI
CDC6CE100000 ADLER	VSON	DLE	4	3000	RoHS & Green	Call TI	Call TI	Call TI	Call TI	Call TI	Call TI	Call TI	Call TI
CDC6CE100000 ADLFR	VSON	DLF	4	3000	RoHS & Green	Call TI	Call TI	Call TI	Call TI	Call TI	Call TI	Call TI	Call TI
CDC6CE100000 ADLXR	VSON	DLX	4	3000	RoHS & Green	Call TI	Call TI	Call TI	Call TI	Call TI	Call TI	Call TI	Call TI
CDC6CE100000 ADLYR	VSON	DLY	4	3000	RoHS & Green	Call TI	Call TI	Call TI	Call TI	Call TI	Call TI	Call TI	Call TI
CDC6CA100000 ADLER	VSON	DLE	4	3000	RoHS & Green	Call TI	Call TI	Call TI	Call TI	Call TI	Call TI	Call TI	Call TI
CDC6CA100000 ADLFR	VSON	DLF	4	3000	RoHS & Green	Call TI	Call TI	Call TI	Call TI	Call TI	Call TI	Call TI	Call TI
CDC6CA100000 ADLXR	VSON	DLX	4	3000	RoHS & Green	Call TI	Call TI	Call TI	Call TI	Call TI	Call TI	Call TI	Call TI
CDC6CA100000 ADLYR	VSON	DLY	4	3000	RoHS & Green	Call TI	Call TI	Call TI	Call TI	Call TI	Call TI	Call TI	Call TI
CDC6CE125000 ADLER	VSON	DLE	4	3000	RoHS & Green	Call TI	Call TI	Call TI	Call TI	Call TI	Call TI	Call TI	Call TI
CDC6CE125000 ADLFR	VSON	DLF	4	3000	RoHS & Green	Call TI	Call TI	Call TI	Call TI	Call TI	Call TI	Call TI	Call TI
CDC6CE125000 ADLXR	VSON	DLX	4	3000	RoHS & Green	Call TI	Call TI	Call TI	Call TI	Call TI	Call TI	Call TI	Call TI
CDC6CE125000 ADLYR	VSON	DLY	4	3000	RoHS & Green	Call TI	Call TI	Call TI	Call TI	Call TI	Call TI	Call TI	Call TI
CDC6CA125000 ADLER	VSON	DLE	4	3000	RoHS & Green	Call TI	Call TI	Call TI	Call TI	Call TI	Call TI	Call TI	Call TI
CDC6CA125000 ADLFR	VSON	DLF	4	3000	RoHS & Green	Call TI	Call TI	Call TI	Call TI	Call TI	Call TI	Call TI	Call TI

Device	Package Type	Package Drawing	Pins	SPQ	Eco Plan	Reel Diameter (mm)	Reel Width W1 (mm)	A0 (mm)	B0 (mm)	K0 (mm)	P1 (mm)	W (mm)	Pin1 Quadrant
CDC6CA125000ADLXR	VSON	DLX	4	3000	RoHS & Green	Call TI	Call TI	Call TI	Call TI	Call TI	Call TI	Call TI	Call TI
CDC6CA125000ADLYR	VSON	DLY	4	3000	RoHS & Green	Call TI	Call TI	Call TI	Call TI	Call TI	Call TI	Call TI	Call TI
CDC6CE156250ADLER	VSON	DLE	4	3000	RoHS & Green	Call TI	Call TI	Call TI	Call TI	Call TI	Call TI	Call TI	Call TI
CDC6CE156250ADLFR	VSON	DLF	4	3000	RoHS & Green	Call TI	Call TI	Call TI	Call TI	Call TI	Call TI	Call TI	Call TI
CDC6CE156250ADLXR	VSON	DLX	4	3000	RoHS & Green	Call TI	Call TI	Call TI	Call TI	Call TI	Call TI	Call TI	Call TI
CDC6CE156250ADLYR	VSON	DLY	4	3000	RoHS & Green	Call TI	Call TI	Call TI	Call TI	Call TI	Call TI	Call TI	Call TI
CDC6CA156250ADLER	VSON	DLE	4	3000	RoHS & Green	Call TI	Call TI	Call TI	Call TI	Call TI	Call TI	Call TI	Call TI
CDC6CA156250ADLFR	VSON	DLF	4	3000	RoHS & Green	Call TI	Call TI	Call TI	Call TI	Call TI	Call TI	Call TI	Call TI
CDC6CA156250ADLXR	VSON	DLX	4	3000	RoHS & Green	Call TI	Call TI	Call TI	Call TI	Call TI	Call TI	Call TI	Call TI
CDC6CA156250ADLYR	VSON	DLY	4	3000	RoHS & Green	Call TI	Call TI	Call TI	Call TI	Call TI	Call TI	Call TI	Call TI

TAPE AND REEL BOX DIMENSIONS

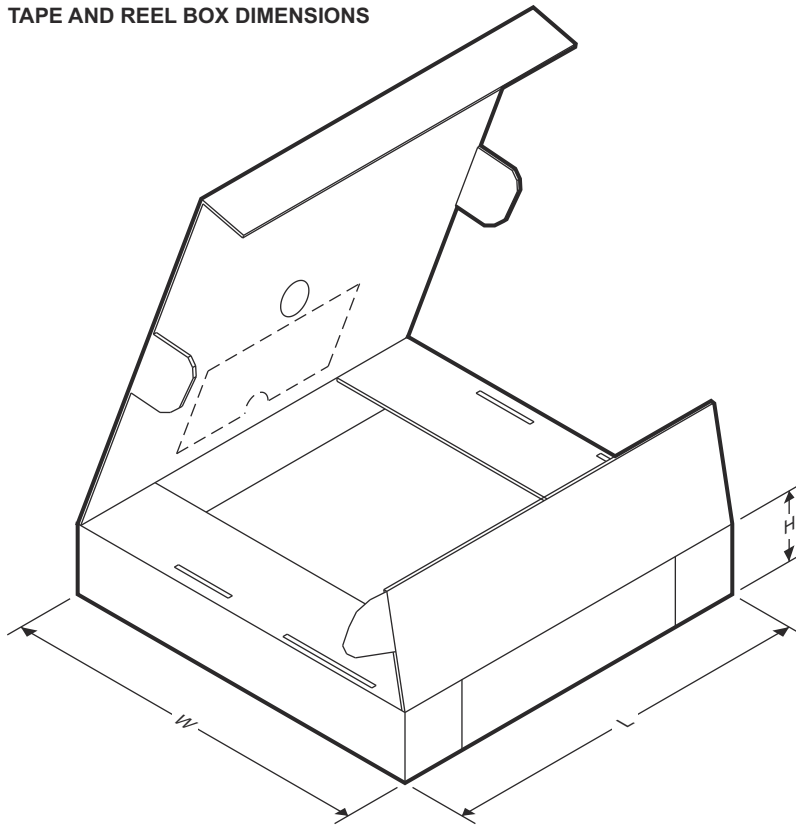

Device	Package Type	Package Drawing	Pins	SPQ	Length (mm)	Width (mm)	Height (mm)
CDC6CE156250CDLFR	VSON	DLF	4	3000	Call TI	Call TI	Call TI
CDC6CE156250DDLFT	VSON	DLF	4	3000	Call TI	Call TI	Call TI
CDC6CE002048ADLER	VSON	DLE	4	3000	Call TI	Call TI	Call TI
CDC6CE002048ADLFR	VSON	DLF	4	3000	Call TI	Call TI	Call TI
CDC6CE002048ADLXR	VSON	DLX	4	3000	Call TI	Call TI	Call TI
CDC6CE002048ADLYR	VSON	DLY	4	3000	Call TI	Call TI	Call TI
CDC6CA002048ADLER	VSON	DLE	4	3000	Call TI	Call TI	Call TI
CDC6CA002048ADLFR	VSON	DLF	4	3000	Call TI	Call TI	Call TI

Device	Package Type	Package Drawing	Pins	SPQ	Length (mm)	Width (mm)	Height (mm)
CDC6CA002048ADLXR	VSON	DLX	4	3000	Call TI	Call TI	Call TI
CDC6CA002048ADLYR	VSON	DLY	4	3000	Call TI	Call TI	Call TI
CDC6CE004000ADLER	VSON	DLE	4	3000	Call TI	Call TI	Call TI
CDC6CE004000ADLFR	VSON	DLF	4	3000	Call TI	Call TI	Call TI
CDC6CE004000ADLXR	VSON	DLX	4	3000	Call TI	Call TI	Call TI
CDC6CE004000ADLYR	VSON	DLY	4	3000	Call TI	Call TI	Call TI
CDC6CA004000ADLER	VSON	DLE	4	3000	Call TI	Call TI	Call TI
CDC6CA004000ADLFR	VSON	DLF	4	3000	Call TI	Call TI	Call TI
CDC6CA004000ADLXR	VSON	DLX	4	3000	Call TI	Call TI	Call TI
CDC6CA004000ADLYR	VSON	DLY	4	3000	Call TI	Call TI	Call TI
CDC6CE005120ADLER	VSON	DLE	4	3000	Call TI	Call TI	Call TI
CDC6CE005120ADLFR	VSON	DLF	4	3000	Call TI	Call TI	Call TI
CDC6CE005120ADLXR	VSON	DLX	4	3000	Call TI	Call TI	Call TI
CDC6CE005120ADLYR	VSON	DLY	4	3000	Call TI	Call TI	Call TI
CDC6CA005120ADLER	VSON	DLE	4	3000	Call TI	Call TI	Call TI
CDC6CA005120ADLFR	VSON	DLF	4	3000	Call TI	Call TI	Call TI
CDC6CA005120ADLXR	VSON	DLX	4	3000	Call TI	Call TI	Call TI
CDC6CA005120ADLYR	VSON	DLY	4	3000	Call TI	Call TI	Call TI
CDC6CE008000ADLER	VSON	DLE	4	3000	Call TI	Call TI	Call TI
CDC6CE008000ADLFR	VSON	DLF	4	3000	Call TI	Call TI	Call TI
CDC6CE008000ADLXR	VSON	DLX	4	3000	Call TI	Call TI	Call TI
CDC6CE008000ADLYR	VSON	DLY	4	3000	Call TI	Call TI	Call TI
CDC6CA008000ADLER	VSON	DLE	4	3000	Call TI	Call TI	Call TI
CDC6CA008000ADLFR	VSON	DLF	4	3000	Call TI	Call TI	Call TI
CDC6CA008000ADLXR	VSON	DLX	4	3000	Call TI	Call TI	Call TI
CDC6CA008000ADLYR	VSON	DLY	4	3000	Call TI	Call TI	Call TI
CDC6CE010000ADLER	VSON	DLE	4	3000	Call TI	Call TI	Call TI
CDC6CE010000ADLFR	VSON	DLF	4	3000	Call TI	Call TI	Call TI
CDC6CE010000ADLXR	VSON	DLX	4	3000	Call TI	Call TI	Call TI
CDC6CE010000ADLYR	VSON	DLY	4	3000	Call TI	Call TI	Call TI
CDC6CA010000ADLER	VSON	DLE	4	3000	Call TI	Call TI	Call TI
CDC6CA010000ADLFR	VSON	DLF	4	3000	Call TI	Call TI	Call TI
CDC6CA010000ADLXR	VSON	DLX	4	3000	Call TI	Call TI	Call TI
CDC6CA010000ADLYR	VSON	DLY	4	3000	Call TI	Call TI	Call TI
CDC6CE012000ADLER	VSON	DLE	4	3000	Call TI	Call TI	Call TI
CDC6CE012000ADLFR	VSON	DLF	4	3000	Call TI	Call TI	Call TI
CDC6CE012000ADLXR	VSON	DLX	4	3000	Call TI	Call TI	Call TI
CDC6CE012000ADLYR	VSON	DLY	4	3000	Call TI	Call TI	Call TI
CDC6CA012000ADLER	VSON	DLE	4	3000	Call TI	Call TI	Call TI
CDC6CA012000ADLFR	VSON	DLF	4	3000	Call TI	Call TI	Call TI
CDC6CA012000ADLXR	VSON	DLX	4	3000	Call TI	Call TI	Call TI
CDC6CA012000ADLYR	VSON	DLY	4	3000	Call TI	Call TI	Call TI
CDC6CE012288ADLER	VSON	DLE	4	3000	Call TI	Call TI	Call TI
CDC6CE012288ADLFR	VSON	DLF	4	3000	Call TI	Call TI	Call TI
CDC6CE012288ADLXR	VSON	DLX	4	3000	Call TI	Call TI	Call TI
CDC6CE012288ADLYR	VSON	DLY	4	3000	Call TI	Call TI	Call TI

Device	Package Type	Package Drawing	Pins	SPQ	Length (mm)	Width (mm)	Height (mm)
CDC6CA012288ADLER	VSON	DLE	4	3000	Call TI	Call TI	Call TI
CDC6CA012288ADLFR	VSON	DLF	4	3000	Call TI	Call TI	Call TI
CDC6CA012288ADLXR	VSON	DLX	4	3000	Call TI	Call TI	Call TI
CDC6CA012288ADLYR	VSON	DLY	4	3000	Call TI	Call TI	Call TI
CDC6CE016000ADLER	VSON	DLE	4	3000	Call TI	Call TI	Call TI
CDC6CE016000ADLFR	VSON	DLF	4	3000	Call TI	Call TI	Call TI
CDC6CE016000ADLXR	VSON	DLX	4	3000	Call TI	Call TI	Call TI
CDC6CE016000ADLYR	VSON	DLY	4	3000	Call TI	Call TI	Call TI
CDC6CA016000ADLER	VSON	DLE	4	3000	Call TI	Call TI	Call TI
CDC6CA016000ADLFR	VSON	DLF	4	3000	Call TI	Call TI	Call TI
CDC6CA016000ADLXR	VSON	DLX	4	3000	Call TI	Call TI	Call TI
CDC6CA016000ADLYR	VSON	DLY	4	3000	Call TI	Call TI	Call TI
CDC6CE019200ADLER	VSON	DLE	4	3000	Call TI	Call TI	Call TI
CDC6CE019200ADLFR	VSON	DLF	4	3000	Call TI	Call TI	Call TI
CDC6CE019200ADLXR	VSON	DLX	4	3000	Call TI	Call TI	Call TI
CDC6CE019200ADLYR	VSON	DLY	4	3000	Call TI	Call TI	Call TI
CDC6CA019200ADLER	VSON	DLE	4	3000	Call TI	Call TI	Call TI
CDC6CA019200ADLFR	VSON	DLF	4	3000	Call TI	Call TI	Call TI
CDC6CA019200ADLXR	VSON	DLX	4	3000	Call TI	Call TI	Call TI
CDC6CA019200ADLYR	VSON	DLY	4	3000	Call TI	Call TI	Call TI
CDC6CE020000ADLER	VSON	DLE	4	3000	Call TI	Call TI	Call TI
CDC6CE020000ADLFR	VSON	DLF	4	3000	Call TI	Call TI	Call TI
CDC6CE020000ADLXR	VSON	DLX	4	3000	Call TI	Call TI	Call TI
CDC6CE020000ADLYR	VSON	DLY	4	3000	Call TI	Call TI	Call TI
CDC6CA020000ADLER	VSON	DLE	4	3000	Call TI	Call TI	Call TI
CDC6CA020000ADLFR	VSON	DLF	4	3000	Call TI	Call TI	Call TI
CDC6CA020000ADLXR	VSON	DLX	4	3000	Call TI	Call TI	Call TI
CDC6CA020000ADLYR	VSON	DLY	4	3000	Call TI	Call TI	Call TI
CDC6CE023500ADLER	VSON	DLE	4	3000	Call TI	Call TI	Call TI
CDC6CE023500ADLFR	VSON	DLF	4	3000	Call TI	Call TI	Call TI
CDC6CE023500ADLXR	VSON	DLX	4	3000	Call TI	Call TI	Call TI
CDC6CE023500ADLYR	VSON	DLY	4	3000	Call TI	Call TI	Call TI
CDC6CA023500ADLER	VSON	DLE	4	3000	Call TI	Call TI	Call TI
CDC6CA023500ADLFR	VSON	DLF	4	3000	Call TI	Call TI	Call TI
CDC6CA023500ADLXR	VSON	DLX	4	3000	Call TI	Call TI	Call TI
CDC6CA023500ADLYR	VSON	DLY	4	3000	Call TI	Call TI	Call TI
CDC6CE024000ADLER	VSON	DLE	4	3000	Call TI	Call TI	Call TI
CDC6CE024000ADLFR	VSON	DLF	4	3000	Call TI	Call TI	Call TI
CDC6CE024000ADLXR	VSON	DLX	4	3000	Call TI	Call TI	Call TI
CDC6CE024000ADLYR	VSON	DLY	4	3000	Call TI	Call TI	Call TI
CDC6CA024000ADLER	VSON	DLE	4	3000	Call TI	Call TI	Call TI
CDC6CA024000ADLFR	VSON	DLF	4	3000	Call TI	Call TI	Call TI
CDC6CA024000ADLXR	VSON	DLX	4	3000	Call TI	Call TI	Call TI
CDC6CA024000ADLYR	VSON	DLY	4	3000	Call TI	Call TI	Call TI
CDC6CE024576ADLER	VSON	DLE	4	3000	Call TI	Call TI	Call TI
CDC6CE024576ADLFR	VSON	DLF	4	3000	Call TI	Call TI	Call TI

Device	Package Type	Package Drawing	Pins	SPQ	Length (mm)	Width (mm)	Height (mm)
CDC6CE024576ADLXR	VSON	DLX	4	3000	Call TI	Call TI	Call TI
CDC6CE024576ADLYR	VSON	DLY	4	3000	Call TI	Call TI	Call TI
CDC6CA024576ADLER	VSON	DLE	4	3000	Call TI	Call TI	Call TI
CDC6CA024576ADLFR	VSON	DLF	4	3000	Call TI	Call TI	Call TI
CDC6CA024576ADLXR	VSON	DLX	4	3000	Call TI	Call TI	Call TI
CDC6CA024576ADLYR	VSON	DLY	4	3000	Call TI	Call TI	Call TI
CDC6CE025000ADLER	VSON	DLE	4	3000	Call TI	Call TI	Call TI
CDC6CE025000ADLFR	VSON	DLF	4	3000	Call TI	Call TI	Call TI
CDC6CE025000ADLXR	VSON	DLX	4	3000	Call TI	Call TI	Call TI
CDC6CE025000ADLYR	VSON	DLY	4	3000	Call TI	Call TI	Call TI
CDC6CA025000ADLER	VSON	DLE	4	3000	Call TI	Call TI	Call TI
CDC6CA025000ADLFR	VSON	DLF	4	3000	Call TI	Call TI	Call TI
CDC6CA025000ADLXR	VSON	DLX	4	3000	Call TI	Call TI	Call TI
CDC6CA025000ADLYR	VSON	DLY	4	3000	Call TI	Call TI	Call TI
CDC6CE026000ADLER	VSON	DLE	4	3000	Call TI	Call TI	Call TI
CDC6CE026000ADLFR	VSON	DLF	4	3000	Call TI	Call TI	Call TI
CDC6CE026000ADLXR	VSON	DLX	4	3000	Call TI	Call TI	Call TI
CDC6CE026000ADLYR	VSON	DLY	4	3000	Call TI	Call TI	Call TI
CDC6CA026000ADLER	VSON	DLE	4	3000	Call TI	Call TI	Call TI
CDC6CA026000ADLFR	VSON	DLF	4	3000	Call TI	Call TI	Call TI
CDC6CA026000ADLXR	VSON	DLX	4	3000	Call TI	Call TI	Call TI
CDC6CA026000ADLYR	VSON	DLY	4	3000	Call TI	Call TI	Call TI
CDC6CE026214ADLER	VSON	DLE	4	3000	Call TI	Call TI	Call TI
CDC6CE026214ADLFR	VSON	DLF	4	3000	Call TI	Call TI	Call TI
CDC6CE026214ADLXR	VSON	DLX	4	3000	Call TI	Call TI	Call TI
CDC6CE026214ADLYR	VSON	DLY	4	3000	Call TI	Call TI	Call TI
CDC6CA026214ADLER	VSON	DLE	4	3000	Call TI	Call TI	Call TI
CDC6CA026214ADLFR	VSON	DLF	4	3000	Call TI	Call TI	Call TI
CDC6CA026214ADLXR	VSON	DLX	4	3000	Call TI	Call TI	Call TI
CDC6CA026214ADLYR	VSON	DLY	4	3000	Call TI	Call TI	Call TI
CDC6CE027000ADLER	VSON	DLE	4	3000	Call TI	Call TI	Call TI
CDC6CE027000ADLFR	VSON	DLF	4	3000	Call TI	Call TI	Call TI
CDC6CE027000ADLXR	VSON	DLX	4	3000	Call TI	Call TI	Call TI
CDC6CE027000ADLYR	VSON	DLY	4	3000	Call TI	Call TI	Call TI
CDC6CA027000ADLER	VSON	DLE	4	3000	Call TI	Call TI	Call TI
CDC6CA027000ADLFR	VSON	DLF	4	3000	Call TI	Call TI	Call TI
CDC6CA027000ADLXR	VSON	DLX	4	3000	Call TI	Call TI	Call TI
CDC6CA027000ADLYR	VSON	DLY	4	3000	Call TI	Call TI	Call TI
CDC6CE028125ADLER	VSON	DLE	4	3000	Call TI	Call TI	Call TI
CDC6CE028125ADLFR	VSON	DLF	4	3000	Call TI	Call TI	Call TI
CDC6CE028125ADLXR	VSON	DLX	4	3000	Call TI	Call TI	Call TI
CDC6CE028125ADLYR	VSON	DLY	4	3000	Call TI	Call TI	Call TI
CDC6CA028125ADLER	VSON	DLE	4	3000	Call TI	Call TI	Call TI
CDC6CA028125ADLFR	VSON	DLF	4	3000	Call TI	Call TI	Call TI
CDC6CA028125ADLXR	VSON	DLX	4	3000	Call TI	Call TI	Call TI
CDC6CA028125ADLYR	VSON	DLY	4	3000	Call TI	Call TI	Call TI

Device	Package Type	Package Drawing	Pins	SPQ	Length (mm)	Width (mm)	Height (mm)
CDC6CE029992ADLER	VSON	DLE	4	3000	Call TI	Call TI	Call TI
CDC6CE029992ADLFR	VSON	DLF	4	3000	Call TI	Call TI	Call TI
CDC6CE029992ADLXR	VSON	DLX	4	3000	Call TI	Call TI	Call TI
CDC6CE029992ADLYR	VSON	DLY	4	3000	Call TI	Call TI	Call TI
CDC6CA029992ADLER	VSON	DLE	4	3000	Call TI	Call TI	Call TI
CDC6CA029992ADLFR	VSON	DLF	4	3000	Call TI	Call TI	Call TI
CDC6CA029992ADLXR	VSON	DLX	4	3000	Call TI	Call TI	Call TI
CDC6CA029992ADLYR	VSON	DLY	4	3000	Call TI	Call TI	Call TI
CDC6CE030000ADLER	VSON	DLE	4	3000	Call TI	Call TI	Call TI
CDC6CE030000ADLFR	VSON	DLF	4	3000	Call TI	Call TI	Call TI
CDC6CE030000ADLXR	VSON	DLX	4	3000	Call TI	Call TI	Call TI
CDC6CE030000ADLYR	VSON	DLY	4	3000	Call TI	Call TI	Call TI
CDC6CA030000ADLER	VSON	DLE	4	3000	Call TI	Call TI	Call TI
CDC6CA030000ADLFR	VSON	DLF	4	3000	Call TI	Call TI	Call TI
CDC6CA030000ADLXR	VSON	DLX	4	3000	Call TI	Call TI	Call TI
CDC6CA030000ADLYR	VSON	DLY	4	3000	Call TI	Call TI	Call TI
CDC6CE032768ADLER	VSON	DLE	4	3000	Call TI	Call TI	Call TI
CDC6CE032768ADLFR	VSON	DLF	4	3000	Call TI	Call TI	Call TI
CDC6CE032768ADLXR	VSON	DLX	4	3000	Call TI	Call TI	Call TI
CDC6CE032768ADLYR	VSON	DLY	4	3000	Call TI	Call TI	Call TI
CDC6CA032768ADLER	VSON	DLE	4	3000	Call TI	Call TI	Call TI
CDC6CA032768ADLFR	VSON	DLF	4	3000	Call TI	Call TI	Call TI
CDC6CA032768ADLXR	VSON	DLX	4	3000	Call TI	Call TI	Call TI
CDC6CA032768ADLYR	VSON	DLY	4	3000	Call TI	Call TI	Call TI
CDC6CE033333ADLER	VSON	DLE	4	3000	Call TI	Call TI	Call TI
CDC6CE033333ADLFR	VSON	DLF	4	3000	Call TI	Call TI	Call TI
CDC6CE033333ADLXR	VSON	DLX	4	3000	Call TI	Call TI	Call TI
CDC6CE033333ADLYR	VSON	DLY	4	3000	Call TI	Call TI	Call TI
CDC6CA033333ADLER	VSON	DLE	4	3000	Call TI	Call TI	Call TI
CDC6CA033333ADLFR	VSON	DLF	4	3000	Call TI	Call TI	Call TI
CDC6CA033333ADLXR	VSON	DLX	4	3000	Call TI	Call TI	Call TI
CDC6CA033333ADLYR	VSON	DLY	4	3000	Call TI	Call TI	Call TI
CDC6CE038400ADLER	VSON	DLE	4	3000	Call TI	Call TI	Call TI
CDC6CE038400ADLFR	VSON	DLF	4	3000	Call TI	Call TI	Call TI
CDC6CE038400ADLXR	VSON	DLX	4	3000	Call TI	Call TI	Call TI
CDC6CE038400ADLYR	VSON	DLY	4	3000	Call TI	Call TI	Call TI
CDC6CA038400ADLER	VSON	DLE	4	3000	Call TI	Call TI	Call TI
CDC6CA038400ADLFR	VSON	DLF	4	3000	Call TI	Call TI	Call TI
CDC6CA038400ADLXR	VSON	DLX	4	3000	Call TI	Call TI	Call TI
CDC6CA038400ADLYR	VSON	DLY	4	3000	Call TI	Call TI	Call TI
CDC6CE040000ADLER	VSON	DLE	4	3000	Call TI	Call TI	Call TI
CDC6CE040000ADLFR	VSON	DLF	4	3000	Call TI	Call TI	Call TI
CDC6CE040000ADLXR	VSON	DLX	4	3000	Call TI	Call TI	Call TI
CDC6CE040000ADLYR	VSON	DLY	4	3000	Call TI	Call TI	Call TI
CDC6CA040000ADLER	VSON	DLE	4	3000	Call TI	Call TI	Call TI
CDC6CA040000ADLFR	VSON	DLF	4	3000	Call TI	Call TI	Call TI

Device	Package Type	Package Drawing	Pins	SPQ	Length (mm)	Width (mm)	Height (mm)
CDC6CA040000ADLXR	VSON	DLX	4	3000	Call TI	Call TI	Call TI
CDC6CA040000ADLYR	VSON	DLY	4	3000	Call TI	Call TI	Call TI
CDC6CE048000ADLER	VSON	DLE	4	3000	Call TI	Call TI	Call TI
CDC6CE048000ADLFR	VSON	DLF	4	3000	Call TI	Call TI	Call TI
CDC6CE048000ADLXR	VSON	DLX	4	3000	Call TI	Call TI	Call TI
CDC6CE048000ADLYR	VSON	DLY	4	3000	Call TI	Call TI	Call TI
CDC6CA048000ADLER	VSON	DLE	4	3000	Call TI	Call TI	Call TI
CDC6CA048000ADLFR	VSON	DLF	4	3000	Call TI	Call TI	Call TI
CDC6CA048000ADLXR	VSON	DLX	4	3000	Call TI	Call TI	Call TI
CDC6CA048000ADLYR	VSON	DLY	4	3000	Call TI	Call TI	Call TI
CDC6CE049152ADLER	VSON	DLE	4	3000	Call TI	Call TI	Call TI
CDC6CE049152ADLFR	VSON	DLF	4	3000	Call TI	Call TI	Call TI
CDC6CE049152ADLXR	VSON	DLX	4	3000	Call TI	Call TI	Call TI
CDC6CE049152ADLYR	VSON	DLY	4	3000	Call TI	Call TI	Call TI
CDC6CA049152ADLER	VSON	DLE	4	3000	Call TI	Call TI	Call TI
CDC6CA049152ADLFR	VSON	DLF	4	3000	Call TI	Call TI	Call TI
CDC6CA049152ADLXR	VSON	DLX	4	3000	Call TI	Call TI	Call TI
CDC6CA049152ADLYR	VSON	DLY	4	3000	Call TI	Call TI	Call TI
CDC6CE050000ADLER	VSON	DLE	4	3000	Call TI	Call TI	Call TI
CDC6CE050000ADLFR	VSON	DLF	4	3000	Call TI	Call TI	Call TI
CDC6CE050000ADLXR	VSON	DLX	4	3000	Call TI	Call TI	Call TI
CDC6CE050000ADLYR	VSON	DLY	4	3000	Call TI	Call TI	Call TI
CDC6CA050000ADLER	VSON	DLE	4	3000	Call TI	Call TI	Call TI
CDC6CA050000ADLFR	VSON	DLF	4	3000	Call TI	Call TI	Call TI
CDC6CA050000ADLXR	VSON	DLX	4	3000	Call TI	Call TI	Call TI
CDC6CA050000ADLYR	VSON	DLY	4	3000	Call TI	Call TI	Call TI
CDC6CE066666ADLER	VSON	DLE	4	3000	Call TI	Call TI	Call TI
CDC6CE066666ADLFR	VSON	DLF	4	3000	Call TI	Call TI	Call TI
CDC6CE066666ADLXR	VSON	DLX	4	3000	Call TI	Call TI	Call TI
CDC6CE066666ADLYR	VSON	DLY	4	3000	Call TI	Call TI	Call TI
CDC6CA066666ADLER	VSON	DLE	4	3000	Call TI	Call TI	Call TI
CDC6CA066666ADLFR	VSON	DLF	4	3000	Call TI	Call TI	Call TI
CDC6CA066666ADLXR	VSON	DLX	4	3000	Call TI	Call TI	Call TI
CDC6CA066666ADLYR	VSON	DLY	4	3000	Call TI	Call TI	Call TI
CDC6CE076800ADLER	VSON	DLE	4	3000	Call TI	Call TI	Call TI
CDC6CE076800ADLFR	VSON	DLF	4	3000	Call TI	Call TI	Call TI
CDC6CE076800ADLXR	VSON	DLX	4	3000	Call TI	Call TI	Call TI
CDC6CE076800ADLYR	VSON	DLY	4	3000	Call TI	Call TI	Call TI
CDC6CA076800ADLER	VSON	DLE	4	3000	Call TI	Call TI	Call TI
CDC6CA076800ADLFR	VSON	DLF	4	3000	Call TI	Call TI	Call TI
CDC6CA076800ADLXR	VSON	DLX	4	3000	Call TI	Call TI	Call TI
CDC6CA076800ADLYR	VSON	DLY	4	3000	Call TI	Call TI	Call TI
CDC6CE100000ADLER	VSON	DLE	4	3000	Call TI	Call TI	Call TI
CDC6CE100000ADLFR	VSON	DLF	4	3000	Call TI	Call TI	Call TI
CDC6CE100000ADLXR	VSON	DLX	4	3000	Call TI	Call TI	Call TI
CDC6CE100000ADLYR	VSON	DLY	4	3000	Call TI	Call TI	Call TI

Device	Package Type	Package Drawing	Pins	SPQ	Length (mm)	Width (mm)	Height (mm)
CDC6CA10000ADLER	VSON	DLE	4	3000	Call TI	Call TI	Call TI
CDC6CA10000ADLFR	VSON	DLF	4	3000	Call TI	Call TI	Call TI
CDC6CA10000ADLXR	VSON	DLX	4	3000	Call TI	Call TI	Call TI
CDC6CA10000ADLYR	VSON	DLY	4	3000	Call TI	Call TI	Call TI
CDC6CE125000ADLER	VSON	DLE	4	3000	Call TI	Call TI	Call TI
CDC6CE125000ADLFR	VSON	DLF	4	3000	Call TI	Call TI	Call TI
CDC6CE125000ADLXR	VSON	DLX	4	3000	Call TI	Call TI	Call TI
CDC6CE125000ADLYR	VSON	DLY	4	3000	Call TI	Call TI	Call TI
CDC6CA125000ADLER	VSON	DLE	4	3000	Call TI	Call TI	Call TI
CDC6CA125000ADLFR	VSON	DLF	4	3000	Call TI	Call TI	Call TI
CDC6CA125000ADLXR	VSON	DLX	4	3000	Call TI	Call TI	Call TI
CDC6CA125000ADLYR	VSON	DLY	4	3000	Call TI	Call TI	Call TI
CDC6CE156250ADLER	VSON	DLE	4	3000	Call TI	Call TI	Call TI
CDC6CE156250ADLFR	VSON	DLF	4	3000	Call TI	Call TI	Call TI
CDC6CE156250ADLXR	VSON	DLX	4	3000	Call TI	Call TI	Call TI
CDC6CE156250ADLYR	VSON	DLY	4	3000	Call TI	Call TI	Call TI
CDC6CA156250ADLER	VSON	DLE	4	3000	Call TI	Call TI	Call TI
CDC6CA156250ADLFR	VSON	DLF	4	3000	Call TI	Call TI	Call TI
CDC6CA156250ADLXR	VSON	DLX	4	3000	Call TI	Call TI	Call TI
CDC6CA156250ADLYR	VSON	DLY	4	3000	Call TI	Call TI	Call TI

12.2 Orderable Part Number Decoder

Table 12-1. Orderable Part Number Decoder

Device	Pin 1 Functionality	Output Frequency (MHz)	Rise and Fall Time Option	Package Size	Packaging Method
CDC6CE002048ADLER	Output Enable	2.048	Normal Mode	DLE	Large Reel
CDC6CE002048ADLFR	Output Enable	2.048	Normal Mode	DLF	Large Reel
CDC6CE002048ADLXR	Output Enable	2.048	Normal Mode	DLX	Large Reel
CDC6CE002048ADLYR	Output Enable	2.048	Normal Mode	DLY	Large Reel
CDC6CA002048ADLER	Stand By	2.048	Normal Mode	DLE	Large Reel
CDC6CA002048ADLFR	Stand By	2.048	Normal Mode	DLF	Large Reel
CDC6CA002048ADLXR	Stand By	2.048	Normal Mode	DLX	Large Reel
CDC6CA002048ADLYR	Stand By	2.048	Normal Mode	DLY	Large Reel
CDC6CE004000ADLER	Output Enable	4	Normal Mode	DLE	Large Reel
CDC6CE004000ADLFR	Output Enable	4	Normal Mode	DLF	Large Reel
CDC6CE004000ADLXR	Output Enable	4	Normal Mode	DLX	Large Reel
CDC6CE004000ADLYR	Output Enable	4	Normal Mode	DLY	Large Reel
CDC6CA004000ADLER	Stand By	4	Normal Mode	DLE	Large Reel
CDC6CA004000ADLFR	Stand By	4	Normal Mode	DLF	Large Reel
CDC6CA004000ADLXR	Stand By	4	Normal Mode	DLX	Large Reel
CDC6CA004000ADLYR	Stand By	4	Normal Mode	DLY	Large Reel
CDC6CE005120ADLER	Output Enable	5.12	Normal Mode	DLE	Large Reel
CDC6CE005120ADLFR	Output Enable	5.12	Normal Mode	DLF	Large Reel
CDC6CE005120ADLXR	Output Enable	5.12	Normal Mode	DLX	Large Reel
CDC6CE005120ADLYR	Output Enable	5.12	Normal Mode	DLY	Large Reel
CDC6CA005120ADLER	Stand By	5.12	Normal Mode	DLE	Large Reel

Table 12-1. Orderable Part Number Decoder (continued)

Device	Pin 1 Functionality	Output Frequency (MHz)	Rise and Fall Time Option	Package Size	Packaging Method
CDC6CA005120ADLFR	Stand By	5.12	Normal Mode	DLF	Large Reel
CDC6CA005120ADLXR	Stand By	5.12	Normal Mode	DLX	Large Reel
CDC6CA005120ADLYR	Stand By	5.12	Normal Mode	DLY	Large Reel
CDC6CE008000ADLER	Output Enable	8	Normal Mode	DLE	Large Reel
CDC6CE008000ADLFR	Output Enable	8	Normal Mode	DLF	Large Reel
CDC6CE008000ADLXR	Output Enable	8	Normal Mode	DLX	Large Reel
CDC6CE008000ADLYR	Output Enable	8	Normal Mode	DLY	Large Reel
CDC6CA008000ADLER	Stand By	8	Normal Mode	DLE	Large Reel
CDC6CA008000ADLFR	Stand By	8	Normal Mode	DLF	Large Reel
CDC6CA008000ADLXR	Stand By	8	Normal Mode	DLX	Large Reel
CDC6CA008000ADLYR	Stand By	8	Normal Mode	DLY	Large Reel
CDC6CE010000ADLER	Output Enable	10	Normal Mode	DLE	Large Reel
CDC6CE010000ADLFR	Output Enable	10	Normal Mode	DLF	Large Reel
CDC6CE010000ADLXR	Output Enable	10	Normal Mode	DLX	Large Reel
CDC6CE010000ADLYR	Output Enable	10	Normal Mode	DLY	Large Reel
CDC6CA010000ADLER	Stand By	10	Normal Mode	DLE	Large Reel
CDC6CA010000ADLFR	Stand By	10	Normal Mode	DLF	Large Reel
CDC6CA010000ADLXR	Stand By	10	Normal Mode	DLX	Large Reel
CDC6CA010000ADLYR	Stand By	10	Normal Mode	DLY	Large Reel
CDC6CE012000ADLER	Output Enable	12	Normal Mode	DLE	Large Reel
CDC6CE012000ADLFR	Output Enable	12	Normal Mode	DLF	Large Reel
CDC6CE012000ADLXR	Output Enable	12	Normal Mode	DLX	Large Reel
CDC6CE012000ADLYR	Output Enable	12	Normal Mode	DLY	Large Reel
CDC6CA012000ADLER	Stand By	12	Normal Mode	DLE	Large Reel
CDC6CA012000ADLFR	Stand By	12	Normal Mode	DLF	Large Reel
CDC6CA012000ADLXR	Stand By	12	Normal Mode	DLX	Large Reel
CDC6CA012000ADLYR	Stand By	12	Normal Mode	DLY	Large Reel
CDC6CE012288ADLER	Output Enable	12.288	Normal Mode	DLE	Large Reel
CDC6CE012288ADLFR	Output Enable	12.288	Normal Mode	DLF	Large Reel
CDC6CE012288ADLXR	Output Enable	12.288	Normal Mode	DLX	Large Reel
CDC6CE012288ADLYR	Output Enable	12.288	Normal Mode	DLY	Large Reel
CDC6CA012288ADLER	Stand By	12.288	Normal Mode	DLE	Large Reel
CDC6CA012288ADLFR	Stand By	12.288	Normal Mode	DLF	Large Reel
CDC6CA012288ADLXR	Stand By	12.288	Normal Mode	DLX	Large Reel
CDC6CA012288ADLYR	Stand By	12.288	Normal Mode	DLY	Large Reel
CDC6CE016000ADLER	Output Enable	16	Normal Mode	DLE	Large Reel
CDC6CE016000ADLFR	Output Enable	16	Normal Mode	DLF	Large Reel
CDC6CE016000ADLXR	Output Enable	16	Normal Mode	DLX	Large Reel
CDC6CE016000ADLYR	Output Enable	16	Normal Mode	DLY	Large Reel
CDC6CA016000ADLER	Stand By	16	Normal Mode	DLE	Large Reel
CDC6CA016000ADLFR	Stand By	16	Normal Mode	DLF	Large Reel
CDC6CA016000ADLXR	Stand By	16	Normal Mode	DLX	Large Reel
CDC6CA016000ADLYR	Stand By	16	Normal Mode	DLY	Large Reel
CDC6CE019200ADLER	Output Enable	19.2	Normal Mode	DLE	Large Reel

Table 12-1. Orderable Part Number Decoder (continued)

Device	Pin 1 Functionality	Output Frequency (MHz)	Rise and Fall Time Option	Package Size	Packaging Method
CDC6CE019200ADLFR	Output Enable	19.2	Normal Mode	DLF	Large Reel
CDC6CE019200ADLXR	Output Enable	19.2	Normal Mode	DLX	Large Reel
CDC6CE019200ADLYR	Output Enable	19.2	Normal Mode	DLY	Large Reel
CDC6CA019200ADLER	Stand By	19.2	Normal Mode	DLE	Large Reel
CDC6CA019200ADLFR	Stand By	19.2	Normal Mode	DLF	Large Reel
CDC6CA019200ADLXR	Stand By	19.2	Normal Mode	DLX	Large Reel
CDC6CA019200ADLYR	Stand By	19.2	Normal Mode	DLY	Large Reel
CDC6CE020000ADLER	Output Enable	20	Normal Mode	DLE	Large Reel
CDC6CE020000ADLFR	Output Enable	20	Normal Mode	DLF	Large Reel
CDC6CE020000ADLXR	Output Enable	20	Normal Mode	DLX	Large Reel
CDC6CE020000ADLYR	Output Enable	20	Normal Mode	DLY	Large Reel
CDC6CA020000ADLER	Stand By	20	Normal Mode	DLE	Large Reel
CDC6CA020000ADLFR	Stand By	20	Normal Mode	DLF	Large Reel
CDC6CA020000ADLXR	Stand By	20	Normal Mode	DLX	Large Reel
CDC6CA020000ADLYR	Stand By	20	Normal Mode	DLY	Large Reel
CDC6CE023500ADLER	Output Enable	23.5008	Normal Mode	DLE	Large Reel
CDC6CE023500ADLFR	Output Enable	23.5008	Normal Mode	DLF	Large Reel
CDC6CE023500ADLXR	Output Enable	23.5008	Normal Mode	DLX	Large Reel
CDC6CE023500ADLYR	Output Enable	23.5008	Normal Mode	DLY	Large Reel
CDC6CA023500ADLER	Stand By	23.5008	Normal Mode	DLE	Large Reel
CDC6CA023500ADLFR	Stand By	23.5008	Normal Mode	DLF	Large Reel
CDC6CA023500ADLXR	Stand By	23.5008	Normal Mode	DLX	Large Reel
CDC6CA023500ADLYR	Stand By	23.5008	Normal Mode	DLY	Large Reel
CDC6CE024000ADLER	Output Enable	24	Normal Mode	DLE	Large Reel
CDC6CE024000ADLFR	Output Enable	24	Normal Mode	DLF	Large Reel
CDC6CE024000ADLXR	Output Enable	24	Normal Mode	DLX	Large Reel
CDC6CE024000ADLYR	Output Enable	24	Normal Mode	DLY	Large Reel
CDC6CA024000ADLER	Stand By	24	Normal Mode	DLE	Large Reel
CDC6CA024000ADLFR	Stand By	24	Normal Mode	DLF	Large Reel
CDC6CA024000ADLXR	Stand By	24	Normal Mode	DLX	Large Reel
CDC6CA024000ADLYR	Stand By	24	Normal Mode	DLY	Large Reel
CDC6CE024576ADLER	Output Enable	24.576	Normal Mode	DLE	Large Reel
CDC6CE024576ADLFR	Output Enable	24.576	Normal Mode	DLF	Large Reel
CDC6CE024576ADLXR	Output Enable	24.576	Normal Mode	DLX	Large Reel
CDC6CE024576ADLYR	Output Enable	24.576	Normal Mode	DLY	Large Reel
CDC6CA024576ADLER	Stand By	24.576	Normal Mode	DLE	Large Reel
CDC6CA024576ADLFR	Stand By	24.576	Normal Mode	DLF	Large Reel
CDC6CA024576ADLXR	Stand By	24.576	Normal Mode	DLX	Large Reel
CDC6CA024576ADLYR	Stand By	24.576	Normal Mode	DLY	Large Reel
CDC6CE025000ADLER	Output Enable	25	Normal Mode	DLE	Large Reel
CDC6CE025000ADLFR	Output Enable	25	Normal Mode	DLF	Large Reel
CDC6CE025000ADLXR	Output Enable	25	Normal Mode	DLX	Large Reel
CDC6CE025000ADLYR	Output Enable	25	Normal Mode	DLY	Large Reel
CDC6CA025000ADLER	Stand By	25	Normal Mode	DLE	Large Reel

Table 12-1. Orderable Part Number Decoder (continued)

Device	Pin 1 Functionality	Output Frequency (MHz)	Rise and Fall Time Option	Package Size	Packaging Method
CDC6CA025000ADLFR	Stand By	25	Normal Mode	DLF	Large Reel
CDC6CA025000ADLXR	Stand By	25	Normal Mode	DLX	Large Reel
CDC6CA025000EDLXR	Stand By	25	Slow mode 4	DLX	Large Reel
CDC6CA025000ADLYR	Stand By	25	Normal Mode	DLY	Large Reel
CDC6CE026000ADLER	Output Enable	26	Normal Mode	DLE	Large Reel
CDC6CE026000ADLFR	Output Enable	26	Normal Mode	DLF	Large Reel
CDC6CE026000ADLXR	Output Enable	26	Normal Mode	DLX	Large Reel
CDC6CE026000ADLYR	Output Enable	26	Normal Mode	DLY	Large Reel
CDC6CA026000ADLER	Stand By	26	Normal Mode	DLE	Large Reel
CDC6CA026000ADLFR	Stand By	26	Normal Mode	DLF	Large Reel
CDC6CA026000ADLXR	Stand By	26	Normal Mode	DLX	Large Reel
CDC6CA026000ADLYR	Stand By	26	Normal Mode	DLY	Large Reel
CDC6CE026214ADLER	Output Enable	26.2144	Normal Mode	DLE	Large Reel
CDC6CE026214ADLFR	Output Enable	26.2144	Normal Mode	DLF	Large Reel
CDC6CE026214ADLXR	Output Enable	26.2144	Normal Mode	DLX	Large Reel
CDC6CE026214ADLYR	Output Enable	26.2144	Normal Mode	DLY	Large Reel
CDC6CA026214ADLER	Stand By	26.2144	Normal Mode	DLE	Large Reel
CDC6CA026214ADLFR	Stand By	26.2144	Normal Mode	DLF	Large Reel
CDC6CA026214ADLXR	Stand By	26.2144	Normal Mode	DLX	Large Reel
CDC6CA026214ADLYR	Stand By	26.2144	Normal Mode	DLY	Large Reel
CDC6CE027000ADLER	Output Enable	27	Normal Mode	DLE	Large Reel
CDC6CE027000ADLFR	Output Enable	27	Normal Mode	DLF	Large Reel
CDC6CE027000ADLXR	Output Enable	27	Normal Mode	DLX	Large Reel
CDC6CE027000ADLYR	Output Enable	27	Normal Mode	DLY	Large Reel
CDC6CA027000ADLER	Stand By	27	Normal Mode	DLE	Large Reel
CDC6CA027000ADLFR	Stand By	27	Normal Mode	DLF	Large Reel
CDC6CA027000ADLXR	Stand By	27	Normal Mode	DLX	Large Reel
CDC6CA027000ADLYR	Stand By	27	Normal Mode	DLY	Large Reel
CDC6CE028125ADLER	Output Enable	28.125	Normal Mode	DLE	Large Reel
CDC6CE028125ADLFR	Output Enable	28.125	Normal Mode	DLF	Large Reel
CDC6CE028125ADLXR	Output Enable	28.125	Normal Mode	DLX	Large Reel
CDC6CE028125ADLYR	Output Enable	28.125	Normal Mode	DLY	Large Reel
CDC6CA028125ADLER	Stand By	28.125	Normal Mode	DLE	Large Reel
CDC6CA028125ADLFR	Stand By	28.125	Normal Mode	DLF	Large Reel
CDC6CA028125ADLXR	Stand By	28.125	Normal Mode	DLX	Large Reel
CDC6CA028125ADLYR	Stand By	28.125	Normal Mode	DLY	Large Reel
CDC6CE029992ADLER	Output Enable	29.9925	Normal Mode	DLE	Large Reel
CDC6CE029992ADLFR	Output Enable	29.9925	Normal Mode	DLF	Large Reel
CDC6CE029992ADLXR	Output Enable	29.9925	Normal Mode	DLX	Large Reel
CDC6CE029992ADLYR	Output Enable	29.9925	Normal Mode	DLY	Large Reel
CDC6CA029992ADLER	Stand By	29.9925	Normal Mode	DLE	Large Reel
CDC6CA029992ADLFR	Stand By	29.9925	Normal Mode	DLF	Large Reel
CDC6CA029992ADLXR	Stand By	29.9925	Normal Mode	DLX	Large Reel
CDC6CA029992ADLYR	Stand By	29.9925	Normal Mode	DLY	Large Reel

Table 12-1. Orderable Part Number Decoder (continued)

Device	Pin 1 Functionality	Output Frequency (MHz)	Rise and Fall Time Option	Package Size	Packaging Method
CDC6CE030000ADLER	Output Enable	30	Normal Mode	DLE	Large Reel
CDC6CE030000ADLFR	Output Enable	30	Normal Mode	DLF	Large Reel
CDC6CE030000ADLXR	Output Enable	30	Normal Mode	DLX	Large Reel
CDC6CE030000ADLYR	Output Enable	30	Normal Mode	DLY	Large Reel
CDC6CA030000ADLER	Stand By	30	Normal Mode	DLE	Large Reel
CDC6CA030000ADLFR	Stand By	30	Normal Mode	DLF	Large Reel
CDC6CA030000ADLXR	Stand By	30	Normal Mode	DLX	Large Reel
CDC6CA030000ADLYR	Stand By	30	Normal Mode	DLY	Large Reel
CDC6CE032768ADLER	Output Enable	32.768	Normal Mode	DLE	Large Reel
CDC6CE032768ADLFR	Output Enable	32.768	Normal Mode	DLF	Large Reel
CDC6CE032768ADLXR	Output Enable	32.768	Normal Mode	DLX	Large Reel
CDC6CE032768ADLYR	Output Enable	32.768	Normal Mode	DLY	Large Reel
CDC6CA032768ADLER	Stand By	32.768	Normal Mode	DLE	Large Reel
CDC6CA032768ADLFR	Stand By	32.768	Normal Mode	DLF	Large Reel
CDC6CA032768ADLXR	Stand By	32.768	Normal Mode	DLX	Large Reel
CDC6CA032768ADLYR	Stand By	32.768	Normal Mode	DLY	Large Reel
CDC6CE033333ADLER	Output Enable	33.333	Normal Mode	DLE	Large Reel
CDC6CE033333ADLFR	Output Enable	33.333	Normal Mode	DLF	Large Reel
CDC6CE033333ADLXR	Output Enable	33.333	Normal Mode	DLX	Large Reel
CDC6CE033333ADLYR	Output Enable	33.333	Normal Mode	DLY	Large Reel
CDC6CA033333ADLER	Stand By	33.333	Normal Mode	DLE	Large Reel
CDC6CA033333ADLFR	Stand By	33.333	Normal Mode	DLF	Large Reel
CDC6CA033333ADLXR	Stand By	33.333	Normal Mode	DLX	Large Reel
CDC6CA033333ADLYR	Stand By	33.333	Normal Mode	DLY	Large Reel
CDC6CE038400ADLER	Output Enable	38.4	Normal Mode	DLE	Large Reel
CDC6CE038400ADLFR	Output Enable	38.4	Normal Mode	DLF	Large Reel
CDC6CE038400ADLXR	Output Enable	38.4	Normal Mode	DLX	Large Reel
CDC6CE038400ADLYR	Output Enable	38.4	Normal Mode	DLY	Large Reel
CDC6CA038400ADLER	Stand By	38.4	Normal Mode	DLE	Large Reel
CDC6CA038400ADLFR	Stand By	38.4	Normal Mode	DLF	Large Reel
CDC6CA038400ADLXR	Stand By	38.4	Normal Mode	DLX	Large Reel
CDC6CA038400ADLYR	Stand By	38.4	Normal Mode	DLY	Large Reel
CDC6CE040000ADLER	Output Enable	40	Normal Mode	DLE	Large Reel
CDC6CE040000ADLFR	Output Enable	40	Normal Mode	DLF	Large Reel
CDC6CE040000ADLXR	Output Enable	40	Normal Mode	DLX	Large Reel
CDC6CE040000ADLYR	Output Enable	40	Normal Mode	DLY	Large Reel
CDC6CA040000ADLER	Stand By	40	Normal Mode	DLE	Large Reel
CDC6CA040000ADLFR	Stand By	40	Normal Mode	DLF	Large Reel
CDC6CA040000ADLXR	Stand By	40	Normal Mode	DLX	Large Reel
CDC6CA040000ADLYR	Stand By	40	Normal Mode	DLY	Large Reel
CDC6CE048000ADLER	Output Enable	48	Normal Mode	DLE	Large Reel
CDC6CE048000ADLFR	Output Enable	48	Normal Mode	DLF	Large Reel
CDC6CE048000ADLXR	Output Enable	48	Normal Mode	DLX	Large Reel
CDC6CE048000ADLYR	Output Enable	48	Normal Mode	DLY	Large Reel

Table 12-1. Orderable Part Number Decoder (continued)

Device	Pin 1 Functionality	Output Frequency (MHz)	Rise and Fall Time Option	Package Size	Packaging Method
CDC6CA048000ADLER	Stand By	48	Normal Mode	DLE	Large Reel
CDC6CA048000ADLFR	Stand By	48	Normal Mode	DLF	Large Reel
CDC6CA048000ADLXR	Stand By	48	Normal Mode	DLX	Large Reel
CDC6CA048000ADLYR	Stand By	48	Normal Mode	DLY	Large Reel
CDC6CE049152ADLER	Output Enable	49.152	Normal Mode	DLE	Large Reel
CDC6CE049152ADLFR	Output Enable	49.152	Normal Mode	DLF	Large Reel
CDC6CE049152ADLXR	Output Enable	49.152	Normal Mode	DLX	Large Reel
CDC6CE049152ADLYR	Output Enable	49.152	Normal Mode	DLY	Large Reel
CDC6CA049152ADLER	Stand By	49.152	Normal Mode	DLE	Large Reel
CDC6CA049152ADLFR	Stand By	49.152	Normal Mode	DLF	Large Reel
CDC6CA049152ADLXR	Stand By	49.152	Normal Mode	DLX	Large Reel
CDC6CA049152ADLYR	Stand By	49.152	Normal Mode	DLY	Large Reel
CDC6CE050000ADLER	Output Enable	50	Normal Mode	DLE	Large Reel
CDC6CE050000ADLFR	Output Enable	50	Normal Mode	DLF	Large Reel
CDC6CE050000ADLXR	Output Enable	50	Normal Mode	DLX	Large Reel
CDC6CE050000ADLYR	Output Enable	50	Normal Mode	DLY	Large Reel
CDC6CA050000ADLER	Stand By	50	Normal Mode	DLE	Large Reel
CDC6CA050000ADLFR	Stand By	50	Normal Mode	DLF	Large Reel
CDC6CA050000ADLXR	Stand By	50	Normal Mode	DLX	Large Reel
CDC6CA050000ADLYR	Stand By	50	Normal Mode	DLY	Large Reel
CDC6CE066666ADLER	Output Enable	66.666	Normal Mode	DLE	Large Reel
CDC6CE066666ADLFR	Output Enable	66.666	Normal Mode	DLF	Large Reel
CDC6CE066666ADLXR	Output Enable	66.666	Normal Mode	DLX	Large Reel
CDC6CE066666ADLYR	Output Enable	66.666	Normal Mode	DLY	Large Reel
CDC6CA066666ADLER	Stand By	66.666	Normal Mode	DLE	Large Reel
CDC6CA066666ADLFR	Stand By	66.666	Normal Mode	DLF	Large Reel
CDC6CA066666ADLXR	Stand By	66.666	Normal Mode	DLX	Large Reel
CDC6CA066666ADLYR	Stand By	66.666	Normal Mode	DLY	Large Reel
CDC6CE076800ADLER	Output Enable	76.8	Normal Mode	DLE	Large Reel
CDC6CE076800ADLFR	Output Enable	76.8	Normal Mode	DLF	Large Reel
CDC6CE076800ADLXR	Output Enable	76.8	Normal Mode	DLX	Large Reel
CDC6CE076800ADLYR	Output Enable	76.8	Normal Mode	DLY	Large Reel
CDC6CA076800ADLER	Stand By	76.8	Normal Mode	DLE	Large Reel
CDC6CA076800ADLFR	Stand By	76.8	Normal Mode	DLF	Large Reel
CDC6CA076800ADLXR	Stand By	76.8	Normal Mode	DLX	Large Reel
CDC6CA076800ADLYR	Stand By	76.8	Normal Mode	DLY	Large Reel
CDC6CE100000ADLER	Output Enable	100	Normal Mode	DLE	Large Reel
CDC6CE100000ADLFR	Output Enable	100	Normal Mode	DLF	Large Reel
CDC6CE100000ADLXR	Output Enable	100	Normal Mode	DLX	Large Reel
CDC6CE100000ADLYR	Output Enable	100	Normal Mode	DLY	Large Reel
CDC6CA100000ADLER	Stand By	100	Normal Mode	DLE	Large Reel
CDC6CA100000ADLFR	Stand By	100	Normal Mode	DLF	Large Reel
CDC6CA100000ADLXR	Stand By	100	Normal Mode	DLX	Large Reel
CDC6CA100000ADLYR	Stand By	100	Normal Mode	DLY	Large Reel

Table 12-1. Orderable Part Number Decoder (continued)

Device	Pin 1 Functionality	Output Frequency (MHz)	Rise and Fall Time Option	Package Size	Packaging Method
CDC6CE125000ADLER	Output Enable	125	Normal Mode	DLE	Large Reel
CDC6CE125000ADLFR	Output Enable	125	Normal Mode	DLF	Large Reel
CDC6CE125000ADLXR	Output Enable	125	Normal Mode	DLX	Large Reel
CDC6CE125000ADLYR	Output Enable	125	Normal Mode	DLY	Large Reel
CDC6CA125000ADLER	Stand By	125	Normal Mode	DLE	Large Reel
CDC6CA125000ADLFR	Stand By	125	Normal Mode	DLF	Large Reel
CDC6CA125000ADLXR	Stand By	125	Normal Mode	DLX	Large Reel
CDC6CA125000ADLYR	Stand By	125	Normal Mode	DLY	Large Reel
CDC6CE156250CDLFR	Output Enable	156.25	Slow Mode 2	DLF	Large Reel
CDC6CE156250DDLFT	Output Enable	156.25	Slow Mode 3	DLF	Small Reel
CDC6CE156250ADLER	Output Enable	156.25	Normal Mode	DLE	Large Reel
CDC6CE156250ADLFR	Output Enable	156.25	Normal Mode	DLF	Large Reel
CDC6CE156250ADLXR	Output Enable	156.25	Normal Mode	DLX	Large Reel
CDC6CE156250ADLYR	Output Enable	156.25	Normal Mode	DLY	Large Reel
CDC6CA156250ADLER	Stand By	156.25	Normal Mode	DLE	Large Reel
CDC6CA156250ADLFR	Stand By	156.25	Normal Mode	DLF	Large Reel
CDC6CA156250ADLXR	Stand By	156.25	Normal Mode	DLX	Large Reel
CDC6CA156250ADLYR	Stand By	156.25	Normal Mode	DLY	Large Reel

PACKAGING INFORMATION

Orderable part number	Status (1)	Material type (2)	Package Pins	Package qty Carrier	RoHS (3)	Lead finish/ Ball material (4)	MSL rating/ Peak reflow (5)	Op temp (°C)	Part marking (6)
CDC6CE019200EDLXR	Active	Production	VSON (DLX) 4	3000 LARGE T&R	Yes	Call TI	Level-1-260C-UNLIM	-40 to 105	5A
CDC6CE020000ADLXR	Active	Production	VSON (DLX) 4	3000 LARGE T&R	Yes	Call TI	Level-1-260C-UNLIM	-40 to 105	EA
CDC6CE024000ADLXR	Active	Production	VSON (DLX) 4	3000 LARGE T&R	Yes	Call TI	Level-1-260C-UNLIM	-40 to 105	DA
CDC6CE024000EDLXR	Active	Production	VSON (DLX) 4	3000 LARGE T&R	Yes	Call TI	Level-1-260C-UNLIM	-40 to 105	7A
CDC6CE025000ADLER	Active	Production	VSON (DLE) 4	3000 LARGE T&R	Yes	Call TI	Level-1-260C-UNLIM	-40 to 105	AA
CDC6CE025000ADLER.A	Active	Production	VSON (DLE) 4	3000 LARGE T&R	Yes	Call TI	Level-1-260C-UNLIM	-40 to 105	AA
CDC6CE025000ADLER.B	Active	Production	VSON (DLE) 4	3000 LARGE T&R	Yes	Call TI	Level-1-260C-UNLIM	-40 to 105	AA
CDC6CE025000ADLFR	Active	Production	VSON (DLF) 4	3000 LARGE T&R	Yes	Call TI	Level-1-260C-UNLIM	-40 to 105	AA
CDC6CE025000ADLFR.A	Active	Production	VSON (DLF) 4	3000 LARGE T&R	Yes	Call TI	Level-1-260C-UNLIM	-40 to 105	AA
CDC6CE025000ADLFR.B	Active	Production	VSON (DLF) 4	3000 LARGE T&R	Yes	Call TI	Level-1-260C-UNLIM	-40 to 105	AA
CDC6CE025000ADLXR	Active	Production	VSON (DLX) 4	3000 LARGE T&R	Yes	Call TI	Level-1-260C-UNLIM	-40 to 105	AA
CDC6CE025000ADLYR	Active	Production	VSON (DLY) 4	3000 LARGE T&R	Yes	Call TI	Level-1-260C-UNLIM	-40 to 105	AA
CDC6CE025000ADLYR.A	Active	Production	VSON (DLY) 4	3000 LARGE T&R	Yes	Call TI	Level-1-260C-UNLIM	-40 to 105	AA
CDC6CE025000ADLYR.B	Active	Production	VSON (DLY) 4	3000 LARGE T&R	Yes	Call TI	Level-1-260C-UNLIM	-40 to 105	AA
CDC6CE025000EDLXR	Active	Production	VSON (DLX) 4	3000 LARGE T&R	Yes	Call TI	Level-1-260C-UNLIM	-40 to 105	4A
CDC6CE026000EDLXR	Active	Production	VSON (DLX) 4	3000 LARGE T&R	Yes	Call TI	Level-1-260C-UNLIM	-40 to 105	6A
CDC6CE027000ADLXR	Active	Production	VSON (DLX) 4	3000 LARGE T&R	Yes	Call TI	Level-1-260C-UNLIM	-40 to 105	JA
CDC6CE027000ADLXR.A	Active	Production	VSON (DLX) 4	3000 LARGE T&R	Yes	Call TI	Level-1-260C-UNLIM	-40 to 105	JA
CDC6CE027000ADLXR.B	Active	Production	VSON (DLX) 4	3000 LARGE T&R	Yes	Call TI	Level-1-260C-UNLIM	-40 to 105	JA
CDC6CE033333ADLXR	Active	Production	VSON (DLX) 4	3000 LARGE T&R	Yes	Call TI	Level-1-260C-UNLIM	-40 to 105	HA
CDC6CE040000ADLFR	Active	Production	VSON (DLF) 4	3000 LARGE T&R	Yes	Call TI	Level-1-260C-UNLIM	-40 to 105	GA
CDC6CE040000ADLFR.A	Active	Production	VSON (DLF) 4	3000 LARGE T&R	Yes	Call TI	Level-1-260C-UNLIM	-40 to 105	GA
CDC6CE040000ADLFR.B	Active	Production	VSON (DLF) 4	3000 LARGE T&R	Yes	Call TI	Level-1-260C-UNLIM	-40 to 105	GA
CDC6CE040000ADLXR	Active	Production	VSON (DLX) 4	3000 LARGE T&R	Yes	Call TI	Level-1-260C-UNLIM	-40 to 105	GA
CDC6CE050000ADLXR	Active	Production	VSON (DLX) 4	3000 LARGE T&R	Yes	Call TI	Level-1-260C-UNLIM	-40 to 105	CA
CDC6CE050000EDLXR	Active	Production	VSON (DLX) 4	3000 LARGE T&R	Yes	Call TI	Level-1-260C-UNLIM	-40 to 105	2A
CDC6CE125000ADLXR	Active	Production	VSON (DLX) 4	3000 LARGE T&R	Yes	Call TI	Level-1-260C-UNLIM	-40 to 105	OA

(1) **Status:** For more details on status, see our [product life cycle](#).

- (2) **Material type:** When designated, preproduction parts are prototypes/experimental devices, and are not yet approved or released for full production. Testing and final process, including without limitation quality assurance, reliability performance testing, and/or process qualification, may not yet be complete, and this item is subject to further changes or possible discontinuation. If available for ordering, purchases will be subject to an additional waiver at checkout, and are intended for early internal evaluation purposes only. These items are sold without warranties of any kind.
- (3) **RoHS values:** Yes, No, RoHS Exempt. See the [TI RoHS Statement](#) for additional information and value definition.
- (4) **Lead finish/Ball material:** Parts may have multiple material finish options. Finish options are separated by a vertical ruled line. Lead finish/Ball material values may wrap to two lines if the finish value exceeds the maximum column width.
- (5) **MSL rating/Peak reflow:** The moisture sensitivity level ratings and peak solder (reflow) temperatures. In the event that a part has multiple moisture sensitivity ratings, only the lowest level per JEDEC standards is shown. Refer to the shipping label for the actual reflow temperature that will be used to mount the part to the printed circuit board.
- (6) **Part marking:** There may be an additional marking, which relates to the logo, the lot trace code information, or the environmental category of the part.

Multiple part markings will be inside parentheses. Only one part marking contained in parentheses and separated by a "~" will appear on a part. If a line is indented then it is a continuation of the previous line and the two combined represent the entire part marking for that device.

Important Information and Disclaimer: The information provided on this page represents TI's knowledge and belief as of the date that it is provided. TI bases its knowledge and belief on information provided by third parties, and makes no representation or warranty as to the accuracy of such information. Efforts are underway to better integrate information from third parties. TI has taken and continues to take reasonable steps to provide representative and accurate information but may not have conducted destructive testing or chemical analysis on incoming materials and chemicals. TI and TI suppliers consider certain information to be proprietary, and thus CAS numbers and other limited information may not be available for release.

In no event shall TI's liability arising out of such information exceed the total purchase price of the TI part(s) at issue in this document sold by TI to Customer on an annual basis.

OTHER QUALIFIED VERSIONS OF CDC6C :

- Automotive : [CDC6C-Q1](#)

NOTE: Qualified Version Definitions:

- Automotive - Q100 devices qualified for high-reliability automotive applications targeting zero defects

TAPE AND REEL INFORMATION

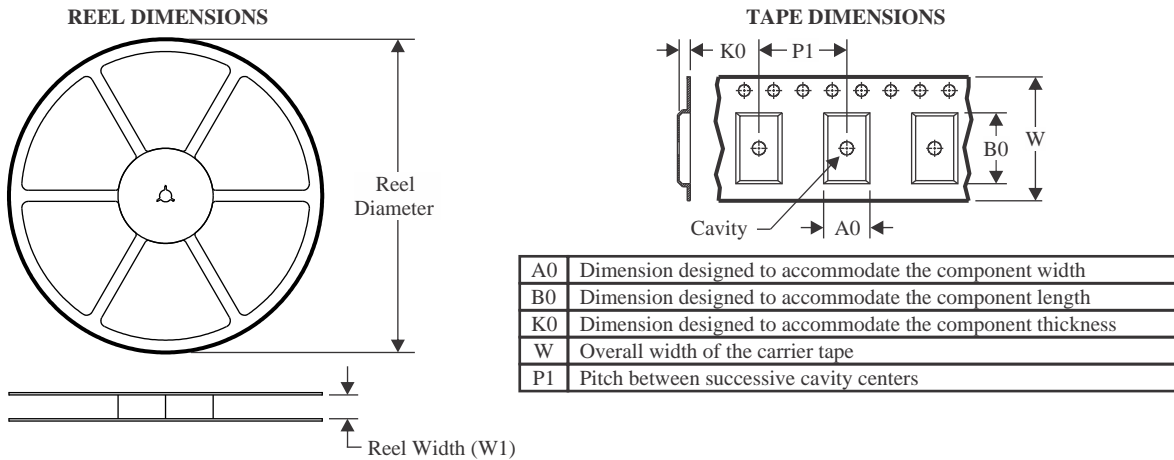

QUADRANT ASSIGNMENTS FOR PIN 1 ORIENTATION IN TAPE

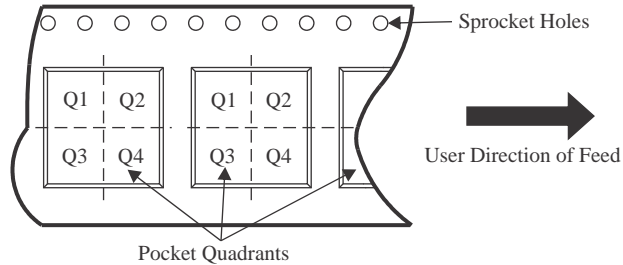

*All dimensions are nominal

Device	Package Type	Package Drawing	Pins	SPQ	Reel Diameter (mm)	Reel Width W1 (mm)	A0 (mm)	B0 (mm)	K0 (mm)	P1 (mm)	W (mm)	Pin1 Quadrant
CDC6CE019200EDLXR	VSON	DLX	4	3000	180.0	8.4	1.85	2.3	1.16	4.0	8.0	Q1
CDC6CE020000ADLXR	VSON	DLX	4	3000	180.0	8.4	1.85	2.3	1.16	4.0	8.0	Q1
CDC6CE024000ADLXR	VSON	DLX	4	3000	180.0	8.4	1.85	2.3	1.16	4.0	8.0	Q1
CDC6CE024000EDLXR	VSON	DLX	4	3000	180.0	8.4	1.85	2.3	1.16	4.0	8.0	Q1
CDC6CE025000ADLER	VSON	DLE	4	3000	330.0	12.4	2.8	3.5	1.2	4.0	12.0	Q1
CDC6CE025000ADLFR	VSON	DLF	4	3000	180.0	8.4	2.25	2.8	1.1	4.0	8.0	Q1
CDC6CE025000ADLXR	VSON	DLX	4	3000	180.0	8.4	1.85	2.3	1.16	4.0	8.0	Q1
CDC6CE025000ADLYR	VSON	DLY	4	3000	180.0	8.4	1.45	1.9	1.07	4.0	8.0	Q1
CDC6CE025000EDLXR	VSON	DLX	4	3000	180.0	8.4	1.85	2.3	1.16	4.0	8.0	Q1
CDC6CE026000EDLXR	VSON	DLX	4	3000	180.0	8.4	1.85	2.3	1.16	4.0	8.0	Q1
CDC6CE027000ADLXR	VSON	DLX	4	3000	180.0	8.4	1.85	2.3	1.16	4.0	8.0	Q1
CDC6CE033333ADLXR	VSON	DLX	4	3000	180.0	8.4	1.85	2.3	1.16	4.0	8.0	Q1
CDC6CE040000ADLFR	VSON	DLF	4	3000	180.0	8.4	2.25	2.8	1.1	4.0	8.0	Q1
CDC6CE040000ADLXR	VSON	DLX	4	3000	180.0	8.4	1.85	2.3	1.16	4.0	8.0	Q1
CDC6CE050000ADLXR	VSON	DLX	4	3000	180.0	8.4	1.85	2.3	1.16	4.0	8.0	Q1
CDC6CE050000EDLXR	VSON	DLX	4	3000	180.0	8.4	1.85	2.3	1.16	4.0	8.0	Q1

Device	Package Type	Package Drawing	Pins	SPQ	Reel Diameter (mm)	Reel Width W1 (mm)	A0 (mm)	B0 (mm)	K0 (mm)	P1 (mm)	W (mm)	Pin1 Quadrant
CDC6CE125000ADLXR	VSON	DLX	4	3000	180.0	8.4	1.85	2.3	1.16	4.0	8.0	Q1

TAPE AND REEL BOX DIMENSIONS

*All dimensions are nominal

Device	Package Type	Package Drawing	Pins	SPQ	Length (mm)	Width (mm)	Height (mm)
CDC6CE019200EDLXR	VSON	DLX	4	3000	182.0	182.0	20.0
CDC6CE020000ADLXR	VSON	DLX	4	3000	182.0	182.0	20.0
CDC6CE024000ADLXR	VSON	DLX	4	3000	182.0	182.0	20.0
CDC6CE024000EDLXR	VSON	DLX	4	3000	182.0	182.0	20.0
CDC6CE025000ADLER	VSON	DLE	4	3000	367.0	367.0	35.0
CDC6CE025000ADLFR	VSON	DLF	4	3000	182.0	182.0	20.0
CDC6CE025000ADLXR	VSON	DLX	4	3000	182.0	182.0	20.0
CDC6CE025000ADLYR	VSON	DLY	4	3000	182.0	182.0	20.0
CDC6CE025000EDLXR	VSON	DLX	4	3000	182.0	182.0	20.0
CDC6CE026000EDLXR	VSON	DLX	4	3000	182.0	182.0	20.0
CDC6CE027000ADLXR	VSON	DLX	4	3000	182.0	182.0	20.0
CDC6CE033333ADLXR	VSON	DLX	4	3000	182.0	182.0	20.0
CDC6CE040000ADLFR	VSON	DLF	4	3000	182.0	182.0	20.0
CDC6CE040000ADLXR	VSON	DLX	4	3000	182.0	182.0	20.0
CDC6CE050000ADLXR	VSON	DLX	4	3000	182.0	182.0	20.0
CDC6CE050000EDLXR	VSON	DLX	4	3000	182.0	182.0	20.0
CDC6CE125000ADLXR	VSON	DLX	4	3000	182.0	182.0	20.0

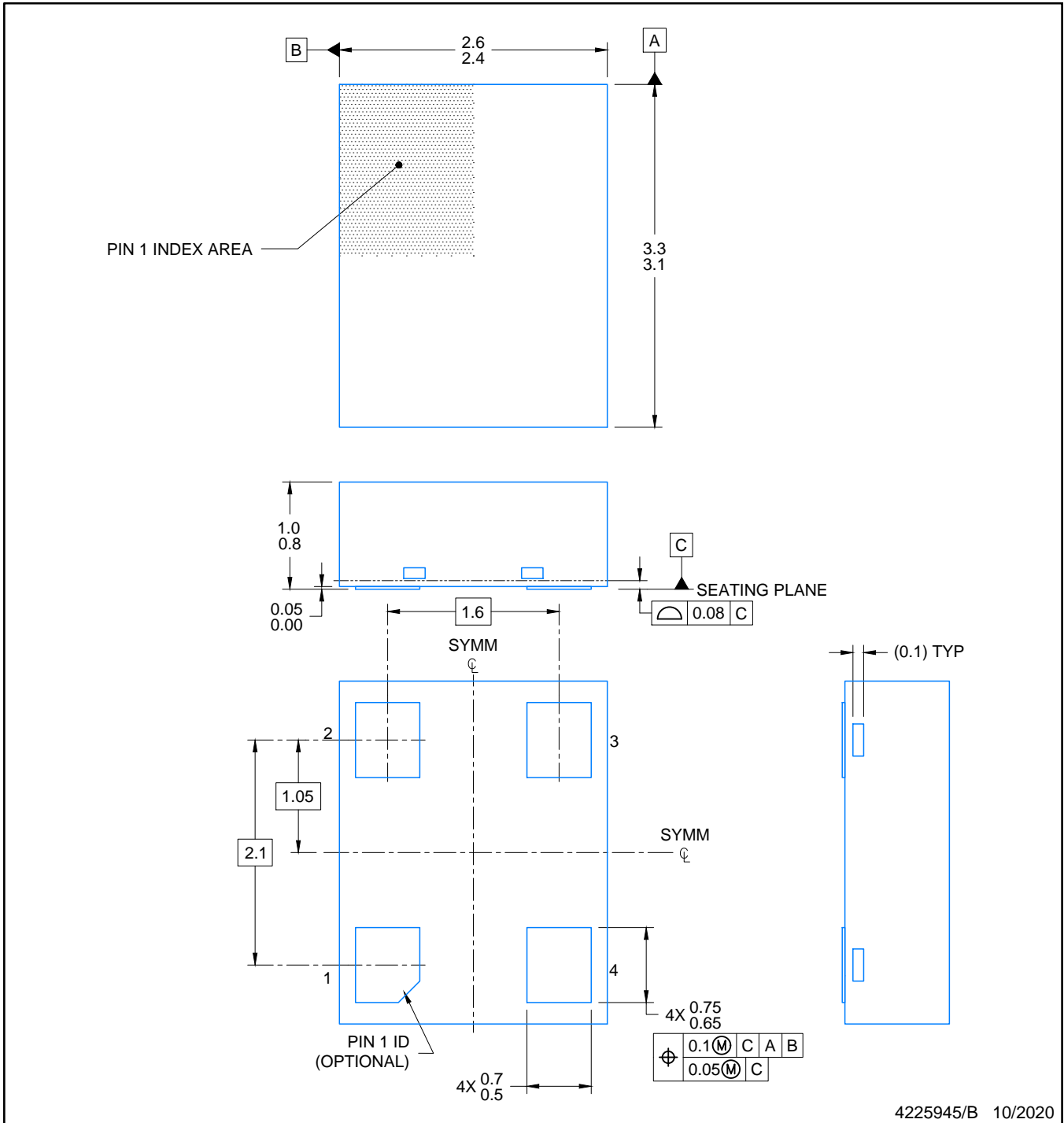

NOTES:

1. All linear dimensions are in millimeters. Any dimensions in parenthesis are for reference only. Dimensioning and tolerancing per ASME Y14.5M.
2. This drawing is subject to change without notice.

EXAMPLE BOARD LAYOUT

DLE0004A

VSON - 1 mm max height

PLASTIC QUAD FLAT PACK-NO LEAD

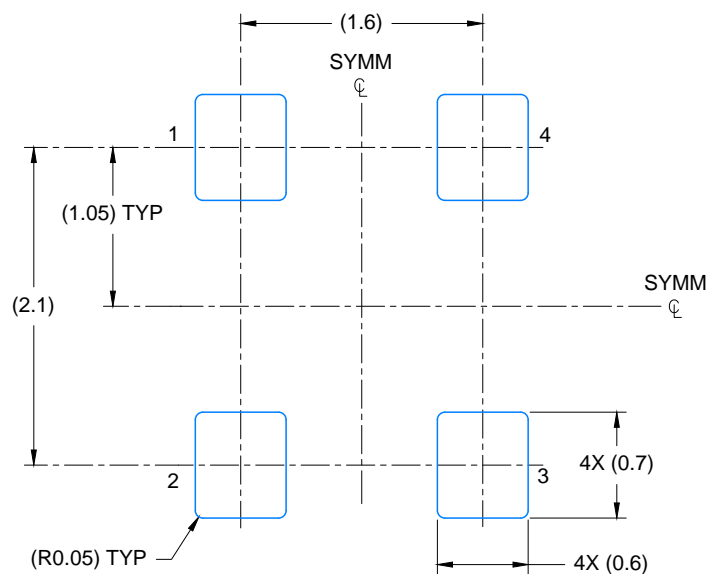

LAND PATTERN EXAMPLE
EXPOSED METAL SHOWN
SCALE: 20X

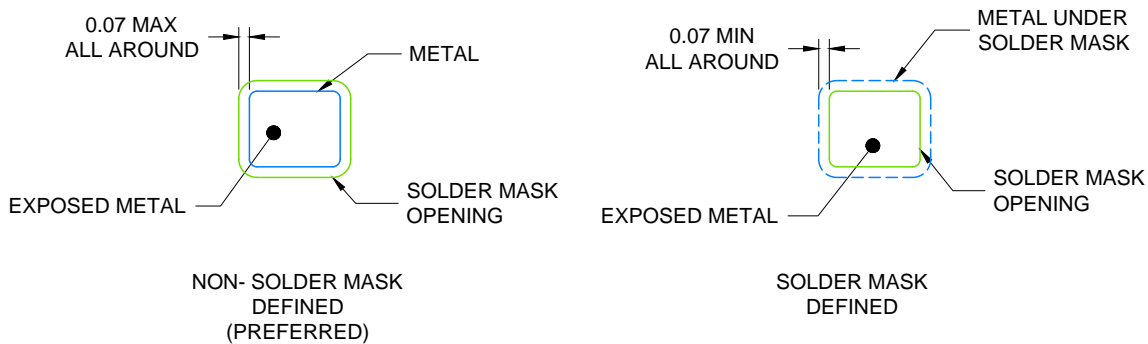

SOLDER MASK DETAILS

4225945/B 10/2020

NOTES: (continued)

3. For more information, see Texas Instruments literature number SLUA271 (www.ti.com/lit/sluea271) .

EXAMPLE STENCIL DESIGN

VSON - 1 mm max height

DLE0004A

PLASTIC QUAD FLAT PACK-NO LEAD

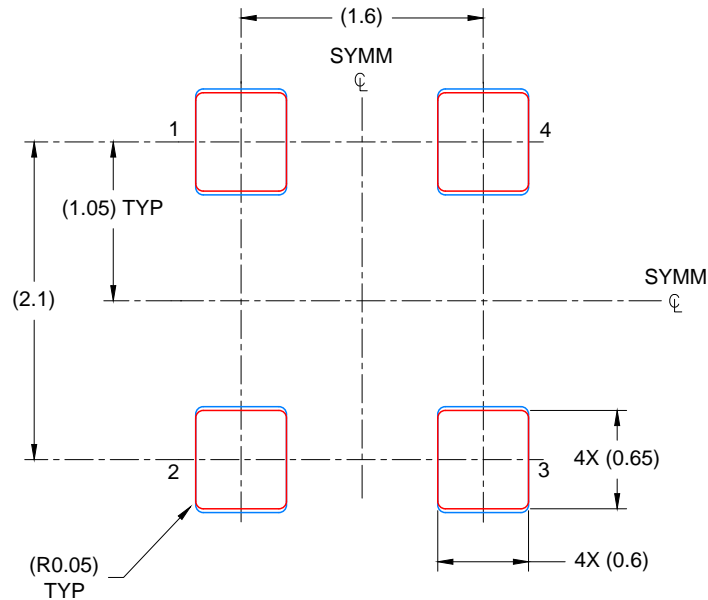

SOLDER PASTE EXAMPLE
BASED ON 0.125 mm THICK STENCIL

PRINTED SOLDER COVERAGE BY AREA UNDER PACKAGE
ALL PADS: 93%
SCALE: 20X

4225945/B 10/2020

NOTES: (continued)

4. Laser cutting apertures with trapezoidal walls and rounded corners may offer better paste release. IPC-7525 may have alternate design recommendations.

GENERIC PACKAGE VIEW

DLF 4

VSON - 1 mm max height

2 x 2.5, 1.65 mm pitch

PLASTIC QUAD FLAT PACK-NO LEAD

This image is a representation of the package family, actual package may vary.
Refer to the product data sheet for package details.

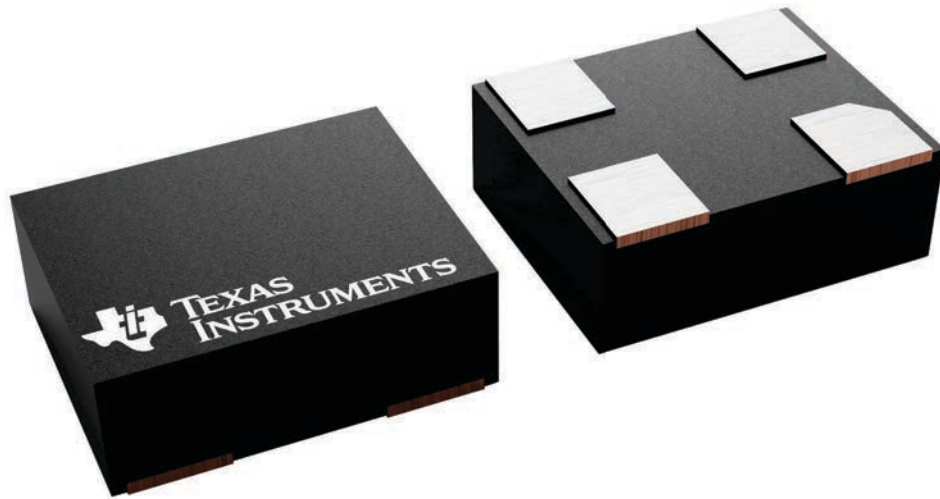

4231598/A

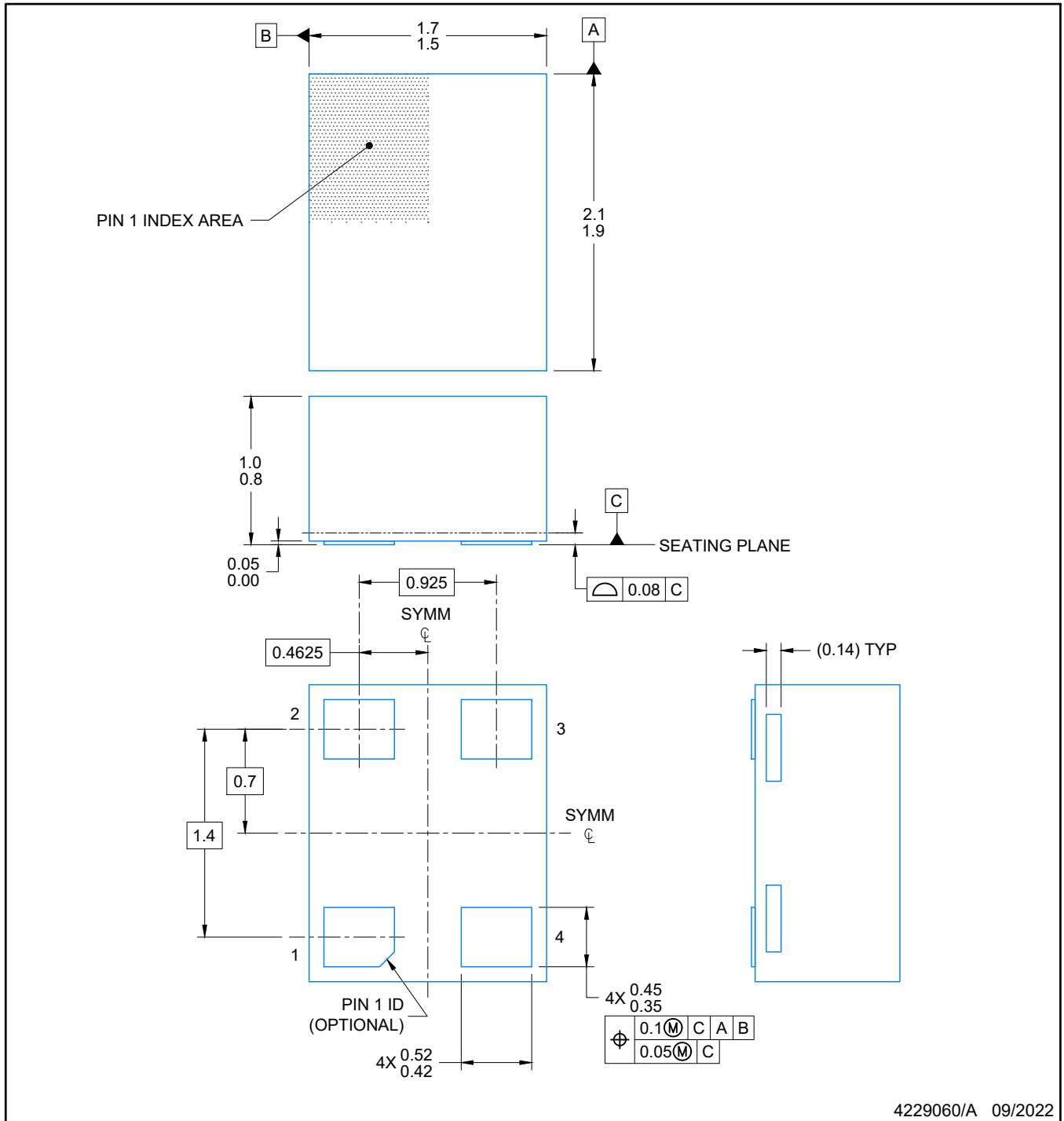

NOTES:

1. All linear dimensions are in millimeters. Any dimensions in parenthesis are for reference only. Dimensioning and tolerancing per ASME Y14.5M.
2. This drawing is subject to change without notice.

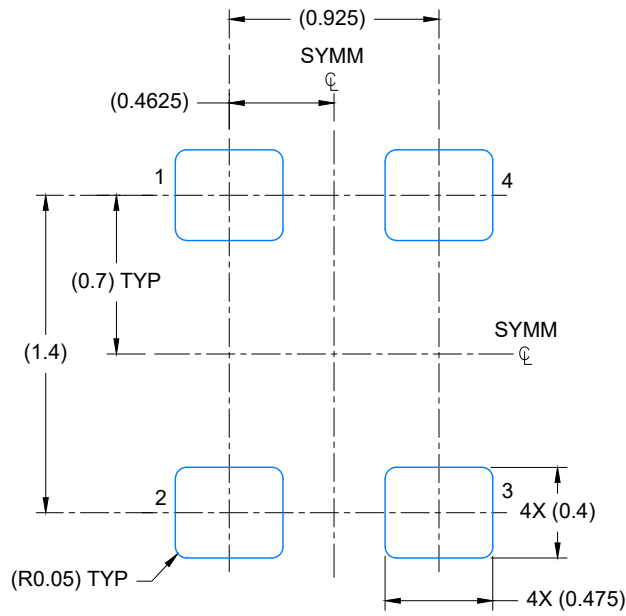

LAND PATTERN EXAMPLE
EXPOSED METAL SHOWN
SCALE: 30X

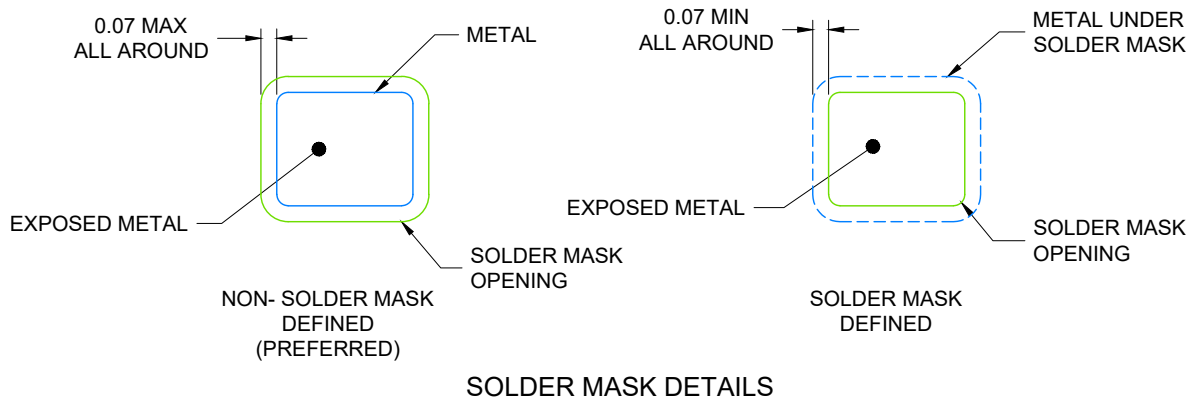

SOLDER MASK DETAILS

4229060/A 09/2022

NOTES: (continued)

- For more information, see Texas Instruments literature number SLUA271 (www.ti.com/lit/slua271).

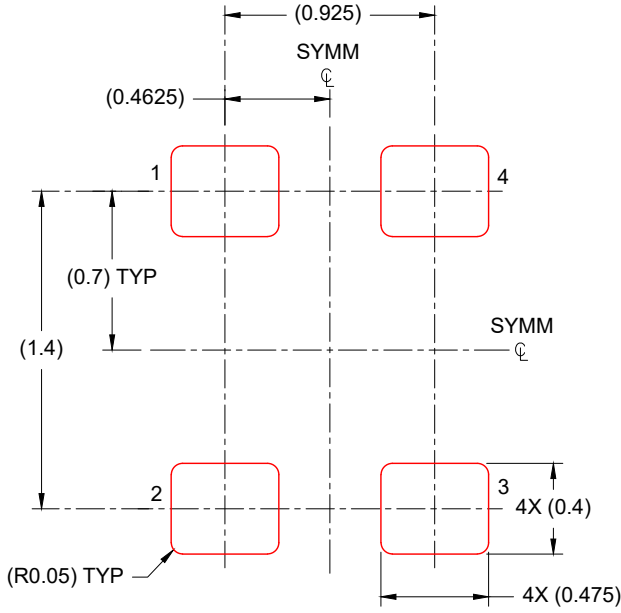

SOLDER PASTE EXAMPLE
BASED ON 0.125 mm THICK STENCIL
SCALE: 20X

4229060/A 09/2022

NOTES: (continued)

- 4. Laser cutting apertures with trapezoidal walls and rounded corners may offer better paste release. IPC-7525 may have alternate design recommendations.

GENERIC PACKAGE VIEW

DLY 4

VSON - 1 mm max height

1.6 x 1.2, 0.7 mm pitch

PLASTIC QUAD FLATPACK - NO LEAD

This image is a representation of the package family, actual package may vary.
Refer to the product data sheet for package details.

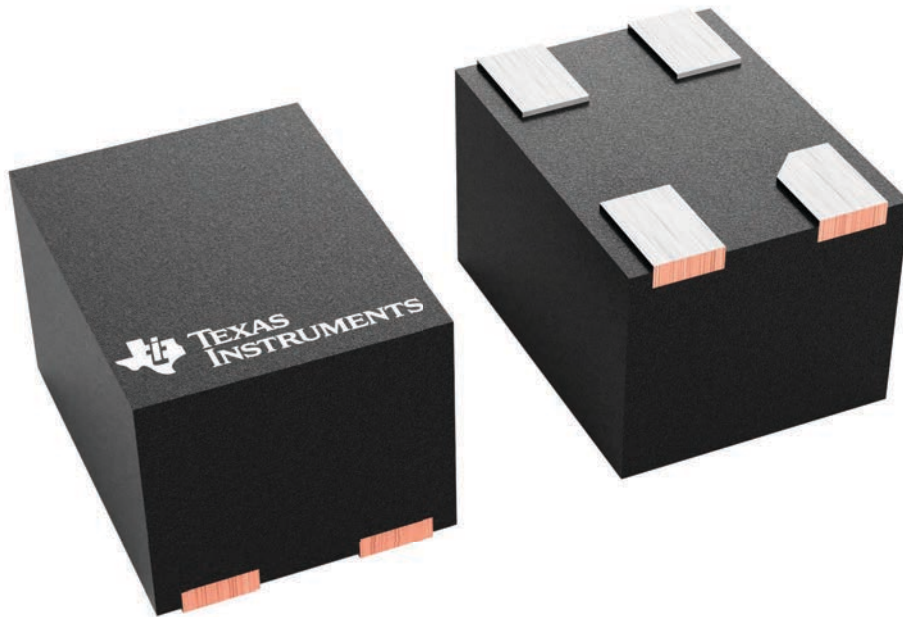

4229365/A

IMPORTANT NOTICE AND DISCLAIMER

TI PROVIDES TECHNICAL AND RELIABILITY DATA (INCLUDING DATA SHEETS), DESIGN RESOURCES (INCLUDING REFERENCE DESIGNS), APPLICATION OR OTHER DESIGN ADVICE, WEB TOOLS, SAFETY INFORMATION, AND OTHER RESOURCES "AS IS" AND WITH ALL FAULTS, AND DISCLAIMS ALL WARRANTIES, EXPRESS AND IMPLIED, INCLUDING WITHOUT LIMITATION ANY IMPLIED WARRANTIES OF MERCHANTABILITY, FITNESS FOR A PARTICULAR PURPOSE OR NON-INFRINGEMENT OF THIRD PARTY INTELLECTUAL PROPERTY RIGHTS.

These resources are intended for skilled developers designing with TI products. You are solely responsible for (1) selecting the appropriate TI products for your application, (2) designing, validating and testing your application, and (3) ensuring your application meets applicable standards, and any other safety, security, regulatory or other requirements.

These resources are subject to change without notice. TI grants you permission to use these resources only for development of an application that uses the TI products described in the resource. Other reproduction and display of these resources is prohibited. No license is granted to any other TI intellectual property right or to any third party intellectual property right. TI disclaims responsibility for, and you will fully indemnify TI and its representatives against, any claims, damages, costs, losses, and liabilities arising out of your use of these resources.

TI's products are provided subject to [TI's Terms of Sale](#) or other applicable terms available either on [ti.com](https://www.ti.com) or provided in conjunction with such TI products. TI's provision of these resources does not expand or otherwise alter TI's applicable warranties or warranty disclaimers for TI products.

TI objects to and rejects any additional or different terms you may have proposed.

Mailing Address: Texas Instruments, Post Office Box 655303, Dallas, Texas 75265
Copyright © 2025, Texas Instruments Incorporated