

TPSM843620 4V to 18V Input, 6A, Buck Power Module With Internally Compensated, Advanced Current Mode Control

1 Features

- Fixed-frequency, internally-compensated Advanced Current Mode (ACM) control
- Small form factor 3.5mm × 3.5mm × 1.6mm, 15-pin DFM package MicroSiP™ power module
- High-efficiency, integrated 25mΩ and 6.5mΩ MOSFETs, inductor and basic passives
- 4V to 18V input voltage range
- 0.5V to 5.5V output voltage range
- Three selectable PWM ramp options to optimize the control loop performance
- Five selectable switching frequencies: 500kHz, 750kHz, 1MHz, 1.5MHz, and 2.2MHz
- Synchronizable to an external clock
- 0.5V, ±0.5% voltage reference accuracy over full temperature range
- Selectable soft-start times: 0.5ms, 1ms, 2ms, and 4ms
- Monotonic start-up into prebiased outputs
- Selectable current limits to support lower current operation
- Enable with adjustable input undervoltage lockout
- Power-good output monitor
- Output overvoltage, output undervoltage, input undervoltage, overcurrent, and overtemperature protection
- Pin-to-pin compatible with 8A - [TPSM843820](#), 3A - [TPSM843320](#)
- – 40°C to 125°C operating junction temperature

2 Applications

- [Wireless infrastructure and wired communications equipment](#)
- [Optical module](#)
- [Test and measurement](#)
- [Medical and healthcare](#)
- [Aerospace and defense](#)

3 Description

TPSM843620 is a highly efficient, small, and flexible synchronous step-down DC-DC converter in a MicroSiP power module package that is easy to use. The module operates up to 18V input with fixed-frequencies that are resistor adjustable by system designer. The embedded IC is internally compensated which reduces external components and design size. The integrated high-frequency capacitor reduces the transient peak at switching node.

The TPSM843620 module employs an internally compensated, fixed-frequency advanced current mode control. The device is capable of providing high efficiency while running at a switching frequency up to 2.2MHz. The fixed frequency controller can operate from 500kHz to 2.2MHz and can be synchronized to an external clock using the SYNC pin. Additional features include a high accuracy voltage reference, selectable soft-start times, monotonic start-up into prebiased outputs, selectable current limits, adjustable UVLO through the EN pin, and a full suite of fault protections.

Package Information

PART NUMBER	PACKAGE ⁽¹⁾	PACKAGE SIZE ⁽²⁾
TPSM843620	SIT (uSiP, 15)	3.50mm × 3.50mm

(1) For more information, see [Section 10](#).

(2) The package size (length × width) is a nominal value and includes pins, where applicable.

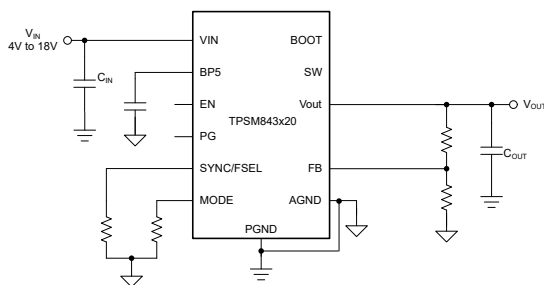

Simplified Schematic

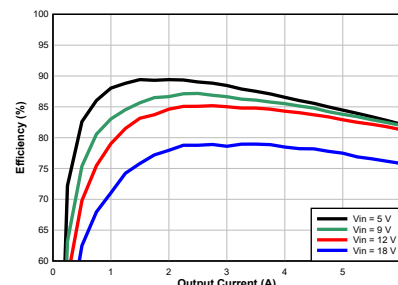

Efficiency



Table of Contents

1 Features	1	6.4 Device Functional Modes.....	17
2 Applications	1	7 Application and Implementation	19
3 Description	1	7.1 Application Information.....	19
4 Pin Configuration and Functions	3	7.2 Typical Applications.....	19
5 Specifications	4	7.3 Power Supply Recommendations.....	29
5.1 Absolute Maximum Ratings.....	4	7.4 Layout.....	29
5.2 ESD Ratings.....	4	8 Device and Documentation Support	32
5.3 Recommended Operating Conditions.....	4	8.1 Receiving Notification of Documentation Updates... 32	
5.4 Thermal Information.....	4	8.2 Support Resources.....	32
5.5 Electrical Characteristics (Module).....	4	8.3 Trademarks.....	32
5.6 Typical Characteristics.....	7	8.4 Electrostatic Discharge Caution.....	32
6 Detailed Description	10	8.5 Glossary.....	32
6.1 Overview.....	10	9 Revision History	32
6.2 Functional Block Diagram.....	10	10 Mechanical, Packaging, and Orderable Information	33
6.3 Feature Description.....	10		

4 Pin Configuration and Functions

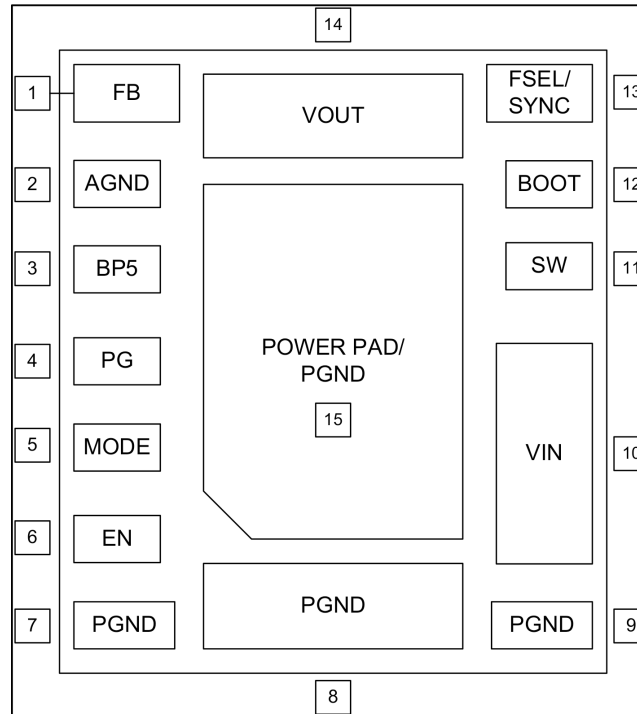

Figure 4-1. SIT Package 15-Pin uSiP (Top View)

Table 4-1. Pin Functions

PIN		TYPE ⁽¹⁾	DESCRIPTION
NAME	NO.		
FB	1	I	Feedback pin for output voltage regulation. Connect this pin to the midpoint of a resistor divider to set the output voltage.
AGND	2	—	Ground return for internal analog circuits
BP5	3	O	Internal 5V regulator output. Bypass this pin with a 2.2μF capacitor to AGND.
PG	4	O	Open-drain power-good indicator
MODE	5	I	A resistor to ground selects the current limit, soft-start rate, and PWM ramp amplitude.
EN	6	I	Enable pin. Float to enable, enable and disable with an external signal, or adjust the input undervoltage lockout with a resistor divider.
PGND	7, 8, 9	—	Ground return for the power stage. This pin is internally connected to the source of the low-side MOSFET.
VIN	10	I	Input power to the power stage. Low impedance bypassing of these pins to PGND is critical. A 47nF to 100nF capacitor from VIN to PGND close to IC is required.
SW	11	DNC	Switch node of the module, used for monitoring only
BOOT	12	DNC	Supply for the internal high-side MOSFET gate driver. This pin is monitoring only because the capacitor to SW pin is integrated
SYNC/ FSEL	13	I	Frequency select and external clock synchronization. A resistor to ground sets the switching frequency of the device. An external clock can also be applied to this pin to synchronize the switching frequency.
VOUT	14	O	Buck output voltage. Connect output capacitors to this node.
PAD/ PGND	15	—	Thermal pad connected to PGND

(1) I = input, O = output

5 Specifications

5.1 Absolute Maximum Ratings

over operating free-air temperature range (unless otherwise noted) ⁽¹⁾

		MIN	MAX	UNIT
Input voltage	V _{IN}	-0.3	20	V
Input voltage	V _{IN} to SW, DC	-0.3	20	V
Input voltage	V _{IN} to SW, transient 20ns	-6	25	V
Input voltage	BOOT	-0.3	25	V
Input voltage	BOOT to SW	-0.3	6	V
Input voltage	EN, PGOOD, MODE, SYNC/FSEL, FB	-0.3	6	V
Output voltage	SW, DC	-0.3	20	V
Output voltage	SW, transient 20ns	-5	22	V
Operating junction temperature, T _J	Operating junction temperature, T _J	-40	125	°C
Storage temperature, T _{stg}		-55	150	°C

- (1) Operation outside the Absolute Maximum Ratings may cause permanent device damage. Absolute Maximum Ratings do not imply functional operation of the device at these or any other conditions beyond those listed under Recommended Operating Conditions. If used outside the Recommended Operating Conditions but within the Absolute Maximum Ratings, the device may not be fully functional, and this may affect device reliability, functionality, performance, and shorten the device lifetime.

5.2 ESD Ratings

			VALUE	UNIT
V _(ESD)	Electrostatic discharge	Human-body model (HBM), per ANSI/ESDA/JEDEC JS-001 ⁽¹⁾	±2000	V
V _(ESD)	Electrostatic discharge	Charged-device model (CDM), per ANSI/ESDA/JEDEC JS-002 ⁽²⁾	±500	V

- (1) JEDEC document JEP155 states that 500-V HBM allows safe manufacturing with a standard ESD control process.
 (2) JEDEC document JEP157 states that 250-V CDM allows safe manufacturing with a standard ESD control process.

5.3 Recommended Operating Conditions

over operating free-air temperature range (unless otherwise noted)

		MIN	NOM	MAX	UNIT
Input voltage	V _{IN}	4		18	V
Input voltage	SYNC/FSEL, EN, PGOOD	-0.1		5.5	V
Output voltage	V _{OUT}	0.5		5.5	V
Output current	I _{OUT}			6	A
T _J	Operating junction temperature	-40		125	°C
f _{SYNC}	External clock frequency	400		2600	kHz

5.4 Thermal Information

THERMAL METRIC ⁽¹⁾		TPSM843x20	UNIT
		uSiP (TI EVM)	
		15 PINS	
R _{θJA}	Junction-to-ambient thermal resistance	31.2	°C/W
ψ _{JB}	Junction-to-board characterization parameter	8.99	°C/W

- (1) For more information about traditional and new thermal metrics, see the [Semiconductor and IC Package Thermal Metrics](#) application report.

5.5 Electrical Characteristics (Module)

T_J = -40°C to +125°C, V_{VIN} = 4V - 18V (unless otherwise noted)

PARAMETER	TEST CONDITIONS	MIN	TYP	MAX	UNIT
SUPPLY VOLTAGE					

5.5 Electrical Characteristics (Module) (continued)

$T_J = -40^{\circ}\text{C}$ to $+125^{\circ}\text{C}$, $V_{VIN} = 4\text{V} - 18\text{V}$ (unless otherwise noted)

PARAMETER		TEST CONDITIONS	MIN	TYP	MAX	UNIT
$I_{Q(VIN)}$	VIN operating non-switching supply current	$V_{EN} = 1.3\text{V}$, $V_{FB} = 550\text{mV}$, $V_{VIN} = 12\text{V}$, 1MHz		1200	1600	μA
$I_{SD(VIN)}$	VIN shutdown supply current	$V_{EN} = 0\text{V}$, $V_{VIN} = 12\text{V}$		15	25	μA
	VIN UVLO rising threshold	VIN rising	3.9	4	4.1	V
	VIN UVLO hysteresis			150		mV
ENABLE AND UVLO						
$V_{EN(\text{rise})}$	EN voltage rising threshold	EN rising, enable switching		1.2	1.25	V
$V_{EN(\text{fall})}$	EN voltage falling threshold	EN falling, disable switching	1.05	1.1		V
$V_{EN(\text{hyst})}$	EN voltage hysteresis			100		mV
	EN pin sourcing current	$V_{EN} = 1.1\text{V}$	0.4	1.5		μA
	EN pin sourcing current	$V_{EN} = 1.3\text{V}$		11.6		μA
INTERNAL LDO BP5						
V_{BP5}	Internal LDO BP5 output voltage	$V_{VIN} = 12\text{V}$		4.5		V
	BP5 dropout voltage	$V_{VIN} - V_{BP5}$, $V_{VIN} = 3.8\text{V}$			350	mV
	BP5 short-circuit current limit	$V_{VIN} = 12\text{V}$		75		mA
REFERENCE VOLTAGE						
V_{FB}	Feedback Voltage	$T_J = -40^{\circ}\text{C}$ to 125°C	495	500	505	mV
$I_{FB(LKG)}$	Input leakage current into FB pin	$V_{FB} = 500\text{mV}$, non-switching, $V_{VIN} = 12\text{V}$, $V_{EN} = 0\text{V}$		1		nA
SWITCHING FREQUENCY AND OSCILLATOR						
f_{SW}	Switching frequency	$R_{FSEL} = 24.3\text{k}\Omega$	450	500	550	kHz
f_{SW}	Switching frequency	$R_{FSEL} = 17.4\text{k}\Omega$	675	750	825	kHz
f_{SW}	Switching frequency	$R_{FSEL} = 11.8\text{k}\Omega$	900	1000	1100	kHz
f_{SW}	Switching frequency	$R_{FSEL} = 8.06\text{k}\Omega$	1350	1500	1650	kHz
f_{SW}	Switching frequency	$R_{FSEL} = 4.99\text{k}\Omega$	1980	2200	2420	kHz
SYNCHRONIZATION						
$V_{IH(\text{sync})}$	High-level input voltage		1.8			V
$V_{IL(\text{sync})}$	Low-level input voltage				0.8	V
SOFT-START						
t_{SS1}	Soft-start time	$R_{MODE} = 1.78\text{k}\Omega$		0.5		ms
t_{SS2}	Soft-start time	$R_{MODE} = 2.21\text{k}\Omega$		1		ms
t_{SS3}	Soft-start time	$R_{MODE} = 2.74\text{k}\Omega$		2		ms
t_{SS4}	Soft-start time	$R_{MODE} = 3.32\text{k}\Omega$		4		ms
POWER STAGE						
$R_{DS(\text{on})HS}$	High-side MOSFET on-resistance	$T_J = 25^{\circ}\text{C}$, $V_{VIN} = 12\text{V}$, $V_{BOOT-SW} = 4.5\text{V}$		25		m Ω
$R_{DS(\text{on})LS1}$	Low-side MOSFET on-resistance: high current limit selected	$T_J = 25^{\circ}\text{C}$, $V_{BP5} = 4.5\text{V}$, $R_{MODE} = 1.78\text{k}\Omega$		6.5		m Ω
$R_{DS(\text{on})LS2}$	Low-side MOSFET on-resistance: low current limit selected	$T_J = 25^{\circ}\text{C}$, $V_{BP5} = 4.5\text{V}$, $R_{MODE} = 22.1\text{k}\Omega$		13.9		m Ω
$V_{BOOT-SW(UV_r)}$	BOOT-SW UVLO rising threshold	$V_{BOOT-SW}$ rising		3.2		V
$V_{BOOT-SW(UV_f)}$	BOOT-SW UVLO falling threshold	$V_{BOOT-SW}$ falling		2.8		V
$T_{ON(\text{min})}$	Minimum ON pulse width	$I_{OUT} > \frac{1}{2} I_{L_PK-PK}$		30	37	ns
$T_{OFF(\text{min})}$	Minimum OFF pulse width ⁽¹⁾			115	140	ns
CURRENT SENSE AND OVERCURRENT PROTECTION						
$I_{OC_HS_pk1}$	High-side peak current limit(6A)	$R_{MODE} = 1.78\text{k}\Omega$	8.6	9	9.6	A
$I_{OC_HS_pk2}$	High-side peak current limit(6A)	$R_{MODE} = 22.1\text{k}\Omega$	4.2	4.5	4.8	A
$I_{OC_LS_src1}$	Low-side sourcing current limit(6A)	$R_{MODE} = 1.78\text{k}\Omega$	6.4	7.3	8.1	A
$I_{OC_LS_src2}$	Low-side sourcing current limit(6A)	$R_{MODE} = 22.1\text{k}\Omega$	3.65	4.2	4.65	A
$I_{OC_LS_snk}$	Low-side sinking current limit	Current into SW pin	2.95			A
OUTPUT OVERVOLTAGE AND UNDERVOLTAGE PROTECTIONS						

5.5 Electrical Characteristics (Module) (continued)

$T_J = -40^{\circ}\text{C}$ to $+125^{\circ}\text{C}$, $V_{VIN} = 4\text{V} - 18\text{V}$ (unless otherwise noted)

PARAMETER		TEST CONDITIONS	MIN	TYP	MAX	UNIT
V_{OVP}	Overvoltage-protection (OVP) threshold voltage	V_{FB} rising		120		% V_{REF}
V_{UVP}	Undervoltage-protection (UVP) threshold voltage	V_{FB} falling		80		% V_{REF}
POWER GOOD						
	PGOOD threshold	V_{FB} rising (Fault)	113	116	119	% V_{REF}
	PGOOD threshold	V_{FB} falling (Good)	105	108	111	% V_{REF}
	PGOOD threshold	V_{FB} rising (Good)	89	92	95	% V_{REF}
	PGOOD threshold	V_{FB} falling (Fault)	81	84	87	% V_{REF}
$I_{PGOOD(LKG)}$	Leakage current into PGOOD pin when open drain output is high	$V_{PGOOD} = 4.7\text{V}$			5	μA
$V_{PG(low)}$	PGOOD low-level output voltage	$I_{PGOOD} = 2\text{mA}$, $V_{IN} = 12\text{V}$			0.5	V
	Min V_{IN} for valid PGOOD output			0.9	1	V
HICCUP						
	Hiccup time before re-start			$7 \cdot t_{SS}$		ms
OUTPUT DISCHARGE						
R_{Dischg}	Output discharge resistance	$V_{VIN} = 12\text{V}$, $V_{SW} = 0.5\text{V}$, power conversion disabled.		100		Ω
THERMAL SHUTDOWN						
T_{SDN}	Thermal shutdown threshold ⁽¹⁾	Temperature rising		165	175	$^{\circ}\text{C}$
T_{HYST}	Thermal shutdown hysteresis ⁽¹⁾			12		$^{\circ}\text{C}$

(1) Specified by design. Not production tested.

5.6 Typical Characteristics

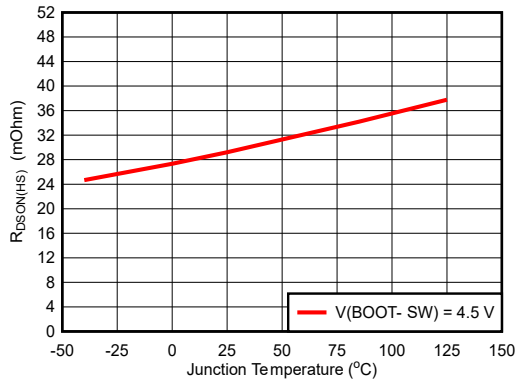

Figure 5-1. High-Side FET RdON

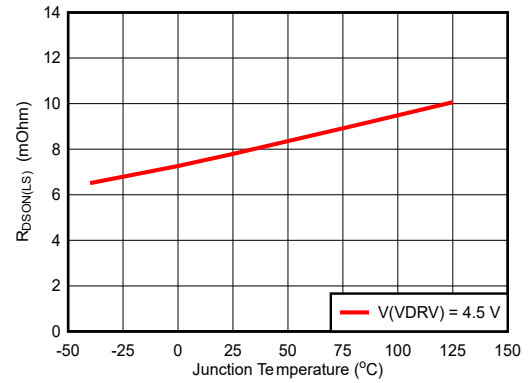

Figure 5-2. Low-Side FET RdON

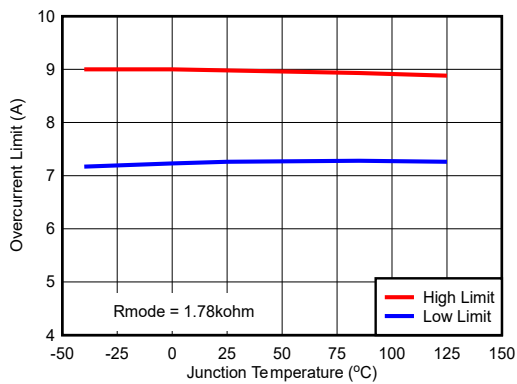

Figure 5-3. Overcurrent Limit : R = 1.78kOhm

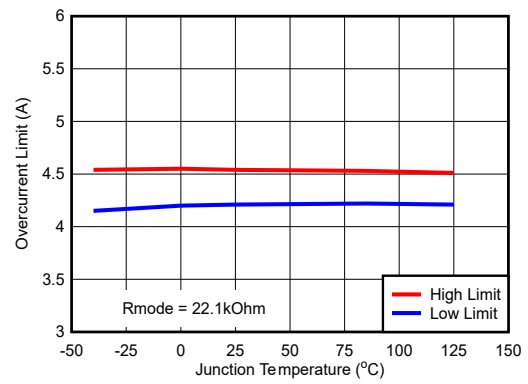

Figure 5-4. Overcurrent Limit : R = 22.1kOhm

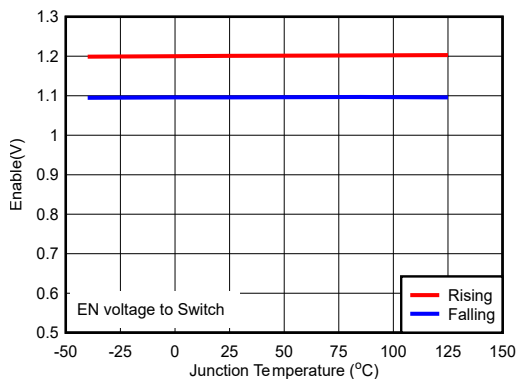

Figure 5-5. Enable Voltage

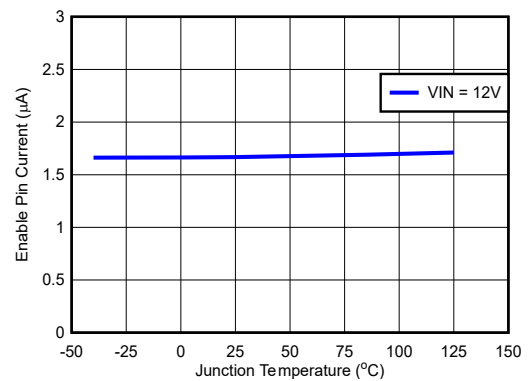

Figure 5-6. Enable Pin Current

5.6 Typical Characteristics (continued)

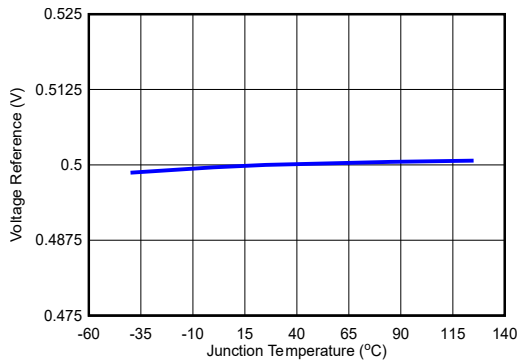

Figure 5-7. Voltage Reference

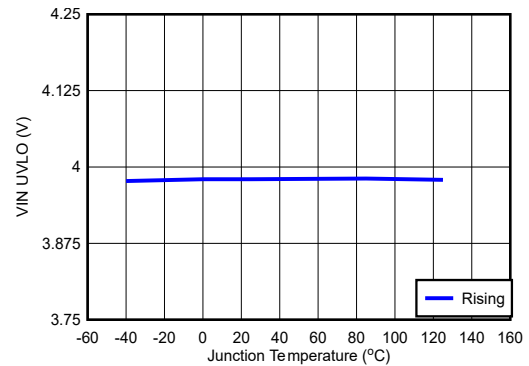

Figure 5-8. Vin UVLO

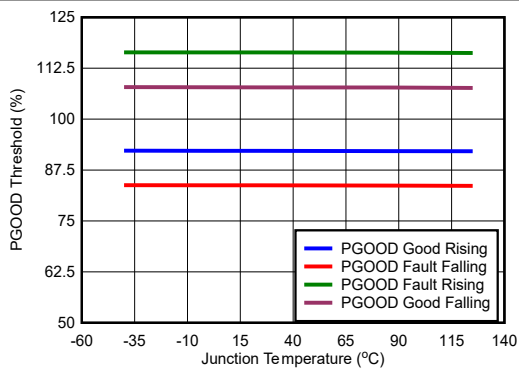

Figure 5-9. PG Threshold

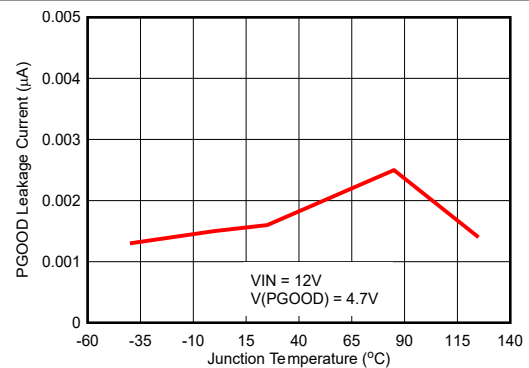

Figure 5-10. PG Leakage

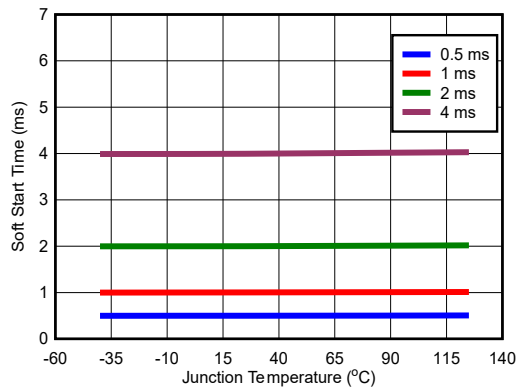

Figure 5-11. Soft Start

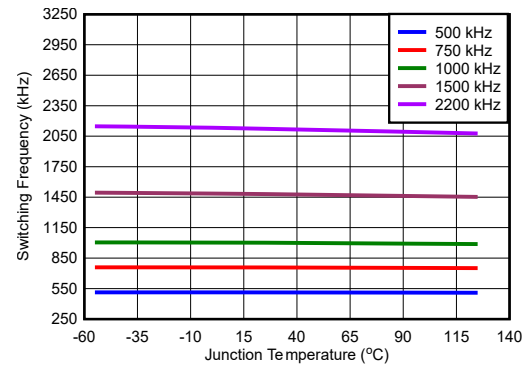

Figure 5-12. Switching Frequency

5.6 Typical Characteristics (continued)

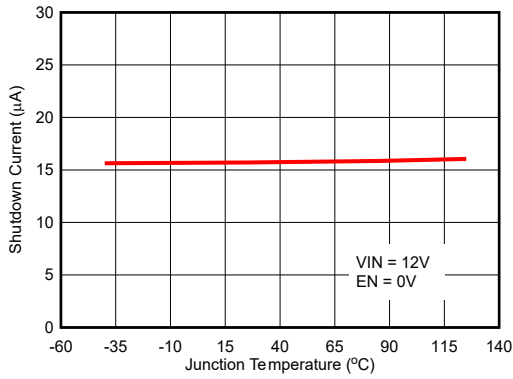

Figure 5-13. Shutdown Current

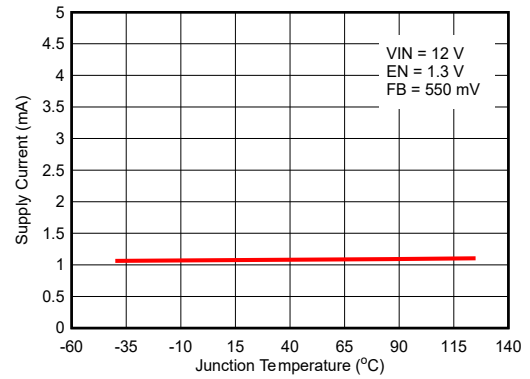

Figure 5-14. Non-Switching Supply Current

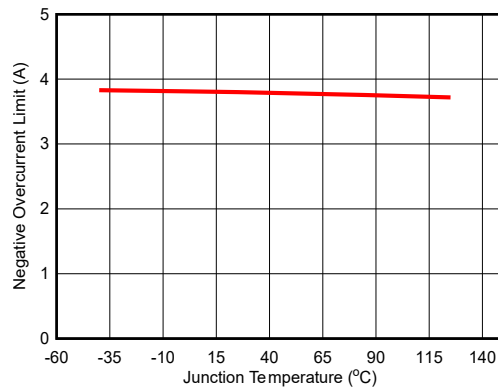

Figure 5-15. Negative Overcurrent

6 Detailed Description

6.1 Overview

The TPSM843620 device is a 6A, high-performance, synchronous buck converter module with integrated inductor and discretes. The TPSM843620 has a maximum operating junction temperature of 125°C, making the device an excellent choice for high-ambient temperature applications such as wireless infrastructure. The input voltage range is 4V to 18V and the output voltage range is 0.5V to 5.5V. The device features a fixed-frequency Advanced Current Mode control with a switching frequency of 500kHz to 2.2MHz, allowing for efficiency and size optimization when selecting output filter components. The switching frequency of the device can be synchronized to an external clock applied to the SYNC pin.

Advanced Current Mode (ACM) is an emulated peak current control topology. Advanced Current Mode supports stable static and transient operation without complex external compensation design. This control architecture includes an internal ramp generation network that emulates inductor current information, enabling the use of low-ESR output capacitors such as multi-layered ceramic capacitors (MLCC). The internal ramp also creates a high signal-to-noise ratio for good noise immunity. The TPSM843620 has three ramp options (see [Section 6.3.6](#) for details) to optimize the internal loop for various inductor and output capacitor combinations with only a single resistor to AGND. The TPSM843620 is easy-to-use and allows low external component count with fast load transient response. Fixed-frequency operation also provides ease-of-filter design to overcome EMI noise.

6.2 Functional Block Diagram

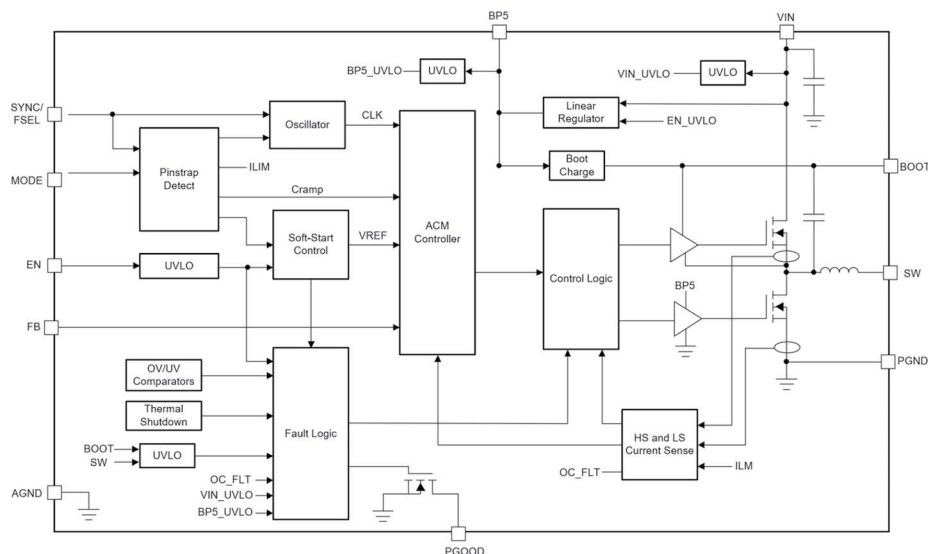

6.3 Feature Description

6.3.1 VIN Pins and VIN UVLO

The VIN pin voltage supplies the internal control circuits of the device and provides the input voltage to the power stage. The input voltage for VIN can range from 4V to 18V. The device implements internal UVLO circuitry on the VIN pin. The device is disabled when the VIN pin voltage falls below the internal VIN UVLO threshold. The internal VIN UVLO threshold has a hysteresis of 150mV. A voltage divider connected to the EN pin can adjust the input voltage UVLO as appropriate. See [Section 6.3.2](#) for more details.

6.3.2 Enable and Adjustable UVLO

The EN pin provides on and off control of the device. After the EN pin voltage exceeds the threshold voltage, the device begins the start-up sequence. If the EN pin voltage is pulled below the threshold voltage, the regulator stops switching and enters a low operating current state. The EN pin has an internal pullup current source, I_p , allowing the pin to be floated to enable the device by default. Make that leakage currents of anything connected

to the EN pin do not exceed the minimum EN pullup current or the device can not be able to start. If an application requires controlling the EN pin, an open drain or open collector output logic can be interfaced with the pin.

When the EN pin voltage exceeds the threshold voltage and the VIN pin voltage exceeds the VIN UVLO threshold, the device begins the start-up sequence. First, the BP5 LDO is enabled and charges the external BP5 capacitor. After the voltage on the BP5 pin exceeds the UVLO threshold, the device enters a power-on delay. During the power-on delay, the values of the pinstrap resistors on the MODE pin (see [Section 6.3.8](#)) and SYNC/FSEL pin (see [Section 6.3.4](#)) are determined and the control loop is initialized. The power-on delay is typically 600µs. After the power-on delay, soft start begins.

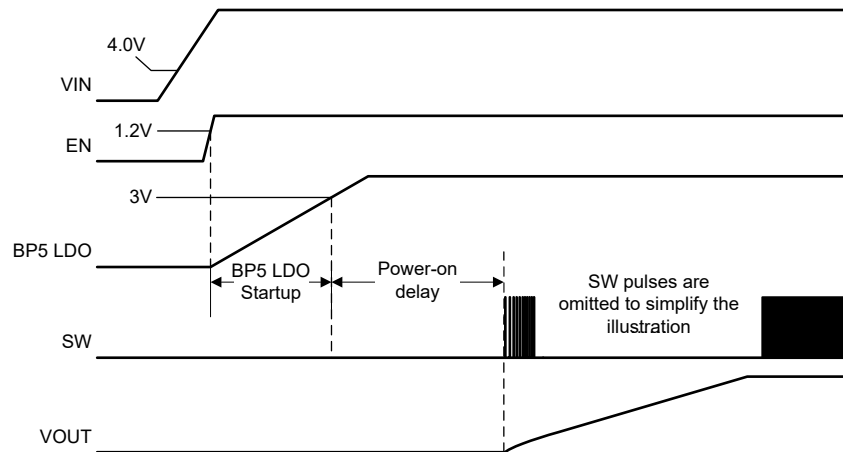

Figure 6-1. Start-Up Sequence

An external resistor divider can be added from VIN to the EN pin for adjustable UVLO and hysteresis as shown in [Figure 6-2](#). The EN pin has a small pullup current, I_p , which sets the default state of the pin to enable when no external components are connected. The pullup current is also used to control the voltage hysteresis for the UVLO function because it increases by I_h after the EN pin crosses the enable threshold. The UVLO thresholds can be calculated using [Equation 1](#) and [Equation 2](#). When using the adjustable UVLO function, TI recommends 500mV or greater hysteresis. For applications with very slow input voltage slew rate, a capacitor can be placed from the EN pin to ground to filter any glitches on the input voltage.

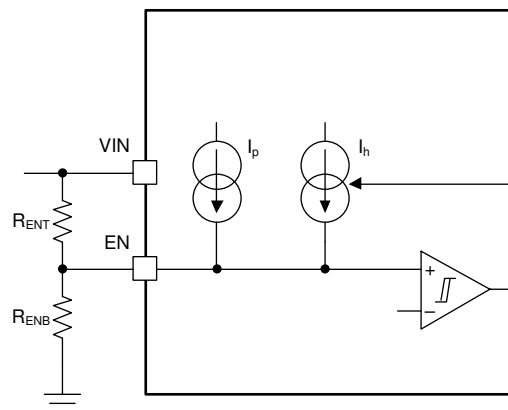

Figure 6-2. Adjustable UVLO Using EN

$$R_{ENT} = \frac{V_{START} \times \left(\frac{V_{ENFALLING}}{V_{ENRISING}} \right) - V_{STOP}}{I_p \times \left(1 - \frac{V_{ENFALLING}}{V_{ENRISING}} \right) + I_h} \quad (1)$$

$$R_{ENB} = \frac{R_{ENT} \times V_{ENFALLING}}{V_{STOP} - V_{ENFALLING} + R_{ENT} \times (I_p + I_h)} \quad (2)$$

6.3.3 Adjusting the Output Voltage

The output voltage is programmed with a resistor divider from the output (V_{OUT}) to the FB pin shown in [Figure 6-3](#). TI recommends to use 1% tolerance or better divider resistors. Starting with a fixed value for the bottom resistor, typically 10kΩ, use [Equation 3](#) to calculate the top resistor in the divider.

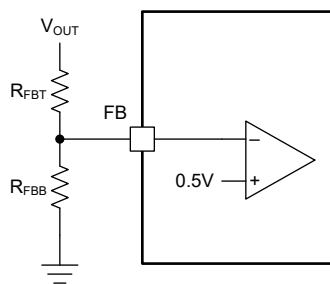

Figure 6-3. FB Resistor Divider

$$R_{FBT} = R_{FBB} \times \left(\frac{V_{OUT}}{V_{REF}} - 1 \right) \quad (3)$$

6.3.4 Switching Frequency Selection

The switching frequency of the device can be selected by connecting a resistor (R_{FSEL}) between the SYNC/FSEL pin and AGND. The frequency options and the corresponding programming resistors are listed in [Table 6-1](#). Use a 1% tolerance resistor or better.

Table 6-1. Switching Frequency Selection

R_{FSEL} ALLOWED NOMINAL RANGE (1%) (kΩ)	RECOMMENDED E96 STANDARD VALUE (1%) (kΩ)	RECOMMENDED E12 STANDARD VALUE (1%) (kΩ)	F_{sw} (kHz)
≥ 24.0	24.3	27	500
17.4-18.0	17.4	18	750
11.8-12.1	11.8	12	1000
8.06-8.25	8.06	8.2	1500
≤ 5.11	4.99	4.7	2200

6.3.5 Switching Frequency Synchronization to an External Clock

The device can be synchronized to an external clock by applying a square wave clock signal to the SYNC/FSEL pin with a duty cycle from 20% to 80%. The clock can either be applied before the device starts up or during operation. If the clock is to be applied before the device starts, a resistor between SYNC/FSEL and AGND is not needed. If the clock is to be applied after the device starts, then the clock frequency must be within ±20% of the frequency set by the SYNC/FSEL resistor. When the clock is applied after the device starts, the device begins synchronizing to this clock after counting four consecutive switching cycles with a clock pulse present. This is shown in [Figure 6-4](#).

6.3.5.1 Internal PWM Oscillator Frequency

When the external clock is present, the device synchronizes the switching frequency to the clock. Any time the external clock is not present, the device defaults to the internal PWM oscillator frequency.

If the device starts up before an external clock signal is applied, then the internal PWM oscillator frequency is set by the R_{FSEL} resistor according to [Table 6-1](#). The device switches at this frequency until the external clock is applied or anytime the external clock is not present.

If the external clock is applied before the device starts up, then the R_{FSEL} resistor is not needed. The device determines the internal clock frequency by decoding the external clock frequency. [Table 6-2](#) shows the decoding of the internal PWM oscillator frequency based on the external clock frequency.

Table 6-2. Internal Oscillator Frequency Decode

EXTERNAL SYNC CLOCK FREQUENCY (kHz)	DECODED INTERNAL PWM OSCILLATOR FREQUENCY (kHz)
400 - 600	500
600 - 857	750
857 - 1200	1000
1200 - 1810	1500
1810 - 2640	2200

The thresholds for the external SYNC clock frequency ranges have approximately a ±5% tolerance. If the external clock frequency must be within that tolerance range, decoding the internal PWM oscillator frequency as either the frequency above or below that threshold is possible. Because the internal frequency is what is used in case of the loss of the synchronization clock, TI recommends that the output LC filter and ramp selection are chosen to be stable for either frequency. [Table 6-3](#) shows the tolerance range of the decode thresholds. If the external clock is to be within any of these ranges, TI recommends to make sure converter stability for both possible internal PWM oscillator frequencies.

Table 6-3. Frequency Decode Thresholds

MINIMUM (kHz)	TYPICAL (kHz)	MAXIMUM (kHz)
570	600	630
814	857	900
1140	1200	1260
1736	1810	1884

6.3.5.2 Loss of Synchronization

If at any time during operation, there is a loss of synchronization, the device defaults to the internal PWM oscillator frequency until the synchronization clock returns. After the clock is no longer present, the device switches at 70% of the internal clock frequency for four consecutive cycles. After four consecutive cycles without clock pulses, the device operates at the normal internal PWM oscillator frequency. This action is demonstrated in Figure 6-4.

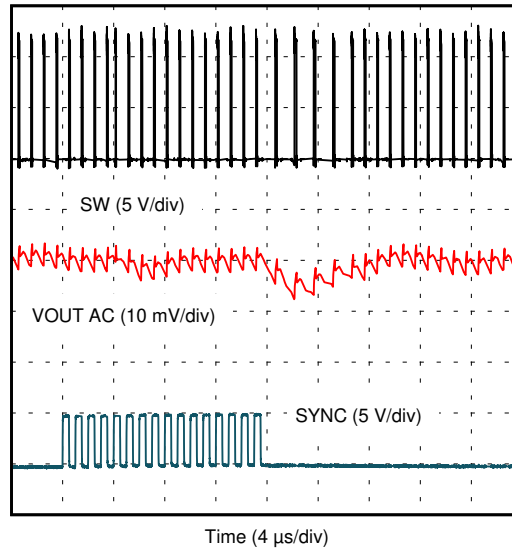

Figure 6-4. Clock Synchronization Transitions

6.3.5.3 Interfacing the SYNC/FSEL Pin

If an application requires synchronizing to a SYNC clock but the clock is unavailable before the device is enabled, TI recommends a high impedance buffer to make sure of proper detection of the R_{FSEL} value. Figure 6-5 shows the recommended implementation. The leakage current into the buffer output must be less than $5\mu\text{A}$ to make sure of proper detection of the R_{FSEL} value. Power the buffer from the BP5 output of the device to make sure the VCC voltage is available and the buffers output is high impedance before the device tries to detect the R_{FSEL} value. When powering the buffer from the BP5 pin, the external load on the BP5 pin must be less than 2 mA.

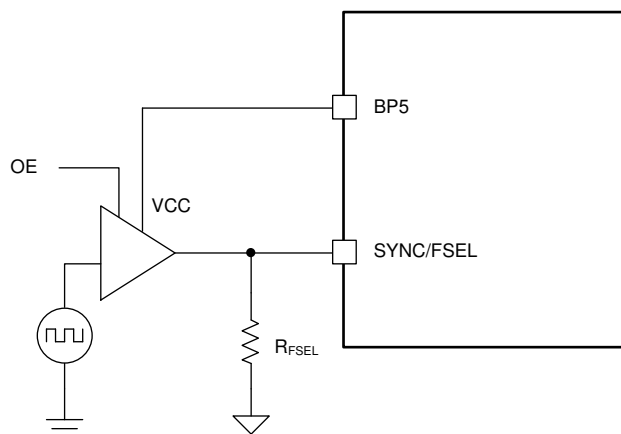

Figure 6-5. Interfacing the SYNC/FSEL Pin With a Buffer

6.3.6 Ramp Amplitude Selection

The TPSM843620 uses V_{IN} , duty cycle, and low-side FET current information to generate an internal ramp. The ramp amplitude is determined by an internal ramp generation capacitor, C_{RAMP} . Three different values for C_{RAMP} can be selected with a resistor to AGND on the MODE pin (see [Section 6.3.8](#)). The capacitor options are 1pF, 2pF, and 4pF. A larger ramp capacitor results in a smaller ramp amplitude, which results in a higher control loop bandwidth. [Figure 6-6](#) and [Figure 6-7](#) show how the loop changes with each ramp setting for the schematic in [Typical Applications](#).

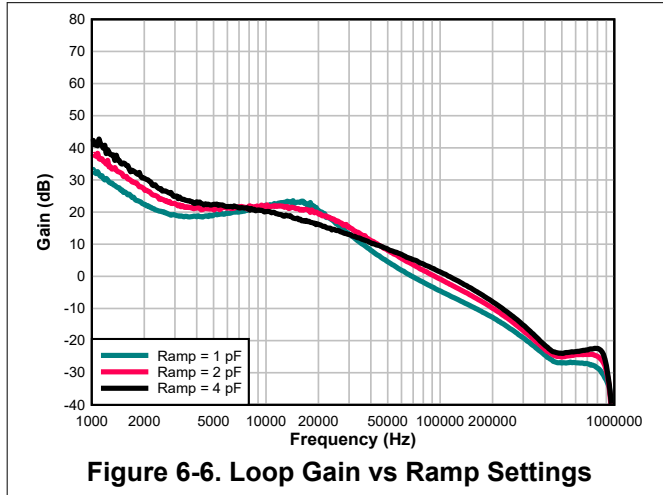

Figure 6-6. Loop Gain vs Ramp Settings

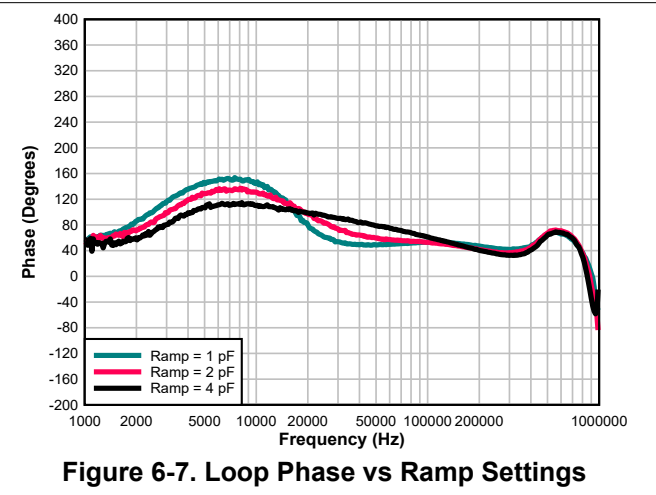

Figure 6-7. Loop Phase vs Ramp Settings

6.3.7 Soft Start and Prebiased Output Start-Up

During start-up, the device softly ramps the reference voltage to reduce inrush currents. There are four options for the soft-start time, which is the time the reference takes to ramp to 0.5V: 0.5ms, 1ms, 2ms, and 4 ms. The soft-start time is selected with a resistor to AGND on the MODE pin (see [Section 6.3.8](#)).

The device prevents current from being discharged from the output during start-up when a prebiased output condition exists. The device does this by operating in discontinuous conduction mode (DCM) during the first 16 cycles to prevent the device from sinking current. This action makes sure the output voltage is smooth and monotonic during soft start.

6.3.8 Mode Pin

The ramp amplitude, soft-start time, and current limit settings are programmed with a single resistor, R_{MODE} , between MODE and AGND. [Table 6-4](#) lists the resistor values for the available options. Use a 1% tolerance resistor or better. See [Section 6.3.10](#) for the corresponding current limit thresholds for the "High" and "Low" settings.

Table 6-4. MODE Pin Selection

R_{MODE} (k Ω)	CURRENT LIMITS	C_{RAMP} (pF)	SOFT-START TIME (ms)
1.78	High	1	0.5
2.21	High	1	1
2.74	High	1	2
3.32	High	1	4
4.02	High	2	0.5
4.87	High	2	1
5.9	High	2	2
7.32	High	2	4
9.09	High	4	0.5
11.3	High	4	1

Table 6-4. MODE Pin Selection (continued)

R _{MODE} (kΩ)	CURRENT LIMITS	C _{RAMP} (pF)	SOFT-START TIME (ms)
14.3	High	4	2
18.2	High	4	4
22.1	Low	1	0.5
26.7	Low	1	1
33.2	Low	1	2
40.2	Low	1	4
49.9	Low	2	0.5
60.4	Low	2	1
76.8	Low	2	2
102	Low	2	4
137	Low	4	0.5
174	Low	4	1
243	Low	4	2
412	Low	4	4

6.3.9 Power Good (PGOOD)

The PGOOD pin is an open-drain output requiring an external pullup resistor to output a high signal. After the FB pin is between 92% and 108% of the internal voltage reference, soft start is complete, and after a 256μs deglitch time, the PGOOD pin is de-asserted and the pin floats. TI recommends a pullup resistor between the values of 10kΩ and 100kΩ to a voltage source that is 5.5V or less. PGOOD is in a defined state after the VIN input voltage is greater than 1V but with reduced current sinking capability. When the FB is lower than 84% or greater than 116% of the nominal internal reference voltage, after a 8μs deglitch time, the PGOOD pin is pulled low. PGOOD is immediately pulled low if VIN falls below the UVLO, the EN pin is pulled low or the device enters thermal shutdown.

6.3.10 Current Protection

The protects against overcurrent events by cycle-by-cycle current limiting both the high-side MOSFET and low-side MOSFET. In an extended overcurrent condition, the device enters hiccup. Different protections are active during positive inductor current and negative inductor current conditions.

6.3.10.1 Positive Inductor Current Protection

The current is sensed in the high-side MOSFET while conducting after a short blanking time to allow noise to settle. Whenever the high-side overcurrent threshold is exceeded, the high-side MOSFET is immediately turned off and the low-side MOSFET is turned on. The high-side MOSFET does not turn back on until the current falls below the low-side MOSFET overcurrent threshold. This action effectively limits the peak current in the case of a short circuit condition. If a high-side overcurrent is detected for 15 consecutive cycles, the device enters hiccup.

The current is also sensed in the low-side MOSFET while it is conducting after a short blanking time to allow noise to settle. If the low-side overcurrent threshold is exceeded when the next incoming PWM signal is received from the controller, the device skips processing that PWM pulse. The device does not turn the high-side MOSFET on again until the low-side overcurrent threshold is no longer exceeded. If the low-side overcurrent threshold remains exceeded for 15 consecutive cycles, the device enters hiccup. There are two separate counters for the high-side and low-side overcurrent events. If the off-time is too short, the low-side overcurrent can not trip. The low-side overcurrent, however, begins tripping after the high-side peak overcurrent limit is hit as hitting the peak current limit shortens the on-time and lengthens the off-time.

Both the high-side and low-side positive overcurrent thresholds are programmable using the MODE pin. Two sets of thresholds are available ("High" and "Low"), which are summarized in [Table 6-5](#). The values for these thresholds are obtained using open-loop measurements with a DC current to accurately specify the values. In real applications, the inductor current ramps and the ramp rate is a function of the voltage across the inductor

($V_{IN} - V_{OUT}$) as well as the inductance value. This ramp rate combined with delays in the current sense circuitry can result in slightly different values than specified. The current at which the high-side overcurrent limit takes effect can be slightly higher than specified, and the current at which the low-side overcurrent limit takes effect can be slightly lower than specified.

Table 6-5. Overcurrent Thresholds

MODE PIN CURRENT LIMIT SETTING	HIGH-SIDE OVERCURRENT TYPICAL VALUE (A)	LOW-SIDE OVERCURRENT TYPICAL VALUE (A)
High	9.0	7.3
Low	4.5	4.2

6.3.10.2 Negative Inductor Current Protection

Negative current is sensed in the low-side MOSFET while it is conducting after a short blanking time to allow noise to settle. Whenever the low-side negative overcurrent threshold is exceeded, the low-side MOSFET is immediately turned off. The next high-side MOSFET turn-on is determined by the clock and PWM comparator. The negative overcurrent threshold minimum value is 2.95 A. Similar to the positive inductor current protections, the actual value of the inductor current when the current sense comparators trip is a function of the current ramp rate. As a result the current at which the negative inductor current limit takes effect can be slightly more negative than specified.

6.3.11 Output Overvoltage and Undervoltage Protection

The device incorporates both output overvoltage and undervoltage protection. If an overvoltage is detected, the device tries to discharge the output voltage to a safe level before attempting to restart. When the overvoltage threshold is exceeded, the low-side MOSFET is turned on until the low-side negative overcurrent threshold is reached. At this point, the high-side MOSFET is turned on until the inductor current reaches zero. Then, the low-side MOSFET is turned back on until the low-side negative overcurrent threshold is reached. This process repeats until the output voltage falls back into the PGOOD window. After this happens, the device restarts and goes through a soft start cycle. The device does not wait the hiccup time before restarting.

When an undervoltage condition is detected, the device enters hiccup where the device waits seven soft-start cycles before restarting. Undervoltage protection is enabled after soft start is complete.

6.3.12 Overtemperature Protection

When the die temperature exceeds 165°C, the device turns off. After the die temperature falls below the hysteresis level, typically 12°C, the device restarts. While waiting for the temperature to fall below the hysteresis level, the device does not switch or attempt to hiccup to restart. After the temperature falls below this level, the device restarts without going through hiccup.

6.3.13 Output Voltage Discharge

When the device is enabled, but the high-side FET and low-side FET are disabled due to a fault condition, the output voltage discharge mode is enabled. This mode turns on the discharge FET from SW to PGND to discharge the output voltage. The discharge FET is turned off when the converter is ready to resume switching, either after the fault clears or after the wait time before hiccup is over.

The output voltage discharge mode is activated by any of below fault events:

1. High-side or low-side positive overcurrent
2. Thermal shutdown
3. Output voltage undervoltage
4. VIN UVLO

6.4 Device Functional Modes

6.4.1 Forced Continuous-Conduction Mode

The TPSM843620 operates in forced continuous-conduction mode (FCCM) throughout normal operation.

6.4.2 Discontinuous Conduction Mode During Soft Start

During soft start, the converter operates in discontinuous conduction mode (DCM) during the first 16 PWM cycles. During this time, a zero-cross detect comparator is used to turn off the low-side MOSFET when the current reaches zero amps. This prevents the discharge of any prebiased conditions on the output. After 16 cycles of DCM, the converter enters FCCM mode.

7 Application and Implementation

Note

Information in the following applications sections is not part of the TI component specification, and TI does not warrant its accuracy or completeness. TI's customers are responsible for determining suitability of components for their purposes, as well as validating and testing their design implementation to confirm system functionality.

7.1 Application Information

The TPSM843620 is a synchronous buck regulator designed for 4V to 18V input and 6A load. This procedure illustrates the design of a high-frequency switching regulator using ceramic output capacitors.

7.2 Typical Applications

7.2.1 1.0V Output, 1MHz Application

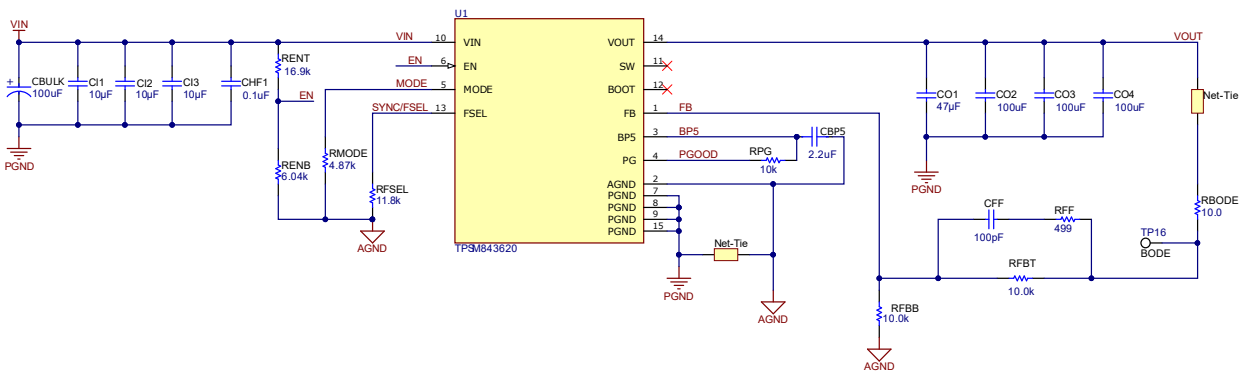

Figure 7-1. 12V Input, 1.0V Output, 1MHz Schematic

7.2.1.1 Design Requirements

For this design example, use the parameters shown in [Table 7-1](#).

Table 7-1. Design Parameters

PARAMETER	EXAMPLE VALUE
Input voltage range (V_{IN})	4V to 18V, 12V nominal
Output voltage (V_{OUT})	1.0V
Output current rating (I_{OUT})	6A
Switching frequency (f_{SW})	1000kHz
Steady state output ripple voltage	10mV
Output current load step	3A
Transient response	$\pm 30\text{mV}$ ($\pm 3\%$)

7.2.1.2 Detailed Design Procedure

7.2.1.2.1 Switching Frequency

The first step is to decide on a switching frequency. The TPSM843620 can operate at five different frequencies from 500kHz to 2.2MHz. The f_{SW} is set by the resistor value from the FSEL pin to ground. Typically, the highest switching frequency possible is desired because this switching frequency produces the smallest design size. A high switching frequency allows for smaller inductors and output capacitors compared to a power supply that switches at a lower frequency. The main tradeoff made with selecting a higher switching frequency is extra switching power loss, which hurts the efficiency of the regulator.

The maximum switching frequency for a given application can be limited by the minimum on-time of the regulator. The maximum f_{SW} can be estimated with Equation 4. Using the minimum on-time of 40 ns and 18V maximum input voltage for this application, the maximum switching frequency is 1390kHz. The selected switching frequency must also consider the tolerance of the switching frequency. A switching frequency of 1000kHz was selected for a good balance of design size and efficiency. To set the frequency to 1000kHz, the selected FSEL resistor is 11.8k Ω per Table 6-1.

$$f_{SW}(\max) = \frac{1}{t_{onmin}} \times \frac{V_{OUT}}{V_{IN}(\max)} \quad (4)$$

Figure 7-2 shows the maximum recommended input voltage versus output voltage for each FSEL frequency. This graph uses a minimum on-time of 40ns and includes the 10% tolerance of the switching frequency. A minimum on-time of 40ns is used in this graph to provide margin to the minimum controllable on-time to make sure pulses are not skipped at no load. At light loads, the dead-time between the low-side MOSFET turning off and high-side MOSFET turning on contributes to the minimum SW node pulse-width.

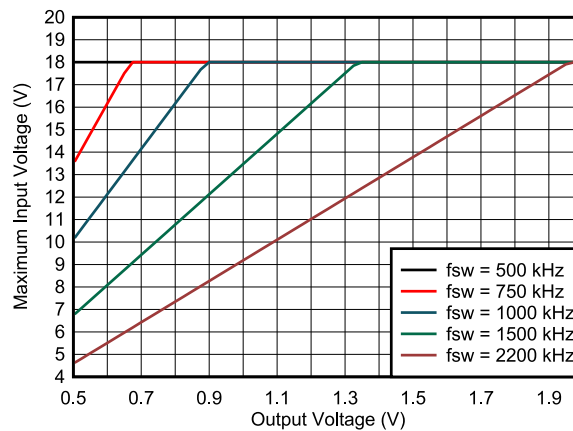

Figure 7-2. Maximum Input Voltage vs Output Voltage

In high output voltage applications, the minimum off-time must also be considered when selecting the switching frequency. When hitting the minimum off-time limits, the operating duty cycle maxes out and the output voltage begins to drop with the input voltage. Equation 5 calculates the maximum switching frequency to avoid this limit. This equation requires the DC resistance of the inductor, R_{DCR} , selected in the following step. A preliminary estimate of 10m Ω can be used but this must be recalculated based on the specifications of the inductor selected. If operating near the maximum f_{SW} limited by the minimum off-time, the increase in resistance at higher temperature must be considered.

$$f_{SW}(\max) = \frac{V_{IN}(\min) - V_{OUT} - I_{OUT}(\max) \times (R_{DCR} + R_{DS(ON)_HS})}{t_{OFF_MIN}(\max) \times (V_{IN}(\min) - I_{OUT}(\max) \times (R_{DS(ON)_HS} - R_{DS(ON)_LS}))} \quad (5)$$

7.2.1.2.2 Output Inductor Selection

An optimized 470nF inductor is integrated inside the module.

7.2.1.2.3 Output Capacitor

The output voltage ripple and how the regulator responds to a large change in load current are the two primary considerations for selecting the value of the output capacitor. The output capacitance must be selected based on the more stringent of these criteria.

The desired response to a large change in the load current is the first criteria and is typically the most stringent. A regulator does not respond immediately to a large, fast increase or decrease in load current. The output capacitor supplies or absorbs charge until the regulator responds to the load step. The control loop must sense the change in the output voltage then adjust the peak switch current in response to the change in load. The minimum output capacitance is selected based on an estimate of the loop bandwidth. Typically the loop bandwidth is near $f_{SW} / 10$. Equation 6 estimates the minimum output capacitance necessary, where ΔI_{OUT} is the change in output current and ΔV_{OUT} is the allowable change in the output voltage.

For this example, the transient load response is specified as a 3% change in V_{OUT} for a load step of 3A. Therefore, ΔI_{OUT} is 3A and ΔV_{OUT} is 30mV. Using this target gives a minimum capacitance of 159 μ F. This value does not take the ESR of the output capacitor into account in the output voltage change. For ceramic capacitors, the effect of the ESR can be small enough to be ignored. Aluminum electrolytic and tantalum capacitors have higher ESR that must be considered for load step response.

$$C_{OUT} > \frac{\Delta I_{OUT}}{\Delta V_{OUT}} \times \frac{1}{2\pi \times \frac{f_{SW}}{10}} \quad (6)$$

In addition to the loop bandwidth, the inductor current slew rate limiting how quickly the regulator responds to the load step is possible. For low duty cycle applications, the time the inductor current takes to ramp down after a load step down can be the limiting factor. Equation 7 estimates the minimum output capacitance necessary to limit the change in the output voltage after a load step down. Using the 0.47 μ H inductance selected gives a minimum capacitance of 70.5 μ F.

$$C_{OUT} > \frac{L_{OUT} \times \Delta I_{OUT}^2}{2 \times \Delta V_{OUT} \times V_{OUT}} \quad (7)$$

Equation 8 calculates the minimum output capacitance needed to meet the output voltage ripple specification. In this case, the target maximum steady state output voltage ripple is 10mV. Under this requirement, Equation 8 yields 30 μ F.

$$C_o > \frac{1}{8 \times f_{sw}} \times \frac{1}{\frac{V_{ripple}}{I_{ripple}}} \quad (8)$$

where

- ΔI_{OUT} is the change in output current
- ΔV_{OUT} is the allowable change in the output voltage
- f_{sw} is the regulators switching frequency
- V_{ripple} is the maximum allowable steady state output voltage ripple
- I_{ripple} is the inductor ripple current

Lastly, if an application does not have a strict load transient response or output ripple requirement, a minimum amount of capacitance is still required to make sure the control loop is stable with the lowest gain ramp setting on the MODE pin. Equation 9 estimates the minimum capacitance needed for loop stability. This equation sets

the minimum amount of capacitance by keeping the LC frequency relative to the switching frequency at a minimum value. See [Figure 7-3](#) for the limit versus output voltage with the lowest gain ramp setting of 1pF. With a 1V output, the minimum ratio is 35 and with this ratio, [Equation 9](#) gives a minimum capacitance of 66 μF .

$$C_{\text{OUT}} > \left(\frac{\text{Ratio}}{2\pi \times f_{\text{SW}}} \right)^2 \times \frac{1}{L_{\text{OUT}}} \quad (9)$$

[Equation 10](#) calculates the maximum combined ESR the output capacitors can have to meet the output voltage ripple specification and this shows the ESR must be less than 6m Ω . In this case, ceramic capacitors are used and the combined ESR of the ceramic capacitors in parallel is much less than is needed to meet the ripple. Capacitors also have limits to the amount of ripple current capacitors can handle without producing excess heat and failing. An output capacitor that can support the inductor ripple current must be specified. The capacitor data sheet specifies the RMS value of the maximum ripple current. [Equation 11](#) can be used to calculate the RMS ripple current the output capacitor needs to support. For this application, [Equation 11](#) yields 580mA and ceramic capacitors typically have a ripple current rating much higher than this.

$$\text{Resr} < \frac{V_{\text{ripple}}}{I_{\text{ripple}}} \quad (10)$$

$$I_{\text{corms}} = \frac{V_{\text{out}} \times (V_{\text{inmax}} - V_{\text{out}})}{\sqrt{12} \times V_{\text{inmax}} \times L1 \times f_{\text{sw}}} \quad (11)$$

Select X5R and X7R ceramic dielectrics or equivalent for power regulator capacitors because they have a high capacitance-to-volume ratio and are fairly stable over temperature. The output capacitor must also be selected with the DC bias and AC voltage derating taken into account. The derated capacitance value of a ceramic capacitor due to DC voltage bias and AC RMS voltage is usually found on the capacitor manufacturer website. For this application example, one 47 μF , 10V, X5R, 0805 and three 100 μF , 10V, X5R, 1206 ceramic capacitors each with 2m Ω of ESR are used. The one 47 μF capacitor is used because the 47 μF capacitor has a higher resonance frequency and can help reduce the output ripple caused by parasitic inductance. With the four parallel capacitors, the estimated effective output capacitance after derating using the capacitor manufacturer website is 327 μF . There is about a -7% DC bias derating at 1V. This design was able to use less than the calculated minimum because the loop crossover frequency was above the $f_{\text{SW}} / 10$ estimate as shown in the Load Transient graph in the *Application Curves*.

7.2.1.2.4 Input Capacitor

Input decoupling ceramic capacitors type X5R, X7R, or similar from VIN to PGND that are placed as close as possible to the IC are required. A total of at least 10µF of capacitance is required and some applications can require a bulk capacitance. TI recommends at least 1µF of bypass capacitance as close as possible to the VIN pin to minimize the input voltage ripple. A 0.1µF to 1-µF capacitor must be placed as close as possible to VIN pin 10 on the same side of the board of the device to provide high frequency bypass to reduce the high frequency overshoot and undershoot on VIN and SW pins. The voltage rating of the input capacitor must be greater than the maximum input voltage. The capacitor must also have a ripple current rating greater than the maximum RMS input current. The RMS input current can be calculated using [Equation 12](#).

For this example design, a ceramic capacitor with at least a 16V voltage rating is required to support the maximum input voltage. Three 10µF, 0805, X7S, 25V and one 0.1µF, 0402, X7R 25-V capacitors in parallel have been selected to be placed the sides of the IC near the VIN and PGND pins. Based on the capacitor manufacturer website, the total ceramic input capacitance derates to 8µF at the nominal input voltage of 12V. A 100µF bulk capacitance is also used to bypass long leads when connected a lab bench top power supply.

The input capacitance value determines the input ripple voltage of the regulator. The input voltage ripple can be calculated using [Equation 13](#). The maximum input ripple occurs when operating nearest to 50% duty cycle. Using the nominal design example values of $I_{outmax} = 6A$, $C_{IN} = 8\mu F$, and $f_{SW} = 1000kHz$, the input voltage ripple with the 12V nominal input is 57mV and the RMS input ripple current with the 4V minimum input is 5.2A.

$$I_{cirms} = I_{out} \times \sqrt{\frac{V_{out}}{V_{inmin}} \times \frac{(V_{inmin} - V_{out})}{V_{inmin}}} \quad (12)$$

$$\Delta V_{in} = \frac{I_{outmax} \times \left(1 - \frac{V_{out}}{V_{in}}\right) \times \frac{V_{out}}{V_{in}}}{C_{in} \times f_{SW}} \quad (13)$$

7.2.1.2.5 Adjustable Undervoltage Lockout

The undervoltage lockout (UVLO) is adjusted using the external voltage divider network of R_{ENT} and R_{ENB} . The UVLO has two thresholds: one for power up when the input voltage is rising and one for power down or brownouts when the input voltage is falling. For the example design, the supply is set to turn on and start switching after the input voltage increases above 4V (UVLO start or enable). After the regulator starts switching, the regulator continues to do so until the input voltage falls below 3.95V (UVLO stop or disable). In this example, these start and stop voltages set by the EN resistor divider were selected to have more hysteresis than the internally fixed VIN UVLO.

[Equation 1](#) and [Equation 2](#) can be used to calculate the values for the upper and lower resistor values. For these equations to work, V_{START} must be $1.1 \times V_{STOP}$ due to the EN pin voltage hysteresis. For the voltages specified, the standard resistor value used for R_{ENT} is 16.9kΩ and for R_{ENB} is 6.04kΩ.

7.2.1.2.6 Output Voltage Resistors Selection

The output voltage is set with a resistor divider created by R_{FBT} and R_{FBB} from the output node to the FB pin. TI recommends to use 1% tolerance or better resistors. For this example design, 10k Ω was selected for R_{FBB} . Using Equation 14, R_{FBT} is calculated as 10 k Ω . This is a standard 1% resistor.

$$R_{FBT} = R_{FBB} \times \left(\frac{V_{OUT}}{V_{REF}} - 1 \right) \quad (14)$$

If the PCB layout does not use the recommended AGND to PGND connection in Section 7.4.1, noise on the feedback pin can degrade the output voltage regulation at maximum load. Using a smaller R_{FBB} of 1.00k Ω minimizes the impact of this noise.

7.2.1.2.7 Bootstrap Capacitor Selection

A 0.1 μ F ceramic capacitor is integrated inside the module connected between the BOOT and SW pin.

7.2.1.2.8 BP5 Capacitor Selection

A 2.2 μ F ceramic capacitor must be connected between the BP5 pin and AGND for proper operation. The capacitor must be rated for at least 10V to minimize DC bias derating.

7.2.1.2.9 PGOOD Pullup Resistor

A 10k Ω resistor is used to pull up the power good signal when FB conditions are met. The pullup voltage source must be less than the 6V absolute maximum of the PGOOD pin.

7.2.1.2.10 Current Limit Selection

The MODE pin is used to select between two current limit settings. Select the current limit setting whose minimum is greater than at least 1.1 times the maximum steady state peak current. This selection is to provide margin for component tolerance and load transients. For this design, the minimum current limit must be greater than 7.45A so the high current limit setting is selected.

7.2.1.2.11 Soft-Start Time Selection

The MODE pin is used to select between four different soft-start times. This selection is useful if a load has specific timing requirements for the output voltage of the regulator. A longer soft-start time is also useful if the output capacitance is very large and requires large amounts of current to quickly charge the output capacitors to the output voltage level. The large currents necessary to charge the capacitor can reach the current limit or cause the input voltage rail to sag due excessive current draw from the input power supply. Limiting the output voltage slew rate solves both of these problems. The example design has the soft-start time set to 1.0ms. With this soft-start time the current required to charge the output capacitors to the nominal output voltage is only 0.14A.

7.2.1.2.12 Ramp Selection and Control Loop Stability

The MODE pin is used to select between three different ramp settings. The most optimal ramp setting depends on V_{OUT} , f_{SW} , L_{OUT} , and C_{OUT} . To get started, calculate LC double pole frequency using Equation 15. The ratio between f_{SW} and f_{LC} must then be calculated. Based on this ratio and the output voltage, the recommended ramp setting must be selected using Figure 7-3. With a 1V output, TI recommends the 1pF ramp for ratios between approximately 35 and 58, TI recommends the 2pF ramp for ratios between approximately 58 and 86, and TI recommends the 4pF ramp for ratios greater than approximately 86. In general, use the largest ramp capacitor the design supports. Increasing the ramp capacitor improves transient response but can reduce stability margin or increase on-time jitter.

For this design, f_{LC} is 12.5kHz and the ratio is 80 which is on the border of the 2pF and 4pF ramp settings. Through bench evaluation, the design having sufficient stability margin with the 2pF ramp was discovered, so this setting was selected for the best transient response. The recommended ramp settings given by Figure 7-3 include margin to account for potential component tolerances and variations across operating conditions, using a higher ramp setting as shown in this example is possible.

$$f_{LC} = \frac{1}{2 \times \pi \times \sqrt{L_{OUT} \times C_{OUT}}} \quad (15)$$

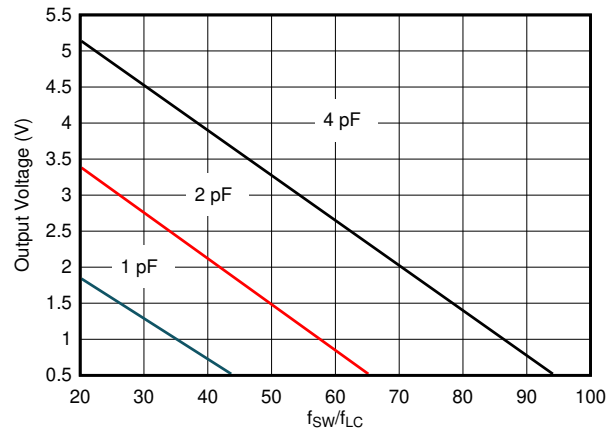

Figure 7-3. Recommended Ramp Settings

Use a feedforward capacitor (C_{FF}) in parallel with the upper feedback resistor (R_{FBT}) to add a zero into the control loop to provide phase boost. Include a placeholder for this capacitor as the zero this capacitor provides can be required to meet phase margin requirements. This capacitor also adds a pole at a higher frequency than the zero. The pole and zero frequency are not independent so as a result, after the zero location is chosen, the pole is fixed as well. The zero is placed at 1/4 the f_{SW} by calculating the value of C_{FF} with Equation 16. The calculated value is 64pF.

Using bench measurements of the AC response, the feedforward capacitor for this example design was increased to 100pF to improve the transient response.

$$C_{FF} = \frac{1}{\pi \times R_{FBT} \times \frac{f_{SW}}{2}} \quad (16)$$

Using larger feedforward capacitors to further improve the transient response but take care to make sure there is a minimum of –9dB gain margin in all operating conditions is possible. The feedforward capacitor injects noise on the output into the FB pin. This added noise can result in increased on-time jitter at the switching node. Too little gain margin can cause a repeated wide and narrow pulse behavior. Adding a 499Ω resistor in series with the feedforward capacitor can help reduce the impact of noise on the FB pin in case of non-ideal PCB layout. The value of this resistor must be kept small as larger values bring the feedforward pole and zero closer together degrading the phase boost the feedforward capacitor provides.

When using higher ESR output capacitors, such as polymer or tantalum, the ESR zero (f_{ESR}) must be accounted for. The ESR zero can be calculated using [Equation 17](#). If the ESR zero frequency is less than the estimated bandwidth of 1/10th the f_{SW} , the gain margin and phase margin are affected. A series R-C from the FB pin to ground can be used to add a pole into the control loop if necessary. All ceramic capacitors are used in this design so the effect of the ESR zero is ignored.

$$f_{\text{ESR}} = \frac{1}{2 \times \pi \times C_{\text{OUT}} \times R_{\text{ESR}}} \quad (17)$$

7.2.1.2.13 MODE Pin

The MODE resistor is set to 4.87kΩ to select the high current limit setting, 1.0ms soft start and the 2pF ramp. See [Table 6-4](#) for the full list of the MODE pin settings.

7.2.1.3 Application Curves

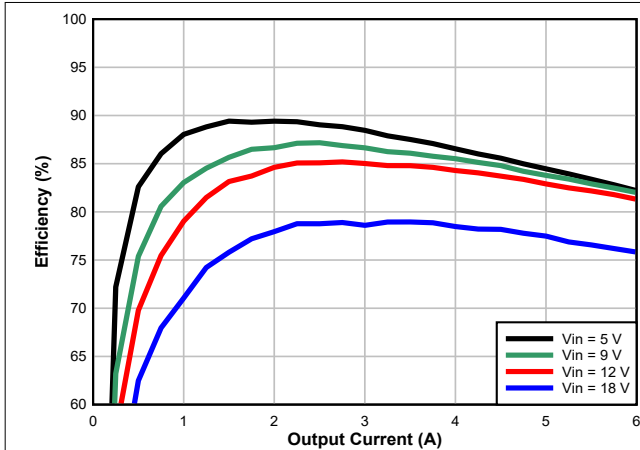

Figure 7-4. Efficiency

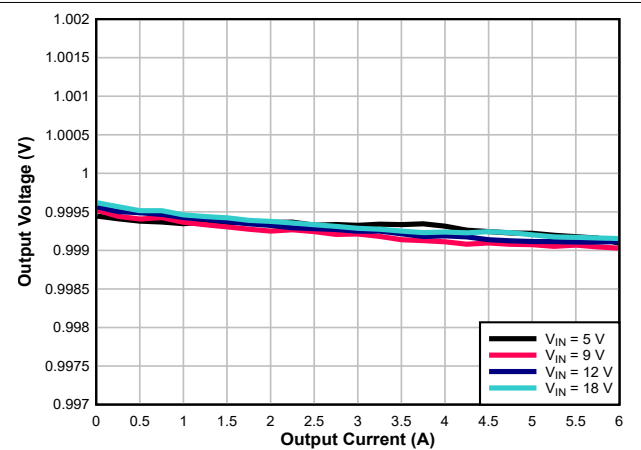

Figure 7-5. Load Regulation

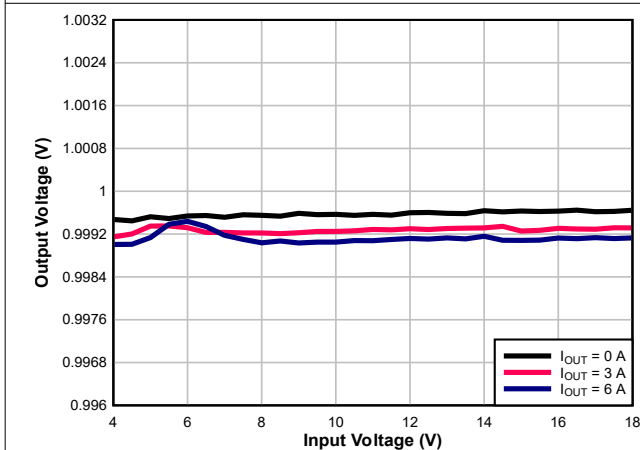
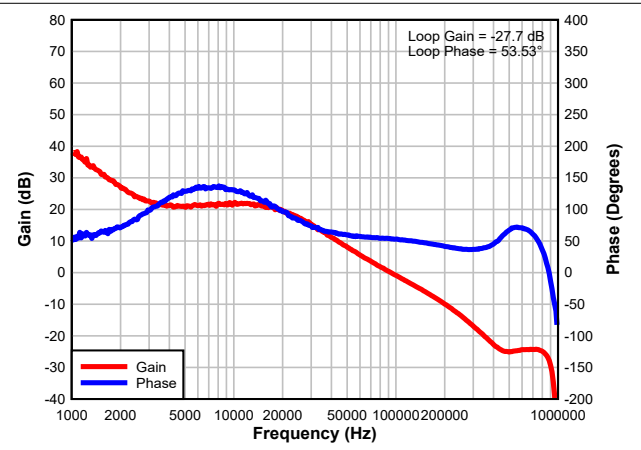
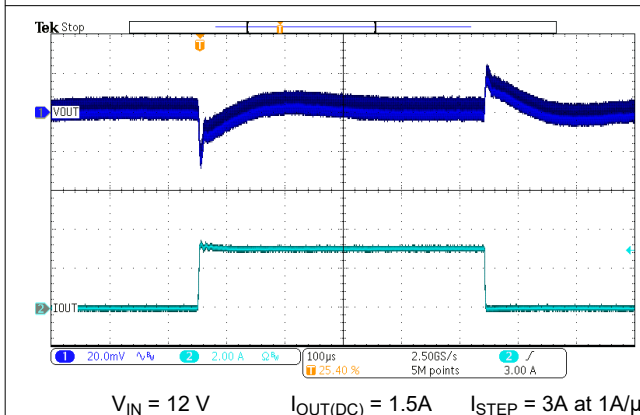

Figure 7-6. Line Regulation



$V_{IN} = 12\text{ V}$ $I_{OUT} = 6\text{ A}$

Figure 7-7. Bode Plot



$V_{IN} = 12\text{ V}$ $I_{OUT(DC)} = 1.5\text{ A}$ $I_{STEP} = 3\text{ A at } 1\text{ A}/\mu\text{ s}$

Figure 7-8. Load Transient

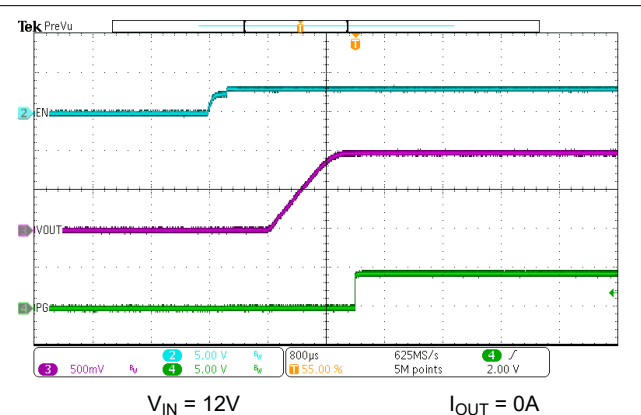

$V_{IN} = 12\text{ V}$ $I_{OUT} = 0\text{ A}$

Figure 7-9. EN Start-Up – No Load

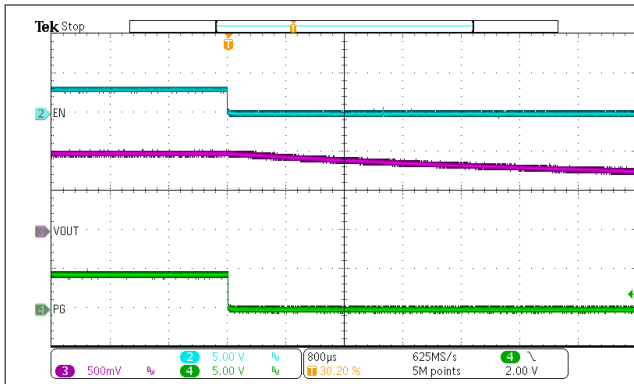

$V_{IN} = 12V$ $I_{OUT} = 0A$

Figure 7-10. EN Shutdown No Load

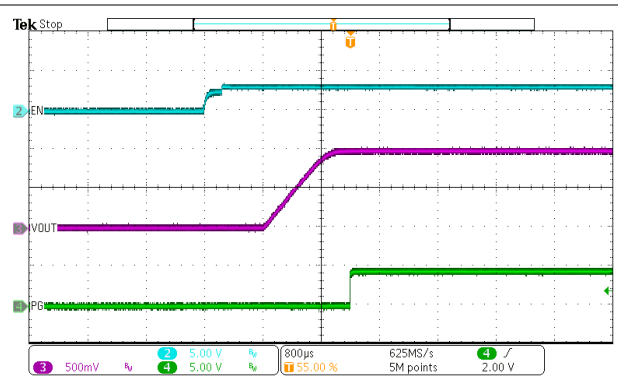

$V_{IN} = 12V$ $I_{OUT} = 6A$

Figure 7-11. EN Start-Up – With Load

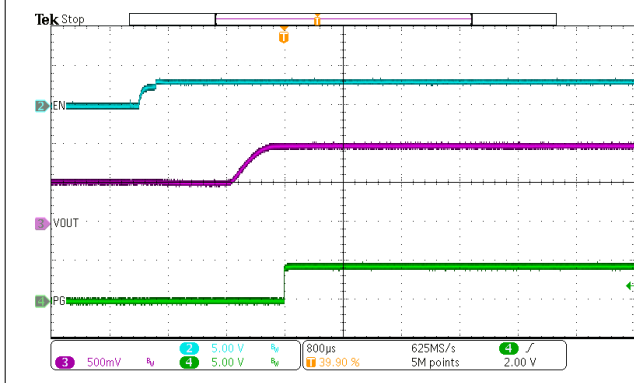

$V_{IN} = 12V$ $I_{OUT} = 0A$

Figure 7-12. EN Start-Up – 0.5V Prebias

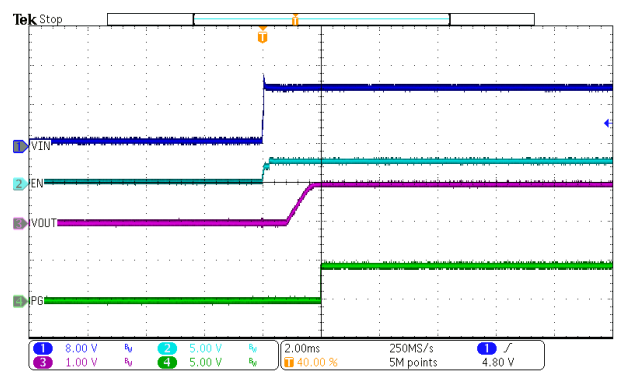

$I_{OUT} = 0A$

Figure 7-13. VIN Start-Up

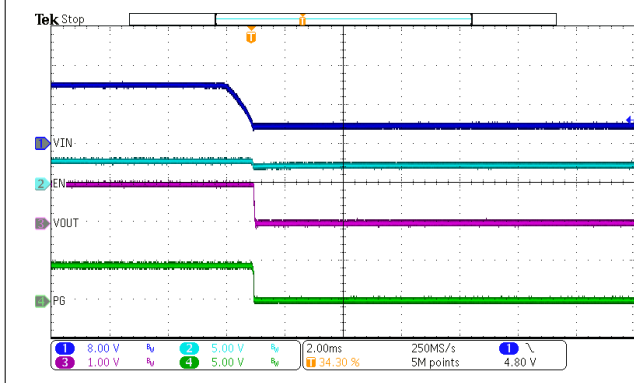

$I_{OUT} = 6A$

Figure 7-14. VIN Shutdown

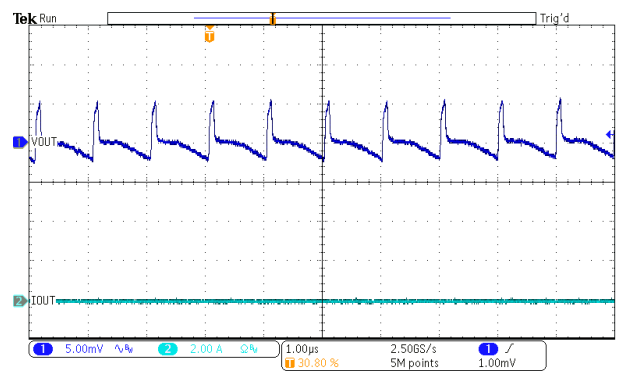

$V_{IN} = 12V$ $I_{OUT} = 0A$

Figure 7-15. Output Ripple – No Load

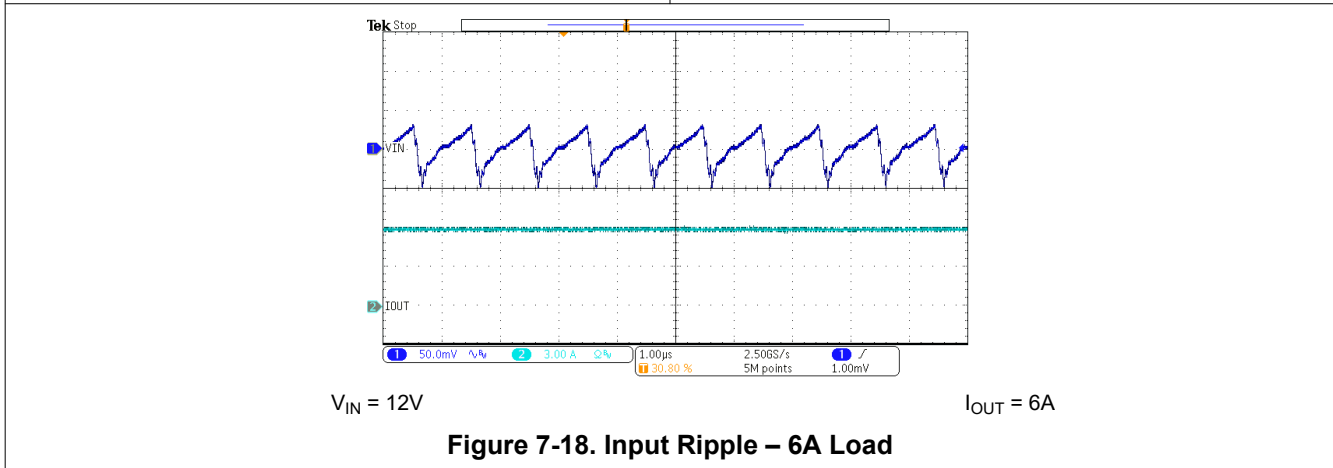
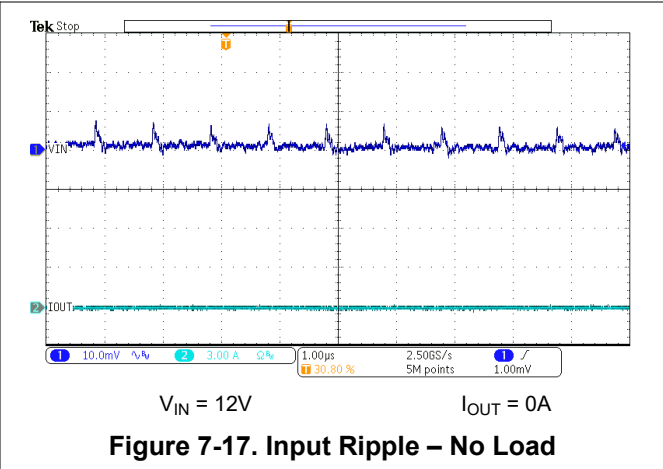
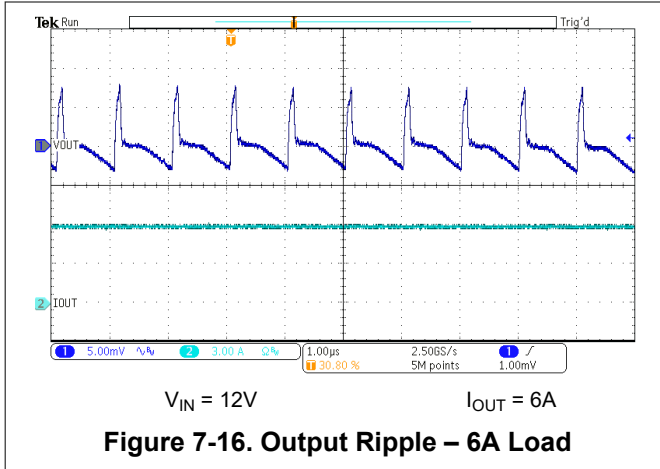

7.3 Power Supply Recommendations

The TPSM843620 is designed to operate from an input voltage supply range between 4V and 18V. This supply voltage must be well regulated. Proper bypassing of the input supply is critical for proper electrical performance, as is the PCB layout and the grounding scheme. A minimum of 4 μ F (after derating) ceramic capacitance, type X5R or better, must be placed near the device. TI recommends splitting the ceramic input capacitance equally between the VIN and PGND pins on each side of the device resulting in at least 2 μ F of ceramic capacitance on each side of the device.

7.4 Layout

7.4.1 Layout Guidelines

Layout is a critical portion of good power supply design. See [Figure 7-19](#) for a PCB layout example. Key guidelines to follow for the layout are:

- Make VIN, PGND, and SW traces as wide as possible to reduce trace impedance and improve heat dissipation.
- Place a 10nF to 100nF capacitor at the VIN pin to PGND as close as possible to the device on the same side of the PCB. Place the remaining ceramic input capacitance next to these high frequency bypass capacitors. The remaining input capacitance can be placed on the other side of the board but use as many vias as possible to minimize impedance between the capacitors and the pins of the IC.
- Use multiple vias near the PGND pins and use the layer directly below the device to connect them together. This action helps to minimize noise and can help heat dissipation.
- Use vias near the VIN pin and provide a low impedance connection between them through an internal layer.
- Place the BP5 capacitor as close as possible to the BP5 and AGND pins.

- Place the bottom resistor in the FB divider as close as possible to the FB and AGND pins of the IC. Also keep the upper feedback resistor and the feedforward capacitor near the IC. Connect the FB divider to the output voltage at the desired point of regulation.
- Use multiple vias in the AGND island to connect back to internal PGND layers. Do not place these vias between the BP5 capacitor and the AGND pin. These vias conduct switching currents between the BP5 capacitor and PGND. Placing the vias near the AGND pin can add noise to the FB divider.
- Return the FSEL and MODE resistors to a quiet AGND island.

7.4.2 Layout Example

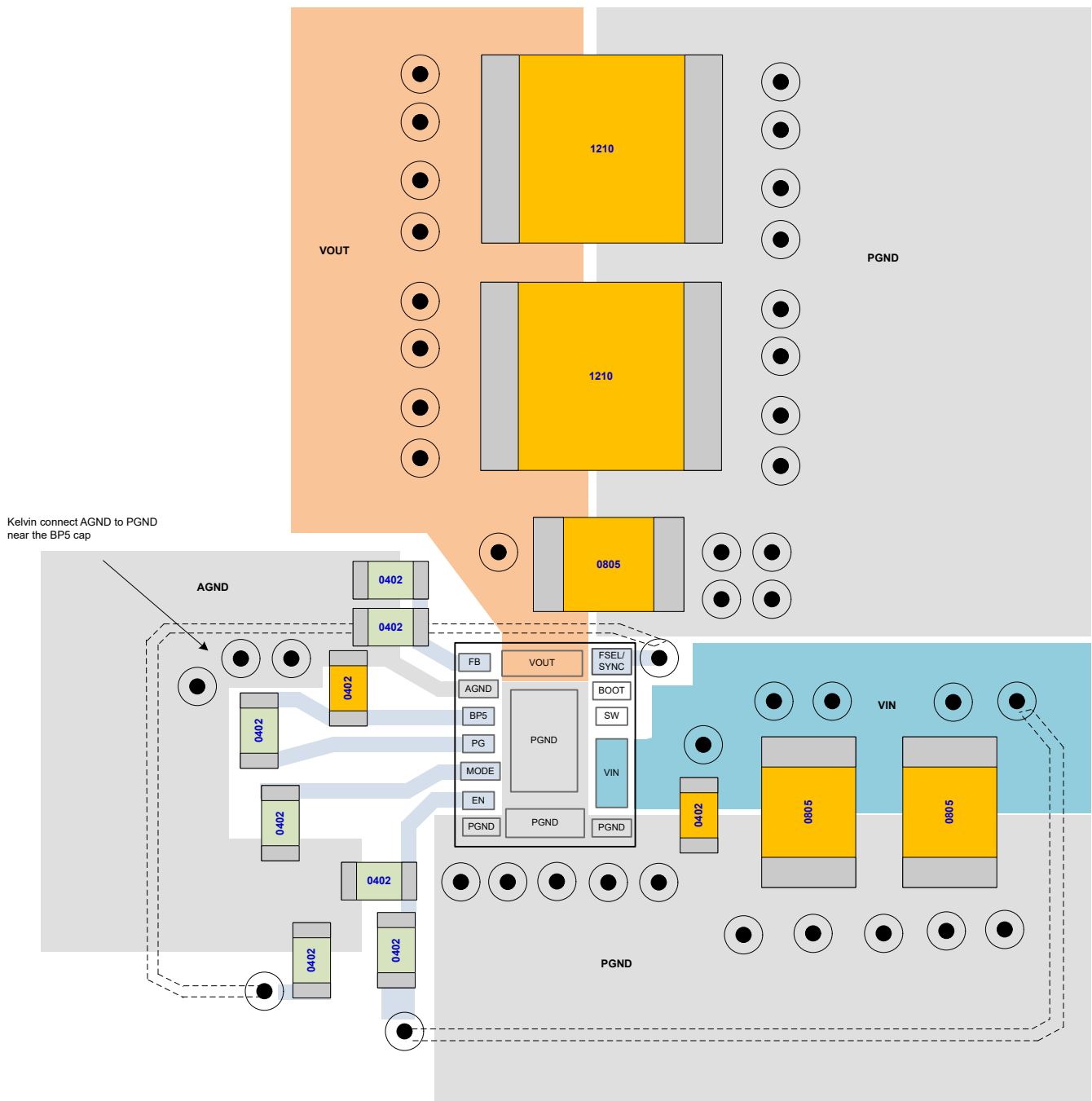

Figure 7-19. Example PCB Layout

7.4.2.1 Thermal Performance

Test Conditions: $f_{SW} = 1\text{MHz}$, $V_{in} = 12\text{V}$, $V_{out} = 1\text{V}$, $I_{out} = 6\text{A}$, Ambient temperature = 25°C

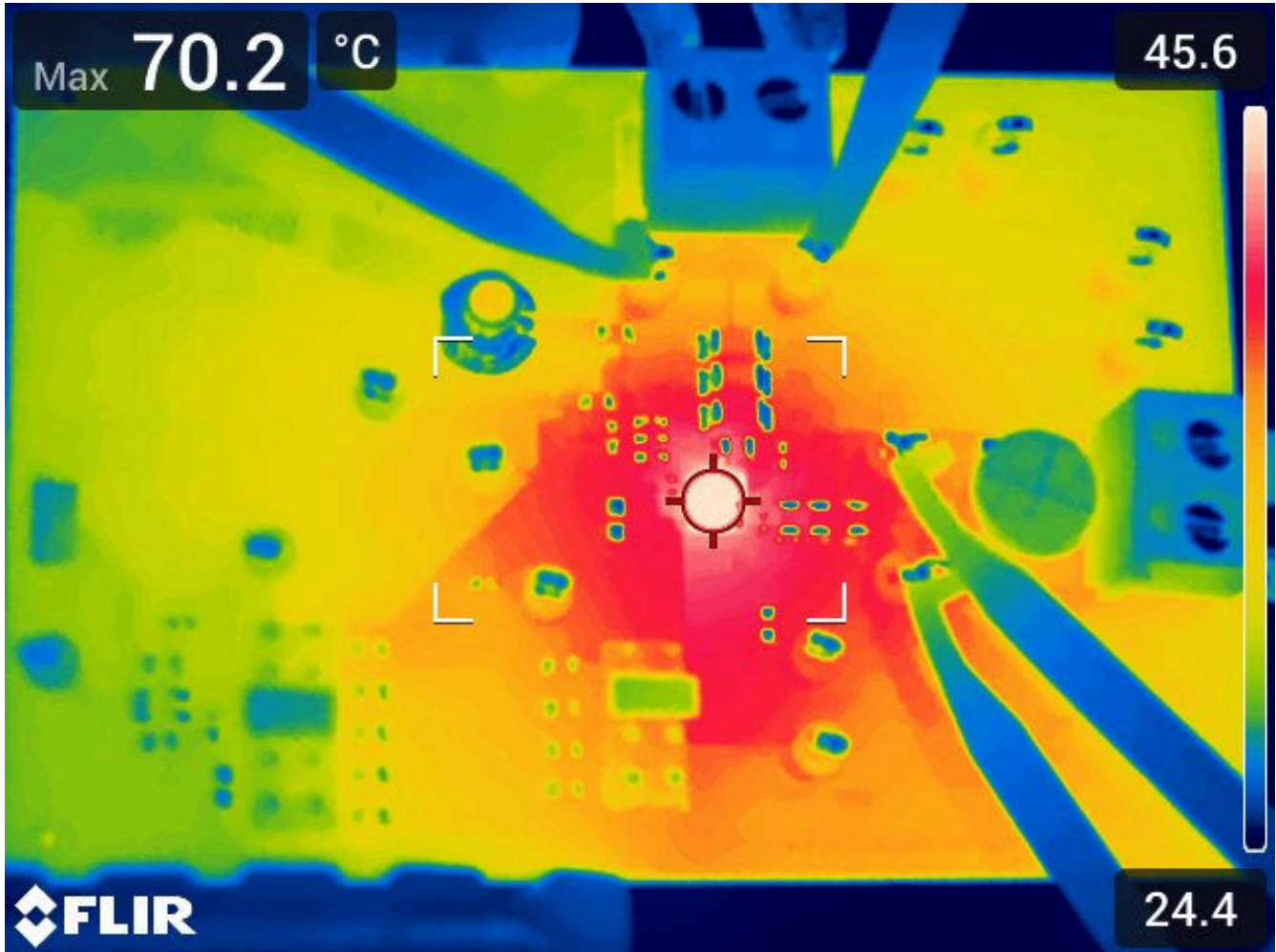

Figure 7-20. Thermal Image at 25°C Ambient

8 Device and Documentation Support

8.1 Receiving Notification of Documentation Updates

To receive notification of documentation updates, navigate to the device product folder on ti.com. Click on *Notifications* to register and receive a weekly digest of any product information that has changed. For change details, review the revision history included in any revised document.

8.2 Support Resources

[TI E2E™ support forums](#) are an engineer's go-to source for fast, verified answers and design help — straight from the experts. Search existing answers or ask your own question to get the quick design help you need.

Linked content is provided "AS IS" by the respective contributors. They do not constitute TI specifications and do not necessarily reflect TI's views; see TI's [Terms of Use](#).

8.3 Trademarks

MicroSiP™ and TI E2E™ are trademarks of Texas Instruments. All trademarks are the property of their respective owners.

8.4 Electrostatic Discharge Caution



This integrated circuit can be damaged by ESD. Texas Instruments recommends that all integrated circuits be handled with appropriate precautions. Failure to observe proper handling and installation procedures can cause damage.

ESD damage can range from subtle performance degradation to complete device failure. Precision integrated circuits may be more susceptible to damage because very small parametric changes could cause the device not to meet its published specifications.

8.5 Glossary

[TI Glossary](#) This glossary lists and explains terms, acronyms, and definitions.

9 Revision History

NOTE: Page numbers for previous revisions may differ from page numbers in the current version.

Changes from Revision A (December 2023) to Revision B (June 2024)	Page
--	-------------

- Updated the document title..... 1

Changes from Revision * (October 2023) to Revision A (December 2023)	Page
---	-------------

- Changed document status from Advance Information to Production Data..... 1

10 Mechanical, Packaging, and Orderable Information

The following pages include mechanical, packaging, and orderable information. This information is the most current data available for the designated devices. This data is subject to change without notice and revision of this document. For browser-based versions of this data sheet, refer to the left-hand navigation.

PACKAGING INFORMATION

Orderable part number	Status (1)	Material type (2)	Package Pins	Package qty Carrier	RoHS (3)	Lead finish/ Ball material (4)	MSL rating/ Peak reflow (5)	Op temp (°C)	Part marking (6)
TPSM843620SITR	Active	Production	uSiP (SIT) 15	3000 LARGE T&R	Yes	ENEPIG	Level-2-260C-1 YEAR	-40 to 125	T43620
TPSM843620SITR.A	Active	Production	uSiP (SIT) 15	3000 LARGE T&R	Yes	ENEPIG	Level-2-260C-1 YEAR	-40 to 125	T43620
TPSM843620SITR.B	Active	Production	uSiP (SIT) 15	3000 LARGE T&R	Yes	ENEPIG	Level-2-260C-1 YEAR	-40 to 125	T43620

(1) **Status:** For more details on status, see our [product life cycle](#).

(2) **Material type:** When designated, preproduction parts are prototypes/experimental devices, and are not yet approved or released for full production. Testing and final process, including without limitation quality assurance, reliability performance testing, and/or process qualification, may not yet be complete, and this item is subject to further changes or possible discontinuation. If available for ordering, purchases will be subject to an additional waiver at checkout, and are intended for early internal evaluation purposes only. These items are sold without warranties of any kind.

(3) **RoHS values:** Yes, No, RoHS Exempt. See the [TI RoHS Statement](#) for additional information and value definition.

(4) **Lead finish/Ball material:** Parts may have multiple material finish options. Finish options are separated by a vertical ruled line. Lead finish/Ball material values may wrap to two lines if the finish value exceeds the maximum column width.

(5) **MSL rating/Peak reflow:** The moisture sensitivity level ratings and peak solder (reflow) temperatures. In the event that a part has multiple moisture sensitivity ratings, only the lowest level per JEDEC standards is shown. Refer to the shipping label for the actual reflow temperature that will be used to mount the part to the printed circuit board.

(6) **Part marking:** There may be an additional marking, which relates to the logo, the lot trace code information, or the environmental category of the part.

Multiple part markings will be inside parentheses. Only one part marking contained in parentheses and separated by a "-" will appear on a part. If a line is indented then it is a continuation of the previous line and the two combined represent the entire part marking for that device.

Important Information and Disclaimer: The information provided on this page represents TI's knowledge and belief as of the date that it is provided. TI bases its knowledge and belief on information provided by third parties, and makes no representation or warranty as to the accuracy of such information. Efforts are underway to better integrate information from third parties. TI has taken and continues to take reasonable steps to provide representative and accurate information but may not have conducted destructive testing or chemical analysis on incoming materials and chemicals. TI and TI suppliers consider certain information to be proprietary, and thus CAS numbers and other limited information may not be available for release.

In no event shall TI's liability arising out of such information exceed the total purchase price of the TI part(s) at issue in this document sold by TI to Customer on an annual basis.

TAPE AND REEL INFORMATION

QUADRANT ASSIGNMENTS FOR PIN 1 ORIENTATION IN TAPE

*All dimensions are nominal

Device	Package Type	Package Drawing	Pins	SPQ	Reel Diameter (mm)	Reel Width W1 (mm)	A0 (mm)	B0 (mm)	K0 (mm)	P1 (mm)	W (mm)	Pin1 Quadrant
TPSM843620SITR	uSiP	SIT	15	3000	330.0	12.4	3.75	3.75	2.2	8.0	12.0	Q1

TAPE AND REEL BOX DIMENSIONS

*All dimensions are nominal

Device	Package Type	Package Drawing	Pins	SPQ	Length (mm)	Width (mm)	Height (mm)
TPSM843620SITR	uSiP	SIT	15	3000	383.0	353.0	58.0

EXAMPLE BOARD LAYOUT

SIT0015A

MicroSiP™ - 1.6 mm max height

MICRO SYSTEM IN PACKAGE

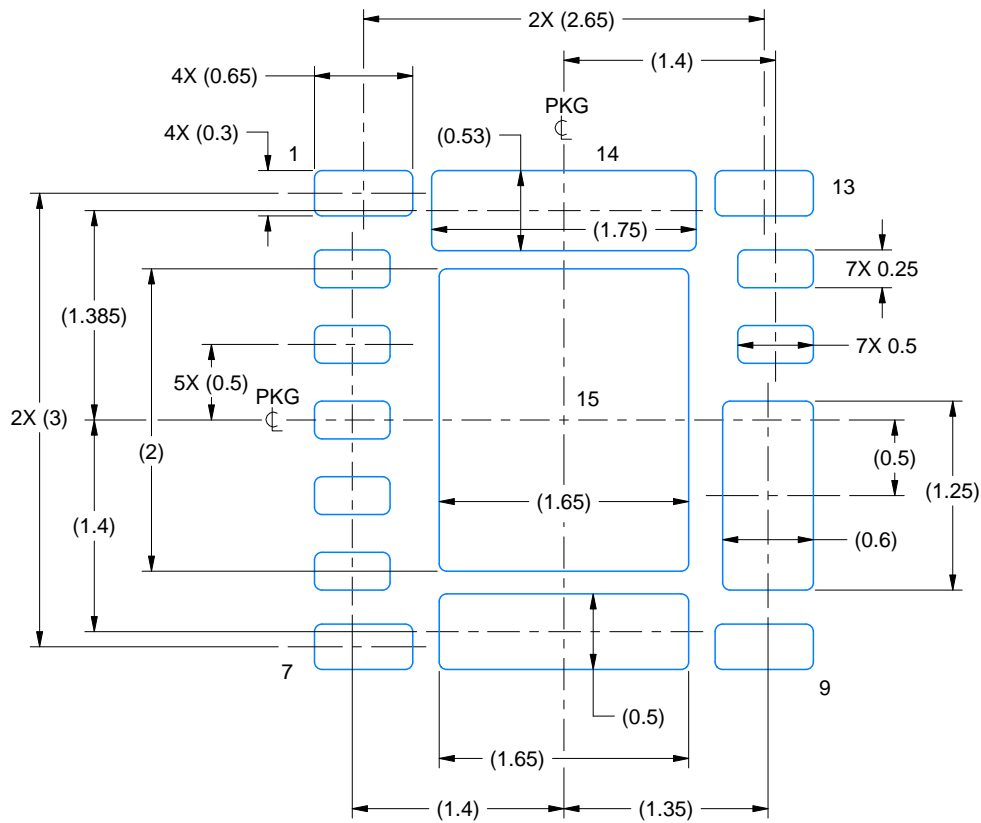

LAND PATTERN EXAMPLE
EXPOSED METAL SHOWN
SCALE: 20X

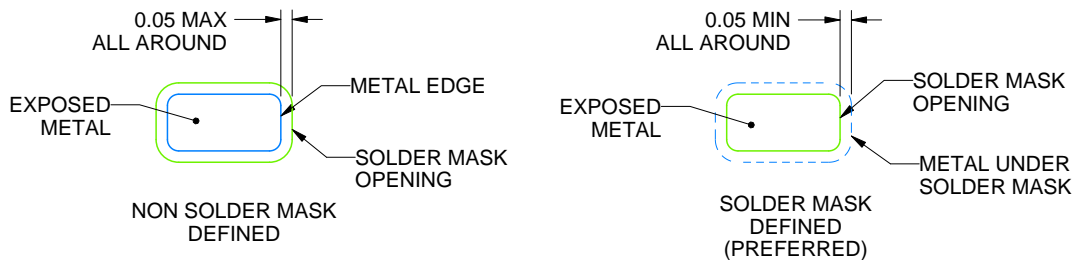

SOLDER MASK DETAILS
NOT TO SCALE

4228472/C 06/2023

NOTES: (continued)

4. This package is designed to be soldered to a thermal pad on the board. For more information, see Texas Instruments literature number SLUA271 (www.ti.com/lit/slua271).

EXAMPLE STENCIL DESIGN

SIT0015A

MicroSiP™ - 1.6 mm max height

MICRO SYSTEM IN PACKAGE

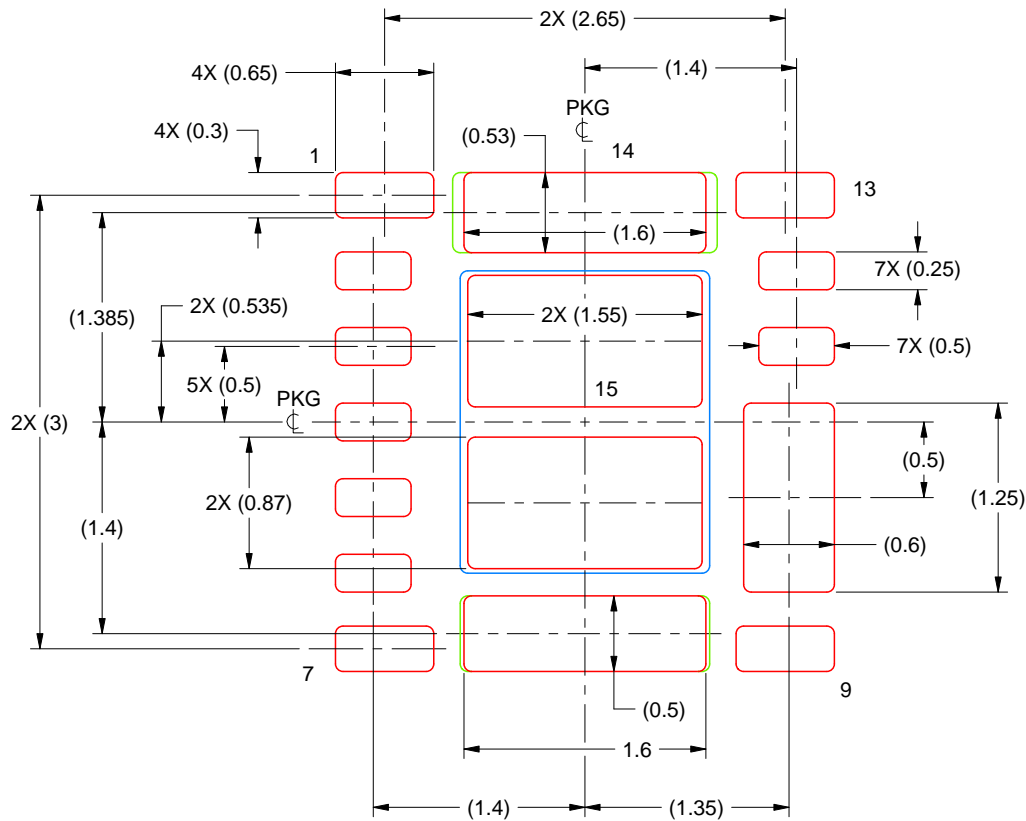

SOLDER PASTE EXAMPLE
 BASED ON 0.125 mm THICK STENCIL
 SCALE:20X

PRINTED SOLDER COVERAGE BY AREA UNDER PACKAGE
 PAD 8: 97%
 PAD 14: 91%
 PAD 15: 82%

4228472/C 06/2023

NOTES: (continued)

5. Laser cutting apertures with trapezoidal walls and rounded corners may offer better paste release. IPC-7525 may have alternate design recommendations.

IMPORTANT NOTICE AND DISCLAIMER

TI PROVIDES TECHNICAL AND RELIABILITY DATA (INCLUDING DATA SHEETS), DESIGN RESOURCES (INCLUDING REFERENCE DESIGNS), APPLICATION OR OTHER DESIGN ADVICE, WEB TOOLS, SAFETY INFORMATION, AND OTHER RESOURCES "AS IS" AND WITH ALL FAULTS, AND DISCLAIMS ALL WARRANTIES, EXPRESS AND IMPLIED, INCLUDING WITHOUT LIMITATION ANY IMPLIED WARRANTIES OF MERCHANTABILITY, FITNESS FOR A PARTICULAR PURPOSE OR NON-INFRINGEMENT OF THIRD PARTY INTELLECTUAL PROPERTY RIGHTS.

These resources are intended for skilled developers designing with TI products. You are solely responsible for (1) selecting the appropriate TI products for your application, (2) designing, validating and testing your application, and (3) ensuring your application meets applicable standards, and any other safety, security, regulatory or other requirements.

These resources are subject to change without notice. TI grants you permission to use these resources only for development of an application that uses the TI products described in the resource. Other reproduction and display of these resources is prohibited. No license is granted to any other TI intellectual property right or to any third party intellectual property right. TI disclaims responsibility for, and you will fully indemnify TI and its representatives against, any claims, damages, costs, losses, and liabilities arising out of your use of these resources.

TI's products are provided subject to [TI's Terms of Sale](#) or other applicable terms available either on [ti.com](https://www.ti.com) or provided in conjunction with such TI products. TI's provision of these resources does not expand or otherwise alter TI's applicable warranties or warranty disclaimers for TI products.

TI objects to and rejects any additional or different terms you may have proposed.

Mailing Address: Texas Instruments, Post Office Box 655303, Dallas, Texas 75265

Copyright © 2025, Texas Instruments Incorporated