

TRF1305C1 5dB-Gain, Single-Channel, DC to > 7GHz BW, RF Fully Differential Amp

1 Features

- Three performance-optimized power gain variants:
 - 15dB (TRF1305A1)
 - 10dB (TRF1305B1)
 - 5dB (TRF1305C1)
- Fixed gain can be reduced with external resistors
- Wide large-signal RF bandwidth:
 - D2D: 7.5GHz (3dB), 6.5GHz (1dB)
 - S2D: 8.3GHz (3dB), 7.5GHz (1dB)
- OP1dB (differential 100Ω load):
 - D2D: 15.2dBm (2GHz), 12.6dBm (4GHz)
 - S2D: 14.3dBm (2GHz), 11.3dBm (4GHz)
- OIP3 ($P_O = 1\text{dBm/tone}$):
 - D2D: 33.5dBm (2GHz), 25dBm (4GHz)
 - S2D: 32dBm (2GHz), 22dBm (4GHz)
- Noise Figure:
 - D2D: 13.7dB (2GHz), 17.1dB (4GHz)
 - S2D: 13.4dB (2GHz), 16.4dB (4GHz)
- Slew rate: 25kV/μs
- Large input ($\pm 1\text{V}$) and output ($\pm 0.5\text{V}$) common-mode voltage ranges
- Flexible configurations and modes:
 - Single-ended input, differential output (S2D)
 - Differential input, differential output (D2D)
 - AC- or DC-coupled input/output
 - Adjustable output common-mode voltage
 - Input common-mode range extension mode
- Supports 5V, single or split supplies
- Active power dissipation: 540mW
- Power-down mode

2 Applications

- RF sampling or GSPS ADC driver
- [Test and measurement](#)
- [Wireless communications test](#)
- [RF digitizers](#)
- [Oscilloscopes \(DSOs\)](#)
- [High speed digitizer](#)
- [Spectrum analyzer](#)

- [Vector signal transceiver \(VST\)](#)
- [Mass spectrometry systems](#)
- Common-mode level shifting
- IQ mixer interface

3 Description

The TRF1305C1 is a very-high-performance, closed-loop, single-channel RF amplifier that has an operational bandwidth from true dc to > 7GHz. The device has excellent performance to drive high-speed, high-performance ADCs, such as the [ADC12DJ5200RF](#) and [ADC32RF5x](#) with a dc- or ac-coupled interface. The amplifier is optimized for use in RF, zero and complex IF, and high-speed time-domain applications. The device is optimized for performance in the fixed gain configuration. If lower gain is desired, use external resistors.

The TRF1305C1 features a VOCM pin that allows setting different output common-mode and input common-mode voltages; for example, level-shifting or for most IQ down-converter ADC-interface applications that have differing dc common-mode voltages. The TRF1305C1 also features a floating two-rail split or single-supply option, and a MODE pin that allows extending the input common-mode range closer to the supplies. The device also has a power-down feature.

The device is fabricated with TI's proprietary advanced BiCMOS process and is available in a space-saving, 2mm × 2mm, WQFN-FCRLF package.

Device Information

PART NUMBER ⁽¹⁾	POWER GAIN	PACKAGE ⁽²⁾
TRF1305A1	15dB	RPV (WQFN-FCRLF, 12)
TRF1305B1	10dB	
TRF1305C1	5dB	

(1) See [Section 4](#).

(2) For more information, see [Section 11](#).

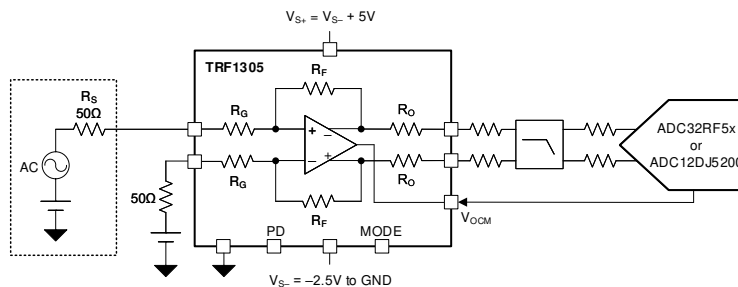

TRF1305C1 in S2D Configuration Driving a High-Speed ADC



Table of Contents

1 Features	1	7.1 Overview.....	27
2 Applications	1	7.2 Functional Block Diagram.....	27
3 Description	1	7.3 Feature Description.....	27
4 Device Comparison Table	2	7.4 Device Functional Modes.....	29
5 Pin Configuration and Functions	3	8 Application and Implementation	30
6 Specifications	4	8.1 Application Information.....	30
6.1 Absolute Maximum Ratings.....	4	8.2 Typical Application.....	32
6.2 ESD Ratings.....	4	8.3 Power Supply Recommendations.....	35
6.3 Recommended Operating Conditions.....	4	8.4 Layout.....	36
6.4 Thermal Information.....	4	9 Device and Documentation Support	37
6.5 Electrical Characteristics - AC Specifications in D2D Configuration.....	5	9.1 Documentation Support.....	37
6.6 Electrical Characteristics - AC Specifications in S2D Configuration.....	7	9.2 Receiving Notification of Documentation Updates... 37	37
6.7 Electrical Characteristics - DC and Timing Specifications.....	9	9.3 Support Resources.....	37
6.8 Typical Characteristics: D2D Configuration.....	10	9.4 Trademarks.....	37
6.9 Typical Characteristics: S2D Configuration	20	9.5 Electrostatic Discharge Caution.....	37
7 Detailed Description	27	9.6 Glossary.....	37
		10 Revision History	37
		11 Mechanical, Packaging, and Orderable Information	37

4 Device Comparison Table

DEVICE	GAIN	CHANNEL COUNT
TRF1305A1	15dB	1
TRF1305B1	10dB	
TRF1305C1	5dB	
TRF1305A2	15dB	2
TRF1305B2	10dB	
TRF1305C2	5dB	

5 Pin Configuration and Functions

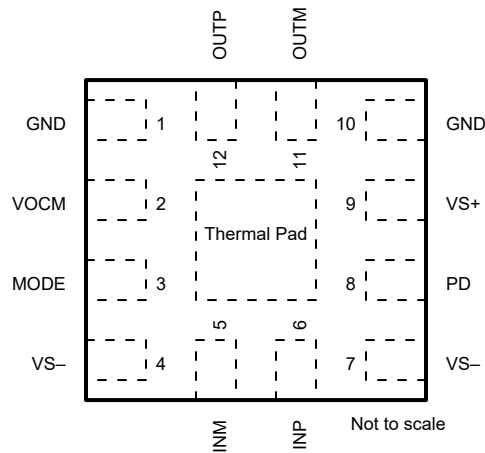

Figure 5-1. RPV Package, 12-Pin WQFN-FCRLF (Top View)

Table 5-1. Pin Functions

PIN		TYPE	DESCRIPTION
NAME	NO.		
GND	1, 10	Ground	Ground. Reference for RF signals and PD control signal. Connect to ground plane on the board. Internally shorted to the thermal pad.
INM	5	Input	Negative side of differential input signal
INP	6	Input	Positive side of differential input signal
MODE	3	Input	Mode selection pin. See also Section 7.4.1 .
OUTM	11	Output	Negative side of differential output signal
OUTP	12	Output	Positive side of differential output signal
PD	8	Input	Power-down signal, referenced to GND. Supports both 1.8V and 3.3V logic. Logic 0 or open = device enabled. Logic 1 = device powered down.
VOVM	2	Input	Output common-mode voltage input pin. Floating the pin sets the output common-mode voltage to $V_{S-} + 2.5V$.
VS-	4, 7	Power	Negative supply voltage
VS+	9	Power	Positive supply voltage
Thermal Pad	Pad	Ground	Thermal pad. Connect to heat-dissipating ground plane on the board. Internally shorted to GND.

6 Specifications

6.1 Absolute Maximum Ratings

over operating free-air temperature range (unless otherwise noted)⁽¹⁾

		MIN	MAX	UNIT	
V _{S-}	Negative supply voltage, referenced to GND	-3	0.3	V	
V _{S+}	Positive supply voltage	-0.3	V _{S-} + 5.5	V	
V _S	Total supply voltage, V _S = V _{S+} - V _{S-}	-0.3	5.5	V	
P _{IN}	Input RF power ⁽²⁾		20	dBm	
V _{PD}	PD pin voltage, referenced to GND	V _{S+} ≥ 3.3V	-0.3	3.6	V
		V _{S+} < 3.3V	-0.3	V _{S+} + 0.3	
V _{OCM}	VOCM pin voltage	V _{S-} + 1	V _{S-} + 4	V	
V _{MODE}	MODE pin voltage	V _{S-} - 0.3	V _{S-} + 3.3	V	
T _J	Junction temperature	-40	150	°C	
T _{stg}	Storage temperature	-40	150	°C	

- (1) Operation outside the *Absolute Maximum Ratings* may cause permanent device damage. *Absolute Maximum Ratings* do not imply functional operation of the device at these or any other conditions beyond those listed under *Recommended Operating Conditions*. If used outside the *Recommended Operating Conditions* but within the *Absolute Maximum Ratings*, the device may not be fully functional, and this may affect device reliability, functionality, performance, and shorten the device lifetime.
- (2) When device supplies are present; otherwise, limit swing at the device pins to V_{S-} ± 0.3V.

6.2 ESD Ratings

			VALUE	UNIT
V _(ESD)	Electrostatic discharge	Human body model (HBM), per ANSI/ESDA/JEDEC JS-001, all pins ⁽¹⁾	±1000	V
		Charged device model (CDM), per ANSI/ESDA/JEDEC JS-002, all pins ⁽²⁾	±500	

- (1) JEDEC document JEP155 states that 500V HBM allows safe manufacturing with a standard ESD control process.
- (2) JEDEC document JEP157 states that 250V CDM allows safe manufacturing with a standard ESD control process.

6.3 Recommended Operating Conditions

over operating free-air temperature range (unless otherwise noted)

		MIN	NOM	MAX	UNIT
V _{S-}	Negative supply voltage	-2.5		0	V
V _S	Total supply voltage, V _S = V _{S+} - V _{S-}	4.75	5	5.25	V
T _J	Junction temperature	-40		125	°C

6.4 Thermal Information

THERMAL METRIC ⁽¹⁾		TRF1305C1		
		RPV (WQFN-FCRLF)		
		12 PINS		
				UNIT
R _{θJA}	Junction-to-ambient thermal resistance	62.6		°C/W
R _{θJC(top)}	Junction-to-case (top) thermal resistance	29.1		°C/W
R _{θJB}	Junction-to-board thermal resistance	26.1		°C/W
Ψ _{JT}	Junction-to-top characterization parameter	0.5		°C/W
Ψ _{JB}	Junction-to-board characterization parameter	26.1		°C/W
R _{θJC(bot)}	Junction-to-case (bottom) thermal resistance	18.8		°C/W

- (1) For information about traditional and new thermal metrics, see the [Semiconductor and IC Package Thermal Metrics](#) application report.

6.5 Electrical Characteristics - AC Specifications in D2D Configuration

at $T_A = 25^\circ\text{C}$, $V_{S+} = 5\text{V}$, $V_{S-} = 0\text{V}$, floating VO_{CM}, PD, and MODE pins, $V_{\text{ICM}} = \text{mid-supply}$, D2D ac-coupled input/output with differential source impedance (Z_S) = 100Ω, differential output load (Z_L) = 100Ω, external input resistor network (see [Figure 8-3](#)), and inputs de-embedded up to $R_{\text{IN_SH}}$ and outputs up to the device pins (unless otherwise noted)

PARAMETER		TEST CONDITIONS		MIN	TYP	MAX	UNIT
AC PERFORMANCE							
SSBW	Small-signal bandwidth (3dB)	$P_{\text{IN}} = -20\text{dBm}$ at each input			7.5		GHz
	Small-signal bandwidth (1dB)	$P_{\text{IN}} = -20\text{dBm}$ at each input			6.5		
LSBW	Large-signal bandwidth (3dB)	Differential $P_{\text{IN}} = 2\text{dBm}$			7.25		GHz
	Large-signal bandwidth (1dB)	Differential $P_{\text{IN}} = 2\text{dBm}$			6.25		
Sdd21	Power gain	$f = 500\text{MHz}$			5.2		dB
		$f = 4\text{GHz}$			5.6		
	Gain variation over temperature	$f = 4\text{GHz}$, $T_A = -40^\circ\text{C}$ to $+85^\circ\text{C}$			1.5		dB
Sdd11	Input return loss	$f = 10\text{MHz}$ to 5GHz			-14		dB
Sdd12	Reverse isolation	$f < 5\text{GHz}$ (device enabled)			-22		dB
OP1dB	Output 1dB compression point	$f = 500\text{MHz}$			15.1		dBm
		$f = 1\text{GHz}$			15.3		
		$f = 2\text{GHz}$			15.2		
		$f = 3\text{GHz}$			14		
		$f = 4\text{GHz}$			12.6		
		$f = 5\text{GHz}$			11		
HD2	Second-order harmonic distortion	$V_O = 2V_{\text{PP}}$	$f = 500\text{MHz}$		-81		dBc
			$f = 1\text{GHz}$		-70		
			$f = 2\text{GHz}$		-62		
			$f = 3\text{GHz}$		-55		
			$f = 4\text{GHz}$		-51		
HD3	Third-order harmonic distortion	$V_O = 2V_{\text{PP}}$	$f = 500\text{MHz}$		-72		dBc
			$f = 1\text{GHz}$		-66		
			$f = 2\text{GHz}$		-52		
			$f = 3\text{GHz}$		-48		
			$f = 4\text{GHz}$		-45		
OIP2	Output second-order intercept point	$P_O = 1\text{dBm}$ per tone, 2MHz spacing	$f = 500\text{MHz}$		80		dBm
			$f = 1\text{GHz}$		71		
			$f = 2\text{GHz}$		63		
			$f = 3\text{GHz}$		57		
			$f = 4\text{GHz}$		54		
			$f = 5\text{GHz}$		55		
OIP3	Output third-order intercept point	$P_O = 1\text{dBm}$ per tone, 2MHz spacing	$f = 500\text{MHz}$		43.5		dBm
			$f = 1\text{GHz}$		38.5		
			$f = 2\text{GHz}$		33.5		
			$f = 3\text{GHz}$		29		
			$f = 4\text{GHz}$		25		
			$f = 5\text{GHz}$		18		

6.5 Electrical Characteristics - AC Specifications in D2D Configuration (continued)

at $T_A = 25^\circ\text{C}$, $V_{S+} = 5\text{V}$, $V_{S-} = 0\text{V}$, floating VO_{CM}, PD, and MODE pins, V_{ICM} = mid-supply, D2D ac-coupled input/output with differential source impedance (Z_S) = 100 Ω , differential output load (Z_L) = 100 Ω , external input resistor network (see [Figure 8-3](#)), and inputs de-embedded up to R_{IN_SH} and outputs up to the device pins (unless otherwise noted)

PARAMETER		TEST CONDITIONS	MIN	TYP	MAX	UNIT
NF	Noise figure	f = 500MHz		11.3		dB
		f = 1GHz		11.7		
		f = 2GHz		13.7		
		f = 3GHz		15.2		
		f = 4GHz		17.1		
		f = 5GHz		17.1		
NSD	Output noise spectral density	f = 500MHz		-157.5		dBm/Hz
		f = 1GHz		-157		
		f = 2GHz		-154.6		
		f = 3GHz		-152.9		
		f = 4GHz		-151		
		f = 5GHz		-151.3		

6.6 Electrical Characteristics - AC Specifications in S2D Configuration

at $T_A = 25^\circ\text{C}$, $V_{S+} = 5\text{V}$, $V_{S-} = 0\text{V}$, floating VO_{CM}, PD, and MODE pins, V_{ICM} = mid-supply, S2D ac-coupled input/output configuration with $R_{\text{TERM}} = 50\Omega$, $Z_S = 50\Omega$, $Z_L = 100\Omega$ (see Figure 8-1), and input and outputs de-embedded up to the device pins (unless otherwise noted)

PARAMETER		TEST CONDITIONS		MIN	TYP	MAX	UNIT
AC PERFORMANCE							
SSBW	Small-signal bandwidth (3dB)	$P_{\text{IN}} = -20\text{dBm}$ at each input			8.3		GHz
	Small-signal bandwidth (1dB)	$P_{\text{IN}} = -20\text{dBm}$ at each input			7.5		
LSBW	Large-signal bandwidth (3dB)	Single-ended $P_{\text{IN}} = 2\text{dBm}$			7.8		GHz
	Large-signal bandwidth (1dB)	Single-ended $P_{\text{IN}} = 2\text{dBm}$			7.2		
Sds21	Power gain	$f = 500\text{MHz}$			5.2		dB
		$f = 4\text{GHz}$			5.2		
	Gain variation over temperature	$f = 4\text{GHz}$, $T_A = -40^\circ\text{C}$ to $+85^\circ\text{C}$			1.5		dB
Sss11	Input return loss	$f = 10\text{MHz}$ to 5GHz			-11		dB
Ssd12	Reverse isolation	$f < 5\text{GHz}$ (device enabled)			-22		dB
G_{IMB}	Differential output gain imbalance	$f < 5\text{GHz}$, $P_{\text{IN}} = -20\text{dBm}$ with $50\Omega Z_S$			± 0.4		dB
PH_{IMB}	Differential output phase imbalance	$f < 5\text{GHz}$, $P_{\text{IN}} = -20\text{dBm}$ with $50\Omega Z_S$			± 5.5		$^\circ$
OP1dB	Output 1dB compression point	$f = 500\text{MHz}$			14.3		dBm
		$f = 1\text{GHz}$			14.6		
		$f = 2\text{GHz}$			14.3		
		$f = 3\text{GHz}$			13		
		$f = 4\text{GHz}$			11.3		
		$f = 5\text{GHz}$			10.3		
HD2	Second-order harmonic distortion	$V_O = 2V_{\text{PP}}$	$f = 500\text{MHz}$		-68		dBc
			$f = 1\text{GHz}$		-55		
			$f = 2\text{GHz}$		-42		
			$f = 3\text{GHz}$		-36		
			$f = 4\text{GHz}$		-32		
HD3	Third-order harmonic distortion	$V_O = 2V_{\text{PP}}$	$f = 500\text{MHz}$		-72		dBc
			$f = 1\text{GHz}$		-70		
			$f = 2\text{GHz}$		-51		
			$f = 3\text{GHz}$		-50		
			$f = 4\text{GHz}$		-54		
OIP2	Output second-order intercept point	$P_O = 1\text{dBm}$ per tone, 2MHz spacing	$f = 500\text{MHz}$		71		dBm
			$f = 1\text{GHz}$		59		
			$f = 2\text{GHz}$		47		
			$f = 3\text{GHz}$		38		
			$f = 4\text{GHz}$		34		
			$f = 5\text{GHz}$		35		
OIP3	Output third-order intercept point	$P_O = 1\text{dBm}$ per tone, 2MHz spacing	$f = 500\text{MHz}$		41.5		dBm
			$f = 1\text{GHz}$		37		
			$f = 2\text{GHz}$		32		
			$f = 3\text{GHz}$		28		
			$f = 4\text{GHz}$		22		
			$f = 5\text{GHz}$		19		

6.6 Electrical Characteristics - AC Specifications in S2D Configuration (continued)

at $T_A = 25^\circ\text{C}$, $V_{S+} = 5\text{V}$, $V_{S-} = 0\text{V}$, floating VO_{CM}, PD, and MODE pins, $V_{\text{ICM}} = \text{mid-supply}$, S2D ac-coupled input/output configuration with $R_{\text{TERM}} = 50\Omega$, $Z_S = 50\Omega$, $Z_L = 100\Omega$ (see [Figure 8-1](#)), and input and outputs de-embedded up to the device pins (unless otherwise noted)

PARAMETER		TEST CONDITIONS	MIN	TYP	MAX	UNIT
NF	Noise figure	f = 500MHz		12		dB
		f = 1GHz		12.8		
		f = 2GHz		13.4		
		f = 3GHz		14.8		
		f = 4GHz		16.4		
		f = 5GHz		17		
NSD	Output noise spectral density	f = 500MHz		-156.8		dBm/Hz
		f = 1GHz		-156		
		f = 2GHz		-155.4		
		f = 3GHz		-154		
		f = 4GHz		-152.4		
		f = 5GHz		-151.6		

6.7 Electrical Characteristics - DC and Timing Specifications

at $T_A = 25^\circ\text{C}$, $V_{S+} = 5\text{V}$, $V_{S-} = 0\text{V}$, floating VO_{CM}, PD, and MODE pins, $V_{\text{ICM}} = \text{mid-supply}$, $Z_L = 100\Omega$, and specifications apply to both S2D and D2D configuration (unless otherwise noted)

PARAMETER		TEST CONDITIONS	MIN	TYP	MAX	UNIT
DC PERFORMANCE						
$V_{\text{OD-MAX}}$	Max differential output voltage	$f = 1\text{GHz}$		4		V_{PP}
	Slew rate	2V V_{O} step, dc coupled, $V_{S+} = 2.5\text{V}$, $V_{S-} = -2.5\text{V}$		25		kV/ μs
	Output differential offset voltage			± 3		mV
	Overdrive recovery time	DC coupled, $V_{S+} = 2.5\text{V}$, $V_{S-} = -2.5\text{V}$, from 2 × overdrive of each SE output to each output voltage settling to $< \pm 50\text{mV}$		6		ns
COMMON-MODE						
V_{ICM}	Input common-mode voltage	Default range ⁽¹⁾	$V_{S-} + 1.5$	$V_{S-} + 3.5$		V
V_{OCM}	Output common-mode voltage		$V_{S-} + 2$	$V_{S-} + 3$		V
	Output common-mode offset voltage from V_{OCM} voltage		-20		20	mV
IMPEDANCE						
$Z_{\text{IN-SE}}$	Single-ended input impedance	S2D, at INP pin with 50 Ω termination on INM pin		45		Ω
$Z_{\text{IN-DIFF}}$	Differential input impedance	D2D, looking into the device pins		33.3		Ω
		D2D, looking into $R_{\text{IN-SH}}$, see Figure 8-3		76.9		
$Z_{\text{O-DIFF}}$	Differential output impedance	Differential output impedance		8		Ω
POWER SUPPLY						
I_{QA}	Active quiescent current			108		mA
I_{QPD}	Power-down quiescent current			14		mA
POWER DOWN						
$V_{\text{PD_HI}}$	PD pin logic high	Referenced to GND, see Section 6.1	1.35			V
$V_{\text{PD_LO}}$	PD pin logic low	Referenced to GND, see Section 6.1			0.3	V
$I_{\text{PD_Bias}}$	PD bias current (current on PD pin)	PD = high (1.8V logic)		10.5	15	μA
		PD = high (3.3V logic)		19	30	
t_{ON}	Turn-on time	S2D, dc coupled, $V_{S+} = 2.5\text{V}$, $V_{S-} = -2.5\text{V}$, from 50% V_{PD} transition to 90% RF out		25		ns
t_{OFF}	Turn-off time	S2D, dc coupled, $V_{S+} = 2.5\text{V}$, $V_{S-} = -2.5\text{V}$, from 50% V_{PD} transition to 10% RF out		20		ns

(1) V_{ICM} range can be extended closer to V_{S+} or V_{S-} in D2D configuration. See also [Section 7.4.1](#).

6.8 Typical Characteristics: D2D Configuration

at $T_A = 25^\circ\text{C}$, $V_{S+} = 5\text{V}$, $V_{S-} = 0\text{V}$, floating VO_{CM}, PD, and MODE pins, $V_{\text{ICM}} = \text{mid-supply}$, D2D ac-coupled input/output configuration with $Z_S = 100\Omega$, $Z_L = 100\Omega$, external input resistor network (see Figure 8-3), inputs de-embedded up to $R_{\text{IN_SH}}$ and outputs up to the device pins, ambient temperatures shown, and resistor network included as part of DUT characteristic plots (unless otherwise noted)

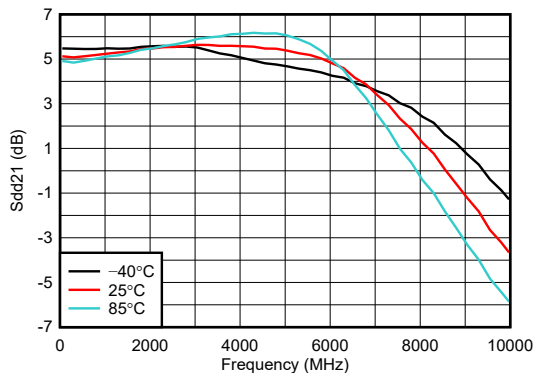

$P_{\text{IN}} = -20\text{dBm}$ with 50Ω source at all excited ports, nonexcited ports are terminated with 50Ω

Figure 6-1. Power Gain (Sdd21) Across Temperature

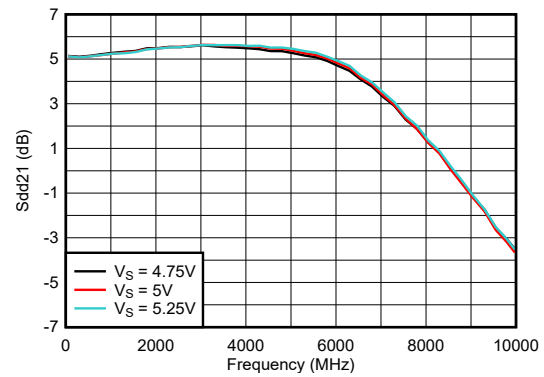

$P_{\text{IN}} = -20\text{dBm}$ with 50Ω source at all excited ports, nonexcited ports are terminated with 50Ω

Figure 6-2. Power Gain (Sdd21) Across Supply Voltage

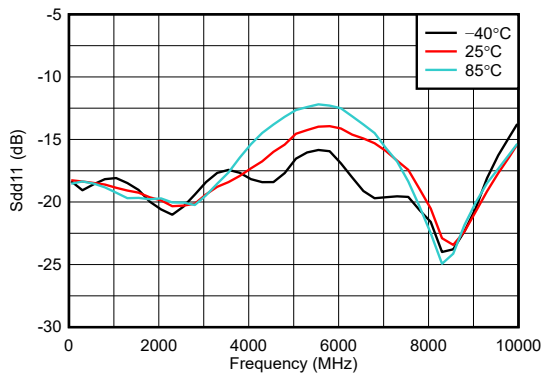

$P_{\text{IN}} = -20\text{dBm}$ with 50Ω source at all excited ports, nonexcited ports are terminated with 50Ω

Figure 6-3. Input Return Loss (Sdd11) Across Temperature

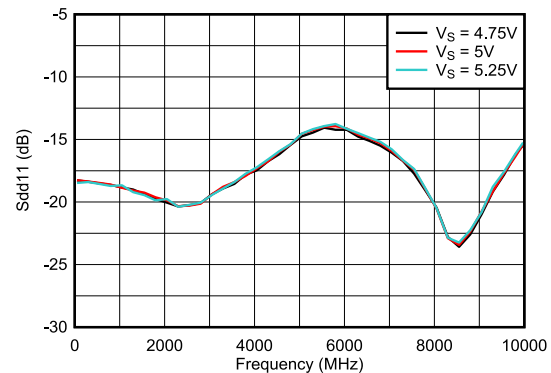

$P_{\text{IN}} = -20\text{dBm}$ with 50Ω source at all excited ports, nonexcited ports are terminated with 50Ω

Figure 6-4. Input Return Loss (Sdd11) Across Supply Voltage

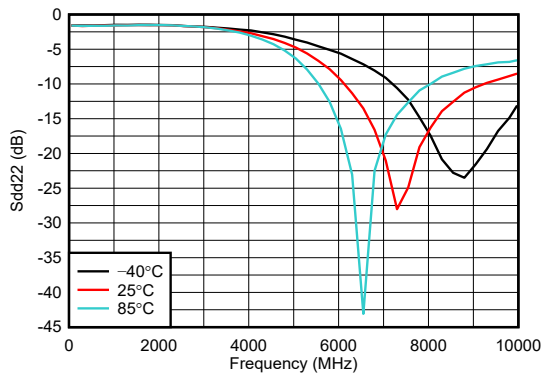

$P_{\text{IN}} = -20\text{dBm}$ with 50Ω source at all excited ports, nonexcited ports are terminated with 50Ω

Figure 6-5. Output Return Loss (Sdd22) Across Temperature

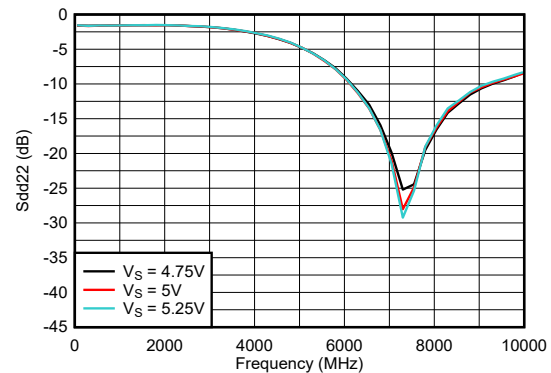

$P_{\text{IN}} = -20\text{dBm}$ with 50Ω source at all excited ports, nonexcited ports are terminated with 50Ω

Figure 6-6. Output Return Loss (Sdd22) Across Supply Voltage

6.8 Typical Characteristics: D2D Configuration (continued)

at $T_A = 25^\circ\text{C}$, $V_{S+} = 5\text{V}$, $V_{S-} = 0\text{V}$, floating VO_{CM}, PD, and MODE pins, $V_{\text{ICM}} = \text{mid-supply}$, D2D ac-coupled input/output configuration with $Z_S = 100\Omega$, $Z_L = 100\Omega$, external input resistor network (see Figure 8-3), inputs de-embedded up to $R_{\text{IN_SH}}$ and outputs up to the device pins, ambient temperatures shown, and resistor network included as part of DUT characteristic plots (unless otherwise noted)

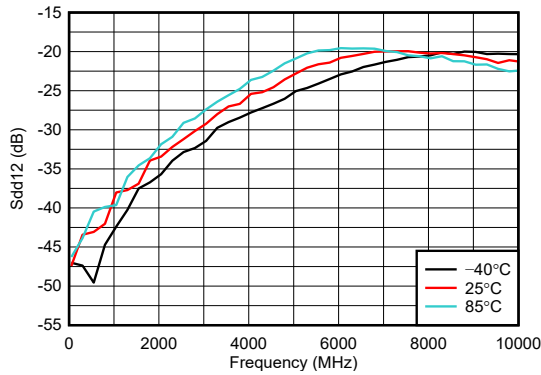

$P_{\text{IN}} = -20\text{dBm}$ with 50Ω source at all excited ports, nonexcited ports are terminated with 50Ω

Figure 6-7. Reverse Isolation (Sdd12) Across Temperature

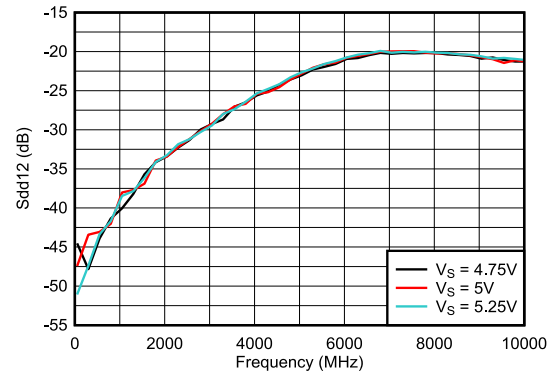

$P_{\text{IN}} = -20\text{dBm}$ with 50Ω source at all excited ports, nonexcited ports are terminated with 50Ω

Figure 6-8. Reverse Isolation (Sdd12) Across Supply Voltage

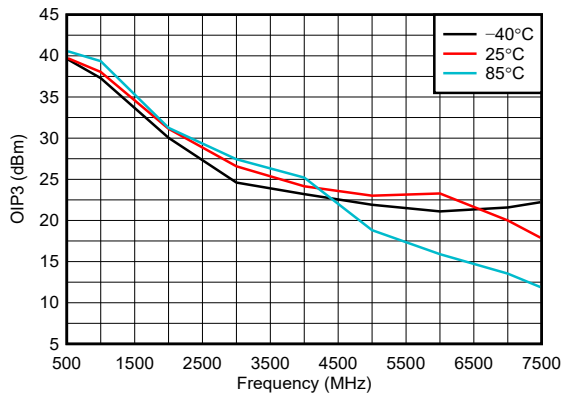

$P_O = -5\text{dBm/tone}$, 2MHz tone spacing

Figure 6-9. OIP3 Across Temperature

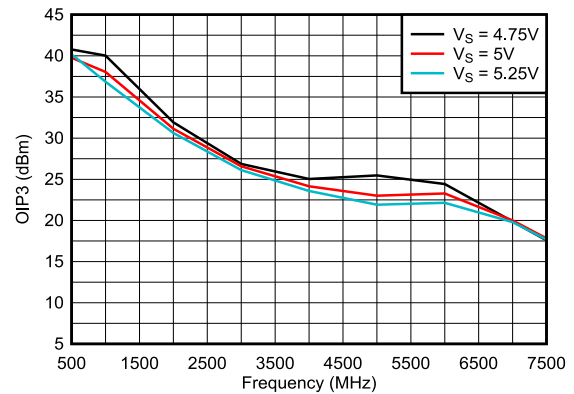

$P_O = -5\text{dBm/tone}$, 2MHz tone spacing

Figure 6-10. OIP3 Across Supply Voltage

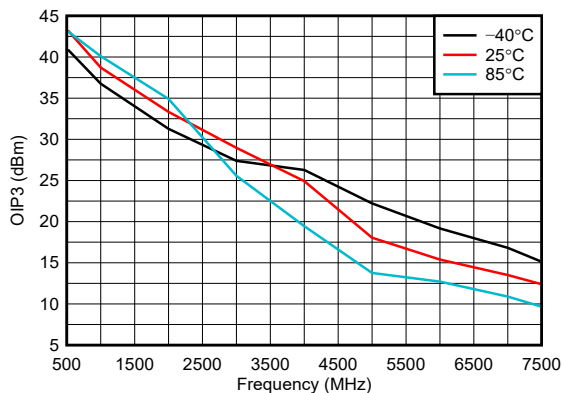

$P_O = 1\text{dBm/tone}$, 2MHz tone spacing

Figure 6-11. OIP3 Across Temperature

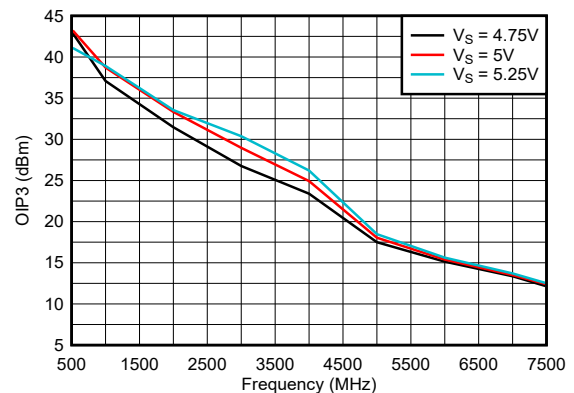

$P_O = 1\text{dBm/tone}$, 2MHz tone spacing

Figure 6-12. OIP3 Across Supply Voltage

6.8 Typical Characteristics: D2D Configuration (continued)

at $T_A = 25^\circ\text{C}$, $V_{S+} = 5\text{V}$, $V_{S-} = 0\text{V}$, floating VO_{CM}, PD, and MODE pins, $V_{\text{ICM}} = \text{mid-supply}$, D2D ac-coupled input/output configuration with $Z_S = 100\Omega$, $Z_L = 100\Omega$, external input resistor network (see Figure 8-3), inputs de-embedded up to $R_{\text{IN_SH}}$ and outputs up to the device pins, ambient temperatures shown, and resistor network included as part of DUT characteristic plots (unless otherwise noted)

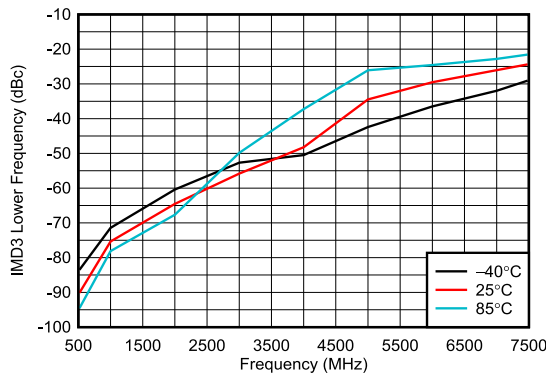

At $(2f_1 - f_2)$ frequency where $f_1 < f_2$,
 $P_O = 1\text{dBm/tone}$, 2MHz tone spacing

Figure 6-13. IMD3 Lower Across Temperature

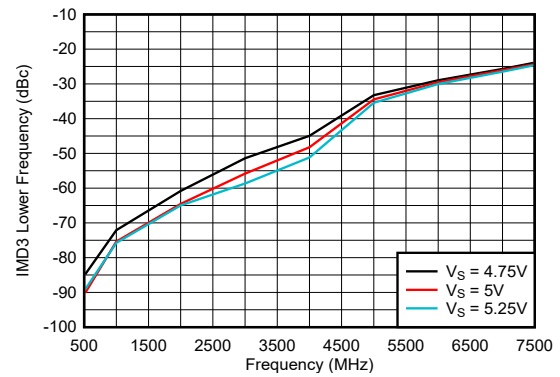

At $(2f_1 - f_2)$ frequency where $f_1 < f_2$,
 $P_O = 1\text{dBm/tone}$, 2MHz tone spacing

Figure 6-14. IMD3 Lower Across Supply Voltage

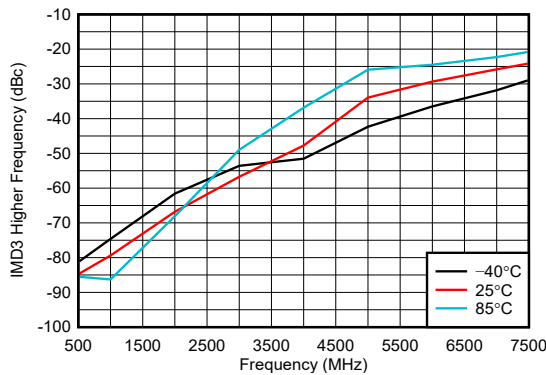

At $(2f_2 - f_1)$ frequency where $f_1 < f_2$,
 $P_O = 1\text{dBm/tone}$, 2MHz tone spacing

Figure 6-15. IMD3 Higher Across Temperature

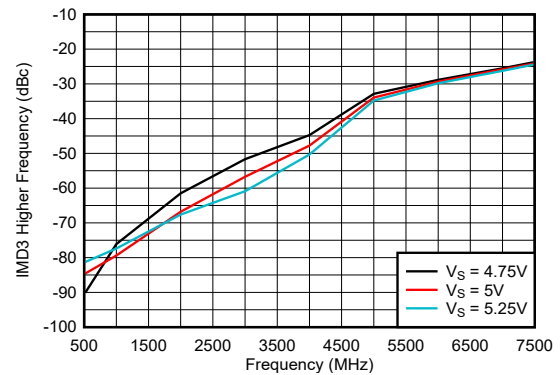

At $(2f_2 - f_1)$ frequency where $f_1 < f_2$,
 $P_O = 1\text{dBm/tone}$, 2MHz tone spacing

Figure 6-16. IMD3 Higher Across Supply Voltage

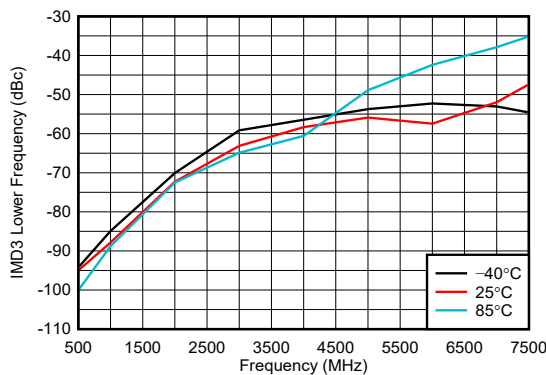

At $(2f_1 - f_2)$ frequency where $f_1 < f_2$,
 $P_O = -5\text{dBm/tone}$, 2MHz tone spacing

Figure 6-17. IMD3 Lower Across Temperature

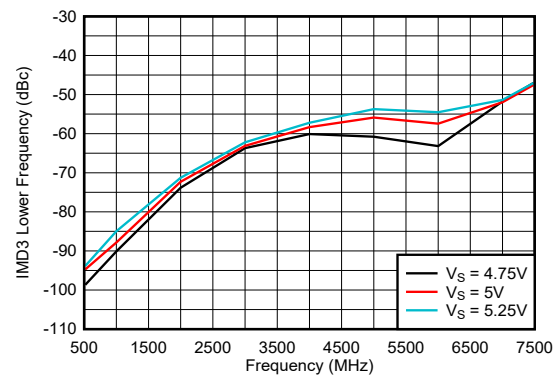

At $(2f_1 - f_2)$ frequency where $f_1 < f_2$,
 $P_O = -5\text{dBm/tone}$, 2MHz tone spacing

Figure 6-18. IMD3 Lower Across Supply Voltage

6.8 Typical Characteristics: D2D Configuration (continued)

at $T_A = 25^\circ\text{C}$, $V_{S+} = 5\text{V}$, $V_{S-} = 0\text{V}$, floating VO_{CM}, PD, and MODE pins, $V_{\text{ICM}} = \text{mid-supply}$, D2D ac-coupled input/output configuration with $Z_S = 100\Omega$, $Z_L = 100\Omega$, external input resistor network (see Figure 8-3), inputs de-embedded up to $R_{\text{IN_SH}}$ and outputs up to the device pins, ambient temperatures shown, and resistor network included as part of DUT characteristic plots (unless otherwise noted)

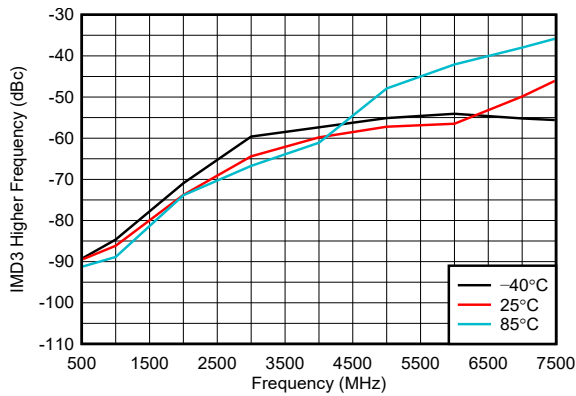

At $(2f_2 - f_1)$ frequency where $f_1 < f_2$,
 $P_O = -5\text{dBm/tone}$, 2MHz tone spacing

Figure 6-19. IMD3 Higher Across Temperature

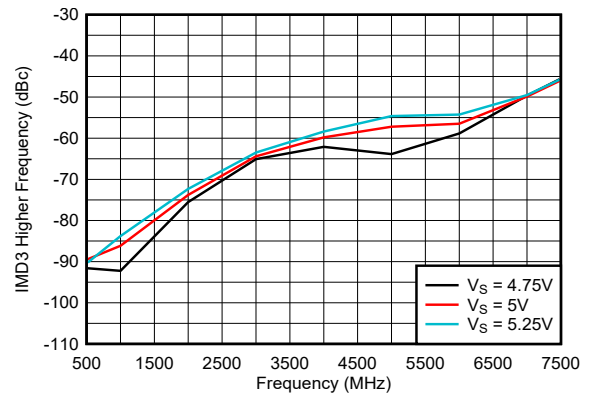

At $(2f_2 - f_1)$ frequency where $f_1 < f_2$,
 $P_O = -5\text{dBm/tone}$, 2MHz tone spacing

Figure 6-20. IMD3 Higher Across Supply Voltage

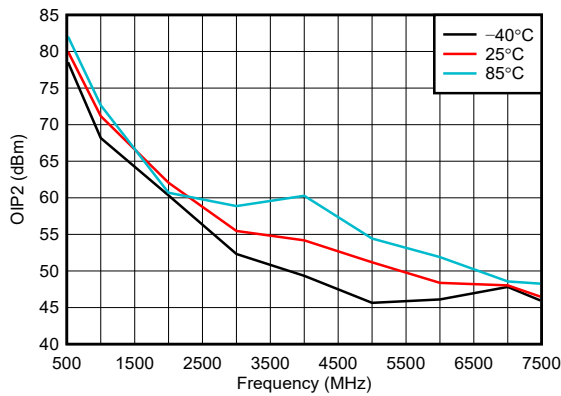

$P_O = -5\text{dBm/tone}$, 2MHz tone spacing

Figure 6-21. OIP2 Across Temperature

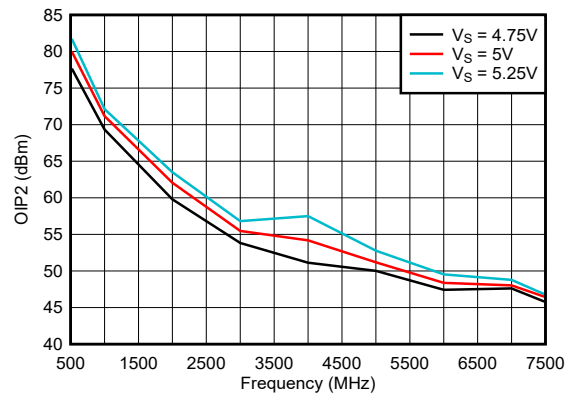

$P_O = -5\text{dBm/tone}$, 2MHz tone spacing

Figure 6-22. OIP2 Across Supply Voltage

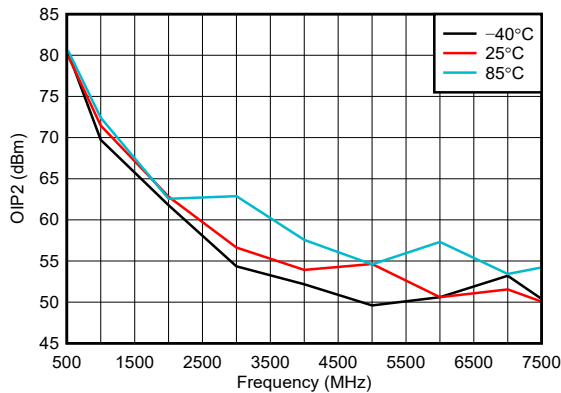

$P_O = 1\text{dBm/tone}$, 2MHz tone spacing

Figure 6-23. OIP2 Across Temperature

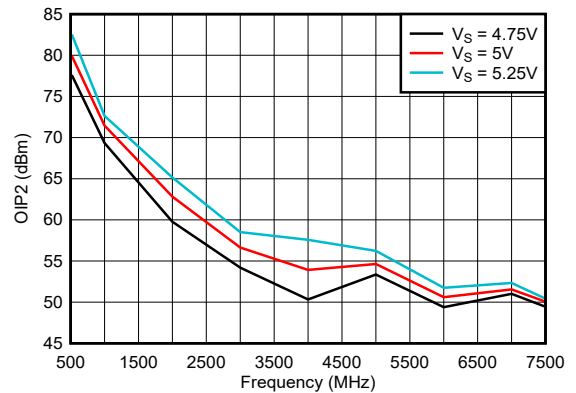

$P_O = 1\text{dBm/tone}$, 2MHz tone spacing

Figure 6-24. OIP2 Across Supply Voltage

6.8 Typical Characteristics: D2D Configuration (continued)

at $T_A = 25^\circ\text{C}$, $V_{S+} = 5\text{V}$, $V_{S-} = 0\text{V}$, floating VO_{CM}, PD, and MODE pins, $V_{\text{ICM}} = \text{mid-supply}$, D2D ac-coupled input/output configuration with $Z_S = 100\Omega$, $Z_L = 100\Omega$, external input resistor network (see Figure 8-3), inputs de-embedded up to $R_{\text{IN_SH}}$ and outputs up to the device pins, ambient temperatures shown, and resistor network included as part of DUT characteristic plots (unless otherwise noted)

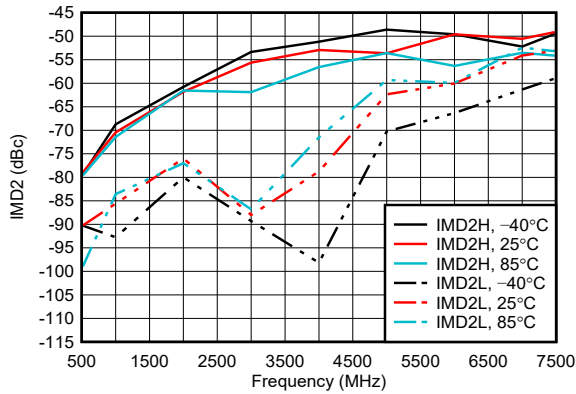

$P_O = 1\text{dBm/tone}$, 2MHz tone spacing
Figure 6-25. IMD2 Across Temperature

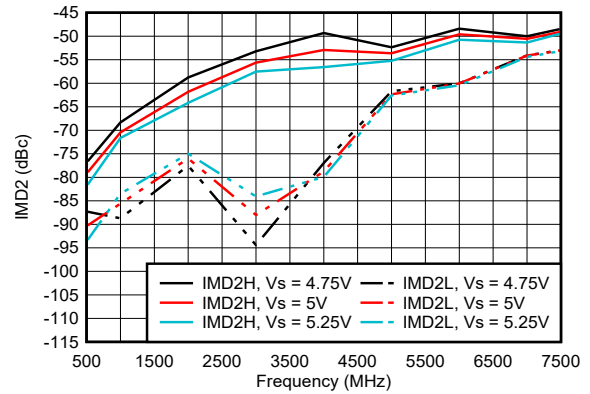

$P_O = 1\text{dBm/tone}$, 2MHz tone spacing
Figure 6-26. IMD2 Across Supply Voltage

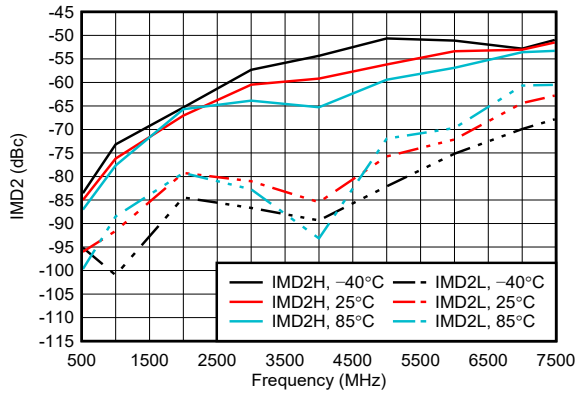

$P_O = -5\text{dBm/tone}$, 2MHz tone spacing
Figure 6-27. IMD2 Across Temperature

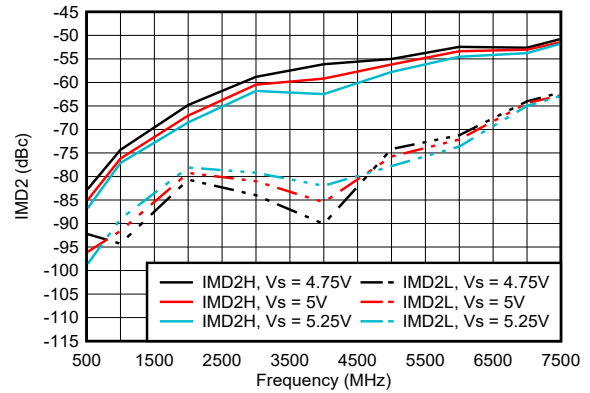

$P_O = -5\text{dBm/tone}$, 2MHz tone spacing
Figure 6-28. IMD2 Across Supply Voltage

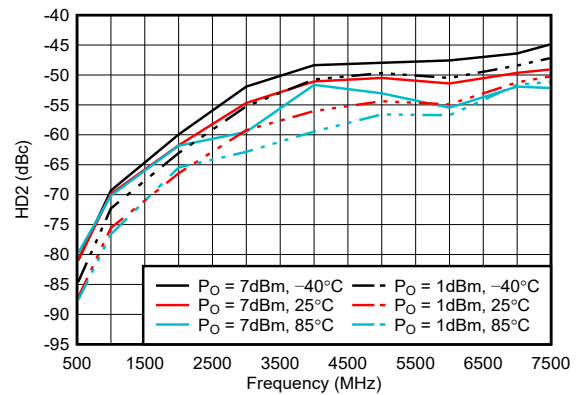

Figure 6-29. HD2 Across Output Power and Temperature

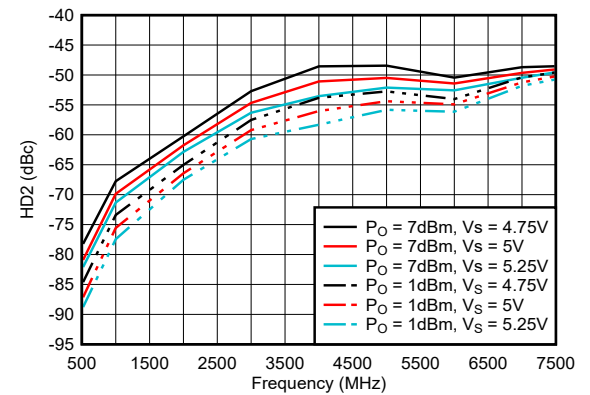

Figure 6-30. HD2 Across Output Power and Supply Voltage

6.8 Typical Characteristics: D2D Configuration (continued)

at $T_A = 25^\circ\text{C}$, $V_{S+} = 5\text{V}$, $V_{S-} = 0\text{V}$, floating VO_{CM}, PD, and MODE pins, $V_{\text{ICM}} = \text{mid-supply}$, D2D ac-coupled input/output configuration with $Z_S = 100\Omega$, $Z_L = 100\Omega$, external input resistor network (see Figure 8-3), inputs de-embedded up to $R_{\text{IN_SH}}$ and outputs up to the device pins, ambient temperatures shown, and resistor network included as part of DUT characteristic plots (unless otherwise noted)

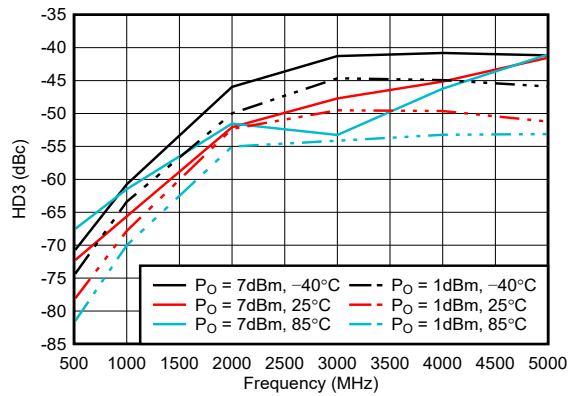

Figure 6-31. HD3 Across Output Power and Temperature

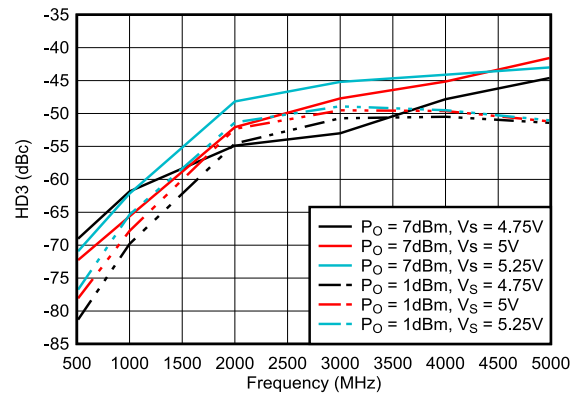

Figure 6-32. HD3 Across Output Power and Supply Voltage

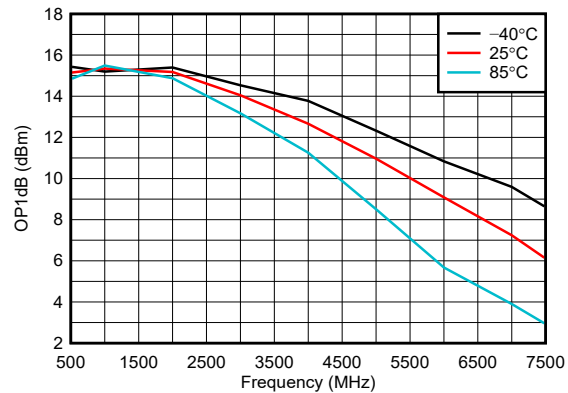

Figure 6-33. OP1dB Across Temperature

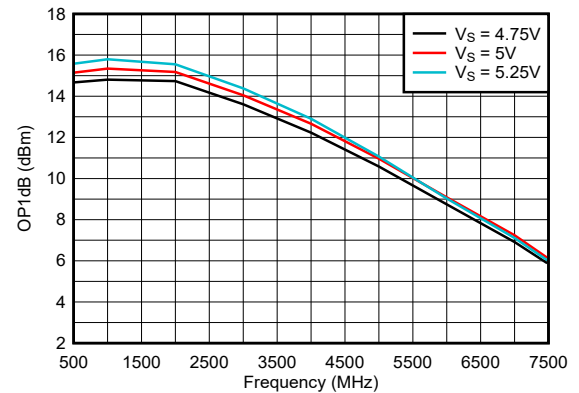

Figure 6-34. OP1dB Across Supply Voltage

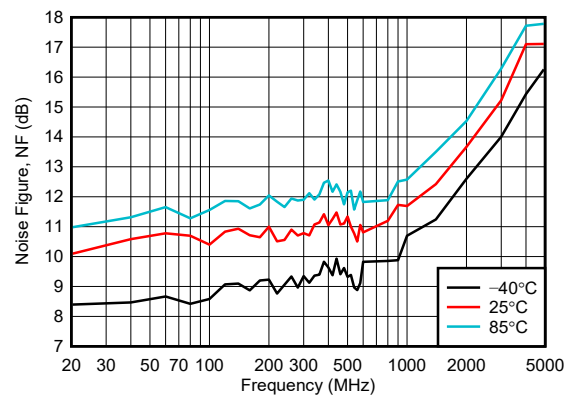

Figure 6-35. Noise Figure Across Temperature

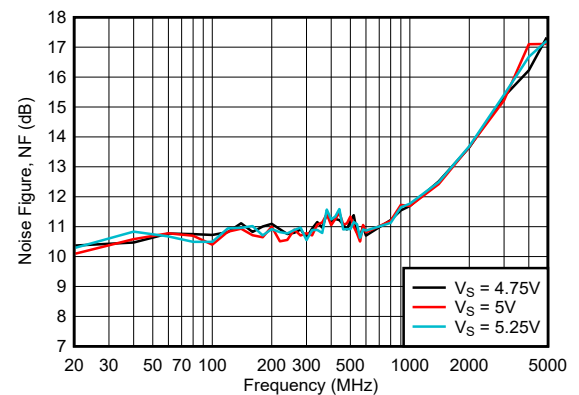

Figure 6-36. Noise Figure Across Supply Voltage

6.8 Typical Characteristics: D2D Configuration (continued)

at $T_A = 25^\circ\text{C}$, $V_{S+} = 5\text{V}$, $V_{S-} = 0\text{V}$, floating VO_{CM}, PD, and MODE pins, $V_{ICM} = \text{mid-supply}$, D2D ac-coupled input/output configuration with $Z_S = 100\Omega$, $Z_L = 100\Omega$, external input resistor network (see Figure 8-3), inputs de-embedded up to R_{IN_SH} and outputs up to the device pins, ambient temperatures shown, and resistor network included as part of DUT characteristic plots (unless otherwise noted)

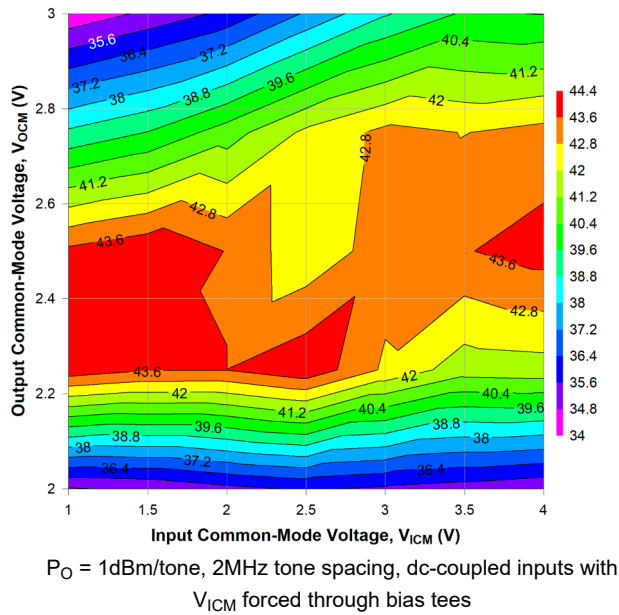

Figure 6-37. OIP3 Across V_{ICM} and V_{OCM} at 500MHz

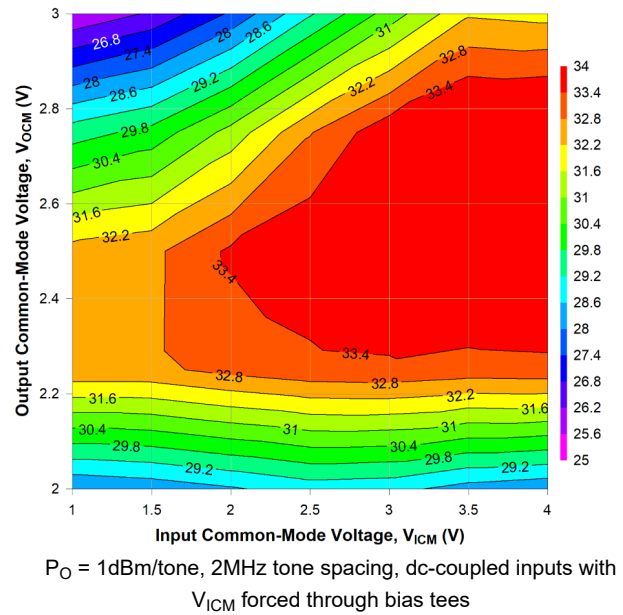

Figure 6-38. OIP3 Across V_{ICM} and V_{OCM} at 2GHz

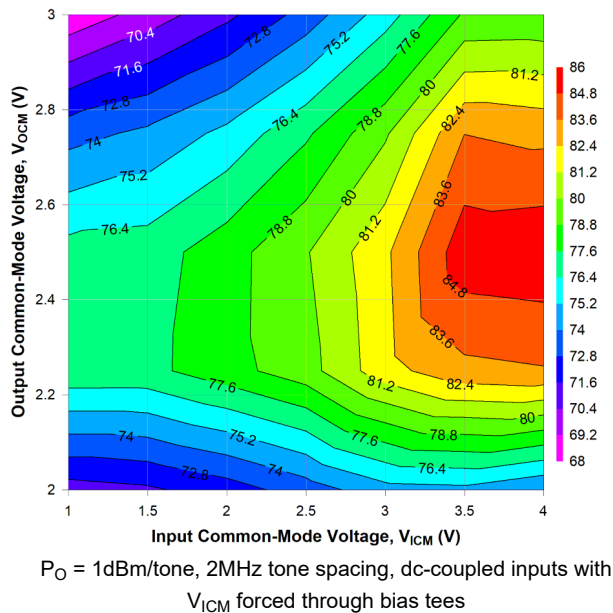

Figure 6-39. OIP2 Across V_{ICM} and V_{OCM} at 500MHz

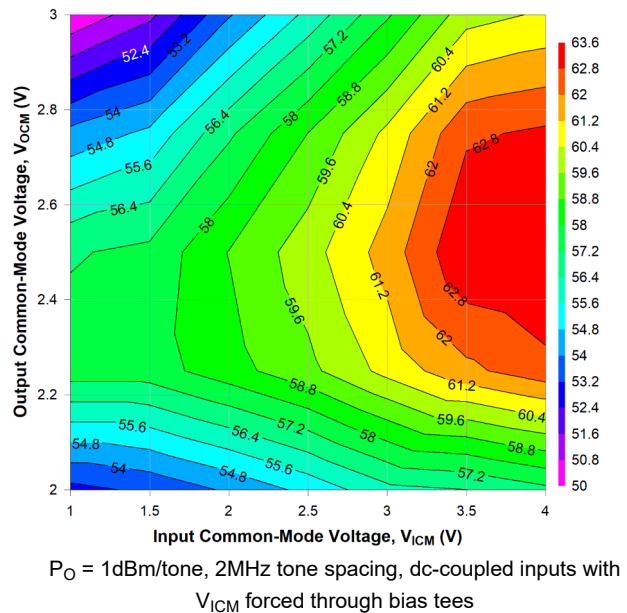

Figure 6-40. OIP2 Across V_{ICM} and V_{OCM} at 2GHz

6.8 Typical Characteristics: D2D Configuration (continued)

at $T_A = 25^\circ\text{C}$, $V_{S+} = 5\text{V}$, $V_{S-} = 0\text{V}$, floating VO_{CM}, PD, and MODE pins, $V_{\text{ICM}} = \text{mid-supply}$, D2D ac-coupled input/output configuration with $Z_S = 100\Omega$, $Z_L = 100\Omega$, external input resistor network (see Figure 8-3), inputs de-embedded up to $R_{\text{IN_SH}}$ and outputs up to the device pins, ambient temperatures shown, and resistor network included as part of DUT characteristic plots (unless otherwise noted)

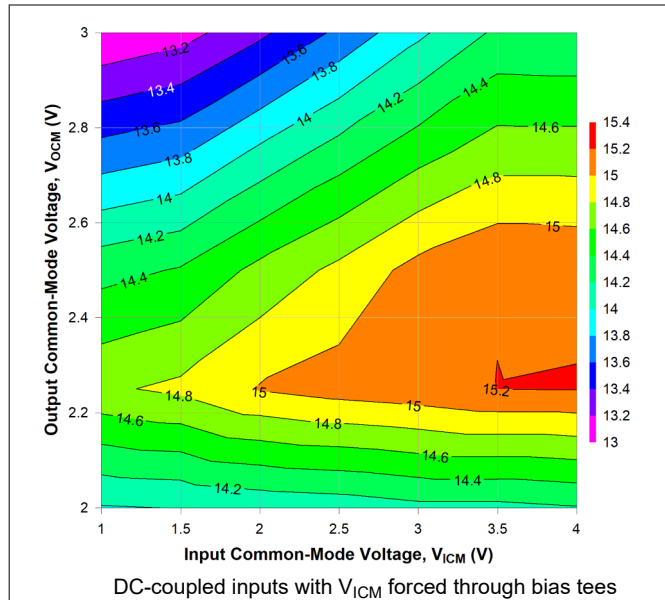

Figure 6-41. OP1dB Across V_{ICM} and V_{OCM} at 500MHz

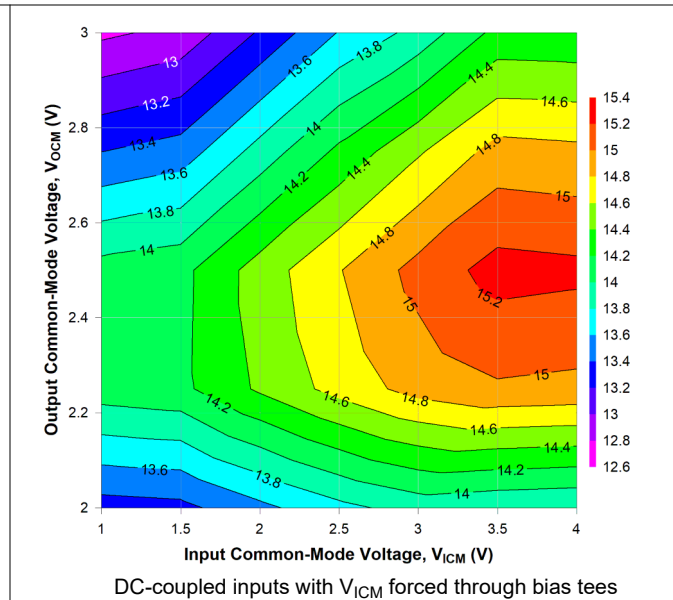

Figure 6-42. OP1dB Across V_{ICM} and V_{OCM} at 2GHz

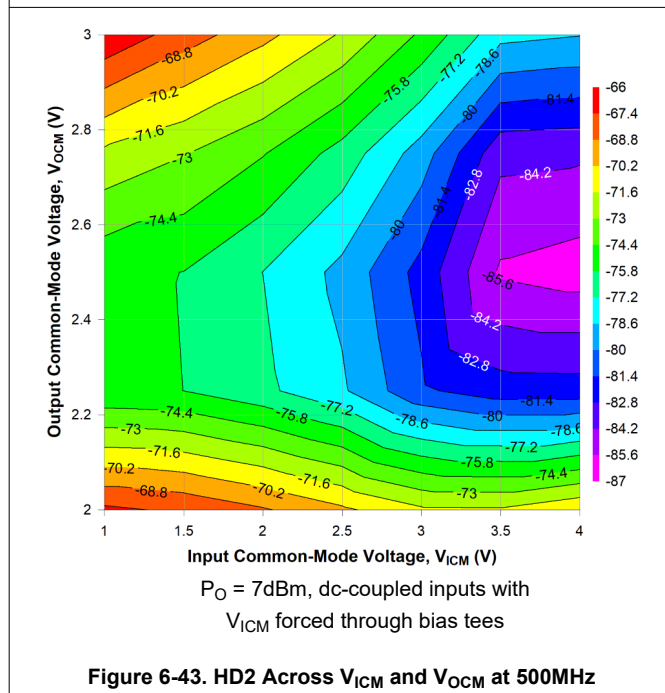

Figure 6-43. HD2 Across V_{ICM} and V_{OCM} at 500MHz

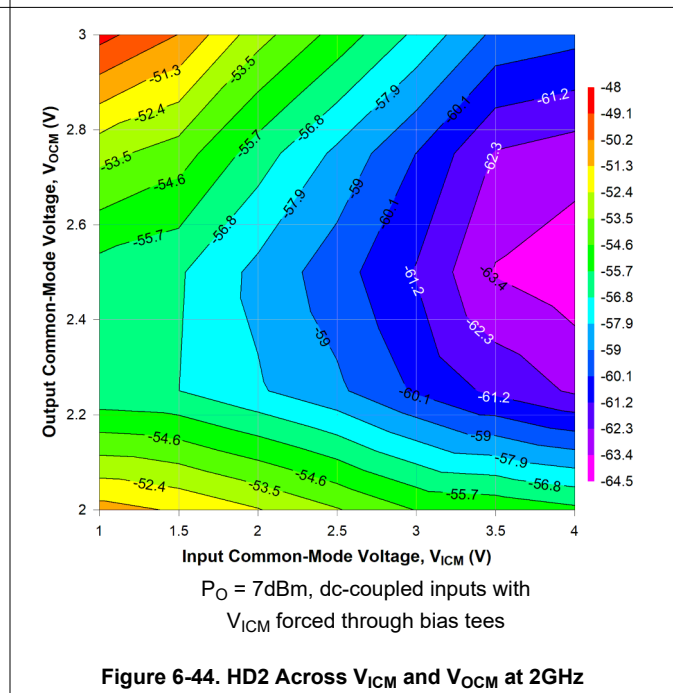
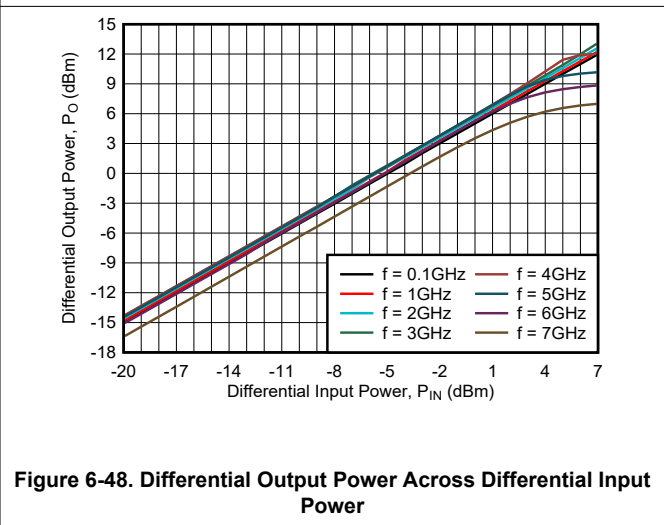
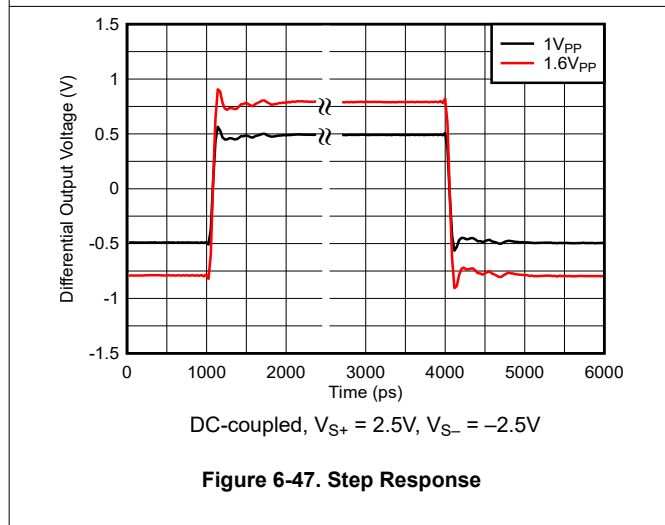
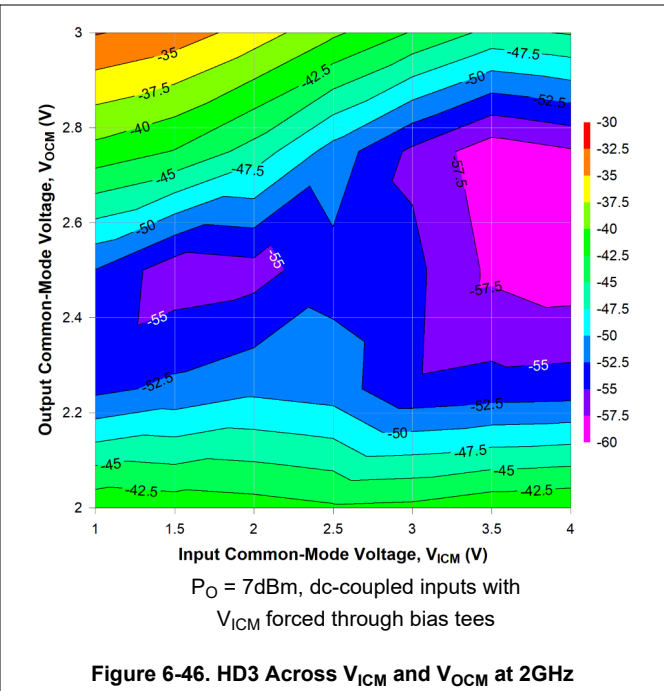
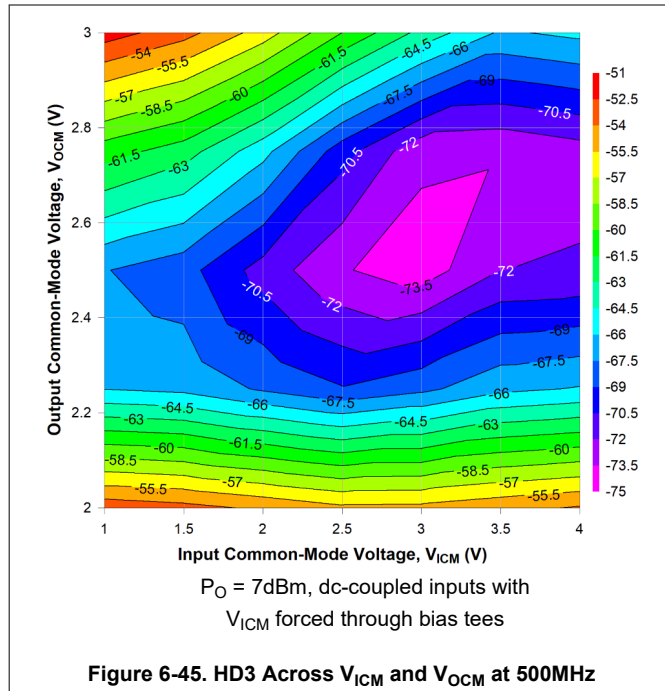

Figure 6-44. HD2 Across V_{ICM} and V_{OCM} at 2GHz

6.8 Typical Characteristics: D2D Configuration (continued)

at $T_A = 25^\circ\text{C}$, $V_{S+} = 5\text{V}$, $V_{S-} = 0\text{V}$, floating VO_{CM}, PD, and MODE pins, $V_{\text{ICM}} = \text{mid-supply}$, D2D ac-coupled input/output configuration with $Z_S = 100\Omega$, $Z_L = 100\Omega$, external input resistor network (see Figure 8-3), inputs de-embedded up to $R_{\text{IN_SH}}$ and outputs up to the device pins, ambient temperatures shown, and resistor network included as part of DUT characteristic plots (unless otherwise noted)



6.8 Typical Characteristics: D2D Configuration (continued)

at $T_A = 25^\circ\text{C}$, $V_{S+} = 5\text{V}$, $V_{S-} = 0\text{V}$, floating VO_{CM}, PD, and MODE pins, $V_{\text{ICM}} = \text{mid-supply}$, D2D ac-coupled input/output configuration with $Z_S = 100\Omega$, $Z_L = 100\Omega$, external input resistor network (see Figure 8-3), inputs de-embedded up to $R_{\text{IN_SH}}$ and outputs up to the device pins, ambient temperatures shown, and resistor network included as part of DUT characteristic plots (unless otherwise noted)

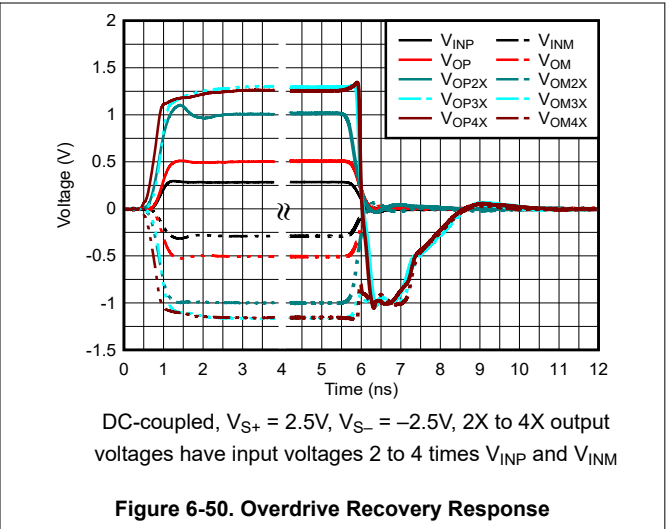
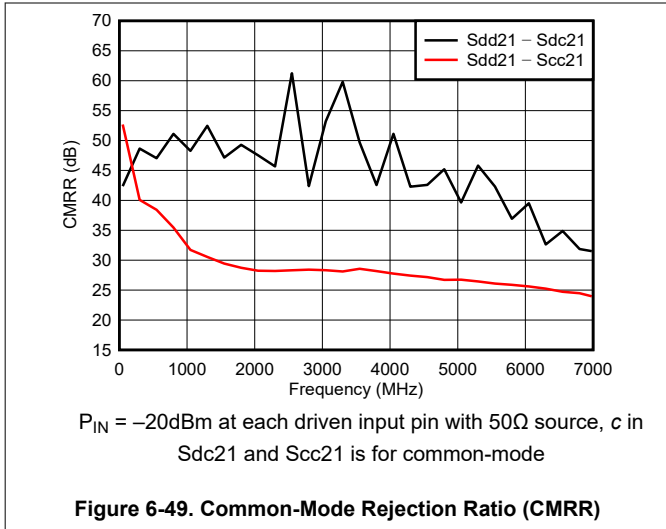

6.9 Typical Characteristics: S2D Configuration

at $T_A = 25^\circ\text{C}$, $V_{S+} = 5\text{V}$, $V_{S-} = 0\text{V}$, floating VO_{CM}, PD, and MODE pins, $V_{\text{ICM}} = \text{mid-supply}$, S2D ac-coupled input/output configuration with $R_{\text{TERM}} = 50\Omega$, $Z_S = 50\Omega$, $Z_L = 100\Omega$ (see Figure 8-1), input and outputs de-embedded up to the device pins, and ambient temperatures shown (unless otherwise noted)

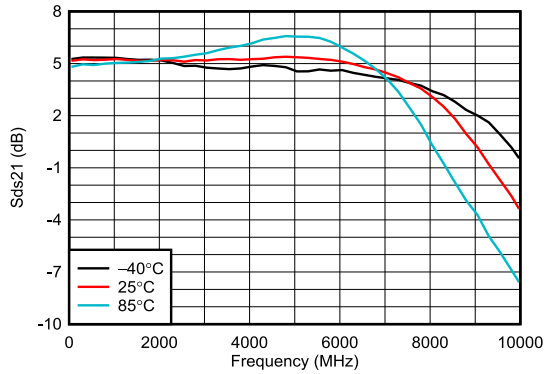

$P_{\text{IN}} = -20\text{dBm}$ with 50Ω source at all excited ports, nonexcited ports are terminated with 50Ω

Figure 6-51. Power Gain (Sds21) Across Temperature

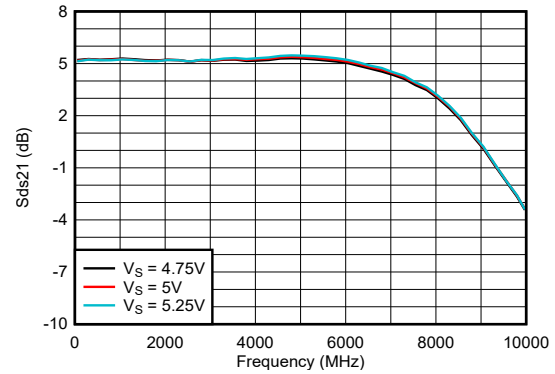

$P_{\text{IN}} = -20\text{dBm}$ with 50Ω source at all excited ports, nonexcited ports are terminated with 50Ω

Figure 6-52. Power Gain (Sds21) Across Supply Voltage

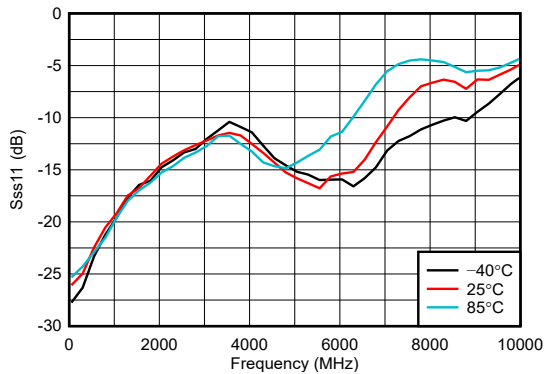

$P_{\text{IN}} = -20\text{dBm}$ with 50Ω source at all excited ports, nonexcited ports are terminated with 50Ω

Figure 6-53. Input Return Loss (Sss11) Across Temperature

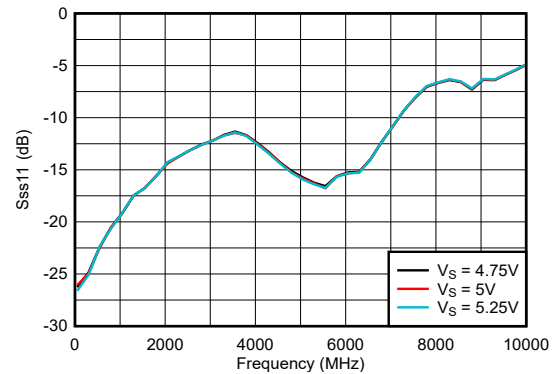

$P_{\text{IN}} = -20\text{dBm}$ with 50Ω source at all excited ports, nonexcited ports are terminated with 50Ω

Figure 6-54. Input Return Loss (Sss11) Across Supply Voltage

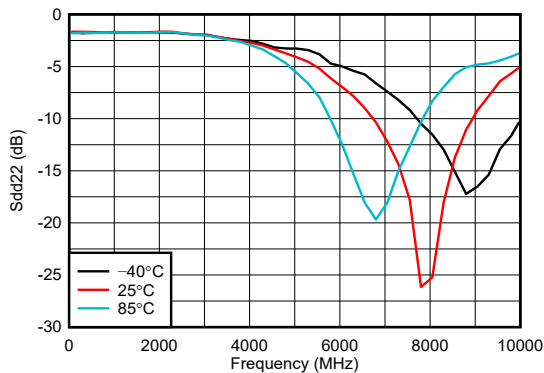

$P_{\text{IN}} = -20\text{dBm}$ with 50Ω source at all excited ports, nonexcited ports are terminated with 50Ω

Figure 6-55. Output Return Loss (Sdd22) Across Temperature

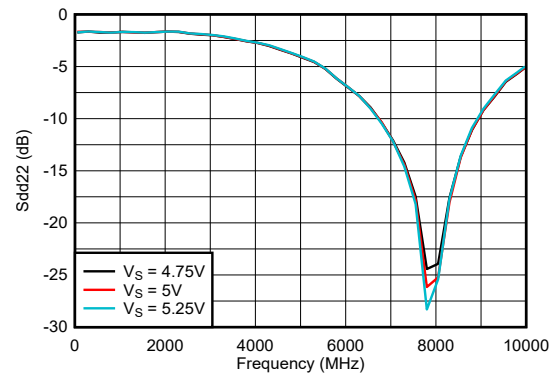

$P_{\text{IN}} = -20\text{dBm}$ with 50Ω source at all excited ports, nonexcited ports are terminated with 50Ω

Figure 6-56. Output Return Loss (Sdd22) Across Supply Voltage

6.9 Typical Characteristics: S2D Configuration (continued)

at $T_A = 25^\circ\text{C}$, $V_{S+} = 5\text{V}$, $V_{S-} = 0\text{V}$, floating VO_{CM}, PD, and MODE pins, $V_{\text{ICM}} = \text{mid-supply}$, S2D ac-coupled input/output configuration with $R_{\text{TERM}} = 50\Omega$, $Z_S = 50\Omega$, $Z_L = 100\Omega$ (see Figure 8-1), input and outputs de-embedded up to the device pins, and ambient temperatures shown (unless otherwise noted)

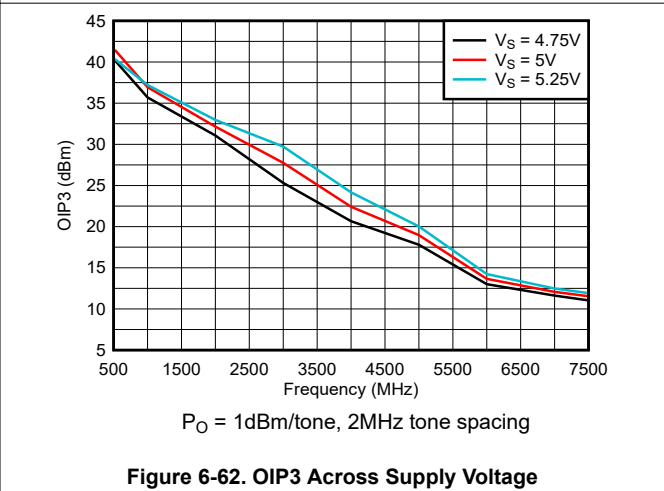
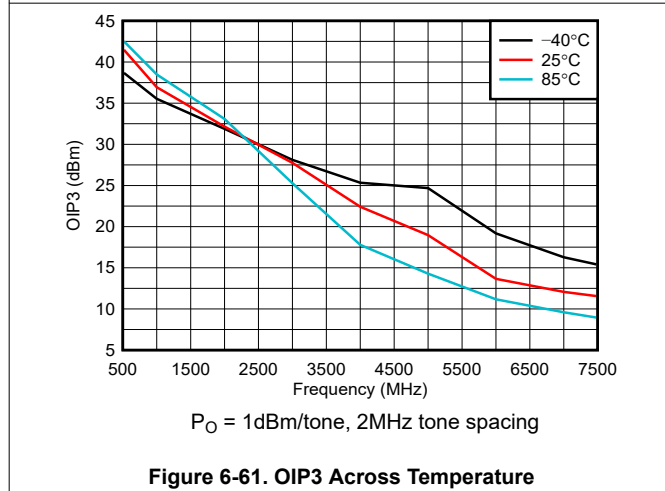
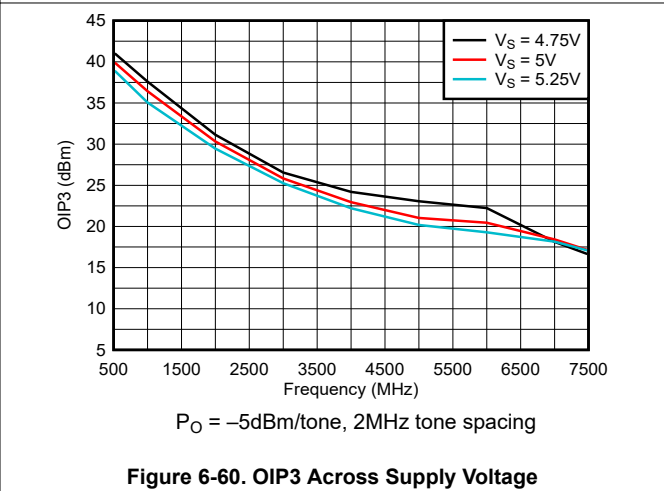
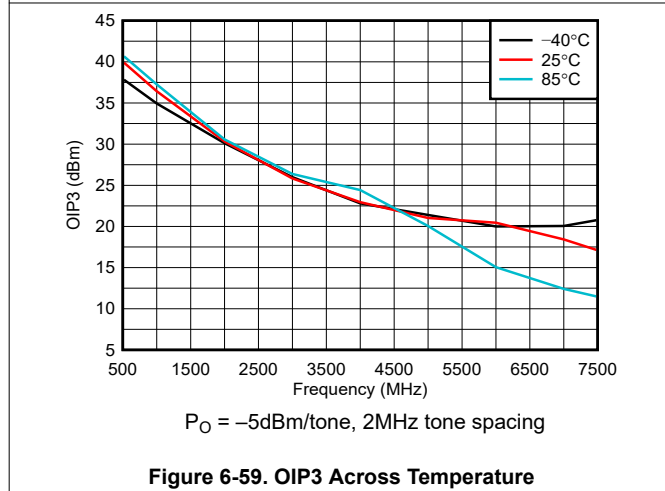
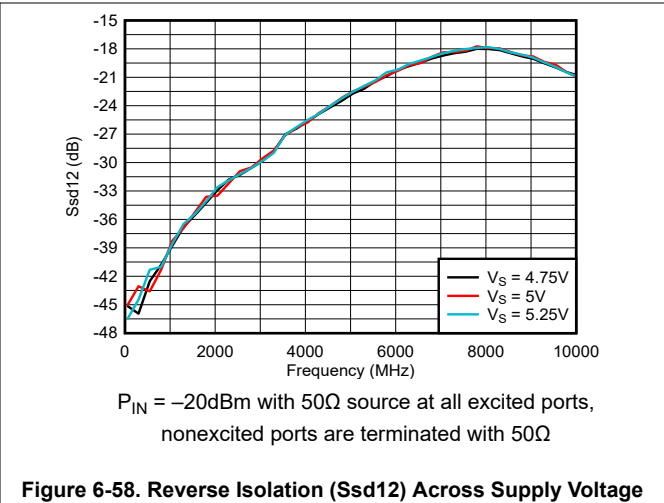
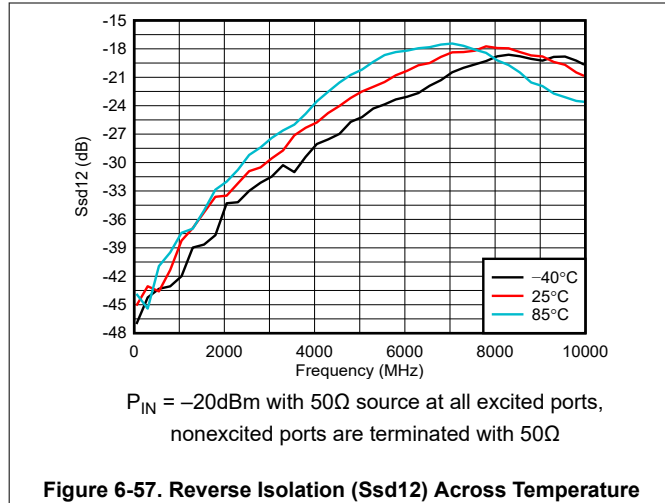

6.9 Typical Characteristics: S2D Configuration (continued)

at $T_A = 25^\circ\text{C}$, $V_{S+} = 5\text{V}$, $V_{S-} = 0\text{V}$, floating VO_{CM}, PD, and MODE pins, $V_{\text{ICM}} = \text{mid-supply}$, S2D ac-coupled input/output configuration with $R_{\text{TERM}} = 50\Omega$, $Z_S = 50\Omega$, $Z_L = 100\Omega$ (see Figure 8-1), input and outputs de-embedded up to the device pins, and ambient temperatures shown (unless otherwise noted)

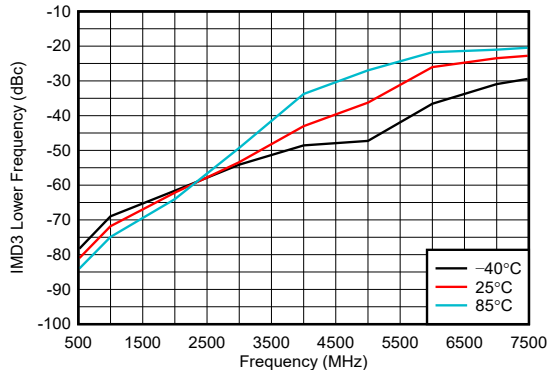

At $(2f_1 - f_2)$ frequency where $f_1 < f_2$,
 $P_O = 1\text{dBm/tone}$, 2MHz tone spacing

Figure 6-63. IMD3 Lower Across Temperature

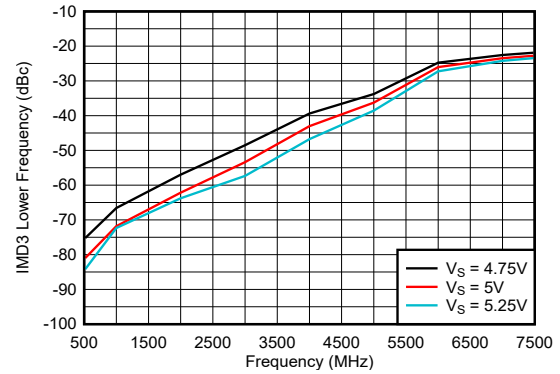

At $(2f_1 - f_2)$ frequency where $f_1 < f_2$,
 $P_O = 1\text{dBm/tone}$, 2MHz tone spacing

Figure 6-64. IMD3 Lower Across Supply Voltage

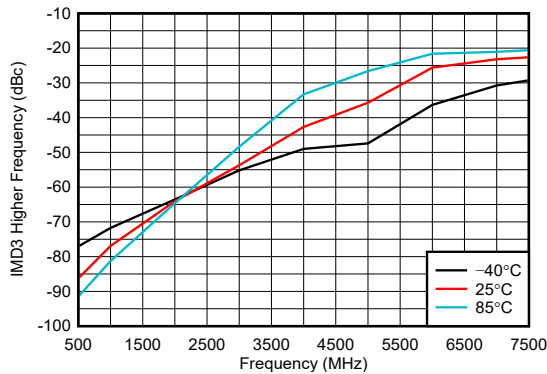

At $(2f_2 - f_1)$ frequency where $f_1 < f_2$,
 $P_O = 1\text{dBm/tone}$, 2MHz tone spacing

Figure 6-65. IMD3 Higher Across Temperature

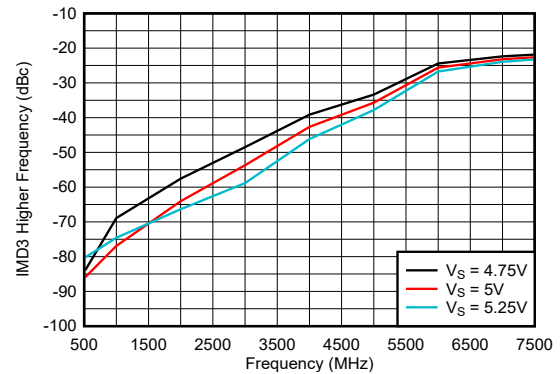

At $(2f_2 - f_1)$ frequency where $f_1 < f_2$,
 $P_O = 1\text{dBm/tone}$, 2MHz tone spacing

Figure 6-66. IMD3 Higher Across Supply Voltage

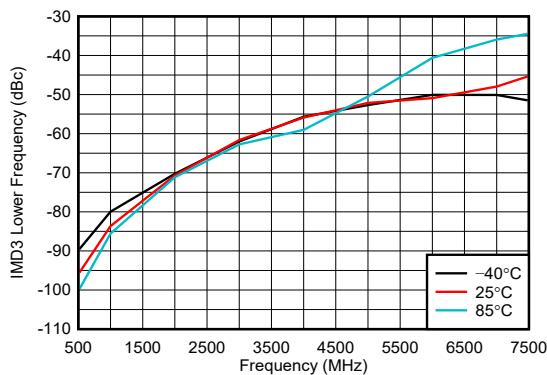

At $(2f_1 - f_2)$ frequency where $f_1 < f_2$,
 $P_O = -5\text{dBm/tone}$, 2MHz tone spacing

Figure 6-67. IMD3 Lower Across Temperature

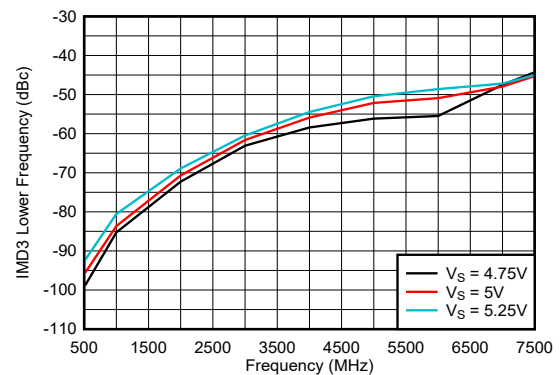

At $(2f_1 - f_2)$ frequency where $f_1 < f_2$,
 $P_O = -5\text{dBm/tone}$, 2MHz tone spacing

Figure 6-68. IMD3 Lower Across Supply Voltage

6.9 Typical Characteristics: S2D Configuration (continued)

at $T_A = 25^\circ\text{C}$, $V_{S+} = 5\text{V}$, $V_{S-} = 0\text{V}$, floating VO_{CM}, PD, and MODE pins, $V_{\text{ICM}} = \text{mid-supply}$, S2D ac-coupled input/output configuration with $R_{\text{TERM}} = 50\Omega$, $Z_S = 50\Omega$, $Z_L = 100\Omega$ (see Figure 8-1), input and outputs de-embedded up to the device pins, and ambient temperatures shown (unless otherwise noted)

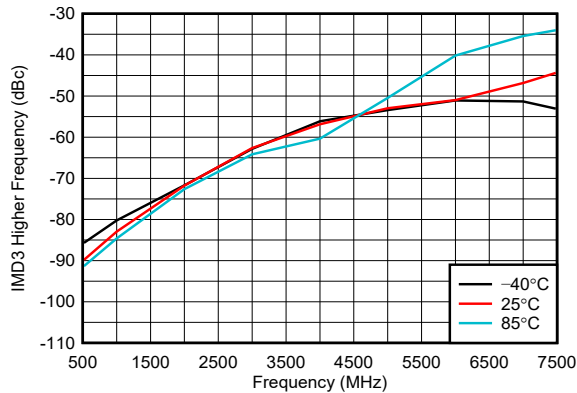

At $(2f_2 - f_1)$ frequency where $f_1 < f_2$,
 $P_O = -5\text{dBm/tone}$, 2MHz tone spacing

Figure 6-69. IMD3 Higher Across Temperature

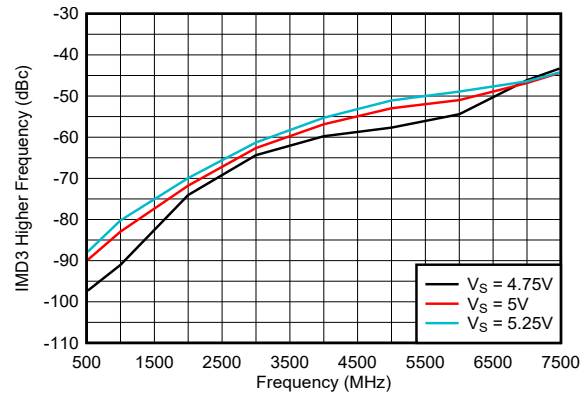

At $(2f_2 - f_1)$ frequency where $f_1 < f_2$,
 $P_O = -5\text{dBm/tone}$, 2MHz tone spacing

Figure 6-70. IMD3 Higher Across Supply Voltage

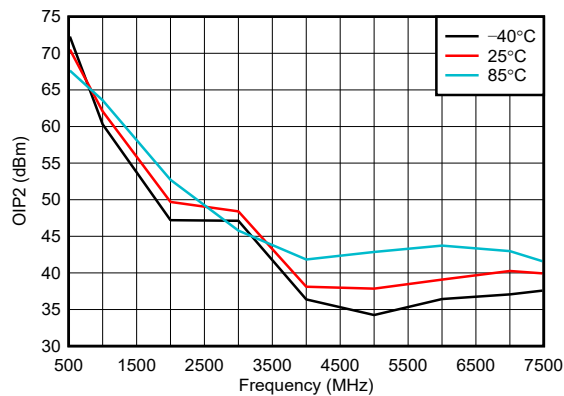

$P_O = -5\text{dBm/tone}$, 2MHz tone spacing

Figure 6-71. OIP2 Across Temperature

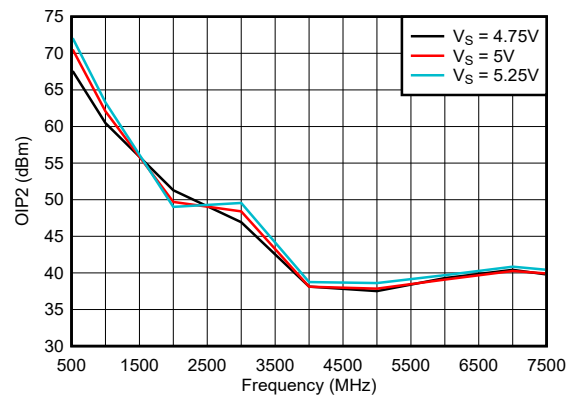

$P_O = -5\text{dBm/tone}$, 2MHz tone spacing

Figure 6-72. OIP2 Across Supply Voltage

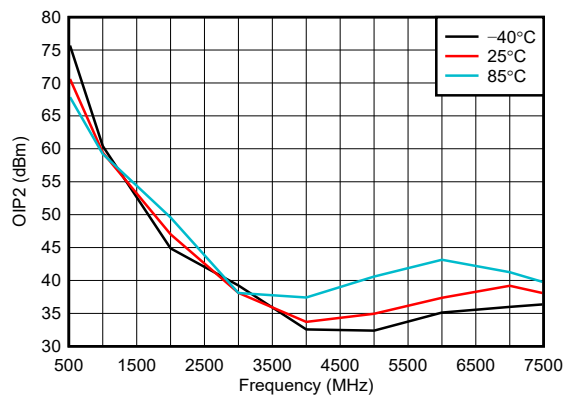

$P_O = 1\text{dBm/tone}$, 2MHz tone spacing

Figure 6-73. OIP2 Across Temperature

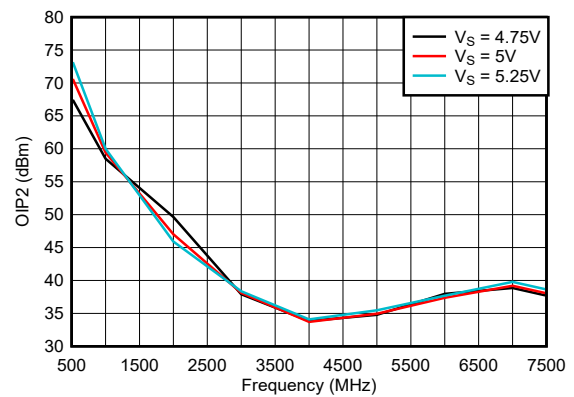

$P_O = 1\text{dBm/tone}$, 2MHz tone spacing

Figure 6-74. OIP2 Across Supply Voltage

6.9 Typical Characteristics: S2D Configuration (continued)

at $T_A = 25^\circ\text{C}$, $V_{S+} = 5\text{V}$, $V_{S-} = 0\text{V}$, floating VO_{CM}, PD, and MODE pins, $V_{\text{ICM}} = \text{mid-supply}$, S2D ac-coupled input/output configuration with $R_{\text{TERM}} = 50\Omega$, $Z_S = 50\Omega$, $Z_L = 100\Omega$ (see Figure 8-1), input and outputs de-embedded up to the device pins, and ambient temperatures shown (unless otherwise noted)

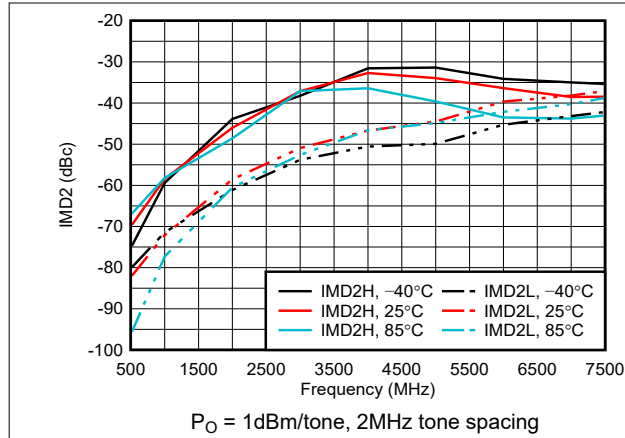

Figure 6-75. IMD2 Across Temperature

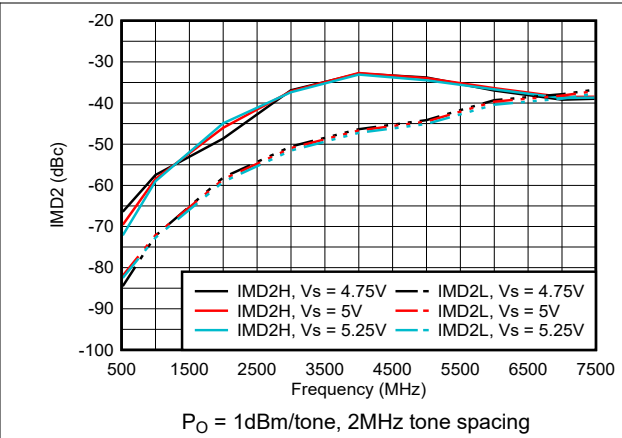

Figure 6-76. IMD2 Across Supply Voltage

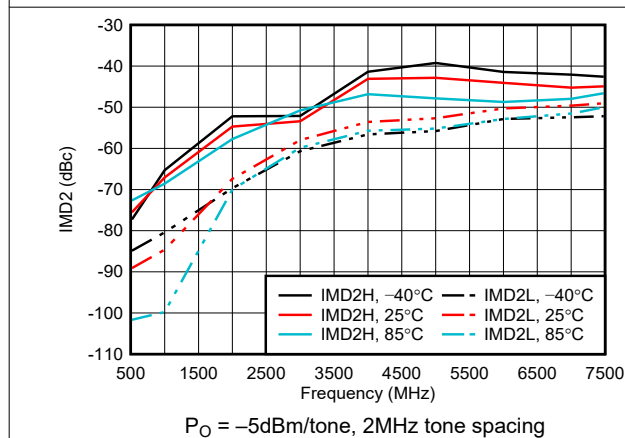

Figure 6-77. IMD2 Across Temperature

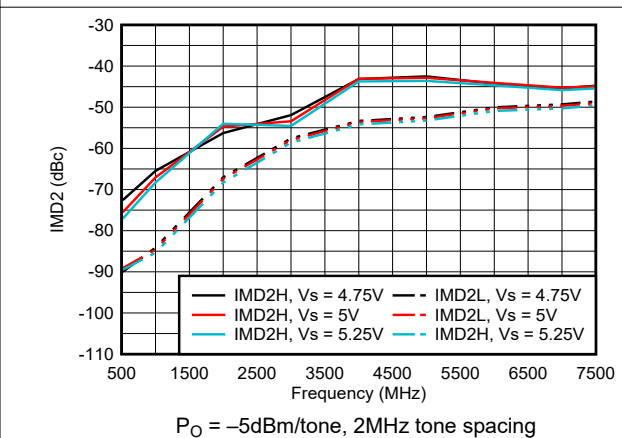

Figure 6-78. IMD2 Across Supply Voltage

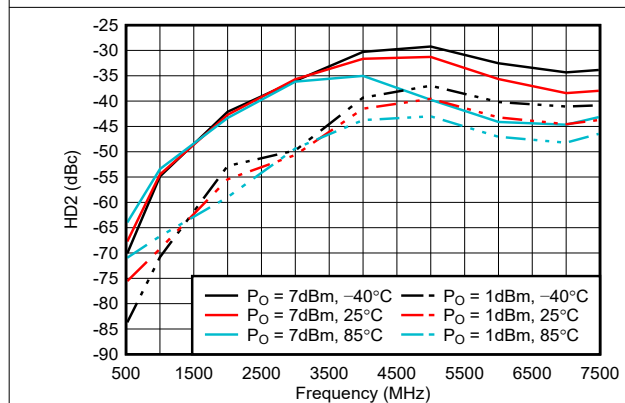

Figure 6-79. HD2 Across Output Power and Temperature

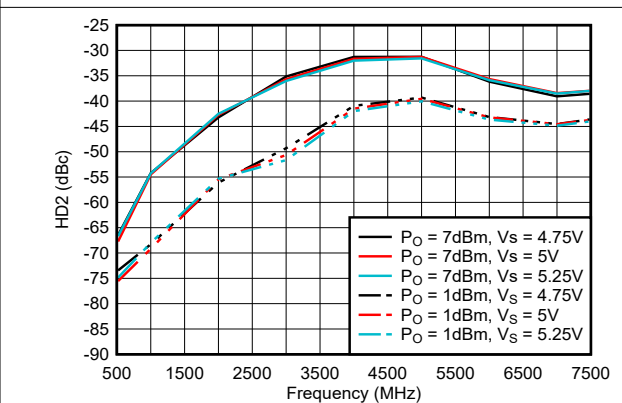

Figure 6-80. HD2 Across Output Power and Supply Voltage

6.9 Typical Characteristics: S2D Configuration (continued)

at $T_A = 25^\circ\text{C}$, $V_{S+} = 5\text{V}$, $V_{S-} = 0\text{V}$, floating VO_{CM}, PD, and MODE pins, $V_{\text{ICM}} = \text{mid-supply}$, S2D ac-coupled input/output configuration with $R_{\text{TERM}} = 50\Omega$, $Z_S = 50\Omega$, $Z_L = 100\Omega$ (see Figure 8-1), input and outputs de-embedded up to the device pins, and ambient temperatures shown (unless otherwise noted)

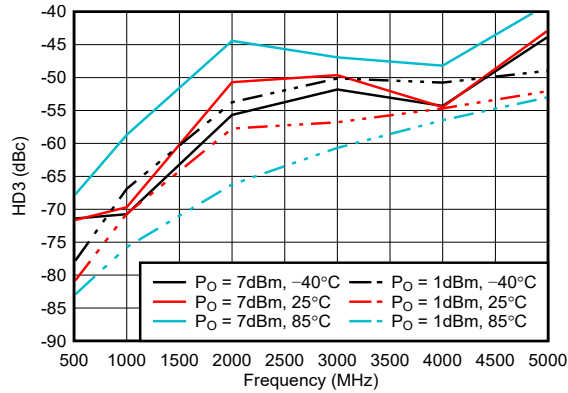

Figure 6-81. HD3 Across Output Power and Temperature

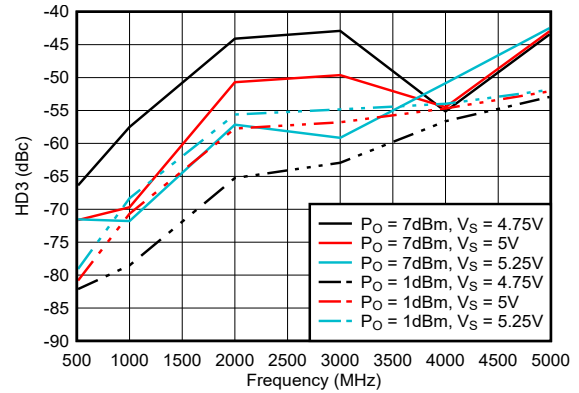

Figure 6-82. HD3 Across Output Power and Supply Voltage

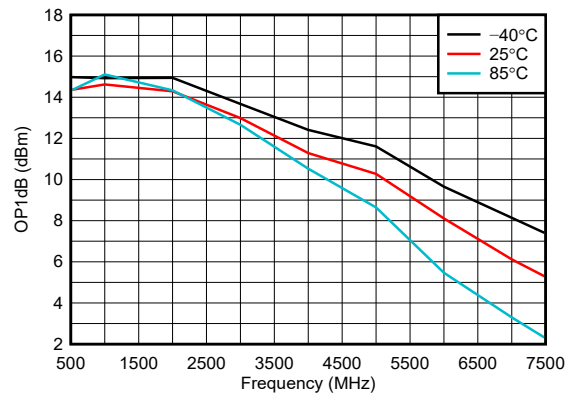

Figure 6-83. OP1dB Across Temperature

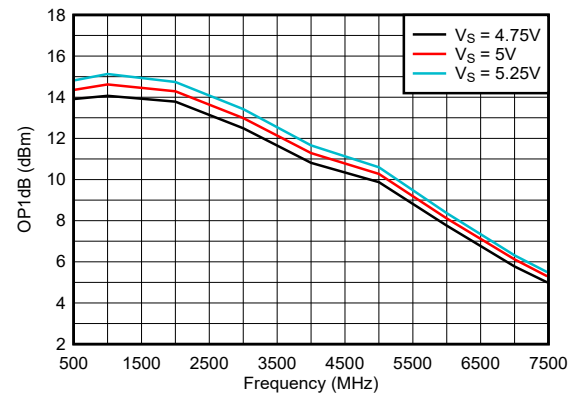

Figure 6-84. OP1dB Across Supply Voltage

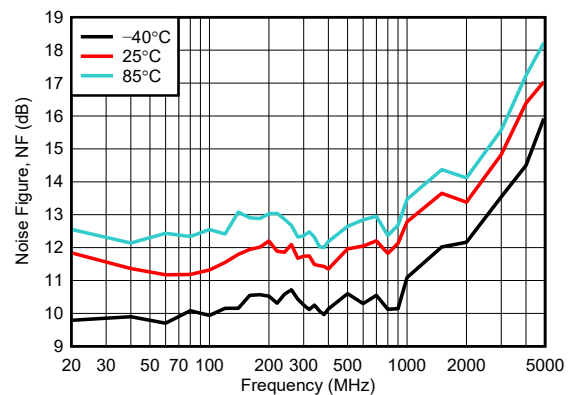

Figure 6-85. Noise Figure Across Temperature

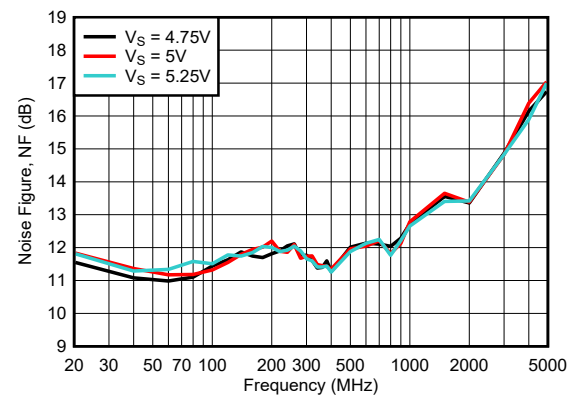

Figure 6-86. Noise Figure Across Supply Voltage

6.9 Typical Characteristics: S2D Configuration (continued)

at $T_A = 25^\circ\text{C}$, $V_{S+} = 5\text{V}$, $V_{S-} = 0\text{V}$, floating VO_{CM}, PD, and MODE pins, $V_{\text{ICM}} = \text{mid-supply}$, S2D ac-coupled input/output configuration with $R_{\text{TERM}} = 50\Omega$, $Z_S = 50\Omega$, $Z_L = 100\Omega$ (see Figure 8-1), input and outputs de-embedded up to the device pins, and ambient temperatures shown (unless otherwise noted)

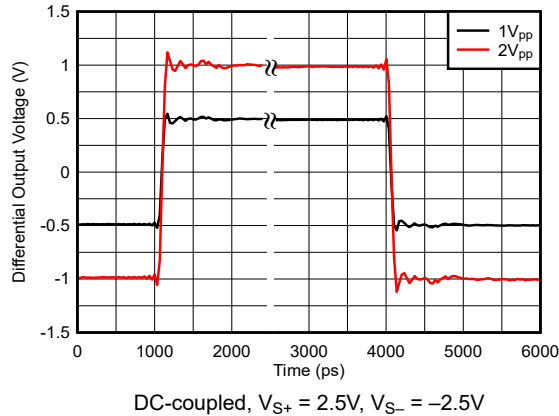

Figure 6-87. Step Response

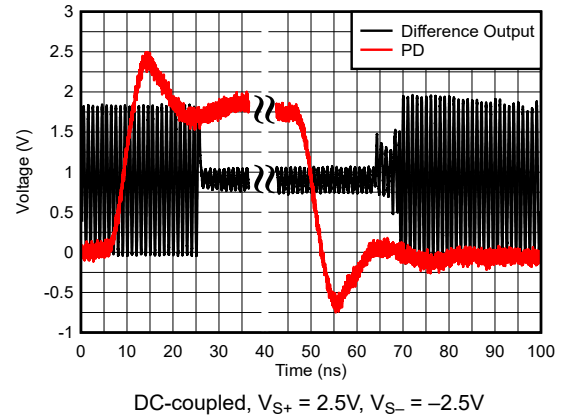

Figure 6-88. Power Up and Power Down Timing

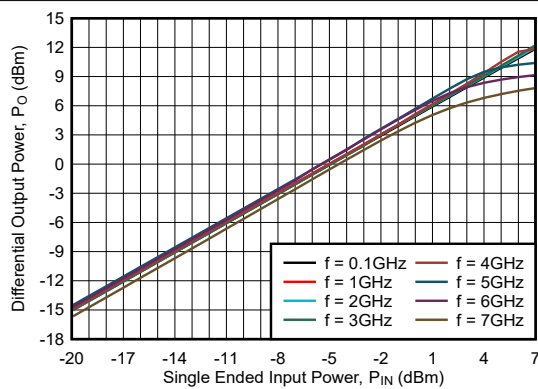

Figure 6-89. Differential Output Power Across Single Ended Input Power

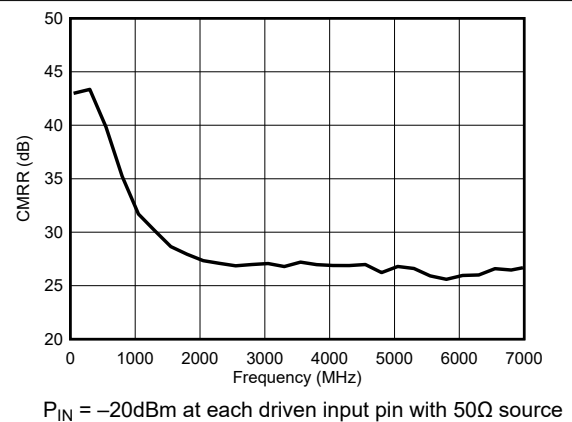

Figure 6-90. Common-Mode Rejection Ratio (CMRR)

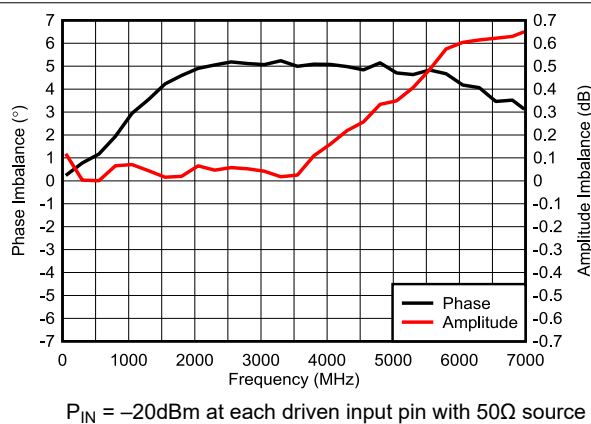

Figure 6-91. Amplitude and Phase Imbalance

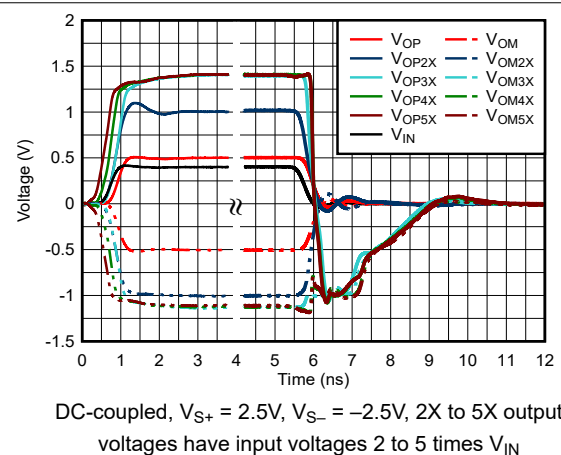

Figure 6-92. Overdrive Recovery Response

7 Detailed Description

7.1 Overview

The TRF1305A1, TRF1305B1, and TRF1305C1 (TRF1305x1) devices are single-channel, high-performance fully differential RF amplifiers optimized for very wideband signals. This device family is primarily designed to interface with high-speed and RF data converters that often require differential input (ADCs) and output (DACs) signaling. The TRF1305x1 can be dc or ac coupled, and configured as single-ended input and differential output (S2D) or differential input and differential output (D2D). The devices feature an output common-mode pin (VOCM) that allows the flexibility to set a desired common-mode output voltage. The amplifier allows the data converters to interface with a dc-coupled IQ demodulator or modulator if used in a direct conversion system. The TRF1305x1 family comes in three fixed power gain variants (15dB, 10dB, and 5dB), and has a closed-loop feedback-amplifier architecture.

The devices are powered using two-rail supplies with a typical differential voltage of 5V between the positive and negative supplies, and usable in split- or single-supply configurations. A power-down feature is also available that allows the amplifier to be powered down.

The output of the amplifiers is low impedance. Use appropriate external series termination or resistive pad to match to an arbitrary impedance.

7.2 Functional Block Diagram

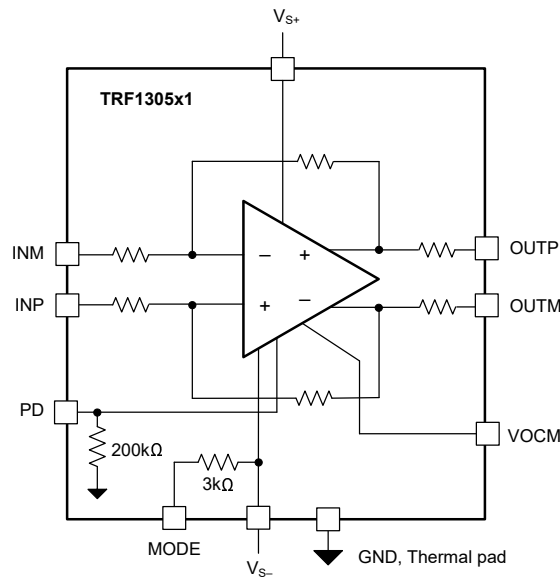

7.3 Feature Description

The TRF1305x1 includes the following key features:

- Two-rail floating supply with supply-independent thermal pad
 - Connect the thermal pad to GND
 - RF signals and PD pin are referenced to GND
- Single-supply or split-supply operation
- Supports single-ended and differential input configurations
- Performance-optimized preset fixed-gain variants
- Output common-mode control
- MODE pin: V_{ICM} range extension closer to V_{S+} or V_{S-} modes
- Digital-logic-controllable power-down option

7.3.1 Fully Differential RF Amplifier

The TRF1305x1 are voltage-feedback fully differential amplifiers (FDAs) with wide bandwidth. The amplifiers are designed for a differential power gain of 15dB, 10dB, or 5dB depending on the device variant. These amplifiers have excellent time-domain specifications with high slew rate, high input and output common-mode ranges, and fast transient settling time.

The output average voltage (common-mode) of the FDA device is controlled by a separate common-mode loop. The target output common-mode voltage is set by the VO_{CM} input pin.

7.3.2 Output Common-Mode Control

Figure 7-1 shows a functional diagram of the output common-mode control. Internally, the VO_{CM} pin potential is set by the LDO output voltage that is equal to $V_{S-} + 2.5V$ connected through a 2.5k Ω resistor.

Floating the VO_{CM} pin is allowed. The output common-mode voltage at the output pins, O_{UTP} and O_{UTM}, defaults to the LDO output voltage of $V_{S-} + 2.5V$ when VO_{CM} pin is floated. Floating the VO_{CM} pin results in a V_{OCM} voltage equal to midsupply when $V_S = 5V$. If the VO_{CM} pin is driven, then drive the pin from a low-impedance source. Limit the value of R_{OCM} to less than 25 Ω for accurate reflection of the forced V_{OCM} voltage at the device outputs.

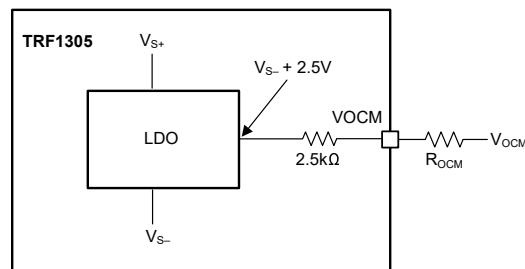

Figure 7-1. Output Common-Mode Control

7.3.3 Internal Resistor Configuration

Figure 7-2 shows the internal resistor configurations of TRF1305x1. Table 7-1 provides the values of these resistors for different gain variants.

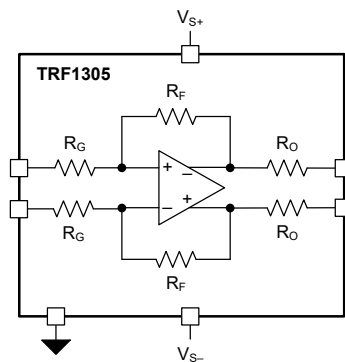

Figure 7-2. TRF1305x1 Internal Resistor Configuration

Table 7-1. Resistor Values

DEVICE NAME	GAIN (dB)	R _G (Ω)	R _F (Ω)	R _O (Ω)
TRF1305A1	15	6.25	258	4
TRF1305B1	10	12.5	161	4
TRF1305C1	5	17	97	4

7.4 Device Functional Modes

7.4.1 MODE Pin

The TRF1305x1 have additional useful features that can be configured using the MODE pin. To select the device mode, either connect a $\pm 2\%$ maximum tolerance pullup resistor between the MODE pin and V_{S+} , or force a voltage on the MODE pin. Internally, the MODE pin is referenced to V_{S-} through a $3k\Omega$ resistor (see also [Section 7.2](#)).

[Table 7-2](#) provides the value of the pullup resistor for each mode, the expected voltage (V_{MODE}) at the MODE pin when the pullup resistor is used, or the necessary V_{MODE} voltage to set the device mode and the mode configurations. The V_{MODE} voltage thresholds are approximately midway between the typical V_{MODE} voltage of the adjacent mode. If mode functionality is used, use a decoupling capacitor on the MODE pin.

Table 7-2. MODE Pin Configuration

MODE NUMBER	PULLUP RESISTOR TO V_{S+} ($\pm 2\%$ MAXIMUM TOLERANCE)	MODE PIN VOLTAGE, V_{MODE} (V)	V_{ICM} RANGE EXTENSION ⁽¹⁾
0	OPEN	V_{S-}	Default V_{ICM} range
1	28.7k Ω	$V_{S-} + 0.5V$	Low side, extends V_{ICM} range closer to V_{S-}
2	12.7k Ω	$V_{S-} + 1V$	High side, extends V_{ICM} range closer to V_{S+}
N/A	Do not use pullup resistor < 10k Ω , do not set $V_{MODE} > V_{S-} + 1.15V$		

(1) Only available in D2D configuration.

To switch the mode without turning the supplies off, use a switch or MUX connected between the pullup resistor options and V_{S+} , or force a mode-appropriate V_{MODE} voltage. However, best practice is to power down the device using the power-down feature between mode changes; see also [Section 7.4.2](#). The low-side V_{ICM} range extension mode sources current, and the high-side sinks current; see also the following section, *Input Common-Mode Extension*. Ensure that the external circuitry is ready to sink or source these currents before the device is put in the active mode from the powered-down state.

7.4.1.1 Input Common-Mode Extension

The TRF1305C1 supports a V_{ICM} voltage closer to either V_{S+} or V_{S-} voltage than the default specified input common-mode range in the *Electrical Characteristics*, when configured in one of the V_{ICM} extension modes. The V_{ICM} extension mode can only be used in D2D configuration.

When configured in the low-side V_{ICM} extension mode, TRF1305C1 supports a 500mV lower input common-mode voltage than the default option. For example, the lower limit of V_{ICM} voltage range extends from a default value of $V_{S-} + 1.5V$ to $V_{S-} + 1V$ for the TRF1305C1 variant, and the higher limit also shifts lower from a default value of $V_{S-} + 3.5V$ to $V_{S-} + 3V$. At the lowest V_{ICM} voltage, approximately 15mA current must be sunk by the external circuitry connected to the INP and INM pins.

When configured in the high-side V_{ICM} extension mode, TRF1305C1 supports a 500mV higher input common-mode voltage than the default option. For example, the higher limit of V_{ICM} voltage range extends from a default value of $V_{S-} + 3.5V$ to $V_{S-} + 4V$ for the TRF1305C1 variant, and the lower limit also shifts up from a default of $V_{S-} + 1.5V$ to $V_{S-} + 2V$. At the highest V_{ICM} voltage, approximately 15mA current must be sourced by the external circuitry connected to the INP and INM pins.

Either resistors connected to supplies or external current sources are usable to sink or source the currents flowing out of or into the INP and INM pins during the low-side or high-side V_{ICM} extension modes, respectively.

7.4.2 Power-Down Mode

The TRF1305x1 have two bias modes, active and power-down, that are controlled by the voltage on the PD pin. The PD pin is referenced to GND through a $200k\Omega$ resistor; see also [Section 7.2](#). If the $V_{S+} \geq 3.3V$ configuration is used, ensure that the PD voltage does not exceed the *Absolute Maximum Ratings* in case the high PD voltage is derived from V_{S+} .

Both 1.8V and 3.3V digital logic are supported for power-down control.

8 Application and Implementation

Note

Information in the following applications sections is not part of the TI component specification, and TI does not warrant its accuracy or completeness. TI's customers are responsible for determining suitability of components for their purposes, as well as validating and testing their design implementation to confirm system functionality.

8.1 Application Information

8.1.1 Input and Output Interface Considerations

8.1.1.1 Single-Ended Input

In the single-ended input configuration, one of the amplifier input pins is driven from a source while the other input is terminated with an external resistor. [Figure 8-1](#) shows an ac-coupled, single-ended input configuration driven from and matched to a 50Ω source. [Figure 8-1](#) shows how the non-driven INM pin is terminated with a 50Ω external resistor to match to a source with the same 50Ω impedance at the INP pin.

To configure the design in [Figure 8-1](#) for single-ended, dc-coupled input, replace the ac-coupling capacitors with shorts, and externally bias both INP and INM pins to a voltage close to the mid-supply or within the common-mode limits of the amplifier.

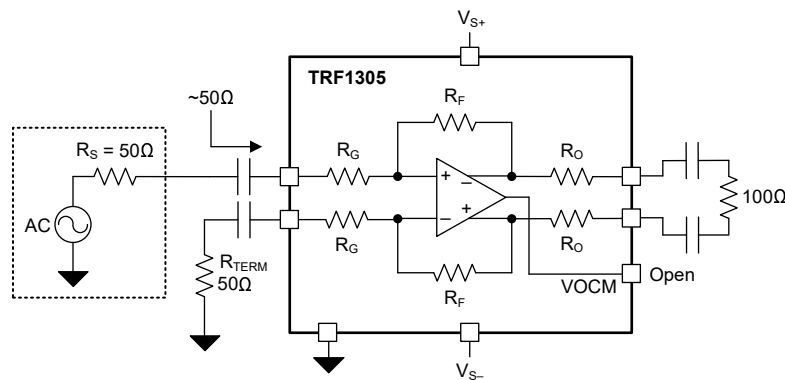

Figure 8-1. AC-Coupled, Single-Ended Input Matched to a 50Ω Source

8.1.1.2 Differential Input

[Figure 8-2](#) shows how a simple network consisting of three resistors is used to match the differential input to a 100Ω differential source. Though the 1kΩ shunt resistor, R_{IN_SH} , does not have any impact at dc to low frequencies, the resistor is necessary to get the full wideband performance from TRF1305x1. [Figure 8-3](#) shows the configuration for ac-coupled differential input designs. The resistors values shown in [Figure 8-2](#) and [Figure 8-3](#) work for all gain versions of the TRF1305x1 for an 100Ω input match to a 100Ω differential source.

Use small foot-print resistors (0201 preferred), and RF quality for high-frequency matching.

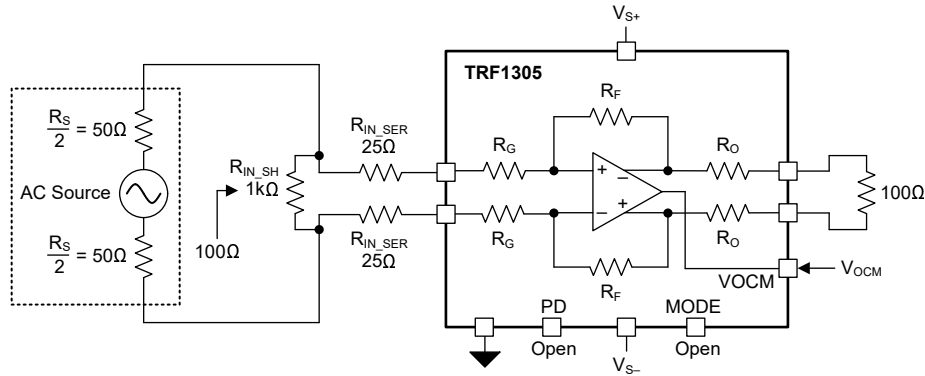

Figure 8-2. DC-Coupled Differential Input Matched to a 100Ω Differential Source

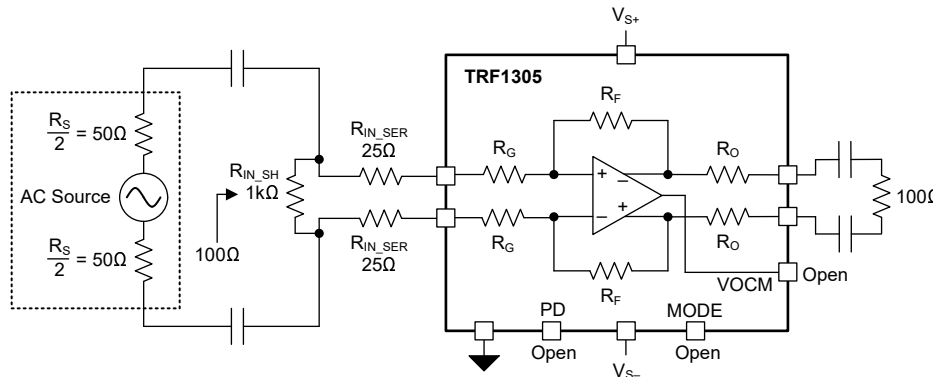

Figure 8-3. AC-Coupled Differential Input Matched to a 100Ω Differential Source

8.1.1.3 DC-Coupling Considerations

The TRF1305x1 accept a wide range of input dc common-mode (CM) voltages. Take into consideration the dc current loading of the source when the TRF1305x1 is dc coupled at the input. Figure 8-4 shows that when the input CM voltage, V_{ICM} , is different than the output CM voltage, V_{OICM} , a net dc current flow from or to the source occurs. Equation 1 shows the relationship that the source or sink current, I_{ICM} , has with the input and output CM voltages:

$$I_{ICM} = \frac{(V_{OICM} - V_{ICM})}{(R_F + R_G)} \quad (1)$$

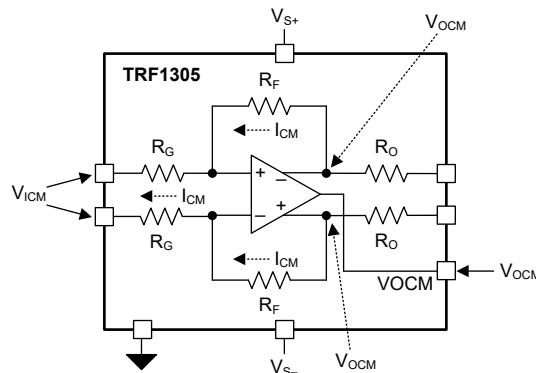

Figure 8-4. Net DC Current Flow When Input and Output Common-Mode Voltages are not Equal

8.1.2 Gain Adjustment With External Resistors in a Differential Input Configuration

The TRF1305x1 allow minor gain adjustments by configuring the input external resistive network that is part of the differential input configuration. Figure 8-5 shows the external input network that comprises of a shunt resistor, R_{IN_SH} , and two series input resistors, R_{IN_SER} , connected to the input pins of the amplifier.

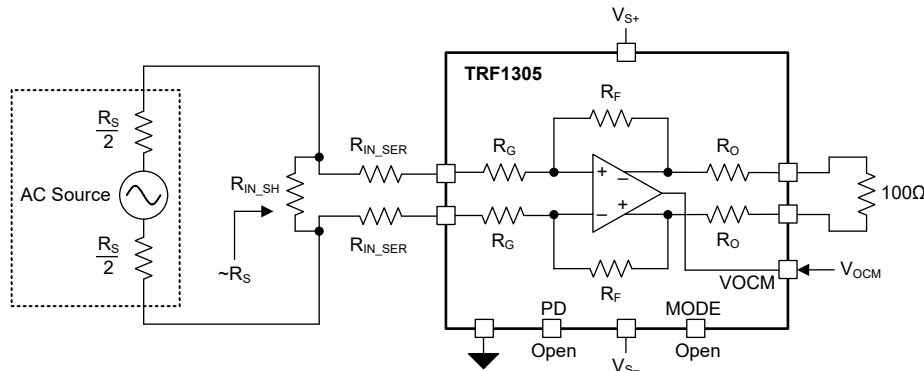

Figure 8-5. Gain Adjustment With External Resistor Network

Table 8-1 provides resistor configurations for a 100Ω differential source impedance.

Table 8-1. Resistor Table for $R_S = 100\Omega$

TRF1305C1		
POWER GAIN (dB)	R_{IN_SH} (Ω)	R_{IN_SER} (Ω)
5	1000	25
4	434	30
3	288	36
2	222	42
1	184	49
0	160	57

Use external resistive attenuation network only for small gain adjustments because there is a dB-to-dB noise figure degradation with the resistive attenuators. Use an amplifier version that requires minimal attenuation for achieving the overall gain.

8.2 Typical Application

8.2.1 TRF1305C1 as ADC Driver in a Zero-IF Receiver

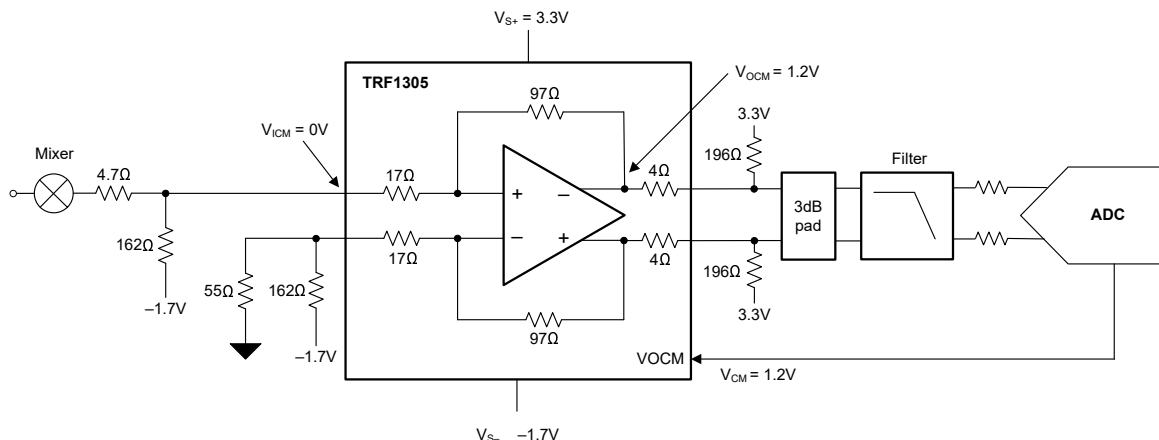

Figure 8-6. TRF1305C1 as ADC Driver in a Zero-IF Receiver

Consider a zero-IF (direct down conversion) application with an IQ demodulator interfaced to a pair of ADCs. In this case, the TRF1305C1 is used as an interface amplifier between the demodulator and the ADCs. The dc common-mode of the demodulator output and ADC input are different. The TRF1305C1 dc couples the demodulator to ADC without degrading the signal integrity of the signal chain.

8.2.1.1 Design Requirements

The primary design requirement for an IQ demodulator application is to interface a pair of passive mixers with an RF ADC. The mixers have a 0V common-mode voltage. The ADC requires an input common-mode voltage of 1.2V with full-scale swing of 1.35V_{PP}. Choose the power supplies, and design the input/output network for the TRF1305C1 as the ADC driver amplifier, to perform the dc level shifting and amplification function.

8.2.1.2 Detailed Design Procedure

The first step is to choose the TRF1305C1 supplies. Ensure that the midsupply voltage, $V_{MIDSUPPLY}$, is between the ADC common-mode (CM) voltage and the mixer CM voltage. $V_{MIDSUPPLY}$ is typically positioned closer to the ADC CM because the output CM range of the amplifier is less than the input CM range. Ensure that the dc of the signal at the input and output of the amplifier are within the valid operating common-mode voltage range. Use the MODE pin for cases where an extended range of the input CM is required.

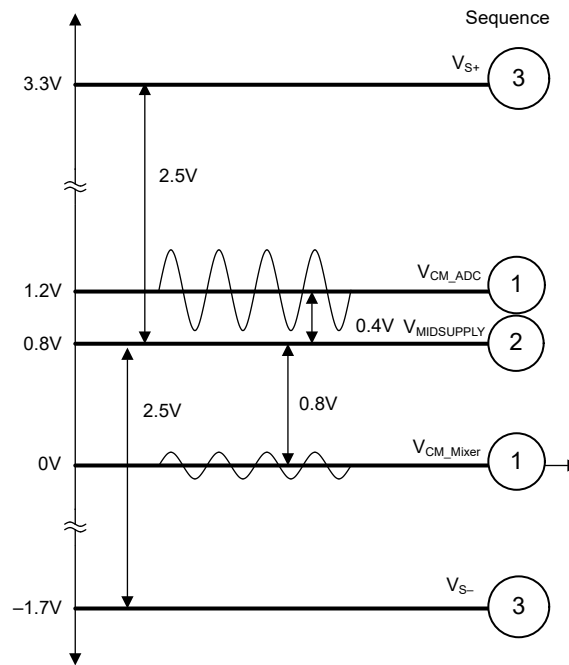

Figure 8-7. Choosing Supply Voltages With Given Common-Mode Voltages

Figure 8-7 shows how $V_{MIDSUPPLY}$ is chosen to be 0.8V, so that the amplifier input has a CM offset from $V_{MIDSUPPLY}$ of 0.8V and output has a CM offset from $V_{MIDSUPPLY}$ of 0.4V ($1.2V - 0.8V$). The CM offsets are within the valid common-mode range of the amplifier, so the supplies of the TRF1305C1 are chosen to be $V_{S+} = 3.3V$ ($0.8V + 2.5V$) and $V_{S-} = -1.7V$ ($0.8V - 2.5V$). Further optimization in the choice of supply is possible by selecting the input and output CM voltages for the best OIP3 performance. Section 8.2.1.3 has contour graphs that show OIP3 across input and output common-mode voltages.

The output CM is greater than the input CM; therefore, a net 10.5mA ($(1.2V - 0V) / (97\Omega + 17\Omega)$) dc current flows from the output to input through the internal feedback resistors. Depending on the choice of the passive mixer, this current can required to be sunk outside the mixer so that the bias conditions of the mixer are not disturbed. A 162 Ω pulldown resistor connected to the INP pin to $-1.7V$ supply is adequate. If the 10.5mA dc current is sourced entirely from the amplifier, then the output headroom can be affected. Therefore, source the current externally from the supply using a pair of pullup resistors connected to the amplifier outputs; 196 Ω pullup resistors from OUTP and OUTM to 3.3V are adequate.

The I-channel mixer output has a 50Ω port and is connected to the amplifier INP pin through a small (4.7Ω) series resistor. The INM pin is terminated to ground through a 68Ω resistor and to -1.7V through a 162Ω resistor. This configuration allows the amplifier to have the same input impedance at each of the INP and INM input pins. The impedance of the mixer is close to 43Ω and provides better than a -20dB return loss (theoretically). Be aware that there is some drop in the gain due to these resistor networks. The values of the resistors chosen in [Figure 8-6](#) are a good starting point; in practice, some adjustment is often needed to simultaneously meet the dc conditions and the RF performance.

At the amplifier output, a 3dB pad with a 100Ω differential impedance is used to match to the antialiasing filter with a 100Ω differential input impedance. The filter output is connected to ADC with appropriate matching. [Figure 8-6](#) only shows the I-channel; the Q-channel has an identical configuration.

8.2.1.3 Application Curves

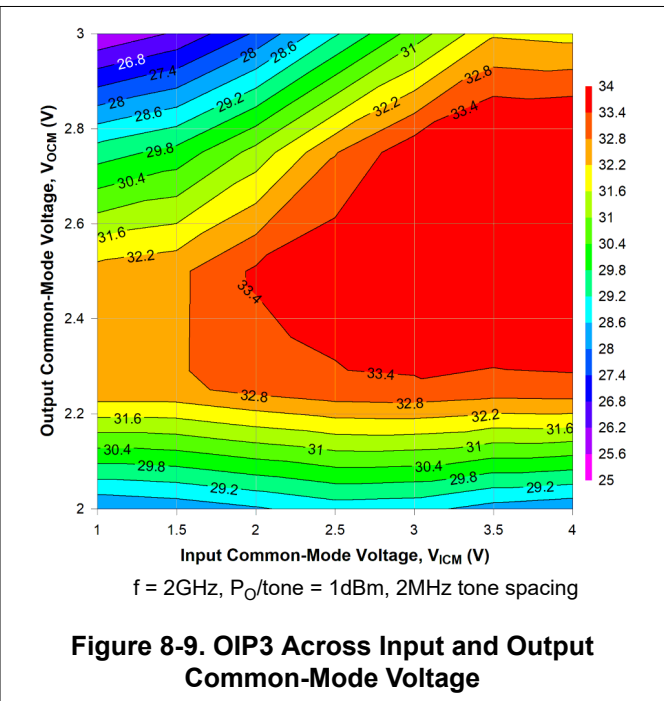
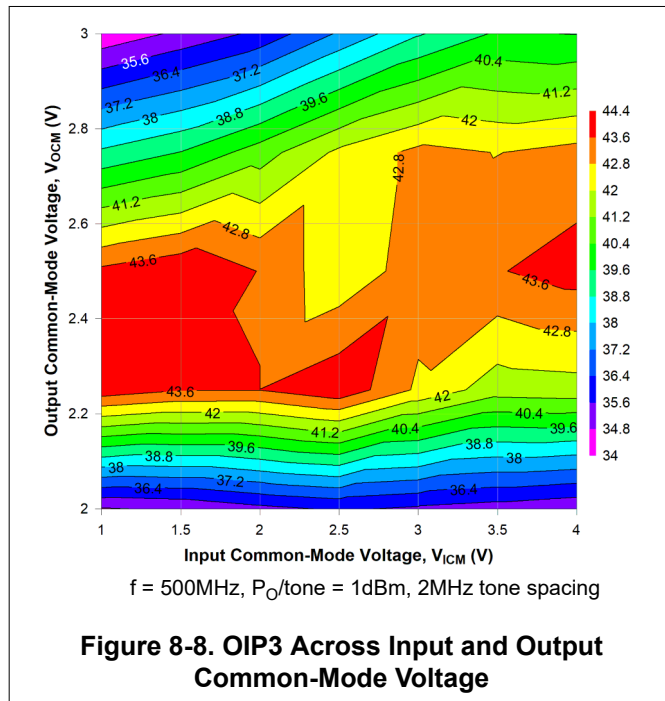

8.3 Power Supply Recommendations

8.3.1 Supply Voltages

For the TRF1305x1, the typical differential supply between VS+ and VS– is 5V. The VS+ and VS– supply pins can be floated with respect to ground within the specified range listed in the *Absolute Maximum Ratings* and *Recommended Operating Conditions*.

8.3.2 Single-Supply Operation

The VS– pin is connected to ground in the single-supply configuration. Single-supply operation is most convenient in ac-coupled configurations because the dc common-mode voltages of the source at the inputs and the driven circuit at the outputs are inherently decoupled.

8.3.3 Split-Supply Operation

In split-supply configuration, choose the V_{S+} and V_{S-} voltages to be within the ranges specified in the *Absolute Maximum Ratings* and *Recommended Operating Conditions*. The TRF1305x1 allows choosing negative voltages for the V_{S-} supply, thereby allowing the flexibility to choose input and output common-mode voltages according to the input network and output network requirements.

8.3.4 Supply Decoupling

The VS+ and VS– supply pins are decoupled individually to ground using external capacitors. Place the decoupling capacitors close to the device supply pins.

8.4 Layout

8.4.1 Layout Guidelines

The TRF1305x1 devices are wideband closed-loop feedback amplifiers. When designing with wideband RF amplifiers that have high gain, take certain board layout precautions to maintain stability and optimized performance. Use a multilayer board to maintain signal integrity, power integrity, and thermal performance.

Route the RF input and output lines as grounded coplanar waveguide (GCPW) lines. Ground pins are the reference for the RF signals. Ensure that the second layer of the PCB has a continuous ground layer without any ground cutouts in the vicinity of the amplifier. To minimize phase imbalance, match the length of the output differential lines of both channels. Length matching the input traces is also important, especially if the input configuration is differential. Use small-footprint, passive components wherever possible.

For good heat dissipation, connect the device thermal pad to the board ground planes using thermal vias under the device. For improved heat dissipation, connect the device thermal pad to the top layer ground plane of the board.

8.4.1.1 Thermal Considerations

The TRF1305x1 are packaged in a WQFN-FCRLF package that has excellent thermal properties. Connect the thermal pads underneath the devices to the thermally dissipative ground plane on the board. For good thermal design, use thermal vias to connect the thermal pad plane on the top layer of the PCB to the ground planes in the inner layers.

8.4.2 Layout Example

Figure 8-10 shows an example layout for TRF1305x1 with a differential input configuration. Key areas are highlighted in the figure.

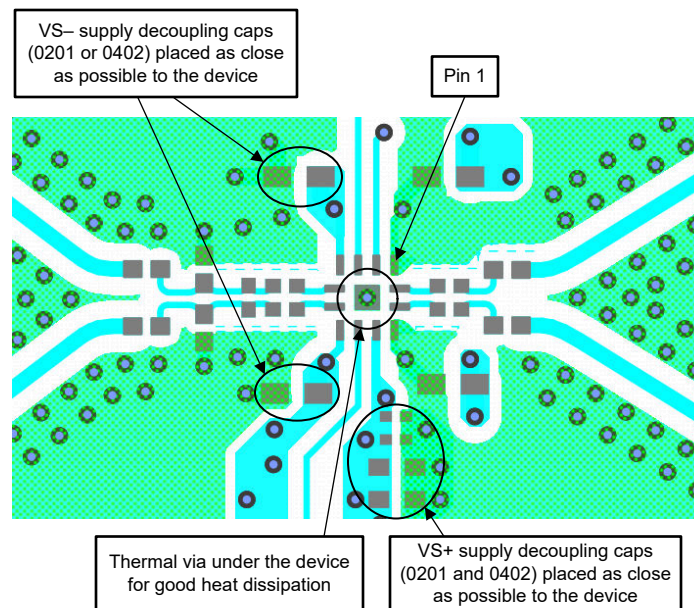

Figure 8-10. Layout Example: TRF1305x1 With Differential Input

The TRF1305C1 can be evaluated using EVM boards that can be ordered from the [TRF1305C1](#) product folder. For more information about the evaluation board construction and test setup, see the [TRF1305x1 EVM User's Guide](#).

9 Device and Documentation Support

9.1 Documentation Support

9.1.1 Related Documentation

For related documentation, see the following:

- Texas Instruments, [TRF1305x1-D2D EVM User's Guide](#)

9.2 Receiving Notification of Documentation Updates

To receive notification of documentation updates, navigate to the device product folder on [ti.com](#). Click on *Notifications* to register and receive a weekly digest of any product information that has changed. For change details, review the revision history included in any revised document.

9.3 Support Resources

[TI E2E™ support forums](#) are an engineer's go-to source for fast, verified answers and design help — straight from the experts. Search existing answers or ask your own question to get the quick design help you need.

Linked content is provided "AS IS" by the respective contributors. They do not constitute TI specifications and do not necessarily reflect TI's views; see TI's [Terms of Use](#).

9.4 Trademarks

TI E2E™ is a trademark of Texas Instruments.

All trademarks are the property of their respective owners.

9.5 Electrostatic Discharge Caution



This integrated circuit can be damaged by ESD. Texas Instruments recommends that all integrated circuits be handled with appropriate precautions. Failure to observe proper handling and installation procedures can cause damage.

ESD damage can range from subtle performance degradation to complete device failure. Precision integrated circuits may be more susceptible to damage because very small parametric changes could cause the device not to meet its published specifications.

9.6 Glossary

[TI Glossary](#) This glossary lists and explains terms, acronyms, and definitions.

10 Revision History

NOTE: Page numbers for previous revisions may differ from page numbers in the current version.

DATE	REVISION	NOTES
July 2025	*	Initial Release

11 Mechanical, Packaging, and Orderable Information

The following pages include mechanical, packaging, and orderable information. This information is the most current data available for the designated devices. This data is subject to change without notice and revision of this document. For browser-based versions of this data sheet, refer to the left-hand navigation.

PACKAGING INFORMATION

Orderable part number	Status (1)	Material type (2)	Package Pins	Package qty Carrier	RoHS (3)	Lead finish/ Ball material (4)	MSL rating/ Peak reflow (5)	Op temp (°C)	Part marking (6)
TRF1305C1RPVR	Active	Production	WQFN-HR (RPV) 12	3000 LARGE T&R	Yes	NIPDAU	Level-2-260C-1 YEAR	-40 to 105	135C

(1) **Status:** For more details on status, see our [product life cycle](#).

(2) **Material type:** When designated, preproduction parts are prototypes/experimental devices, and are not yet approved or released for full production. Testing and final process, including without limitation quality assurance, reliability performance testing, and/or process qualification, may not yet be complete, and this item is subject to further changes or possible discontinuation. If available for ordering, purchases will be subject to an additional waiver at checkout, and are intended for early internal evaluation purposes only. These items are sold without warranties of any kind.

(3) **RoHS values:** Yes, No, RoHS Exempt. See the [TI RoHS Statement](#) for additional information and value definition.

(4) **Lead finish/Ball material:** Parts may have multiple material finish options. Finish options are separated by a vertical ruled line. Lead finish/Ball material values may wrap to two lines if the finish value exceeds the maximum column width.

(5) **MSL rating/Peak reflow:** The moisture sensitivity level ratings and peak solder (reflow) temperatures. In the event that a part has multiple moisture sensitivity ratings, only the lowest level per JEDEC standards is shown. Refer to the shipping label for the actual reflow temperature that will be used to mount the part to the printed circuit board.

(6) **Part marking:** There may be an additional marking, which relates to the logo, the lot trace code information, or the environmental category of the part.

Multiple part markings will be inside parentheses. Only one part marking contained in parentheses and separated by a "-" will appear on a part. If a line is indented then it is a continuation of the previous line and the two combined represent the entire part marking for that device.

Important Information and Disclaimer: The information provided on this page represents TI's knowledge and belief as of the date that it is provided. TI bases its knowledge and belief on information provided by third parties, and makes no representation or warranty as to the accuracy of such information. Efforts are underway to better integrate information from third parties. TI has taken and continues to take reasonable steps to provide representative and accurate information but may not have conducted destructive testing or chemical analysis on incoming materials and chemicals. TI and TI suppliers consider certain information to be proprietary, and thus CAS numbers and other limited information may not be available for release.

In no event shall TI's liability arising out of such information exceed the total purchase price of the TI part(s) at issue in this document sold by TI to Customer on an annual basis.

TAPE AND REEL INFORMATION

QUADRANT ASSIGNMENTS FOR PIN 1 ORIENTATION IN TAPE

*All dimensions are nominal

Device	Package Type	Package Drawing	Pins	SPQ	Reel Diameter (mm)	Reel Width W1 (mm)	A0 (mm)	B0 (mm)	K0 (mm)	P1 (mm)	W (mm)	Pin1 Quadrant
TRF1305C1RPVR	WQFN-HR	RPV	12	3000	180.0	8.4	2.3	2.3	1.15	4.0	8.0	Q2

TAPE AND REEL BOX DIMENSIONS

*All dimensions are nominal

Device	Package Type	Package Drawing	Pins	SPQ	Length (mm)	Width (mm)	Height (mm)
TRF1305C1RPVR	WQFN-HR	RPV	12	3000	210.0	185.0	35.0

EXAMPLE BOARD LAYOUT

RPV0012A

WQFN-FCRLF - 0.7 mm max height

PLASTIC QUAD FLATPACK - NO LEAD

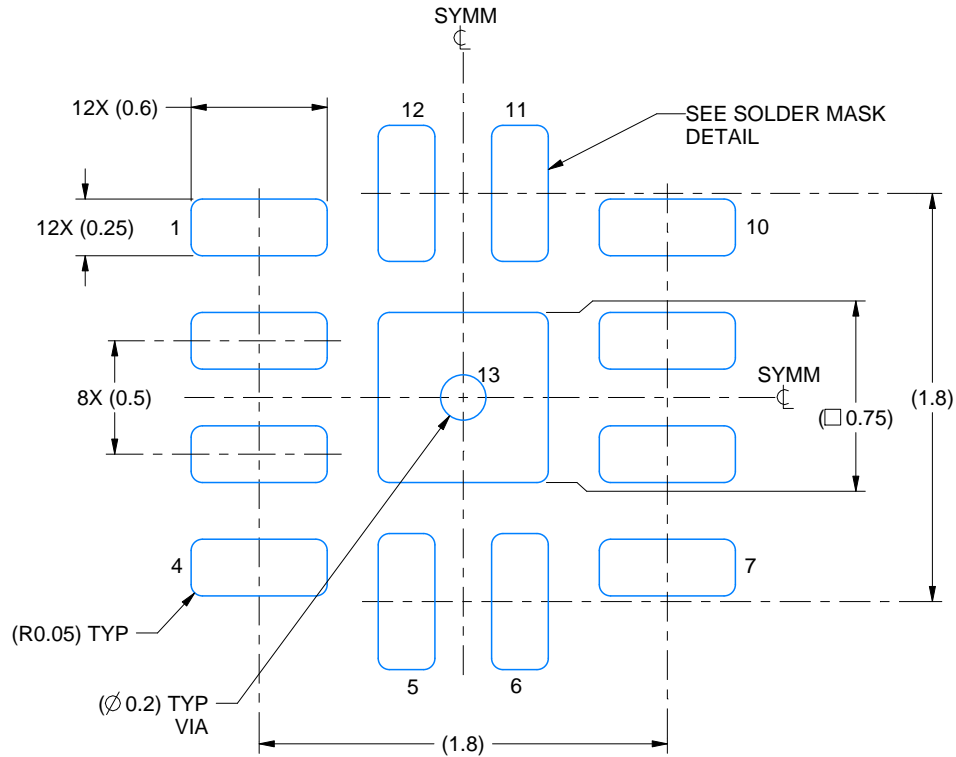

LAND PATTERN EXAMPLE
EXPOSED METAL SHOWN
SCALE: 30X

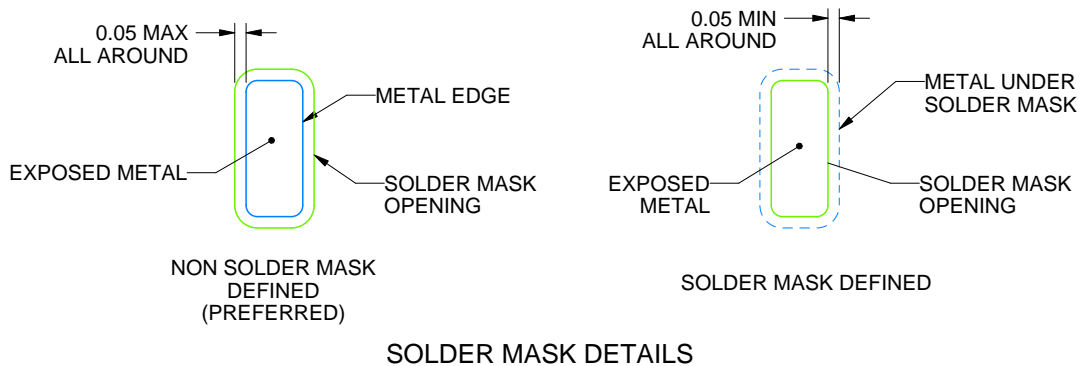

SOLDER MASK DETAILS

4225258/B 04/2020

NOTES: (continued)

4. This package is designed to be soldered to a thermal pad on the board. For more information, see Texas Instruments literature number SLUA271 (www.ti.com/lit/sluea271).
5. Vias are optional depending on application, refer to device data sheet. If any vias are implemented, refer to their locations shown on this view. It is recommended that vias under paste be filled, plugged or tented.

EXAMPLE STENCIL DESIGN

RPV0012A

WQFN-FCRLF - 0.7 mm max height

PLASTIC QUAD FLATPACK - NO LEAD

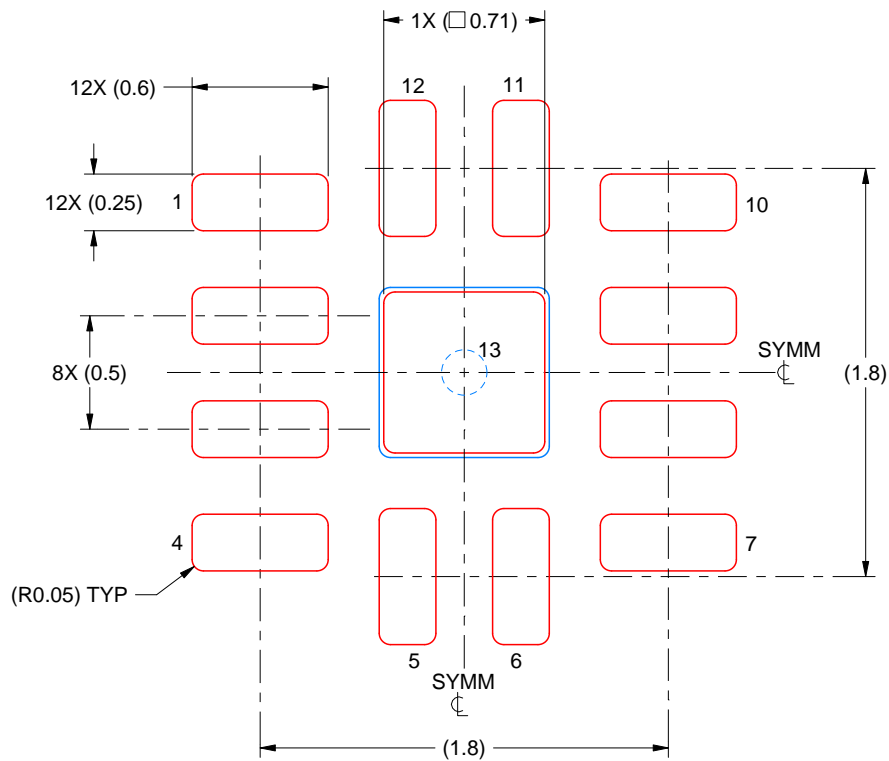

SOLDER PASTE EXAMPLE
BASED ON 0.125 MM THICK STENCIL
SCALE: 30X

EXPOSED PAD 13
90% PRINTED SOLDER COVERAGE BY AREA UNDER PACKAGE

4225258/B 04/2020

NOTES: (continued)

6. Laser cutting apertures with trapezoidal walls and rounded corners may offer better paste release. IPC-7525 may have alternate design recommendations.

IMPORTANT NOTICE AND DISCLAIMER

TI PROVIDES TECHNICAL AND RELIABILITY DATA (INCLUDING DATA SHEETS), DESIGN RESOURCES (INCLUDING REFERENCE DESIGNS), APPLICATION OR OTHER DESIGN ADVICE, WEB TOOLS, SAFETY INFORMATION, AND OTHER RESOURCES "AS IS" AND WITH ALL FAULTS, AND DISCLAIMS ALL WARRANTIES, EXPRESS AND IMPLIED, INCLUDING WITHOUT LIMITATION ANY IMPLIED WARRANTIES OF MERCHANTABILITY, FITNESS FOR A PARTICULAR PURPOSE OR NON-INFRINGEMENT OF THIRD PARTY INTELLECTUAL PROPERTY RIGHTS.

These resources are intended for skilled developers designing with TI products. You are solely responsible for (1) selecting the appropriate TI products for your application, (2) designing, validating and testing your application, and (3) ensuring your application meets applicable standards, and any other safety, security, regulatory or other requirements.

These resources are subject to change without notice. TI grants you permission to use these resources only for development of an application that uses the TI products described in the resource. Other reproduction and display of these resources is prohibited. No license is granted to any other TI intellectual property right or to any third party intellectual property right. TI disclaims responsibility for, and you will fully indemnify TI and its representatives against, any claims, damages, costs, losses, and liabilities arising out of your use of these resources.

TI's products are provided subject to [TI's Terms of Sale](#) or other applicable terms available either on [ti.com](https://www.ti.com) or provided in conjunction with such TI products. TI's provision of these resources does not expand or otherwise alter TI's applicable warranties or warranty disclaimers for TI products.

TI objects to and rejects any additional or different terms you may have proposed.

Mailing Address: Texas Instruments, Post Office Box 655303, Dallas, Texas 75265
Copyright © 2025, Texas Instruments Incorporated