

TPS22991I 5.5V, 2.7A, 28mΩ Load Switch Device With Small Plastic Package

1 Features

- Integrated single channel load switch
- Input voltage range: 1V to 5.5V
- Maximum continuous switch current: 2.7A
- Typical ON-resistance: 28mΩ
- Low quiescent current:
 - I_Q at 3.3V V_{IN} = 6μA (typical)
- Ultra-low shutdown current:
 - I_{SD} at 3.3V V_{IN} = 200nA (maximum)
- Controlled slew rate:
 - Version B, BN: rise time (t_R) at 3.3V V_{IN} = 141μs
 - Version C, CN: rise time (t_R) at 3.3V V_{IN} = 662μs
- Quick output discharge (QOD): 150Ω
- Thermal shutdown protection
- UQFN package: 0.85 × 0.75mm, 0.4mm pitch

2 Applications

- [PC and notebooks](#)
- [Wearables](#)
- [Solid state drive \(SSD\)](#)
- [Industrial PC](#)

3 Description

The TPS22991I is a small, low R_{ON} , single channel load switch with controlled slew rate. The device contains an N-channel MOSFET that operates over an input voltage range of 1.0V to 5.5V and supports a maximum continuous current of 3A. The switch is controlled by an on and off input, which is capable of interfacing directly with low-voltage control signals.

For space constrained, battery powered applications, the device is suitable due to its small size and low R_{ON} . The wide input voltage range of the switch applies to many different voltage rails. The controlled rise time of the device greatly reduces inrush current caused by large bulk load capacitances, thereby reducing or eliminating power supply droop. The TPS22991I further reduces the total solution size by integrating a 150Ω pulldown resistor for quick output discharge (QOD) when the switch is turned off.

The TPS22991I is available in a small, space saving 0.85mm × 0.75mm, 0.4mm pitch, 4-pin UQFN package. The device is characterized for operation over the free-air temperature range of -55°C to +125°C.

Package Information

PART NUMBER	PACKAGE ⁽¹⁾	PACKAGE SIZE ⁽²⁾
TPS22991I	RAA (UQFN, 4)	0.85mm × 0.75mm

- (1) For all available packages, see [Section 12](#).
 (2) The package size (length × width) is a nominal value and includes pins, where applicable.

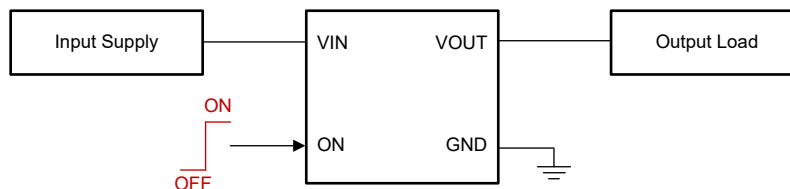

TPS22991I Typical Application



Table of Contents

1 Features	1	8.2 Functional Block Diagram.....	13
2 Applications	1	8.3 Feature Description.....	13
3 Description	1	8.4 Device Functional Modes.....	14
4 Device Comparison Table	3	9 Application and Implementation	15
5 Pin Configuration and Functions	4	9.1 Application Information.....	15
6 Specifications	5	9.2 Typical Application.....	15
6.1 Absolute Maximum Ratings.....	5	9.3 Power Supply Recommendations.....	16
6.2 ESD Ratings.....	5	9.4 Layout.....	17
6.3 Recommended Operating Conditions.....	5	10 Device and Documentation Support	18
6.4 Thermal Information.....	5	10.1 Receiving Notification of Documentation Updates..	18
6.5 Electrical Characteristics.....	6	10.2 Support Resources.....	18
6.6 Switching Characteristics (Version C, CN).....	7	10.3 Trademarks.....	18
6.7 Switching Characteristics (Version B, BN).....	7	10.4 Electrostatic Discharge Caution.....	18
6.8 Typical Characteristics.....	9	10.5 Glossary.....	18
7 Parameter Measurement Information	12	11 Revision History	18
8 Detailed Description	13	12 Mechanical, Packaging, and Orderable Information	19
8.1 Overview.....	13		

4 Device Comparison Table

Table 4-1. Functionality Comparison

PART NUMBER	QUICK OUTPUT DISCHARGE (QOD)	TURN ON TIME
TPS22991IB	Yes	Fast
TPS22991IBN	No	Fast
TPS22991IC	Yes	Slow
TPS22991ICN	No	Slow

5 Pin Configuration and Functions

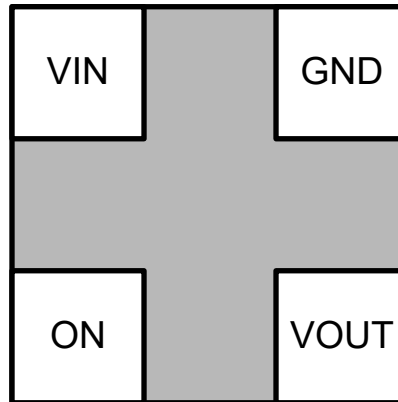

Figure 5-1. TPS22991 RAA Package, 4-Pin UQFN (Top View)

Table 5-1. Pin Functions

PIN		I/O	DESCRIPTION
NAME	NO.		
VIN	1	I	Switch input.
ON	2	I	Active high switch control input.
VOUT	3	O	Switch output.
GND	4	—	Device ground.

6 Specifications

6.1 Absolute Maximum Ratings

Over operating free-air temperature range (unless otherwise noted)⁽¹⁾

		MIN	MAX	UNIT
V _{IN}	Maximum input voltage range	-0.3	6	V
V _{OUT}	Maximum output voltage range	-0.3	6	V
V _{ON}	Maximum ON pin voltage range	-0.3	6	V
I _{MAX}	Maximum continuous current		3	A
I _{PLS}	Maximum pulsed current (2ms, 2% duty cycle)		4	A
T _J	Junction temperature	-55	150	°C
T _{STG}	Storage temperature	-65	150	°C
T _{LEAD}	Maximum lead temperature (10s soldering time)		300	°C

- (1) Operation outside the *Absolute Maximum Ratings* may cause permanent device damage. *Absolute Maximum Ratings* do not imply functional operation of the device at these or any other conditions beyond those listed under *Recommended Operating Conditions*. If used outside the *Recommended Operating Conditions* but within the *Absolute Maximum Ratings*, the device may not be fully functional, and this may affect device reliability, functionality, performance, and shorten the device lifetime.

6.2 ESD Ratings

			VALUE	UNIT
V _(ESD)	Electrostatic discharge	Human body model (HBM), per ANSI/ESDA/ JEDEC JS-001, all pins ⁽¹⁾	±1750	V
		Charged device model (CDM), per JEDEC specification JESD22-C101, all pins ⁽²⁾	±1000	

- (1) JEDEC document JEP155 states that 500V HBM allows safe manufacturing with a standard ESD control process.
 (2) JEDEC document JEP157 states that 250V CDM allows safe manufacturing with a standard ESD control process. Manufacturing with less is possible with the necessary precautions. Pins listed may actually have higher performance.

6.3 Recommended Operating Conditions

over operating free-air temperature range (unless otherwise noted)

		MIN	TYP	MAX	UNIT
V _{IN}	Input voltage range	1.0		5.5	V
V _{OUT}	Output voltage range	0		5.5	V
V _{IH}	ON pin high voltage Range	0.8		5.5	V
V _{IL}	ON pin low voltage range	0		0.35	V
T _A	Ambient temperature	-55		125	°C

6.4 Thermal Information

THERMAL METRIC ⁽¹⁾		TPS22991		UNIT
		4 PINS		
		RAA		
R _{θJA}	Junction-to-ambient thermal resistance	225.3		°C/W
R _{θJC(top)}	Junction-to-case (top) thermal resistance	214.5		°C/W
R _{θJB}	Junction-to-board thermal resistance	83.6		°C/W
Ψ _{JT}	Junction-to-top characterization parameter	13.1		°C/W
Ψ _{JB}	Junction-to-board characterization parameter	83		°C/W

- (1) For more information about traditional and new thermal metrics, see the [Semiconductor and IC Package Thermal Metrics application note](#).

6.5 Electrical Characteristics

Typical values at $V_{IN} = 3.3V$ unless otherwise specified

PARAMETER		TEST CONDITIONS		T_A	MIN	TYP	MAX	UNIT	
INPUT SUPPLY (VIN)									
$I_{Q, VIN}$	VIN quiescent current	$V_{ON} \geq V_{IH}$, $V_{OUT} = \text{Open}$		25°C		6		μA	
				-40°C to 85°C			12	μA	
				-55°C to 125°C			14	μA	
$I_{SD, VIN}$	VIN shutdown current	$V_{ON} \leq V_{IL}$, $V_{OUT} = \text{Open}$		25°C		9		nA	
				-40°C to 85°C			0.3	μA	
				-55°C to 125°C			1.2	μA	
$I_{SD, VIN}$	VIN shutdown current	$V_{ON} \leq V_{IL}$, $V_{OUT} = \text{GND}$	$V_{ON} \leq V_{IL}$, $V_{OUT} = \text{GND}$	25°C		9		nA	
				-40°C to 85°C			0.3	μA	
				-55°C to 125°C			1.2	μA	
ON-RESISTANCE (RON)									
R_{ON}	ON-state resistance	$I_{OUT} = -200mA$		$V_{IN} = 5V$	25°C		25	m Ω	
					-40°C to 85°C			35	m Ω
					-40°C to 105°C			38	m Ω
					-55°C to 125°C			40	m Ω
				$V_{IN} = 3.3V$	25°C		25	m Ω	
					-40°C to 85°C			35	m Ω
					-40°C to 105°C			38	m Ω
					-55°C to 125°C			40	m Ω
				$V_{IN} = 1.8V$	25°C		25	m Ω	
					-40°C to 85°C			35	m Ω
					-40°C to 105°C			38	m Ω
					-55°C to 125°C			40	m Ω
				$V_{IN} = 1V$	25°C		42	m Ω	
					-40°C to 85°C			64	m Ω
					-40°C to 105°C			66	m Ω
					-55°C to 125°C			73	m Ω
THERMAL SHUTDOWN (TSD)									
$T_{SD,R}$	Thermal shutdown			Rising		170		°C	
$T_{SD,F}$	Thermal shutdown			Falling		150		°C	
ENABLE PIN (ON)									
I_{ON}	ON pin leakage	$V_{ON} \geq V_{IH}$		-55°C to 125°C		100		nA	
$R_{PD, ON}$	Smart pull down resistance	$V_{ON} \leq V_{IL}$		-55°C to 125°C		500		k Ω	
$V_{IH, ON}$	ON pin threshold (V_{IH} rising)			-55°C to 125°C		0.8		V	
$V_{Hys, ON}$	ON pin threshold (hysteresis)			-55°C to 125°C		0.07		V	
$V_{IL, ON}$	ON pin threshold (V_{IL} falling)			-55°C to 125°C	0.35			V	
QUICK OUTPUT DISCHARGE (QOD)									
R_{QOD}	QOD pin internal discharge resistance (Version B, C)	$V_{ON} \leq V_{IL}$		$V_{IN} = 1V$	-55°C to 125°C		190	Ω	
				$V_{IN} = 3.3V$	-55°C to 125°C		150	Ω	
				$V_{IN} = 5V$	-55°C to 125°C		140	Ω	

6.6 Switching Characteristics (Version C, CN)

Unless otherwise noted, the typical characteristics in the following table apply to an input voltage of 3.3V, an ambient temperature of 25°C, and a load of $CL = 0.1\mu F$, $RL = 10\Omega$. Timing parameter measurement details are shown in the timing diagram in the data sheet. Parameter not tested in production

PARAMETER		TEST CONDITIONS	MIN	TYP	MAX	UNIT
t_{ON}	Turn ON time	VIN = 5.0V		1119		μs
		VIN = 3.3V		996		μs
		VIN = 1.8V		853		μs
		VIN = 1.0V		774		μs
t_R	Output rise time	VIN = 5.0V		794		μs
		VIN = 3.3V		662		μs
		VIN = 1.8V		514		μs
		VIN = 1.0V		397		μs
t_D	Delay time	VIN = 5.0V		332		μs
		VIN = 3.3V		341		μs
		VIN = 1.8V		346		μs
		VIN = 1.0V		383		μs
t_{OFF}	Turn OFF time	VIN = 5.0V		6		μs
		VIN = 3.3V		4		μs
		VIN = 1.8V		2		μs
		VIN = 1.0V		4		μs
t_F	Output Fall time	VIN = 5.0V		5		μs
		VIN = 3.3V		5		μs
		VIN = 1.8V		5		μs
		VIN = 1.0V		5		μs

6.7 Switching Characteristics (Version B, BN)

Unless otherwise noted, the typical characteristics in the following table apply to an input voltage of 3.3V, an ambient temperature of 25°C, and a load of $CL = 0.1\mu F$, $RL = 10\Omega$. Timing parameter measurement details are shown in the timing diagram in the data sheet. Parameter not tested in production

PARAMETER		TEST CONDITIONS	MIN	TYP	MAX	UNIT
t_{ON}	Turn ON time	VIN = 5.0V		302		μs
		VIN = 3.3V		259		μs
		VIN = 1.8V		216		μs
		VIN = 1.0V		198		μs
t_R	Output rise time	VIN = 5.0V		173		μs
		VIN = 3.3V		141		μs
		VIN = 1.8V		107		μs
		VIN = 1.0V		90		μs
t_D	Delay time	VIN = 5.0V		127		μs
		VIN = 3.3V		117		μs
		VIN = 1.8V		109		μs
		VIN = 1.0V		116		μs
t_{OFF}	Turn OFF time	VIN = 5.0V		6		μs
		VIN = 3.3V		4		μs
		VIN = 1.8V		2		μs
		VIN = 1.0V		4		μs

6.7 Switching Characteristics (Version B, BN) (continued)

Unless otherwise noted, the typical characteristics in the following table apply to an input voltage of 3.3V, an ambient temperature of 25°C, and a load of $CL = 0.1\mu F$, $RL = 10\Omega$. Timing parameter measurement details are shown in the timing diagram in the data sheet. Parameter not tested in production

PARAMETER		TEST CONDITIONS	MIN	TYP	MAX	UNIT
t_F	Output fall time	VIN = 5.0V		5		μs
		VIN = 3.3V		5		μs
		VIN = 1.8V		5		μs
		VIN = 1.0V		5		μs

6.8 Typical Characteristics

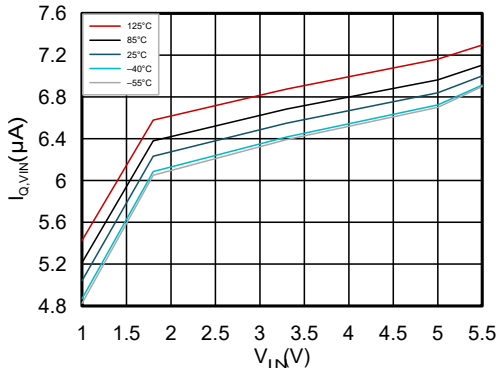
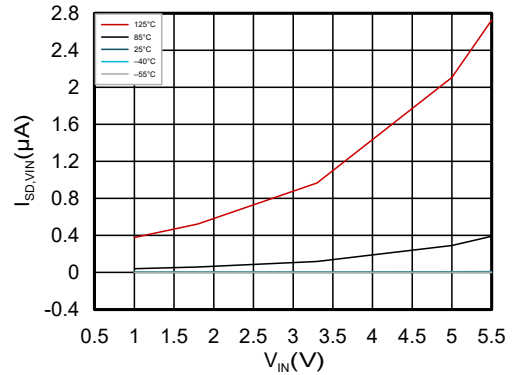
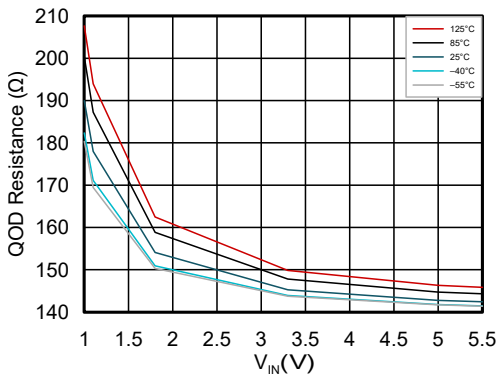

Figure 6-1. V_{IN} Quiescent Current vs Input Voltage



TPS22991B, TPS22991C

Figure 6-2. V_{IN} Shutdown Current vs Input Voltage



TPS22991B, TPS22991C

Figure 6-3. QOD Resistance vs Input Voltage

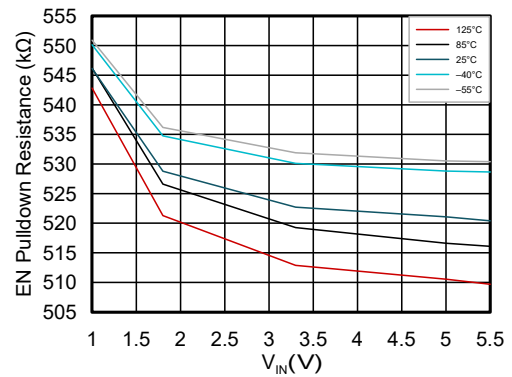

Figure 6-4. ON Pin Resistance $R_{PD,ON}$ vs Input Voltage

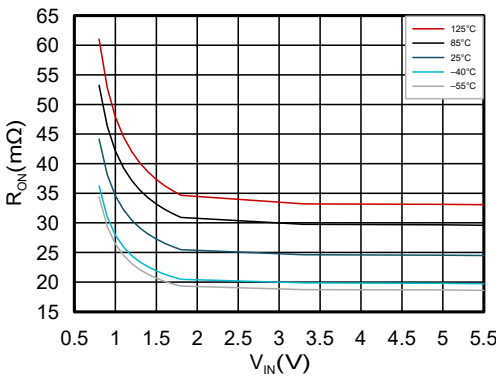
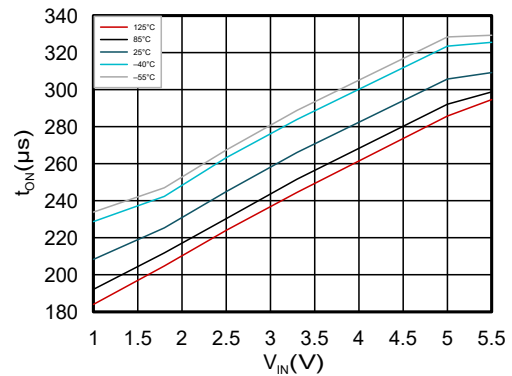

Figure 6-5. R_{ON} vs Input Voltage



$C_L = 0.1\mu F$ $R_L = 10\Omega$ TPS22991B, TPS22991BN

Figure 6-6. Turn ON Time vs Input Voltage

6.8 Typical Characteristics (continued)

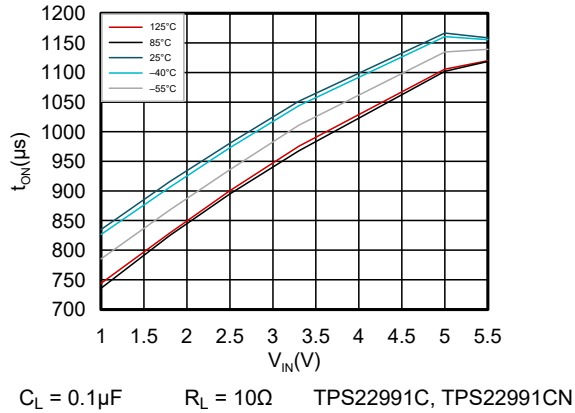

Figure 6-7. Turn ON Time vs Input Voltage

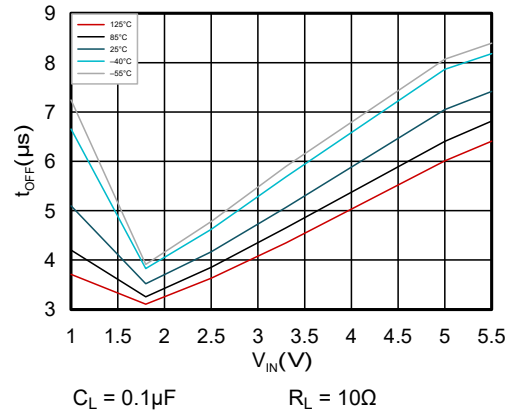

Figure 6-8. Turn OFF Time vs Input Voltage

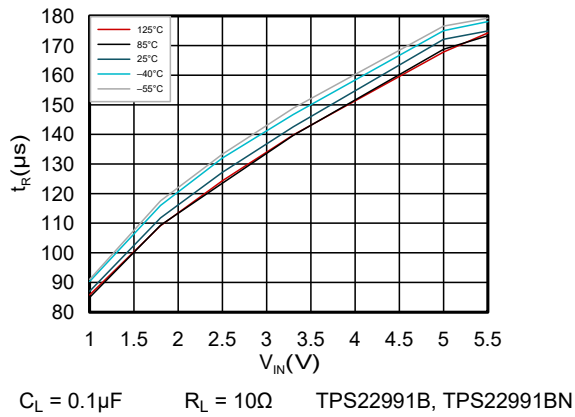

Figure 6-9. Rise Time vs Input Voltage

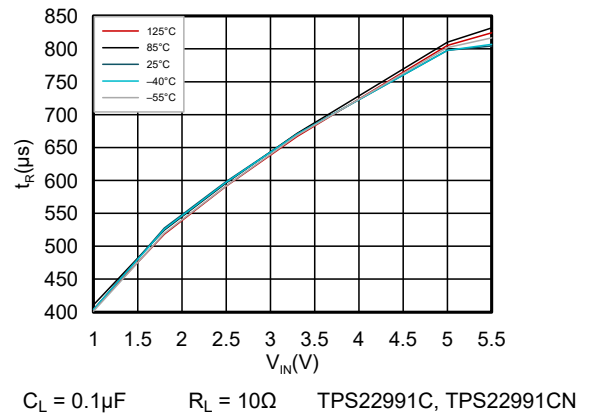

Figure 6-10. Rise Time vs Input Voltage

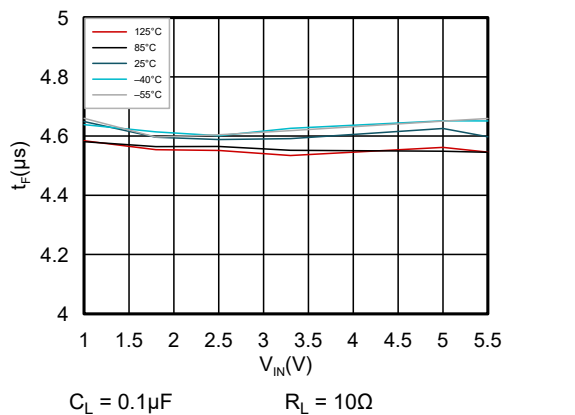

Figure 6-11. Fall Time vs Input Voltage

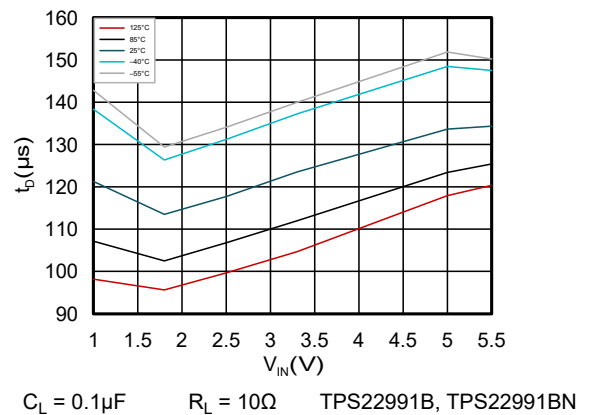

Figure 6-12. Delay Time vs Input Voltage

6.8 Typical Characteristics (continued)

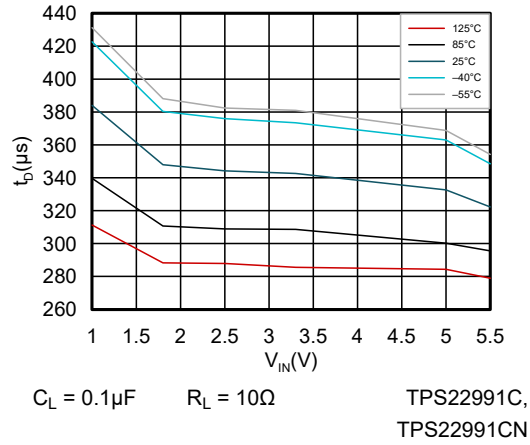

Figure 6-13. Delay Time vs Input Voltage

7 Parameter Measurement Information

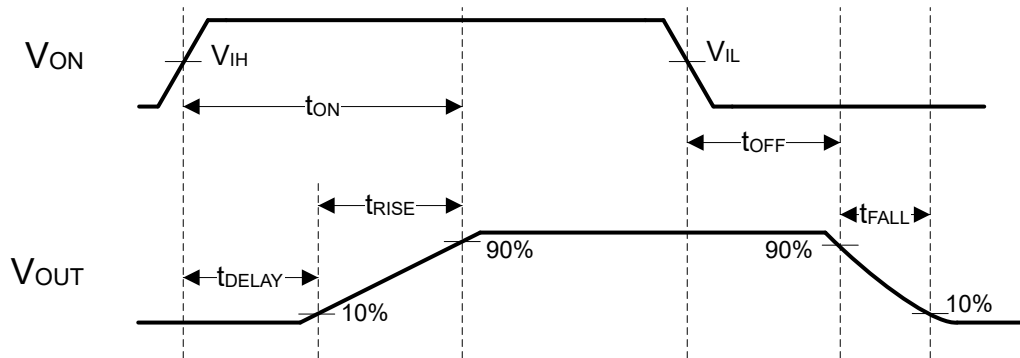

Figure 7-1. Timing Parameter Measurement Information

8 Detailed Description

8.1 Overview

The TPS22991I is a small, low R_{ON} , single channel load switch with a controlled slew rate. The device contains an N-channel MOSFET that operates over an input voltage range of 1V to 5.5V and supports a maximum continuous current of 2.7A. The switch is controlled by an on and off input, which interfaces directly with low-voltage control signals.

8.2 Functional Block Diagram

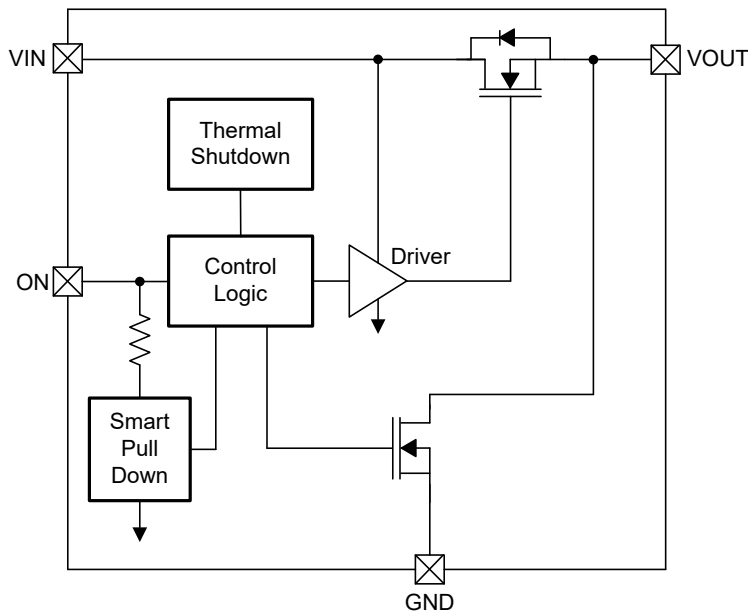

8.3 Feature Description

8.3.1 On and Off Control

The ON pin controls the state of the switch. The ON pin is compatible with standard GPIO logic threshold and is used in a wide variety of applications. When power is first applied to V_{IN} , a smart pulldown keeps the ON pin from floating until the system sequencing is complete. After the ON pin is deliberately driven high ($\geq V_{IH}$), the smart pulldown disconnects to prevent unnecessary power loss. See [Table 8-1](#) when the ON pin smart pulldown is active.

Table 8-1. On Pin Control

ON PIN VOLTAGE	ON PIN SMART PULLDOWN STATUS
$\leq V_{IL}$	Smart pulldown resistance active
$\geq V_{IH}$	Smart pulldown disconnected

8.3.2 Quick Output Discharge

TPS22991IB and TPS22991IC integrates quick output discharge. When the switch is disabled, a discharge resistor is connected between VOUT and GND. This resistor has a typical value of 150 Ω when $V_{IN} = 3.3V$, and prevents the output from floating while the switch is disabled.

8.3.3 Thermal Shutdown

When the device temperature reaches $T_{SD,R}$, the device shuts off to prevent thermal damage. After the device cools off to $T_{SD,F}$, the device turns back on. If the device is kept in a thermally stressful environment, then the device oscillates between the off and on states until the device temperature remains below the thermal shutdown point.

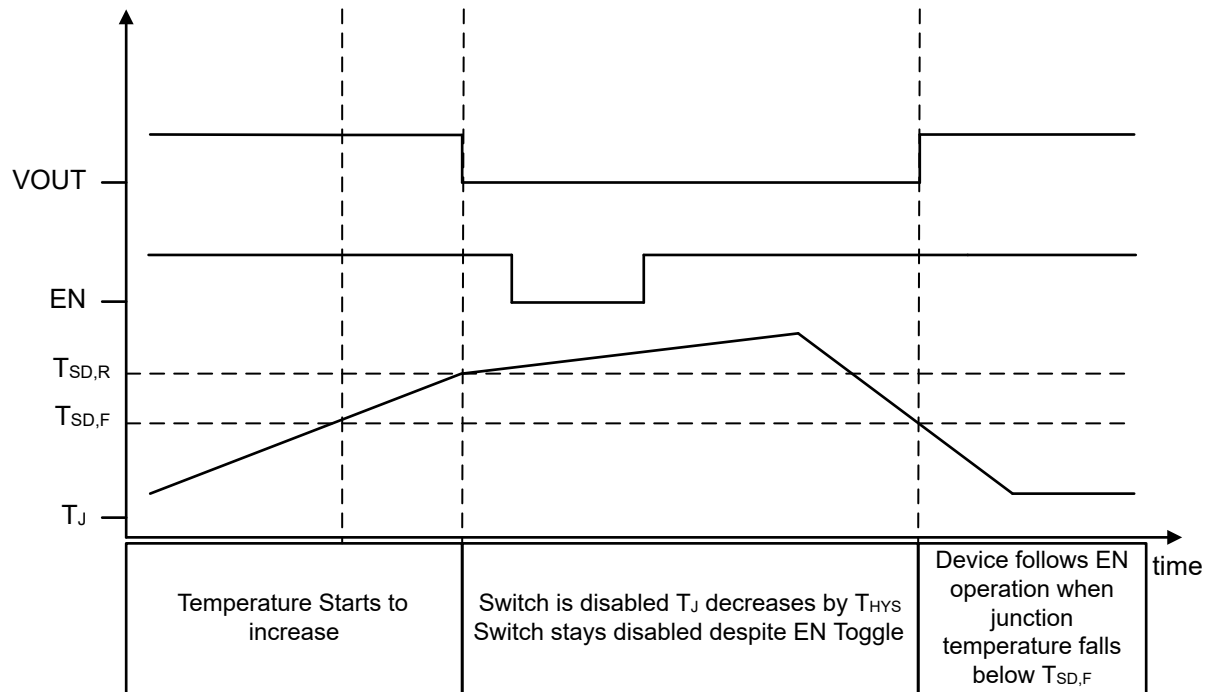

8.3.4 Input Capacitor (C_{IN})

To limit the voltage drop on the input supply caused by transient in-rush currents when the switch turns on into a discharged load capacitor or short-circuit, a capacitor needs to be placed between V_{IN} and GND. A 1µF ceramic capacitor, C_{IN}, placed close to the pins, is usually sufficient. Higher values of C_{IN} can be used to further reduce the voltage drop during high-current application. When switching heavy loads, it is recommended to have an input capacitor about 10 times higher than the output capacitor to avoid excessive voltage drop.

8.3.5 Output Capacitor (C_L)

Due to the integrated body diode in the MOSFET, a C_{IN} greater than C_L is highly recommended. A C_L greater than C_{IN} can cause V_{OUT} to exceed V_{IN} when the system supply is removed, resulting in current flow through the body diode from V_{OUT} to V_{IN}. A C_{IN} to C_L ratio of 10 to 1 is recommended for minimizing V_{IN} dip caused by inrush currents during start-up.

8.4 Device Functional Modes

The table below describes the connection of the VOUT pin depending on the state of the ON pin.

Table 8-2. VOUT Pin State Due to ON Pin Status

ON	FAULT CONDITION	VOUT STATE
L	N/A	<ul style="list-style-type: none"> Hi-Z for BN, CN GND through QOD resistor for B, C
H	None	V _{IN} through R _{ON}
X	Thermal shutdown	<ul style="list-style-type: none"> Hi-Z for BN, CN GND through QOD resistor for B, C

9 Application and Implementation

Note

Information in the following applications sections is not part of the TI component specification, and TI does not warrant its accuracy or completeness. TI's customers are responsible for determining suitability of components for their purposes, as well as validating and testing their design implementation to confirm system functionality.

9.1 Application Information

The TPS22991I is capable of driving loads up to 2.7A, and the integrated slew rate control helps with charging load capacitance. Calculate the voltage drop to estimate the power dissipation across the device. Use the slew rate control setting to estimate the inrush current during turn on.

9.2 Typical Application

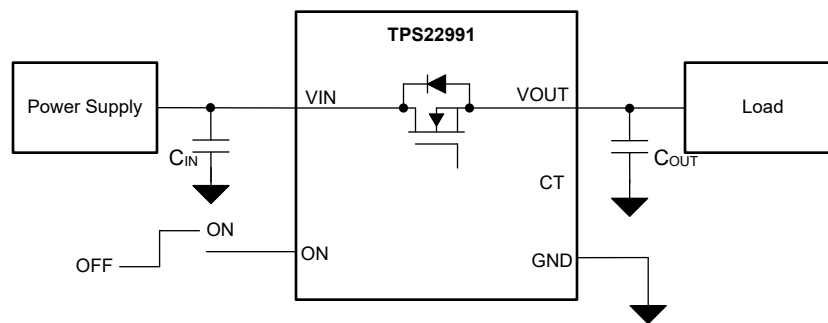

Figure 9-1. Typical Application Diagram

Table 9-1. Recommended External Components

COMPONENT	TYPICAL VALUE	PURPOSE
C _{IN}	1μF	Filtering voltage transients
C _{OUT}	100nF	Filtering voltage transients

9.2.1 Design Requirements

For this design example, use the input parameters shown in [Table 9-2](#).

Table 9-2. Design Parameters

DESIGN PARAMETER	EXAMPLE VALUE
V _{IN}	5V
Load current	2A
Load capacitance	10μF

9.2.2 Detailed Design Procedure

The input to output voltage drop in the device is determined by the R_{ON} of the device and the load current. The R_{ON} of the device depends upon the V_{IN} condition of the device. After the R_{ON} of the device is determined based upon the V_{IN} condition, use the below equation to calculate the input to output voltage drop.

$$\Delta V = I_{LOAD} \times R_{ON} \quad (1)$$

where

- ΔV is the voltage drop from V_{IN} to V_{OUT}
- I_{LOAD} is the load current

- R_{ON} is the on-resistance of the device for a specific V_{IN} and V_{BIAS}

An appropriate I_{LOAD} must be chosen such that the I_{MAX} specification of the device is not violated.

To determine how much inrush current is caused by the load capacitance, use [Equation 2](#).

$$I_{INRUSH} = C_L \times dV_{OUT} \div dt \quad (2)$$

where

- I_{INRUSH} is amount of inrush current caused by C_L
- C_L is the load capacitance on V_{OUT}
- dt is the rise time for V_{OUT} when the device is enabled
- dV_{OUT} is change in the V_{OUT} voltage after the device is enabled

The slew rate of the device dV_{OUT}/dt at a given V_{IN} voltage can be found in the electrical characteristic table for a given version. I_{INRUSH} has to be within the I_{MAX} and I_{PLS} limits.

9.2.3 Application Curves

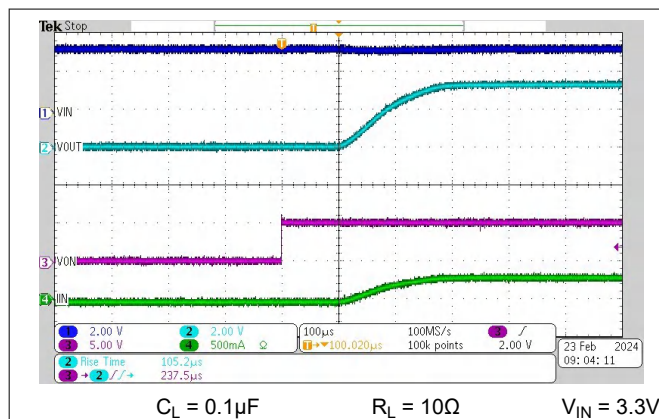

Figure 9-2. Typical Turn On for TPS22991B

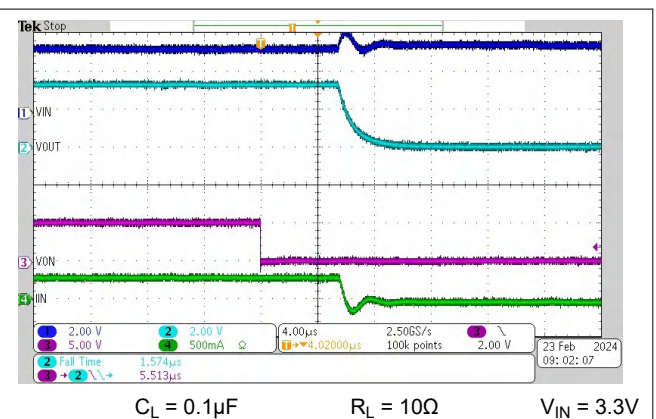

Figure 9-3. Typical Turn Off for TPS22991B

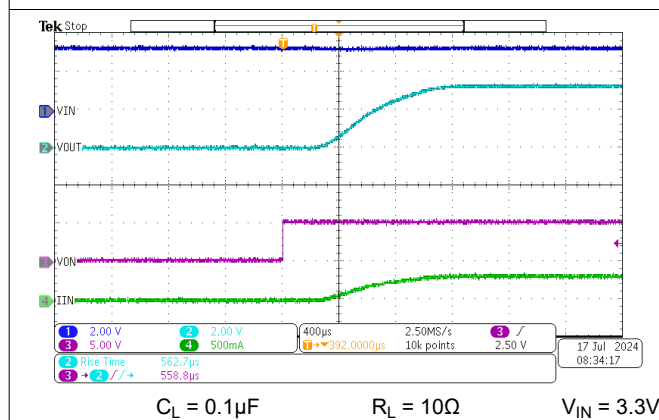

Figure 9-4. Typical Turn On for TPS22991C

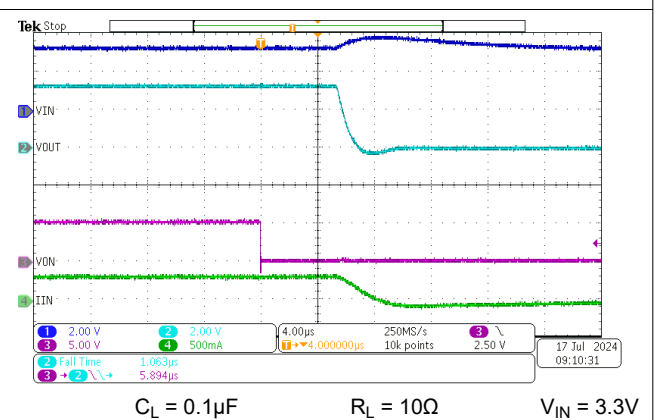

Figure 9-5. Typical Turn Off for TPS22991C

9.3 Power Supply Recommendations

The TPS22991I device is designed to operate with a V_{IN} range of 1V to 5.5V. Regulate the V_{IN} power supply well and place as close to the device terminal as possible. The power supply must be able to withstand all transient load current steps. In most situations, using an input capacitance (C_{IN}) of $1\mu\text{F}$ is sufficient to prevent the supply voltage from dipping when the switch is turned on. In cases where the power supply is slow to respond to a large transient current or large load current step, additional bulk capacitance can be required on the input.

9.4 Layout

9.4.1 Layout Guidelines

For best performance, all traces must be as short as possible. To be most effective, place the input and output capacitors close to the device to minimize the effects that parasitic trace inductances can have on normal operation. Using wide traces for VIN, VOUT, and GND helps minimize the parasitic electrical effects.

9.4.2 Layout Example

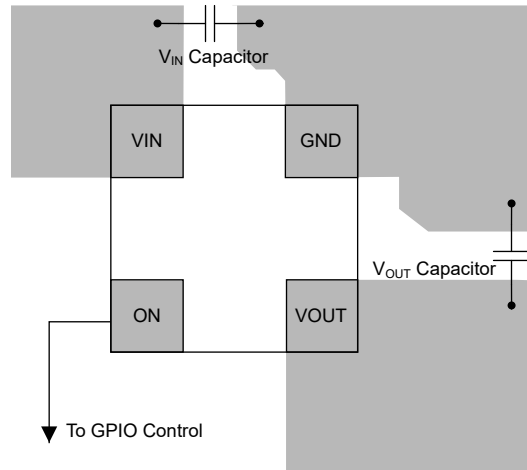

Figure 9-6. TPS22991I Layout

10 Device and Documentation Support

TI offers an extensive line of development tools. Tools and software to evaluate the performance of the device, generate code, and develop solutions are listed below.

10.1 Receiving Notification of Documentation Updates

To receive notification of documentation updates, navigate to the device product folder on ti.com. Click on *Notifications* to register and receive a weekly digest of any product information that has changed. For change details, review the revision history included in any revised document.

10.2 Support Resources

TI E2E™ [support forums](#) are an engineer's go-to source for fast, verified answers and design help — straight from the experts. Search existing answers or ask your own question to get the quick design help you need.

Linked content is provided "AS IS" by the respective contributors. They do not constitute TI specifications and do not necessarily reflect TI's views; see TI's [Terms of Use](#).

10.3 Trademarks

TI E2E™ is a trademark of Texas Instruments.

All trademarks are the property of their respective owners.

10.4 Electrostatic Discharge Caution



This integrated circuit can be damaged by ESD. Texas Instruments recommends that all integrated circuits be handled with appropriate precautions. Failure to observe proper handling and installation procedures can cause damage.

ESD damage can range from subtle performance degradation to complete device failure. Precision integrated circuits may be more susceptible to damage because very small parametric changes could cause the device not to meet its published specifications.

10.5 Glossary

[TI Glossary](#) This glossary lists and explains terms, acronyms, and definitions.

11 Revision History

NOTE: Page numbers for previous revisions may differ from page numbers in the current version.

Changes from Revision * (June 2025) to Revision A (July 2025)	Page
• Changed the document status from <i>Advance Information</i> to <i>Production Data</i>	1
• Updated <i>Application Information</i> section.....	15

12 Mechanical, Packaging, and Orderable Information

The following pages include mechanical, packaging, and orderable information. This information is the most current data available for the designated devices. This data is subject to change without notice and revision of this document. For browser-based versions of this data sheet, refer to the left-hand navigation.

PACKAGING INFORMATION

Orderable part number	Status (1)	Material type (2)	Package Pins	Package qty Carrier	RoHS (3)	Lead finish/ Ball material (4)	MSL rating/ Peak reflow (5)	Op temp (°C)	Part marking (6)
TPS22991IBNRAAR	Active	Production	null (null)	3000 LARGE T&R	Yes	SN	Level-1-260C-UNLIM	-55 to 125	4
TPS22991IBRAAR	Active	Production	null (null)	3000 LARGE T&R	Yes	SN	Level-1-260C-UNLIM	-55 to 125	S
TPS22991ICNRAAR	Active	Production	null (null)	3000 LARGE T&R	Yes	SN	Level-1-260C-UNLIM	-55 to 125	5
TPS22991ICRAAR	Active	Production	null (null)	3000 LARGE T&R	Yes	SN	Level-1-260C-UNLIM	-55 to 125	T

(1) **Status:** For more details on status, see our [product life cycle](#).

(2) **Material type:** When designated, preproduction parts are prototypes/experimental devices, and are not yet approved or released for full production. Testing and final process, including without limitation quality assurance, reliability performance testing, and/or process qualification, may not yet be complete, and this item is subject to further changes or possible discontinuation. If available for ordering, purchases will be subject to an additional waiver at checkout, and are intended for early internal evaluation purposes only. These items are sold without warranties of any kind.

(3) **RoHS values:** Yes, No, RoHS Exempt. See the [TI RoHS Statement](#) for additional information and value definition.

(4) **Lead finish/Ball material:** Parts may have multiple material finish options. Finish options are separated by a vertical ruled line. Lead finish/Ball material values may wrap to two lines if the finish value exceeds the maximum column width.

(5) **MSL rating/Peak reflow:** The moisture sensitivity level ratings and peak solder (reflow) temperatures. In the event that a part has multiple moisture sensitivity ratings, only the lowest level per JEDEC standards is shown. Refer to the shipping label for the actual reflow temperature that will be used to mount the part to the printed circuit board.

(6) **Part marking:** There may be an additional marking, which relates to the logo, the lot trace code information, or the environmental category of the part.

Multiple part markings will be inside parentheses. Only one part marking contained in parentheses and separated by a "~" will appear on a part. If a line is indented then it is a continuation of the previous line and the two combined represent the entire part marking for that device.

Important Information and Disclaimer: The information provided on this page represents TI's knowledge and belief as of the date that it is provided. TI bases its knowledge and belief on information provided by third parties, and makes no representation or warranty as to the accuracy of such information. Efforts are underway to better integrate information from third parties. TI has taken and continues to take reasonable steps to provide representative and accurate information but may not have conducted destructive testing or chemical analysis on incoming materials and chemicals. TI and TI suppliers consider certain information to be proprietary, and thus CAS numbers and other limited information may not be available for release.

In no event shall TI's liability arising out of such information exceed the total purchase price of the TI part(s) at issue in this document sold by TI to Customer on an annual basis.

IMPORTANT NOTICE AND DISCLAIMER

TI PROVIDES TECHNICAL AND RELIABILITY DATA (INCLUDING DATA SHEETS), DESIGN RESOURCES (INCLUDING REFERENCE DESIGNS), APPLICATION OR OTHER DESIGN ADVICE, WEB TOOLS, SAFETY INFORMATION, AND OTHER RESOURCES "AS IS" AND WITH ALL FAULTS, AND DISCLAIMS ALL WARRANTIES, EXPRESS AND IMPLIED, INCLUDING WITHOUT LIMITATION ANY IMPLIED WARRANTIES OF MERCHANTABILITY, FITNESS FOR A PARTICULAR PURPOSE OR NON-INFRINGEMENT OF THIRD PARTY INTELLECTUAL PROPERTY RIGHTS.

These resources are intended for skilled developers designing with TI products. You are solely responsible for (1) selecting the appropriate TI products for your application, (2) designing, validating and testing your application, and (3) ensuring your application meets applicable standards, and any other safety, security, regulatory or other requirements.

These resources are subject to change without notice. TI grants you permission to use these resources only for development of an application that uses the TI products described in the resource. Other reproduction and display of these resources is prohibited. No license is granted to any other TI intellectual property right or to any third party intellectual property right. TI disclaims responsibility for, and you will fully indemnify TI and its representatives against, any claims, damages, costs, losses, and liabilities arising out of your use of these resources.

TI's products are provided subject to [TI's Terms of Sale](#) or other applicable terms available either on [ti.com](https://www.ti.com) or provided in conjunction with such TI products. TI's provision of these resources does not expand or otherwise alter TI's applicable warranties or warranty disclaimers for TI products.

TI objects to and rejects any additional or different terms you may have proposed.

Mailing Address: Texas Instruments, Post Office Box 655303, Dallas, Texas 75265

Copyright © 2025, Texas Instruments Incorporated